



FEATURES

- Twin independent outputs
- Input/output isolation 1kVDC 'Hi Pot Test'
- Output/output isolation 1kVDC 'Hi Pot Test'
- Power sharing on outputs
- Efficiency to 80%
- 5V input
- One 5V output (V1)
- 5V, 12V and 15V outputs (V2)
- Internal SMD construction
- No external components required
- MTTF up to 1.6 million hours
- Custom solutions available

DESCRIPTION

The NMD series of DC-DC converters are ideally suited to applications where a potential difference exists between loads, e.g. motor control circuits. The twin outputs offer cost and space savings by consolidating two DC-DC converters into one package. All of the rated power may be drawn from a single output provided the total load does not exceed 1 watt.

SELECTION GUIDE

Order Code	Nominal Input Voltage	Output Voltage 1	Output Voltage 2	Output Current 1	Output Current 2	Efficiency	MTTF	Package Style	Recommended Alternative
	V	V	V	mA	mA				
In Production									
NMD050505SC	5	5	5	100	100	70	1615	SIP	
NMD050515SC	5	5	15	100	34	80	187	SIP	
To be discontinued									
NMD050512SC	5	5	12	100	42	80	339	SIP	Contact Murata
Discontinued									
NMD050503DC	5	5	3.3	100	152	70	1615	DIP	Contact Murata
NMD050512DC	5	5	12	100	42	80	339	DIP	NMD050512SC
NMD050515DC	5	5	15	100	34	80	187	DIP	NMD050515SC
NMD050503SC	5	5	3.3	100	152	70	1615	SIP	Contact Murata
NMD120505DC	12	5	5	100	100	70	489	DIP	Contact Murata
NMD120512DC	12	5	12	100	42	80	229	DIP	Contact Murata
NMD120505SC	12	5	5	100	100	70	489	SIP	Contact Murata
NMD050505DC	5	5	5	100	100	70	1615	DIP	NMD050505SC
NMD050509DC	5	5	9	100	56	80	669	DIP	Contact Murata
NMD050509SC	5	5	9	100	56	80	669	SIP	Contact Murata
NMD120509DC	12	5	9	100	56	80	343	DIP	Contact Murata
NMD120515DC	12	5	15	100	34	80	148	DIP	Contact Murata
NMD120509SC	12	5	9	100	56	80	343	SIP	Contact Murata
NMD120512SC	12	5	12	100	42	80	229	SIP	Contact Murata
NMD120515SC	12	5	15	100	34	80	148	SIP	Contact Murata

When operated **with** additional external load capacitance the rise time of the input voltage will determine the maximum external capacitance value for guaranteed start up. The slower the rise time of the input voltage the greater the maximum value of the additional external capacitance for reliable start up.

INPUT CHARACTERISTICS

Parameter	Conditions	Min.	Typ.	Max.	Units
Voltage range	Continuous operation, 5V input types	4.5	5.0	5.5	V

OUTPUT CHARACTERISTICS

Parameter	Conditions	Min.	Typ.	Max.	Units
Rated power	T _A =0°C to 125°C, see derating graph			1.0	W
Voltage set point accuracy	See tolerance envelope				
Line regulation	High V _{IN} to Low V _{IN} All output types		1.0	1.2	%/%
Load regulation	10% load to rated load, 5V output types			15	%
	10% load to rated load, 12V output types			10	
	10% load to rated load, 15V output types			10	
Ripple and noise	BW=DC to 20MHz, all output types			75	mV p-p

ISOLATION CHARACTERISTICS

Parameter	Conditions	Min.	Typ.	Max.	Units
Isolation test voltage	Flash tested for 1 second	1000			VDC
Resistance	Viso= 500VDC	1			GΩ

1. Calculated using MIL-HDBK-217F with nominal input voltage at full load.
 2. Supply voltage must be disconnected at the end of the short circuit duration.
- All specifications typical at T_A=25°C, nominal input voltage and rated output current unless otherwise specified.



For full details go to www.murata-ps.com/rohs

GENERAL CHARACTERISTICS					
Parameter	Conditions	Min.	Typ.	Max.	Units
Switching frequency	All input types		100		kHz

TEMPERATURE CHARACTERISTICS					
Parameter	Conditions	Min.	Typ.	Max.	Units
Specification	All output types	0		70	°C
Storage		-55		150	
Cooling	Free air convection				

ABSOLUTE MAXIMUM RATINGS	
Short-circuit protection ²	1 second
Wave Solder	Wave Solder profile not to exceed the profile recommended in IEC 61760-1 Section 6.1.3. Please refer to application notes for further information.
Lead temperature 1.5mm from case for 10 seconds	260°C
Input voltage V_{IN} , NMD05 types	7V

TECHNICAL NOTES**ISOLATION VOLTAGE**

'Hi Pot Test', 'Flash Tested', 'Withstand Voltage', 'Proof Voltage', 'Dielectric Withstand Voltage' & 'Isolation Test Voltage' are all terms that relate to the same thing, a test voltage, applied for a specified time, across a component designed to provide electrical isolation, to verify the integrity of that isolation.

Murata Power Solutions NMD series of DC-DC converters are all 100% production tested at their stated isolation voltage. This is 1kVDC for 1 second.

A question commonly asked is, "What is the continuous voltage that can be applied across the part in normal operation?"

For a part holding no specific agency approvals, such as the NMD series, both input and output should normally be maintained within SELV limits i.e. less than 42.4V peak, or 60VDC. The isolation test voltage represents a measure of immunity to transient voltages and the part should never be used as an element of a safety isolation system. The part could be expected to function correctly with several hundred volts offset applied continuously across the isolation barrier; but then the circuitry on both sides of the barrier must be regarded as operating at an unsafe voltage and further isolation/insulation systems must form a barrier between these circuits and any user-accessible circuitry according to safety standard requirements.

REPEATED HIGH-VOLTAGE ISOLATION TESTING

It is well known that repeated high-voltage isolation testing of a barrier component can actually degrade isolation capability, to a lesser or greater degree depending on materials, construction and environment. The NMD series has toroidal isolation transformers, with no additional insulation between primary and secondary windings of enamelled wire. While parts can be expected to withstand several times the stated test voltage, the isolation capability does depend on the wire insulation. Any material, including this enamel (typically polyurethane) is susceptible to eventual chemical degradation when subject to very high applied voltages thus implying that the number of tests should be strictly limited. We therefore strongly advise against repeated high voltage isolation testing, but if it is absolutely required, that the voltage be reduced by 20% from specified test voltage.

This consideration equally applies to agency recognised parts rated for better than functional isolation where the wire enamel insulation is always supplemented by a further insulation system of physical spacing or barriers.

RoHS COMPLIANCE INFORMATION

This series is compatible with RoHS soldering systems with a peak wave solder temperature of 260°C for 10 seconds. Please refer to [application notes](#) for further information. The pin termination finish on the SIP package type is Tin Plate, Hot Dipped over Matte Tin with Nickel Preplate. The DIP types are Matte Tin over Nickel Preplate. Both types in this series are backward compatible with Sn/Pb soldering systems.

For further information, please visit www.murata-ps.com/rohs

TOLERANCE ENVELOPES

The voltage tolerance envelope shows typical load regulation characteristics for this product series. The tolerance envelope is the maximum output voltage variation due to changes in output loading.

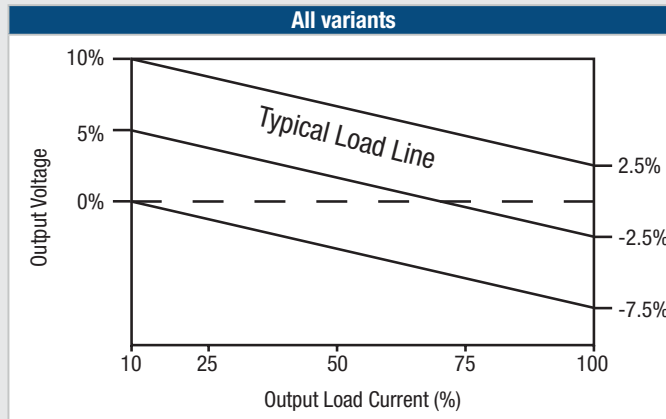

TEMPERATURE DERATING GRAPH

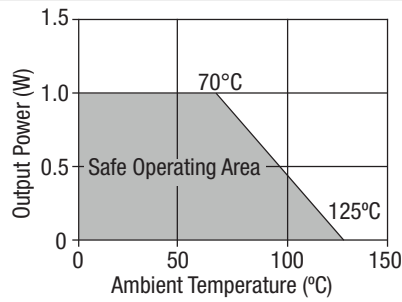

PACKAGE SPECIFICATIONS

MECHANICAL DIMENSIONS

DIP Package

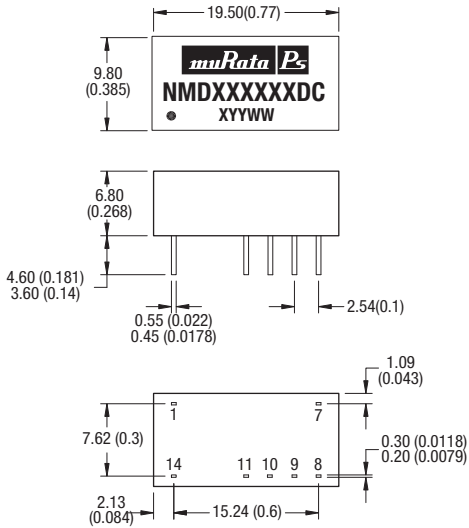

SIP Package

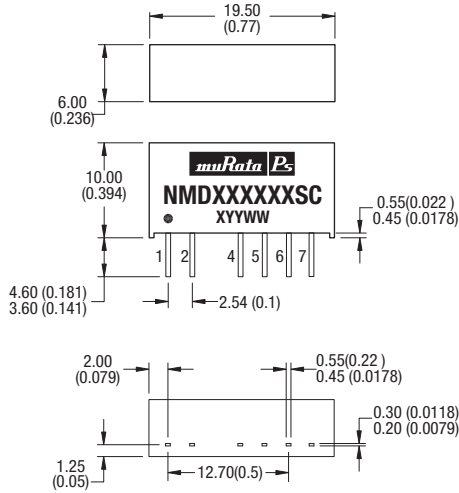

All dimensions in mm ± 0.25 mm (inches ± 0.01). All pins on a 2.54 (0.1) pitch and within 0.25 (± 0.01) of true position.

Weight: 2.3g (DIP & SIP)

PIN CONNECTIONS - 14 PIN DIP

Pin	Function
1	-VIN
7	NC
8	-VOUT2
9	+VOUT2
10	-VOUT1
11	+VOUT1
14	+VIN

PIN CONNECTIONS - 7 PIN SIP

Pin	Function
1	+VIN
2	-VIN
4	+VOUT1
5	-VOUT1
6	+VOUT2
7	-VOUT2

PACKAGE SPECIFICATIONS (Continued)

RECOMMENDED FOOTPRINT DETAILS

14 Pin DIP Package

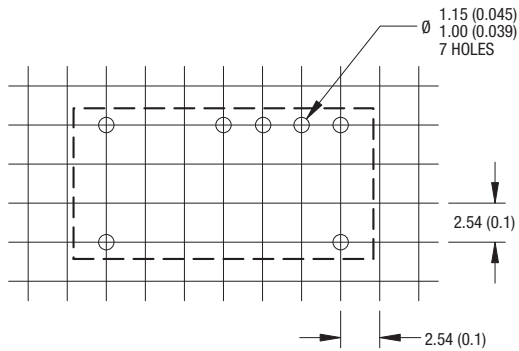

7 Pin SIP Package

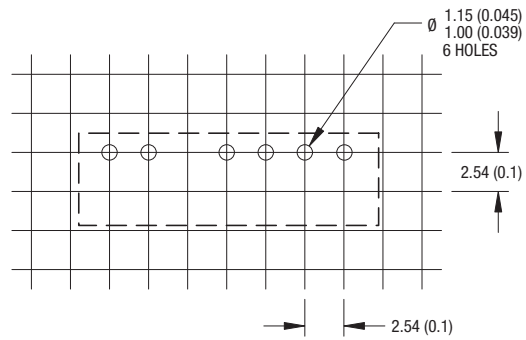

TUBE OUTLINE DIMENSIONS

14 Pin DIP Tube

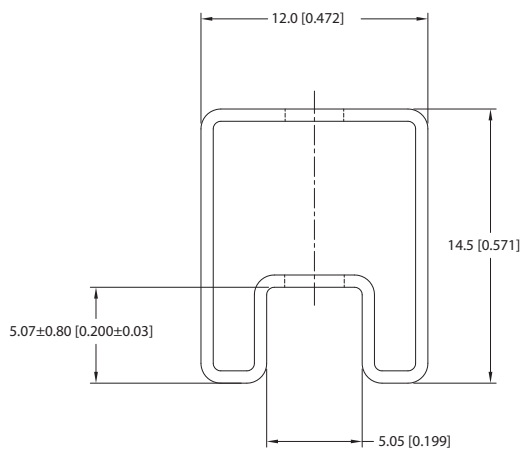

7 Pin SIP Tube

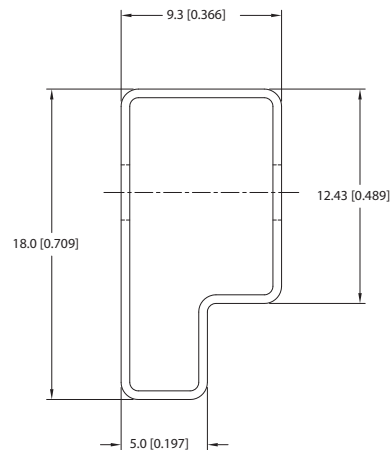

Unless otherwise specified all dimensions in mm [inches] ±0.55mm [0.022].
 Tube length (14 Pin DIP) : 520mm [20.472] ±2.0 [0.079].
 Tube length (7 Pin SIP) : 520mm [20.472] ±2.0 [0.079].

Tube Quantity : 25

DISCLAIMER

Unless otherwise stated in the datasheet, all products are designed for standard commercial and industrial applications and NOT for safety-critical and/or life-critical applications.

Particularly for safety-critical and/or life-critical applications, i.e. applications that may directly endanger or cause the loss of life, inflict bodily harm and/or loss or severe damage to equipment/property, and severely harm the environment, a prior explicit written approval from Murata is strictly required. Any use of Murata standard products for any safety-critical, life-critical or any related applications without any prior explicit written approval from Murata shall be deemed unauthorised use.

These applications include but are not limited to:

- Aircraft equipment
- Aerospace equipment
- Undersea equipment
- Power plant control equipment
- Medical equipment
- Transportation equipment (automobiles, trains, ships, etc.)
- Traffic signal equipment
- Disaster prevention / crime prevention equipment
- Data Processing equipment

Murata makes no express or implied warranty, representation, or guarantee of suitability, fitness for any particular use/purpose and/or compatibility with any application or device of the buyer, nor does Murata assume any liability whatsoever arising out of unauthorised use of any Murata product for the application of the buyer. The suitability, fitness for any particular use/purpose and/or compatibility of Murata product with any application or device of the buyer remain to be the responsibility and liability of the buyer.

Buyer represents and agrees that it has all the necessary expertise to create and implement safeguards that anticipate dangerous consequences of failures, monitor failures and their consequences, lessen the likelihood of failures that might cause harm, and take appropriate remedial actions. Buyer will fully indemnify and hold Murata, its affiliated companies, and its representatives harmless against any damages arising out of unauthorised use of any Murata products in any safety-critical and/or life-critical applications.

Remark: Murata in this section refers to Murata Manufacturing Company and its affiliated companies worldwide including, but not limited to, Murata Power Solutions.



This product is subject to the following [operating requirements](https://www.murata.com/en-eu/products/power/requirements) and the [Life and Safety Critical Application Sales Policy](https://www.murata.com/en-eu/products/power/requirements):

Refer to: <https://www.murata.com/en-eu/products/power/requirements>

Murata Power Solutions (Milton Keynes) Ltd. makes no representation that the use of its products in the circuits described herein, or the use of other technical information contained herein, will not infringe upon existing or future patent rights. The descriptions contained herein do not imply the granting of licenses to make, use, or sell equipment constructed in accordance therewith. Specifications are subject to change without notice.

© 2021 Murata Power Solutions (Milton Keynes) Ltd.