

DATA SHEET

INDUCTOR

Chip Bead

ABFJ Series

RoHS compliant & Halogen Free



Chip Bead ABFJ Series

**Automotive
AEC-Q200**

RoHS Compliant
Halogen Free
REACH Compliant



Noise
Suppression

Shield

Multilayer

Ferrite

High speed
Signal line

■ Part Numbering

| | | | | | | |
|-------|-------------|--------------|-------------------------|---------------------------|-------------|---------------|
| A | BFJ | 00 | 100505 | 601 | Y | 00 |
| Grade | Series Name | Control Code | Dimensions Code (mm) | Impedance (Ω) | Tolerance | Internal Code |
| | | | 100505 1.0x0.5x0.5 | 601 600 102 1000 | Y \pm 25% | |

This specification applies to Multilayer Chip ferrite Bead for Automotive Electronics based on AEC-Q200 except for Power train and Safety.

Chip Bead ABFJ Series

**Automotive
AEC-Q200**

ABFJ00100505 Type

■ Dimensions

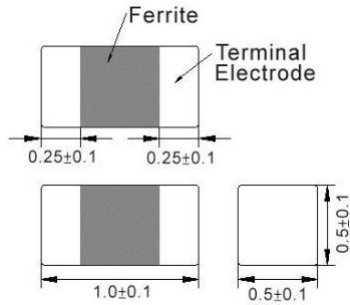

unit:mm

■ Recommended Land Pattern

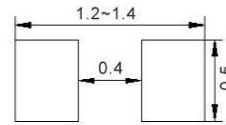

unit:mm

■ Electrical Characteristics

| Part No. | Impedance | Impedance | Test Freq. | RDC | Rated Current |
|--------------------|-------------------------|-------------------------|------------|-------|------------------|
| | (Ω) $\pm 25\%$ | (Ω) $\pm 40\%$ | | (MHz) | (Ω)Max. |
| ABFJ00100505601Y00 | 600 | 1400 | 100/1000 | 0.85 | 300 |
| ABFJ00100505102Y00 | 1000 | 2000 | 100/1000 | 1.25 | 250 |

Note: When ordering, please specify tolerance code. Tolerance: Y $\pm 25\%$

1. Operating temperature range - 40°C ~ 125°C
2. Rate Current : Applied the current to coils, the temperature rise shall not be more than 30°C
3. Measure Equipment:
Z: HP4291A
RDC: HP4338B or CHEN HWA 502

Chip Bead ABFJ Series

**Automotive
AEC-Q200**

ABFJ00100505 Type

■ Characteristics Graph

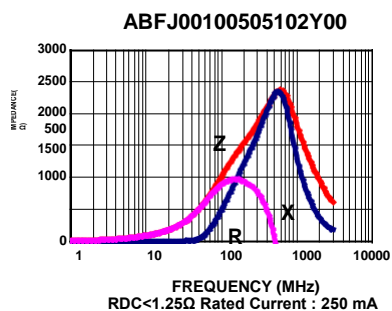
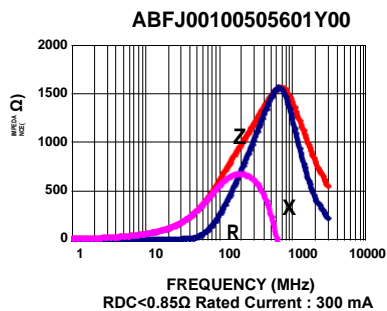

Chip Bead ABFJ Series

**Automotive
AEC-Q200**

■ Packaging

Tape Dimensions

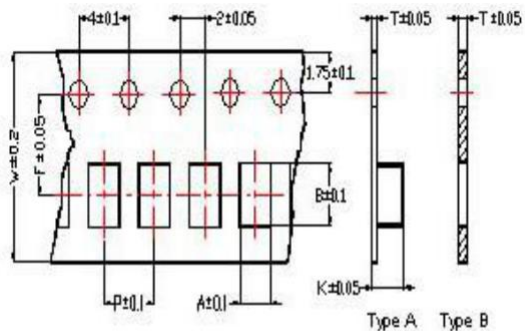

Tape Material

Carrier Tape: Polycarbonate (Tape A)
Carrier Tape: Paper (Tape B)
Cover Tape: Polystyrene

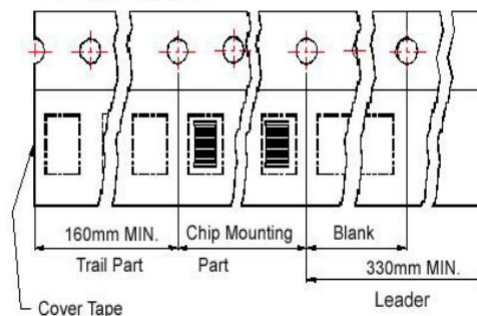

Reel Dimensions

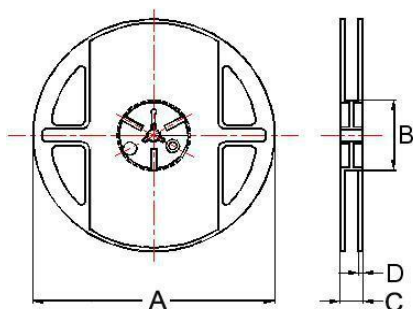

Dimensions in mm

| TYPE | Tape Dimensions | | | | | | | | Reel Dimensions | | | | Quantity PCS / Reel |
|--------------|-----------------|------|------|---|---|-----|---|------|-----------------|----|----|---|------------------------|
| | A | B | T | W | P | F | K | Tape | A | B | C | D | |
| ABFJ00100505 | 0.62 | 1.12 | 0.60 | 8 | 2 | 3.5 | - | B | 178 | 60 | 12 | 2 | 10000 |