

# DATA SHEET

## METAL OXIDE VARISTORS POWER SUPPLY

14M(E,N)TMOV series

RoHS compliant & Halogen free



Product specification— October 06, 2020 V.1



## Metal Oxide Varistor Data Sheet

### Features

- TMOV integrated thermal protection device
- High peak surge current rating up to 6KA
- Designed to facilitate compliance to UL1449 for TVSS products
- Wide operating voltage ( $V_{1mA}$ ) range from 82V to 1200V
- Rated current: 5A
- Rated Functioning Temperature: 136(°C)
- Fast responding to transient over-voltage and limited current
- Large absorbing transient energy capability
- Low clamping ratio and no follow-on current
- Three-lead version available for indication purposes
- Meets MSL level 1, per J-STD-020
- Operating Temperature: -40°C ~ +85°C
- Storage Temperature: -40°C ~ +85°C
- Safety certification: UL: E327997

### Applications

- AC power line or AC/DC supplies
- Transistor, diode, IC, thyristor or triac semiconductor protection
- Surge protection in consumer electronics
- Surge protection in industrial electronics
- Surge protection in electronic home appliances, gas and petroleum appliances
- Relay and electromagnetic valve surge absorption
- AC panel protection Modules

### Part number code

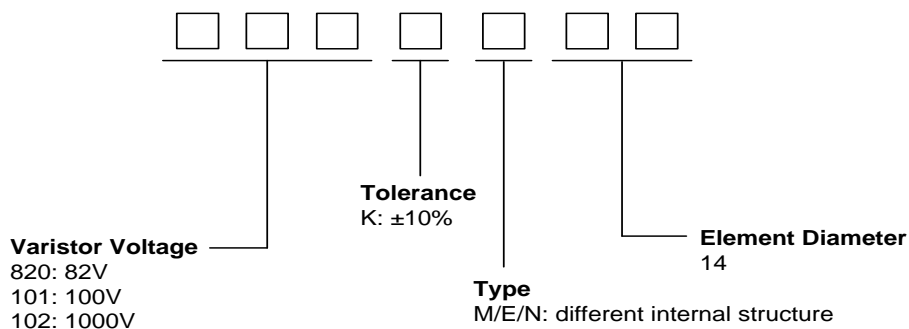

**Lead configurations and application examples**

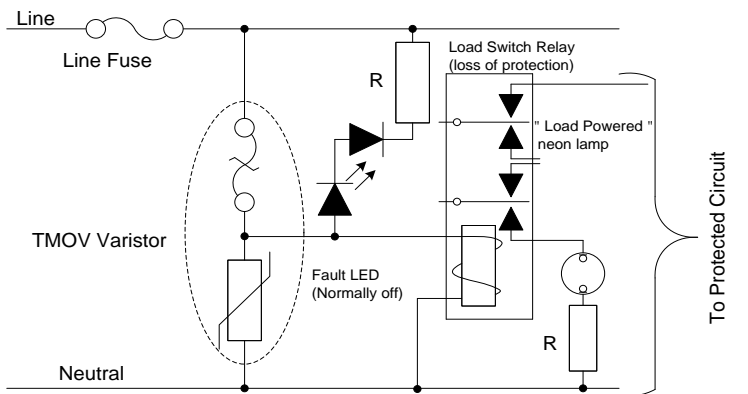
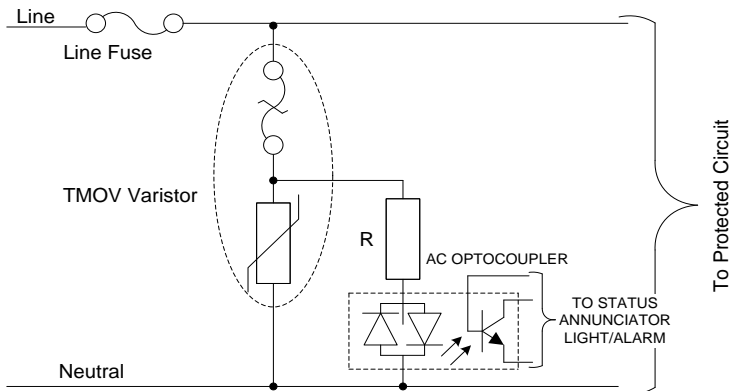
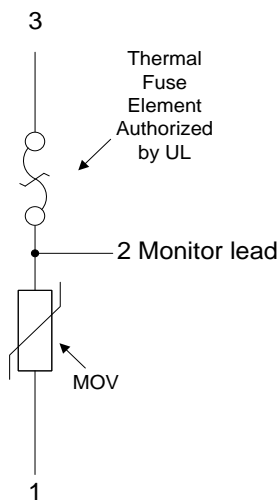
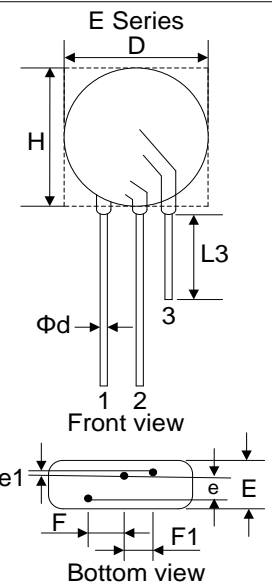
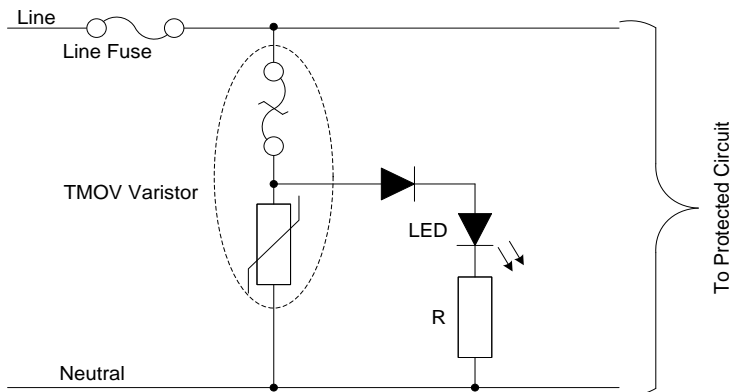
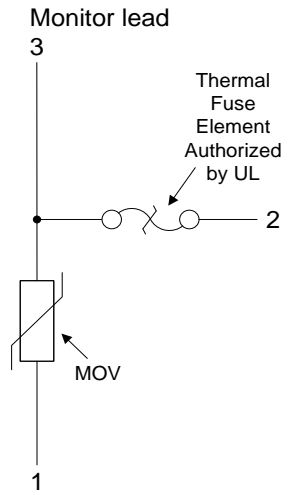
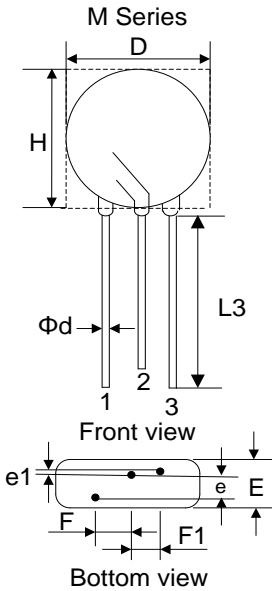
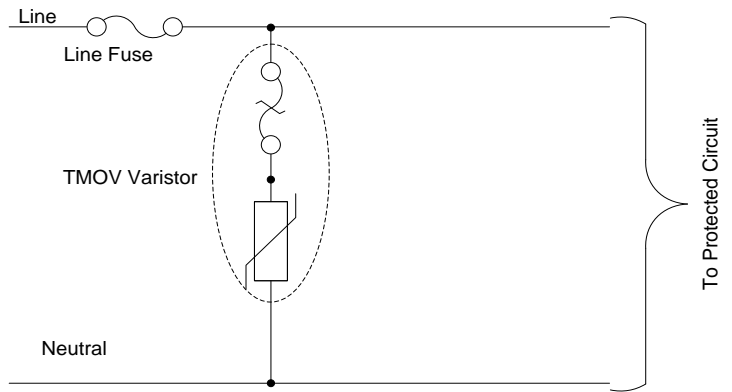
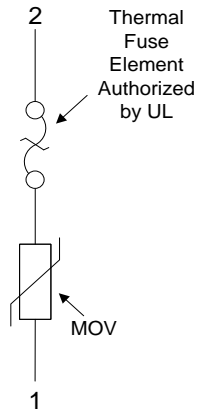
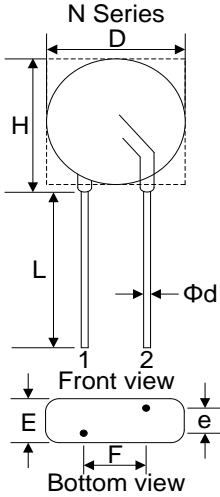

## Dimensions

Symbol		BK'S M / E / N Varistor		
		14M	14E	14N
		Unit: mm		
D (max.)		19.0	19.0	19.0
H (max.)		21.0	21.0	21.0
F ( $\pm 1.0$ )		7.5	7.5	7.5
F1 ( $\pm 1.0$ )		5.0	5.0	-
e (max.)	820K~121K	2.8	2.8	2.8
	151K~391K	3.8	3.8	3.8
	431K~621K	5.5	5.5	5.5
	681K~911K	7.8	7.8	7.8
	102K~122K	10.0	10.0	10.0
e1	820K~121K	1.3 $\pm$ 0.8	1.3 $\pm$ 0.8	-
	151K~391K			
	431K~621K			
	681K~911K			
	102K~122K			
E (max.)	820K~121K	8.8	8.8	8.8
	151K~391K	9.8	9.8	9.8
	431K~621K	11.5	11.5	11.5
	681K~911K	13.8	13.8	13.8
	102K~122K	16.0	16.0	16.0
L (min.)		20.0	20.0	20.0
L3 (min.)		10.0	10.0	-
$\Phi d$		0.8		

**Electrical characteristics**

Part Number	Maximum Allowable Voltage		Varistor Voltage $V_{1mA}(V)$	Maximum Clamping Voltage		Maximum Peak Current (8/20 $\mu$ s)		Maximum Energy (Joule)		Rated Power (W)	Typical Capacitance (Reference) @1KHz (pf)
	$V_{AC}(V)$	$V_{DC}(V)$		$I_P(A)$	$V_C(V)$	1 time	2 times	10/1000 $\mu$ s	2ms		
			(A)								
820KM(E,N)14	50	65	82(74~90)	50	135	4500	2500	27	22	0.6	2400
101KM(E,N)14	60	85	100(90~110)	50	165	4500	2500	33	28	0.6	2000
121KM(E,N)14	75	100	120(108~132)	50	200	4500	2500	40	32	0.6	1700
151KM(E,N)14	95	125	150(135~165)	50	250	6000	4500	50	35	0.6	1300
181KM(E,N)14	115	150	180(162~198)	50	300	6000	4500	58	40	0.6	1100
201KM(E,N)14	130	170	200(185~225)	50	340	6000	4500	70	50	0.6	1000
221KM(E,N)14	140	180	220(198~242)	50	365	6000	4500	78	55	0.6	900
241KM(E,N)14	150	200	240(216~264)	50	395	6000	4500	85	60	0.6	830
271KM(E,N)14	175	225	270(243~297)	50	455	6000	4500	100	70	0.6	740
301KM(E,N)14	190	250	300(270~330)	50	500	6000	4500	107	75	0.6	670
331KM(E,N)14	210	275	330(297~363)	50	550	6000	4500	115	80	0.6	610
361KM(E,N)14	230	300	360(324~396)	50	595	6000	4500	125	90	0.6	560
391KM(E,N)14	250	320	390(351~429)	50	650	6000	4500	140	100	0.6	510
431KM(E,N)14	275	350	430(387~473)	50	710	6000	4500	155	110	0.6	460
471KM(E,N)14	300	385	470(423~517)	50	775	6000	4500	175	125	0.6	430
511KM(E,N)14	320	415	510(459~561)	50	845	6000	4500	190	136	0.6	390
561KM(E,N)14	350	460	560(504~616)	50	920	6000	4500	200	140	0.6	360
621KM(E,N)14	385	505	620(558~682)	50	1025	6000	4500	210	150	0.6	320
681KM(E,N)14	420	560	680(612~748)	50	1120	6000	4500	220	155	0.6	290
751KM(E,N)14	460	615	750(675~825)	50	1240	6000	4500	225	160	0.6	270
781KM(E,N)14	485	640	780(702~858)	50	1290	6000	4500	240	165	0.6	260
821KM(E,N)14	510	670	820(738~902)	50	1355	6000	4500	245	170	0.6	240
911KM(E,N)14	550	745	910(819~1001)	50	1500	6000	4500	255	180	0.6	220
102KM(E,N)14	625	825	1000(900~1100)	50	1650	6000	4500	280	190	0.6	200
112KM(E,N)14	680	895	1100(990~1210)	50	1815	6000	4500	310	205	0.6	180
122KM(E,N)14	750	990	1200(1080~1320)	50	1980	6000	4500	338	215	0.6	150

**Electrical Ratings**

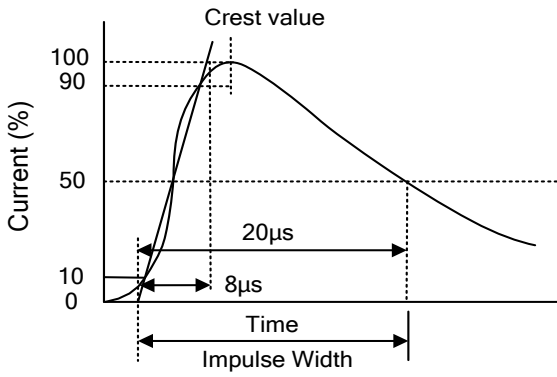
Items	Test Condition/Description	Requirement
Varistor Voltage	The voltage between two terminals with the specified measuring current 1mA.DC applied is called Vb.	To meet the Specified value
Maximum Allowable Voltage	The recommended maximum sine wave voltage (RMS) or the Maximum DC voltage can be applied continuously.	
Maximum Clamping Voltage	<p>The maximum voltage between two terminals with the specification standard impulse current. Applied waveform: 8/20µs</p> 	
Rated Wattage	The maximum average power that can be applied within the specified ambient temperature.	
Energy	The maximum energy within the varistor voltage change of ±10% when one impulse of 10/1000µs or 2ms is applied.	
Withstanding Surge Current	The maximum current within the varistor voltage change of ±10% with the standard impulse current (8/20µs) applied one time.	
Varistor Voltage Temp. Coefficient	$\left  \frac{V_{1mA@85^{\circ}C} - V_{1mA@25^{\circ}C}}{V_{1mA@25^{\circ}C}} \times \frac{1}{60} \times 100\% (\%/^{\circ}C) \right $ $\left  \frac{V_{1mA@-40^{\circ}C} - V_{1mA@25^{\circ}C}}{V_{1mA@25^{\circ}C}} \times \frac{1}{65} \times 100\% (\%/^{\circ}C) \right $	

**Mechanical Characteristics**

Items	Test conditions / Methods	Specifications								
Tensile Strength of Terminals	Gradually applying the force specified and keeping the unit fixed for 10±1 sec.  <table border="1"> <thead> <tr> <th>Terminal diameter (mm)</th> <th>Force (kg)</th> </tr> </thead> <tbody> <tr> <td>0.5&lt;d≤0.8</td> <td>1.0</td> </tr> <tr> <td>0.8&lt;d≤1.25</td> <td>2.0</td> </tr> <tr> <td>1.25&lt;d</td> <td>4.0</td> </tr> </tbody> </table>	Terminal diameter (mm)	Force (kg)	0.5<d≤0.8	1.0	0.8<d≤1.25	2.0	1.25<d	4.0	No visible damage  ΔV <sub>1mA</sub> /V <sub>1mA</sub>   ≤5%
Terminal diameter (mm)	Force (kg)									
0.5<d≤0.8	1.0									
0.8<d≤1.25	2.0									
1.25<d	4.0									
Bending Strength of Terminals	Hold specimen and apply the force specified below to each lead. Bend the specimen to 90°, then return to the original position. Repeat the procedure in the opposite direction.  <table border="1"> <thead> <tr> <th>Terminal diameter (mm)</th> <th>Force (kg)</th> </tr> </thead> <tbody> <tr> <td>0.5&lt;d≤0.8</td> <td>0.5</td> </tr> <tr> <td>0.8&lt;d≤1.25</td> <td>1.0</td> </tr> <tr> <td>1.25&lt;d</td> <td>2.0</td> </tr> </tbody> </table>	Terminal diameter (mm)	Force (kg)	0.5<d≤0.8	0.5	0.8<d≤1.25	1.0	1.25<d	2.0	No visible damage  ΔV <sub>1mA</sub> /V <sub>1mA</sub>   ≤5%
Terminal diameter (mm)	Force (kg)									
0.5<d≤0.8	0.5									
0.8<d≤1.25	1.0									
1.25<d	2.0									
Vibration	Frequency range: 10~55 Hz Amplitude: 0.75mm or 98m/s <sup>2</sup> Direction: 3 mutually perpendicular directions, 2hrs each.	No visible damage  ΔV <sub>1mA</sub> /V <sub>1mA</sub>   ≤5%								
Solder ability	Solder Temp: 245±5°C Dipping Time: 2±0.5 sec	At least 95% of terminal electrode is covered by new solder								
Resistance to Soldering Heat	Solder Temp: 260±5°C Dipping Time: ≤5 sec	No visible damage  ΔV <sub>1mA</sub> /V <sub>1mA</sub>   ≤10%								

**Reliability**

Items	Test conditions / Methods	Specifications															
High Temperature Storage	Ambient Temp: 85±2°C Duration: 1000hrs	ΔV <sub>1mA</sub> /V <sub>1mA</sub>   ≤5%															
Low Temperature Storage	Ambient Temp: -40±2°C Duration: 1000hrs	ΔV <sub>1mA</sub> /V <sub>1mA</sub>   ≤5%															
Humidity	Ambient Temp: 40±2°C, 90~95% R.H. Duration: 1000hrs	ΔV <sub>1mA</sub> /V <sub>1mA</sub>   ≤5%															
Temperature Cycle	The conditions shown below shall be repeated 5 cycles <table border="1"> <thead> <tr> <th>Step</th> <th>Temperature (°C)</th> <th>Period (minutes)</th> </tr> </thead> <tbody> <tr> <td>1</td> <td>-40±3</td> <td>30±3</td> </tr> <tr> <td>2</td> <td>Room temperature</td> <td>15±3</td> </tr> <tr> <td>3</td> <td>85±3</td> <td>30±3</td> </tr> <tr> <td>4</td> <td>Room temperature</td> <td>15±3</td> </tr> </tbody> </table>	Step	Temperature (°C)	Period (minutes)	1	-40±3	30±3	2	Room temperature	15±3	3	85±3	30±3	4	Room temperature	15±3	No visible damage  ΔV <sub>1mA</sub> /V <sub>1mA</sub>   ≤5%
Step	Temperature (°C)	Period (minutes)															
1	-40±3	30±3															
2	Room temperature	15±3															
3	85±3	30±3															
4	Room temperature	15±3															
High Temperature Load	Ambient Temp: 85±2°C      Duration: 1000hrs Load: Max. Allowable Voltage In AC eera.	ΔV <sub>1mA</sub> /V <sub>1mA</sub>   ≤10%															
Damp Heat Load	Ambient Temp: 40±2°C, 90~95% R.H. Duration: 1000hrs      Load: Max. Allowable Voltage	No visible damage  ΔV <sub>1mA</sub> /V <sub>1mA</sub>   ≤10%															
Voltage Proof	Metal balls method, 2500Vac 1 min.	No visible damage															

Maximum Leakage Current and Maximum Clamping Voltage Curve

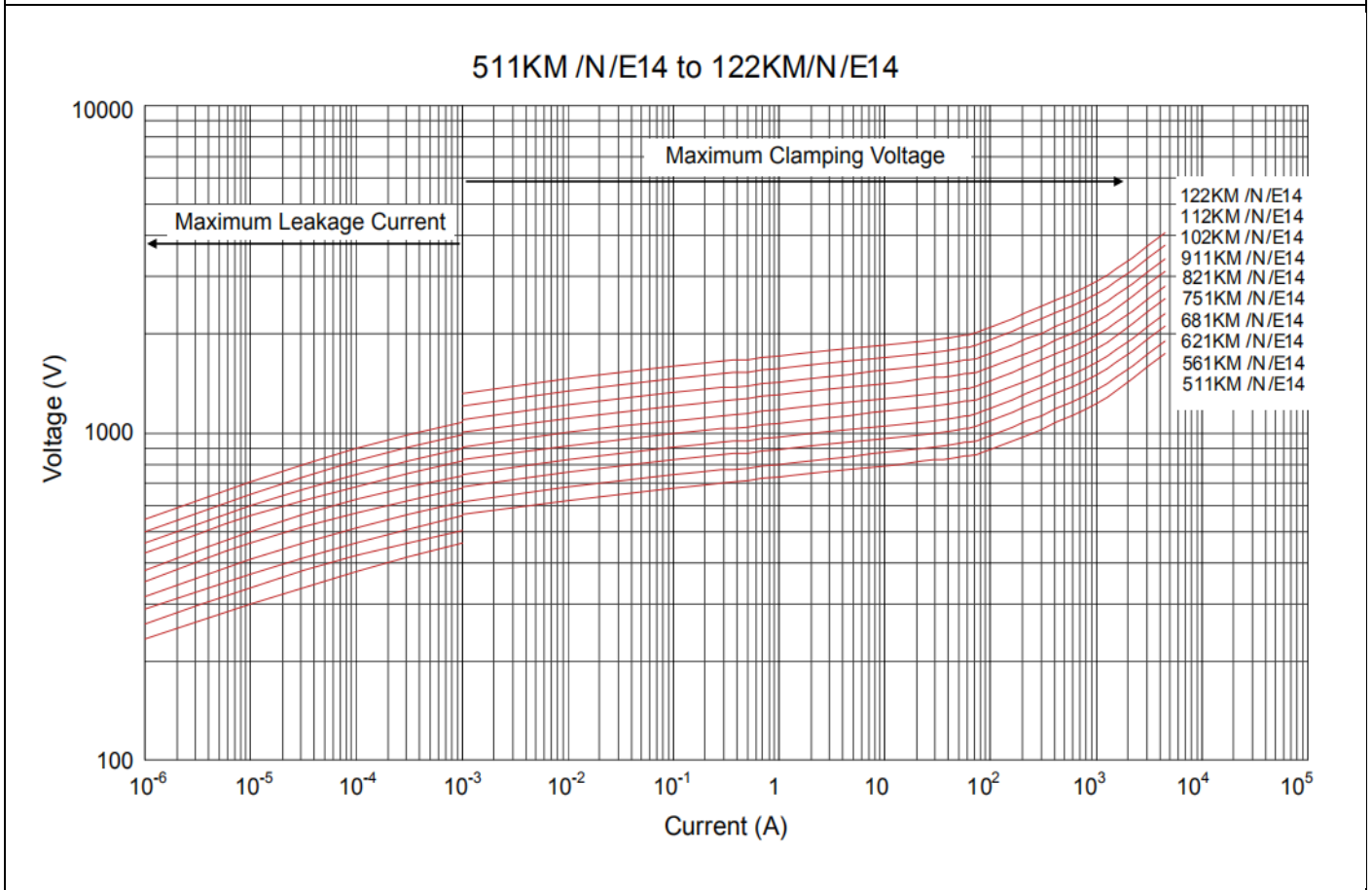
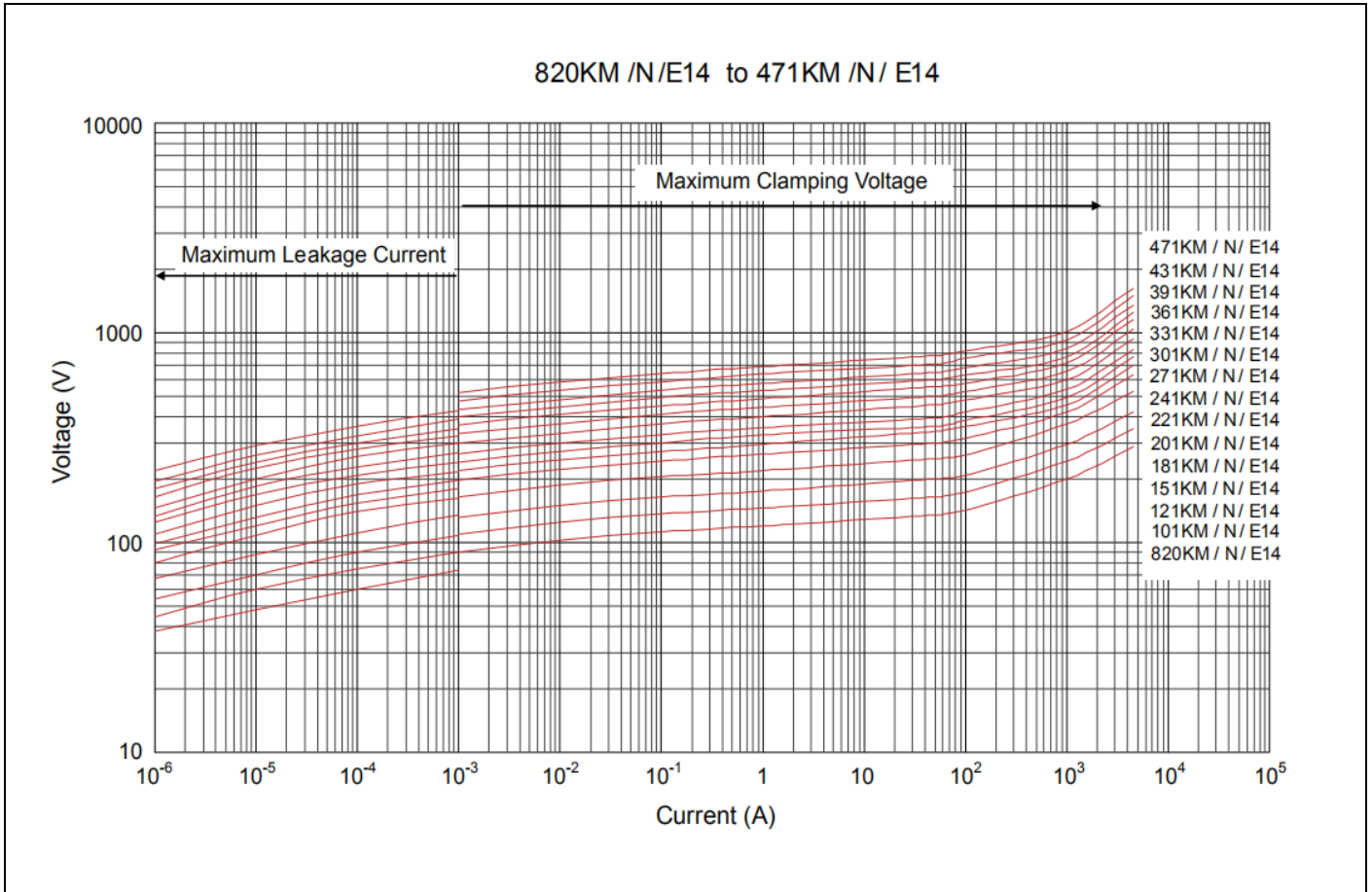



**Maximum Surge Current Derating Curve**

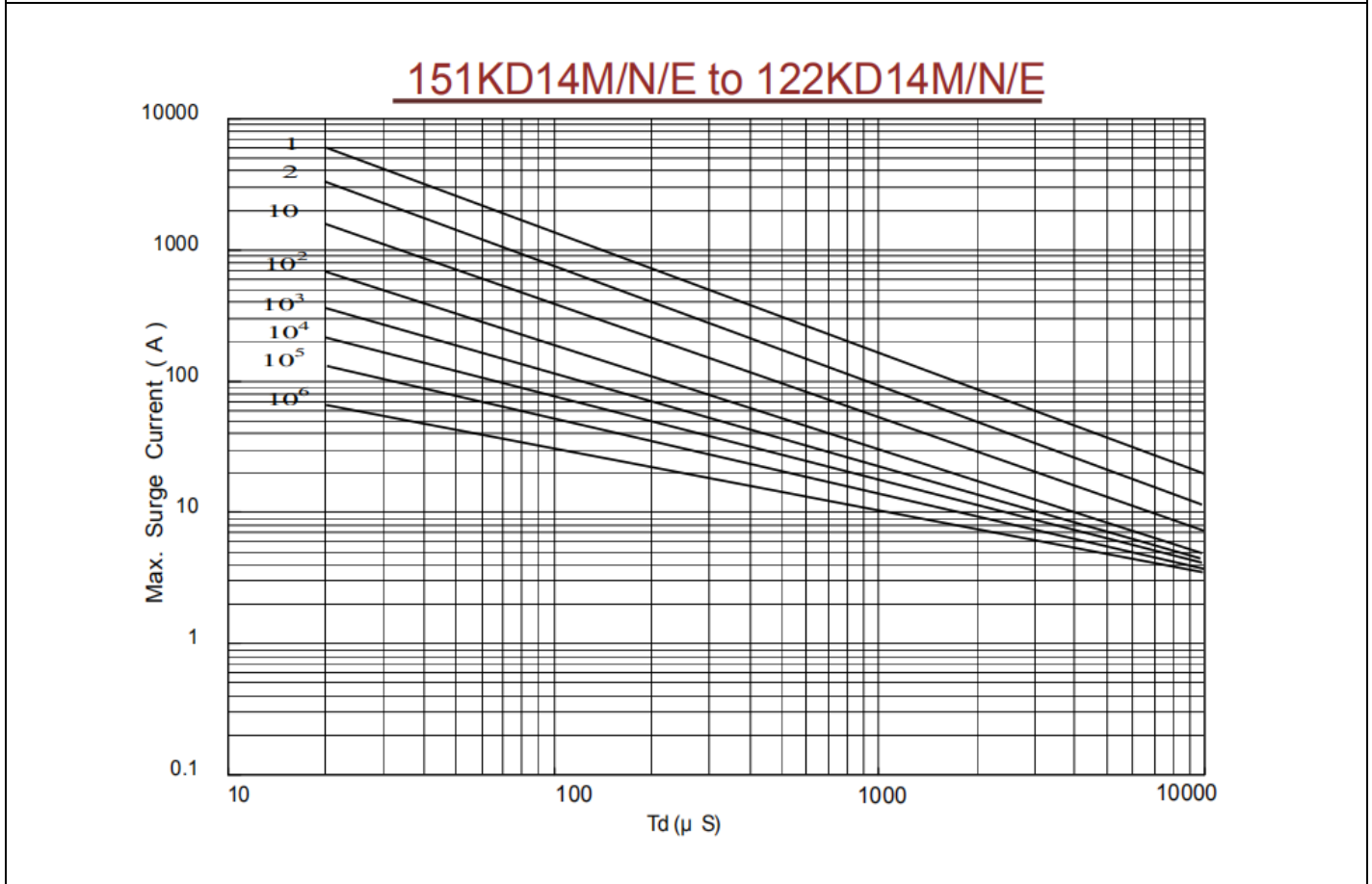
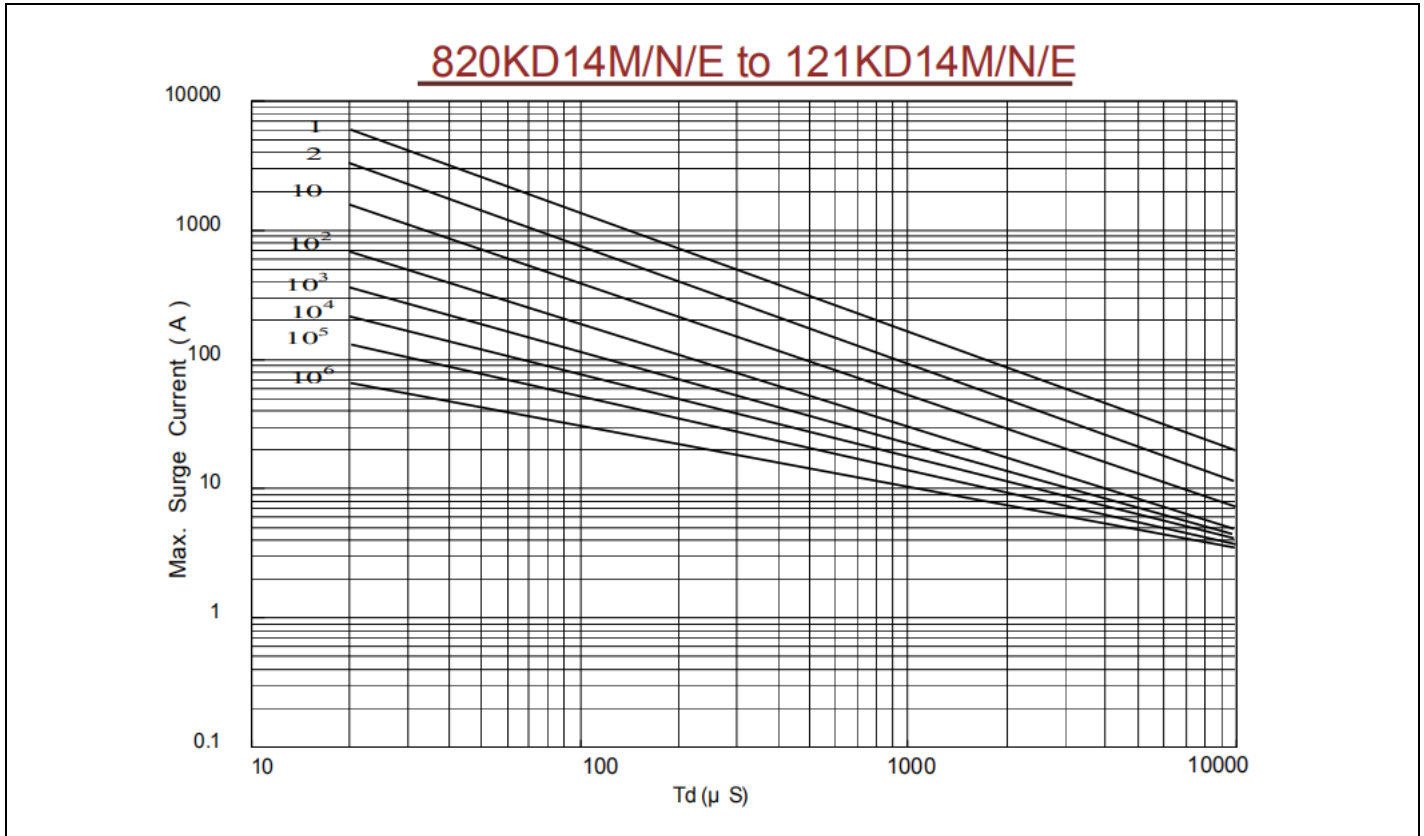

**Soldering Recommendation**

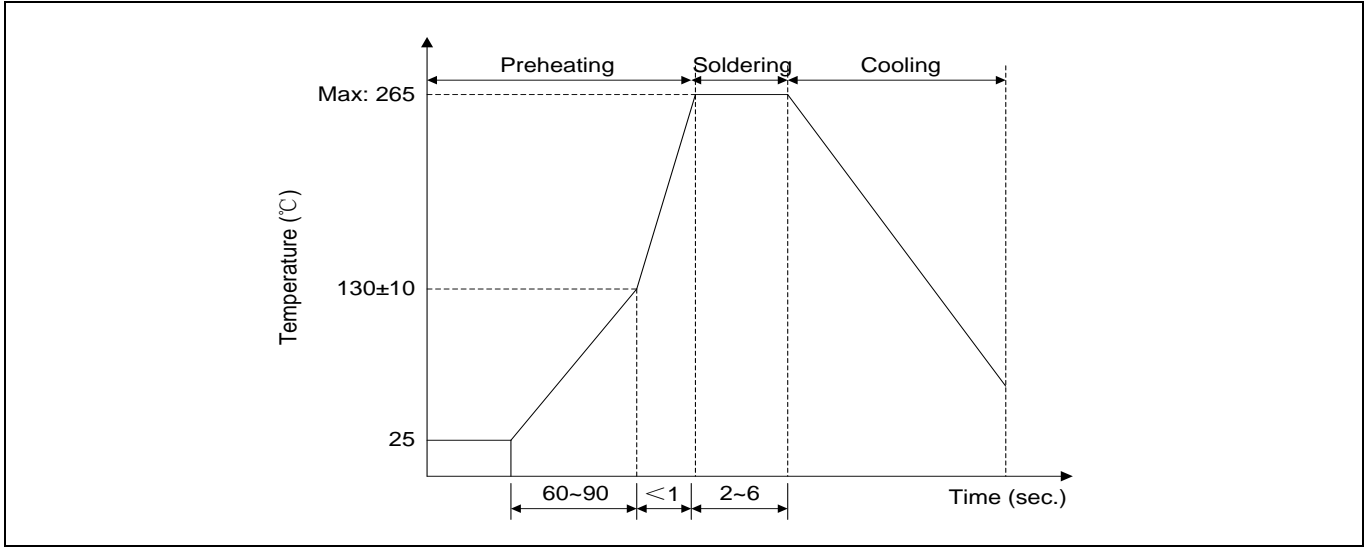

**Marking code**

The diagram shows a circular varistor disk with various markings. Numbered callouts 1 through 7 identify the following features:

- ① Brightking Logo (the 'B' logo)
- ② Varistor Voltage (the 'XXXKXXX' code)
- ③ UL Accreditation Logo (the 'UL' logo)
- ④ Disk Size (the 'XXX' code)
- ⑤ Different internal structure (M / E / N) (the 'Y' code)
- ⑥ Product Line Code ("Y" may be A(a) thru Z(z))
- ⑦ Date Code

**Quantity**

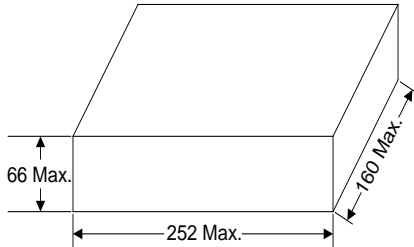
Packaging Dimensions (Unit: mm)	Quantity
<p><b>Bulk</b></p> 	<p>200pcs/bag 2bags/box</p>