

# DATA SHEET

**ELECTROSTATIC DISCHARGE  
PROTECTION DEVICES**

**INDUSTRIAL / CONSUMER**

UAD8A05L01

RoHS compliant & Halogen free



Product specification – March 26, 2021 V.2



## ElectroStatic Discharged Protection Devices (ESD) Data Sheet

### Description

The UAD8A05L01 includes back-to-back TVS diodes fabricated in a proprietary silicon avalanche technology to provide protection for electronic equipment that may experience destructive electrostatic discharge (ESD). These robust diodes can safely absorb repetitive ESD strikes up to the maximum level specified in the IEC61000-4-2 international standard without performance degradation. The back-to-back configuration provides symmetrical ESD protection for data lines when AC signals are present.



Contact : ±8kV  
Air : ±15kV



### Features

- IEC61000-4-2 ESD 15KV Air, 8KV contact compliance
- SOD882 surface mount package
- Working voltage: 5V
- Low leakage current
- Low operating and clamping voltages
- Lead Free/RoHS compliant
- Flammability rating UL 94V-0
- Meets MSL level 1, per J-STD-020
- Marking: U5

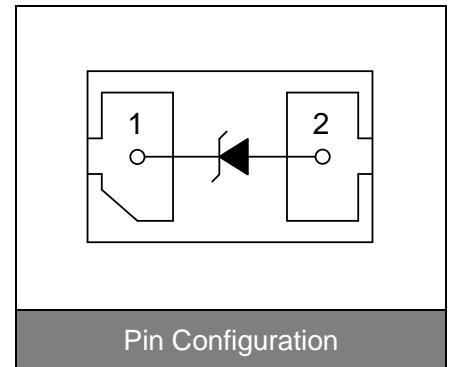

### Applications

- USB 3.0/USB 2.0
- MHL/MIPI/MDDI
- HDMI, Video Port, eSATA
- Set Top Boxes, Game Consoles
- Smart Phones
- External Storage
- Ultrabooks, Notebooks
- Tablets, eReaders

### Maximum Ratings

| Rating                                | Symbol                            | Value    | Unit |
|---------------------------------------|-----------------------------------|----------|------|
| ESD voltage (Contact discharge)       | V <sub>ESD</sub>                  | ±8       | kV   |
| ESD voltage (Air discharge)           |                                   | ±15      |      |
| Storage & operating temperature range | T <sub>STG</sub> , T <sub>J</sub> | -55~+150 | °C   |

**Electrical Characteristics (T<sub>J</sub>=25°C)**

| Parameter                      | Symbol           | Condition            | Min. | Typ. | Max. | Unit |
|--------------------------------|------------------|----------------------|------|------|------|------|
| Reverse stand-off voltage      | V <sub>RWM</sub> |                      |      |      | 5    | V    |
| Reverse breakdown voltage      | V <sub>BR</sub>  | I <sub>BR</sub> =1mA | 6    |      | 8.5  | V    |
| Reverse leakage current        | I <sub>R</sub>   | V <sub>R</sub> =5V   |      |      | 1    | μA   |
| Clamping voltage (tp=8/20μs)   | V <sub>C</sub>   | I <sub>PP</sub> =1A  |      |      | 9.8  | V    |
| Clamping voltage (tp=8/20μs)   | V <sub>C</sub>   | I <sub>PP</sub> =4A  |      |      | 15   | V    |
| Peak pulse current (tp=8/20μs) | I <sub>PP</sub>  |                      |      |      | 5    | A    |
| Clamping voltage TLP (Note1)   | V <sub>C</sub>   | 16A                  |      | 24   |      | V    |
| Off state junction capacitance | C <sub>J</sub>   | 0Vdc,f=1MHz          |      | 0.6  |      | pF   |

Note1. Electrostatic Discharge Sensitivity Testing using Transmission Line Pulse(TLP) Model, See Figure 4.

**Typical Characteristics Curves**

Figure 1. Pulse Waveform

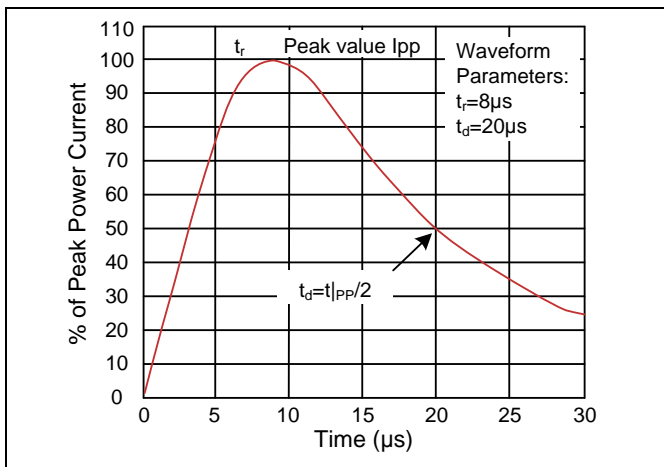

Figure 2. Clamping Voltage vs. Peak Pulse Current

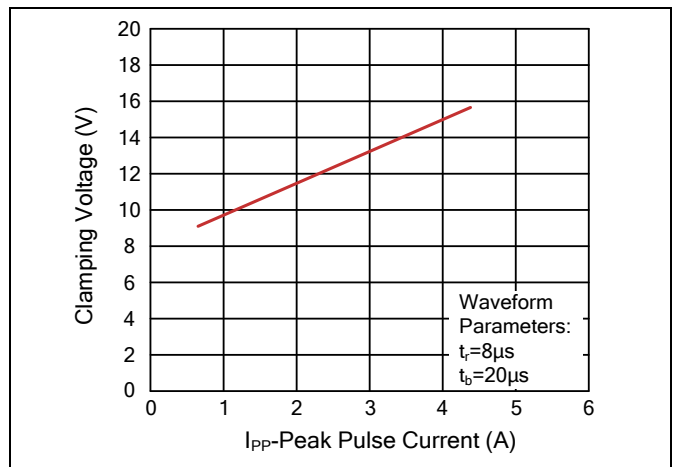

Figure 3. Capacitance vs. Reverse Voltage

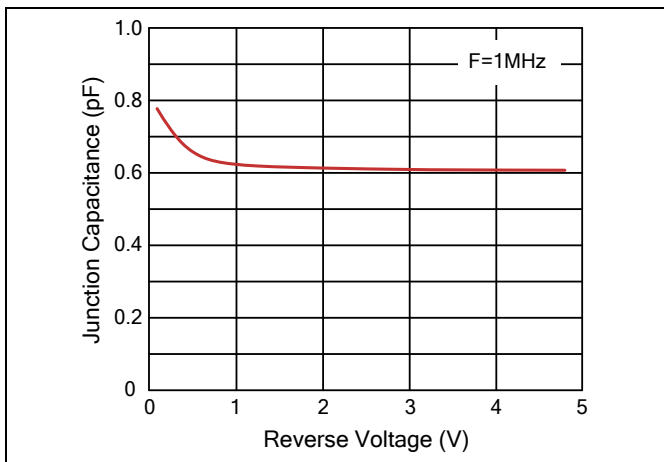
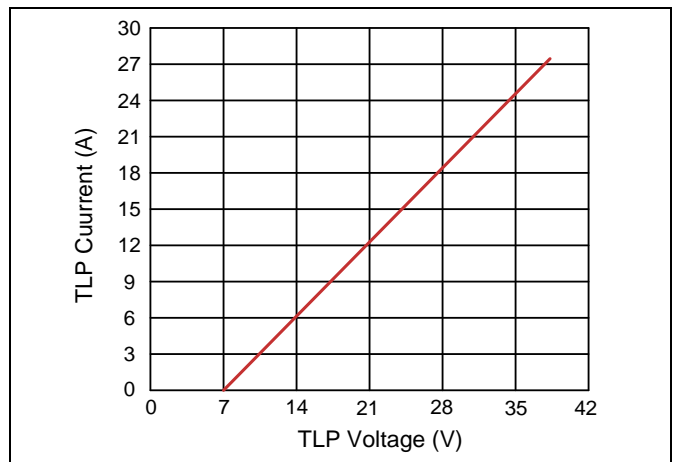
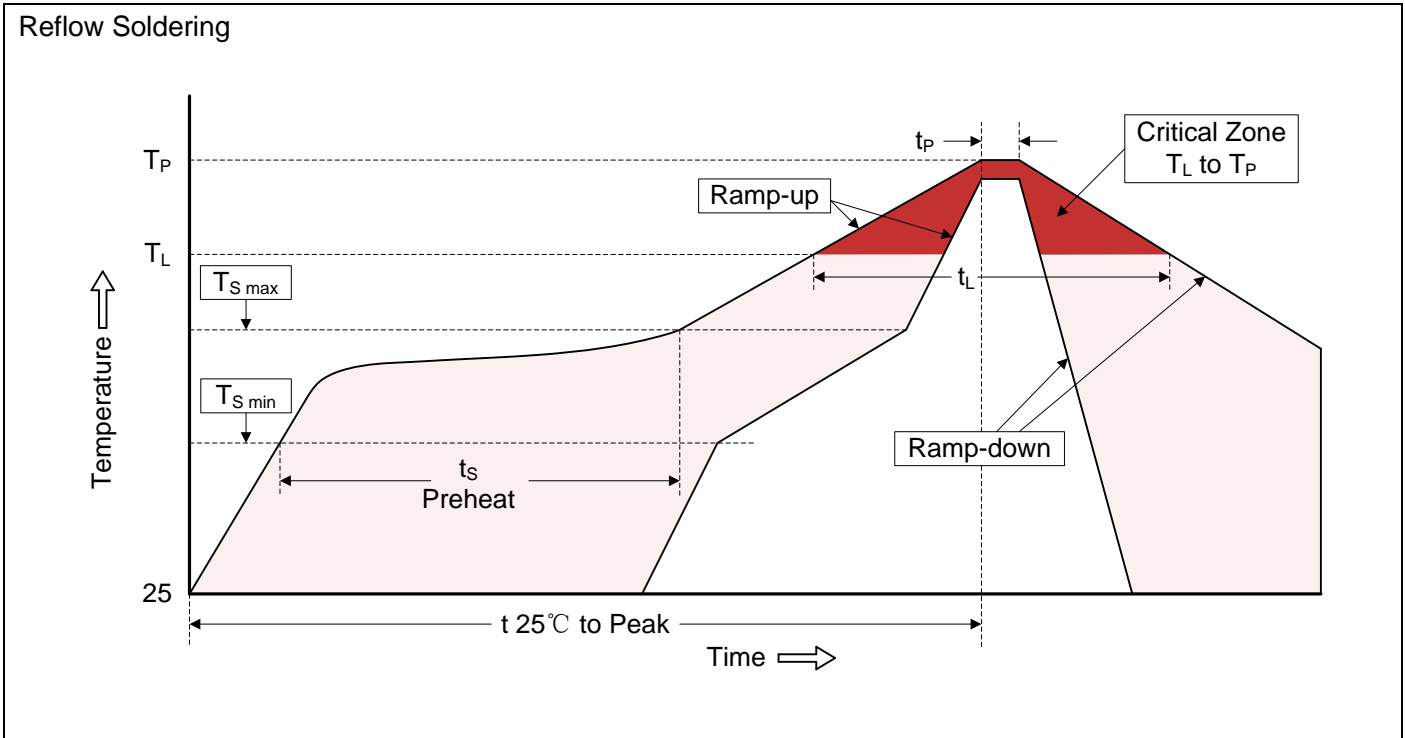

Figure 4. Transmission Line Pulsing (TLP)



### Recommended Soldering Conditions



#### Recommended Conditions

| Profile Feature                                      | Pb-Free Assembly |
|--|------------------|
| Average ramp-up rate ( $T_L$ to $T_P$ )              | 3°C/second max.  |
| Preheat  | 150°C            |
| -Temperature Min ( $T_{S\ min}$ )                    | 200°C            |
| -Temperature Max ( $T_{S\ max}$ )                    | 60-180 seconds   |
| -Time (min to max) ( $t_s$ )                         |                  |
| $T_{S\ max}$ to $T_L$                                | 3°C/second max.  |
| -Ramp-up Rate  |                  |
| Time maintained above:                               | 217°C            |
| -Temperature ( $T_L$ )                               | 60-150 seconds   |
| -Time ( $t_L$ )                                      |                  |
| Peak Temperature ( $T_P$ )                           | 260°C            |
| Time within 5°C of actual Peak Temperature ( $t_P$ ) | 20-40 seconds    |
| Ramp-down Rate                                       | 6°C/second max.  |
| Time 25°C to Peak Temperature                        | 8 minutes max.   |

**Dimensions (SOD882)**

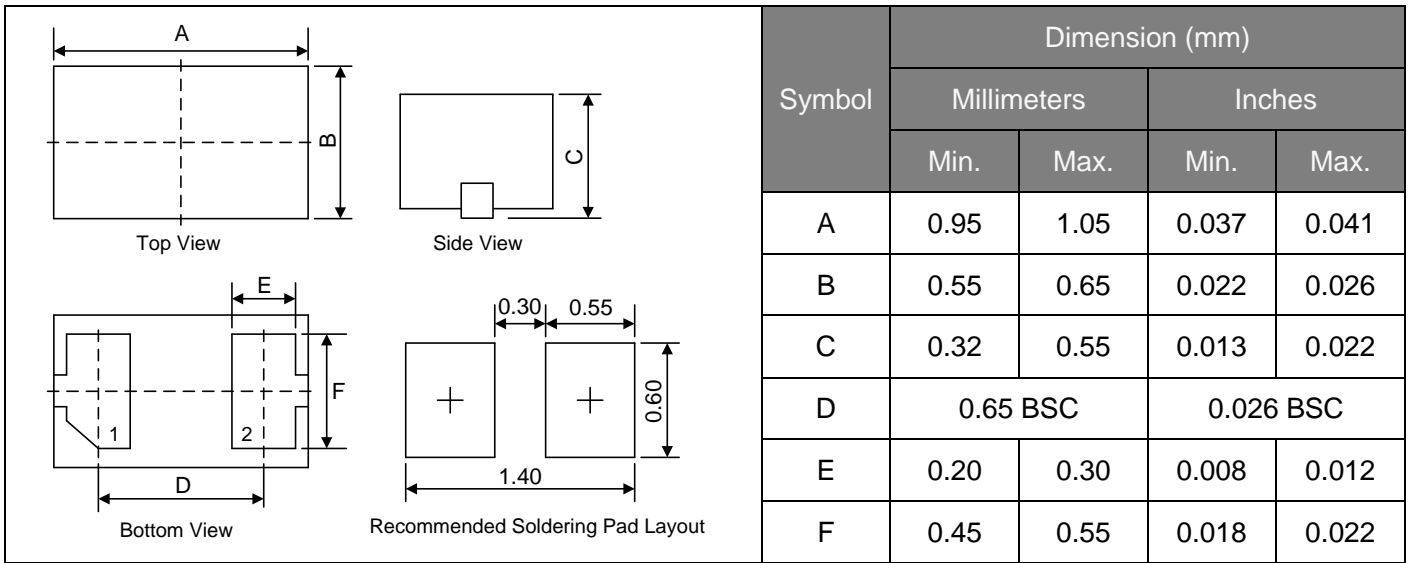

**Packaging**

