

Chip Monolithic Ceramic Capacitors

CHIP
MONOLITHIC
CERAMIC
CAPACITORS

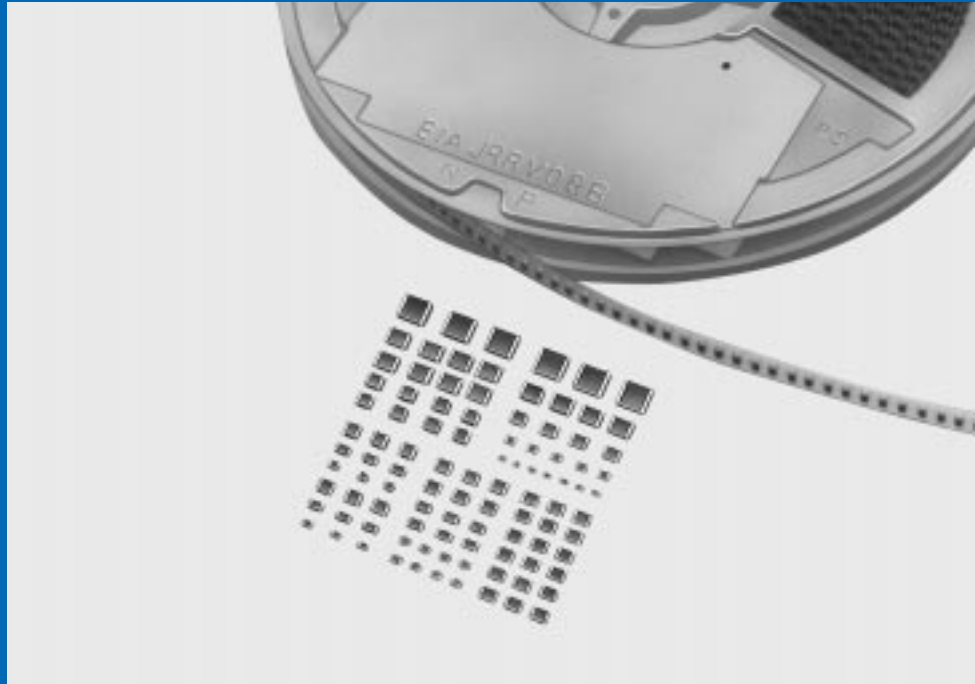

muRata *Innovator
in Electronics*

Murata
Manufacturing Co., Ltd.

Cat.No.C02E-8

CONTENTS

Part Numbering	2
1 for Flow/Reflow Soldering GRP15/GRM15/18/21/31 Series	4
2 for Reflow Soldering GRM32/43/55 Series	14
3 Ultra-small GRP03 Series	15
4 Thin Type(Flow/Reflow)	17
GRP/GRM Series Specifications and Test Methods	18
5 High-power Type	23
GRP/GRM Series Data	28
6 for Smoothing	30
7 Microchip	36
8 Capacitor Array	39
9 for Ultrasonic Sensors	44
10 Low ESL	47
11 High Frequency for Flow/Reflow Soldering	53
12 High-Q & High Power Type	58
13 High Frequency Type	64
ERF/ERH/ERA/ERD Series Data	70
Package	72
Notice	76
Reference Data	85
14 Medium-voltage Low Dissipation Factor	92
15 Medium-voltage High-Capacitance for General-Use	97
16 AC250V(r.m.s.) Type	100
17 Safety Standard Recognized Type	104
GRM/GA2/GA3 Series Data	108
Package	110
⚠ Caution	113
Notice	119
ISO 9000 Certifications	122

● Please refer to "Specifications and Test Methods" at the end of each chapter of **5** - **17** .



● **Part Numbering** (The structure of the "Global Part Numbers" that have been adopted since June 2001 and the meaning of each code are described herein.)
 (If you have any questions about details, inquire at your usual Murata sales office or distributor.)

Chip Monolithic Ceramic Capacitors

(Global Part Number) **GR M 18 8 B1 1H 102 K A01 K**
 ① ② ③ ④ ⑤ ⑥ ⑦ ⑧ ⑨ ⑩

① Product ID

② Series

Product ID	Code	Series
GR	M	Tin Plated layer
	P	Soldering Electrode
ER	F	High-frequency and high-power Type
	H	High-frequency and high-power Type (Ribbon Terminal)
	A	High-frequency Type
	D	High-frequency Type (Ribbon Terminal)
GQ	M	High-frequency for Flow/Reflow Soldering
GM	A	Monolithic Microchip
GN	M	Capacitor Array
LL	L	Low ESL Wide-width Type
GJ	6	Low Dissipation
	2	Smoothing Type
GA	2	for AC250V (r.m.s.)
	3	Safety Standard Recognized Type

③ Dimension (L×W)

Code	Dimension (L×W)	EIA
03	0.6×0.3 mm	0201
05	0.5×0.5 mm	0202
08	0.8×0.8 mm	0303
11	1.25×1.0 mm	0504
15	1.0×0.5 mm	0402
18	1.6×0.8 mm	0603
1X	Depends on individual standards.	
21	2.0×1.25 mm	0805
22	2.8×2.8 mm	1111
31	3.2×1.6 mm	1206
32	3.2×2.5 mm	1210
3X	Depends on individual standards.	
42	4.5×2.0 mm	1808
43	4.5×3.2 mm	1812
52	5.7×2.8 mm	2211
55	5.7×5.0 mm	2220

④ Dimension (T)

Code	Dimension (T)
3	0.3 mm
4	4-elements (Array Type)
5	0.5 mm
6	0.6 mm
7	0.7 mm
8	0.8 mm
9	0.85 mm
A	1.0 mm
B	1.25 mm
C	1.6 mm
D	2.0 mm
E	2.5 mm
M	1.15 mm
N	1.35 mm
R	1.8 mm
Q	1.5 mm
X	Depends on individual standards.

With the array type GNM series, "Dimension(T)" indicates the number of elements.

⑤ Temperature Characteristics

Code	Temperature Characteristics	Temperature Range	Cap. Change or Temp. Coeff.
1X	SL	-55 to 125°C	+350 to -1000ppm/°C
5C	C0G	-55 to 125°C	0±30ppm/°C
6C	C0H	-55 to 125°C	0±60ppm/°C
6P	P2H	-55 to 85°C	-150±60ppm/°C
6R	R2H	-55 to 85°C	-220±60ppm/°C
6T	T2H	-55 to 85°C	-470±60ppm/°C
7U	U2J	-55 to 85°C	-750±120ppm/°C
B3	B	-25 to 85°C	±10%
E4	Z5U	10 to 85°C	+22, -82%
F5	Y5V	-30 to 85°C	+22, -82%
R3	R	-55 to 125°C	±15%
R6	X5R	-55 to 85°C	±15%
R7	X7R	-55 to 125°C	±15%

Continued on the following page. 

Continued from the preceding page.

(Global Part Number) **GR** **M** **18** **8** **B1** **1H** **102** **K** **A01** **K**
 ① ② ③ ④ ⑤ ⑥ ⑦ ⑧ ⑨ ⑩

⑥ Rated Voltage

Code	Rated Voltage
0J	DC6.3V
1A	DC10V
1C	DC16V
1E	DC25V
1H	DC50V
2A	DC100V
2D	DC200V
2E	DC250V
YD	DC300V
2H	DC500V
2J	DC630V
3A	DC1kV
3D	DC2kV
3F	DC3.15kV
E2	AC250V
GB	X2; AC250V (Safety Standard Recognized Type GB)
GC	X1, Y2; AC250V (Safety Standard Recognized Type GC)

⑨ Individual Specification Code

Code	Individual Specification
A**/B**/C**/W**	Base Metal Inner Electrode
Other than above	Precious Metal Inner Electrode

* indicates an alphabet or figure.

⑩ Packaging

Code	Packaging
E	ø178mm 2mm Pitch Paper Taping
F	ø330mm 2mm Pitch Paper Taping
L	ø178mm 4mm Pitch Plastic Taping
D	ø178mm 4mm Pitch Paper Taping
K	ø330mm 4mm Pitch Plastic Taping
J	ø330mm 4mm Pitch Paper Taping
B	Bulk
C	Bulk Case
T	Bulk Tray

⑦ Capacitance

Expressed by three figures. The unit is pico-farad(pF). The first and second figures are significant digits, and the third figure expresses the number of zeros which follow the two numbers. If there is a decimal point, it is expressed by the capital letter "R". In this case, all figures are significant digits.

Ex.)

Code	Capacitance
R50	0.5pF
1R0	1.0pF
100	10pF
103	10000pF

⑧ Capacitance Tolerance

Code	Capacitance Tolerance	TC	Series	Capacitance Step	
B	±0.1pF	CΔ	GJ6,QQM	≤5pF	E24 Series,1pF
C	±0.25pF	CΔ-SL	GRP/GRM/ERF/ERH/ERA/ERD	≤5pF	* 1pF
		CΔ	GJ6,QQM	<10pF	E24 Series,1pF
D	±0.5pF	CΔ-SL	GRP/GRM	6.0 to 9.0pF	* 1pF
		CΔ	ERF/ERH/ERA/ERD	5.1 to 9.1pF	E24 Series
G	±2%	CΔ	GJ6	≥10pF	E12 Series
		CΔ	QQM	≥10pF	E24 Series
J	±5%	CΔ-SL	GRP/GRM	≥10pF	E12 Series
		CΔ	ERF/ERH/ERA/ERD	≥10pF	E24 Series
K	±10%	B,R,X7R,X5R,ZLM	GRP/GRM/GA3	E6 Series	
		B,R,X7R	LLL	E12 Series	
M	±20%	Z5U	GRM	E3 Series	
		B,R,X7R	GMA	E6 Series	
		B	GA2	E3 Series	
Z	+80%, -20%	F,Y5V	GRP/GRM/GJ2	E3 Series	
		F,Y5V,E	LLL	E6 Series	
R		Depends on individual standards.			

* E24 series is also available.

Chip Monolithic Ceramic Capacitors



for Flow/Reflow Soldering GRP15/GRM15/18/21/31 Series

■ Features

1. Terminations are made of metal highly resistant to migration.
2. The GRM series is a complete line of chip ceramic capacitors in 6.3V, 10V, 16V, 25V, 50V and 100V ratings. These capacitors have temperature characteristics ranging from C0G to Y5V.
3. A wide selection of sizes is available, from the miniature LxWxT:1.0x0.5x0.5mm to LxWxT:3.2x1.6x1.15 mm.
GRM18, 21 and GRM31 types are suited to flow and reflow soldering.
GRP15 types is applied to only reflow soldering.
4. Stringent dimensional tolerances allow highly reliable, high speed automatic chip placement on PCBs.
5. The GRP/GRM series is available in paper or plastic embossed tape and reel packaging for automatic placement. Bulk case packaging is also available for GRP15, GRM18, GRM21 electronic equipment.
6. Dielectric layer of GRP15 Y5V 0.22uF/0.47uF/1.0uF are relaxor

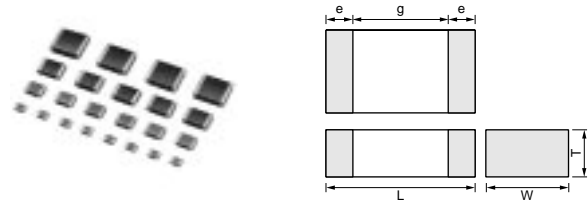

Part Number	Dimensions (mm)				
	L	W	T	e	g min.
GRP155	1.0 ±0.05	0.5 ±0.05	0.5 ±0.05	0.15 to 0.3	0.4
GRM155			0.6 ±0.1		
GRM188*	1.6 ±0.1	0.8 ±0.1	0.8 ±0.1	0.2 to 0.5	0.5
GRM216	2.0 ±0.1	1.25 ±0.1	0.6 ±0.1	0.2 to 0.7	0.7
GRM219			0.85 ±0.1		
GRM21B			1.25 ±0.1		
GRM319	3.2 ±0.15	1.6 ±0.15	0.85 ±0.1	0.3 to 0.8	1.5
GRM31M			1.15 ±0.1		
GRM31C	3.2 ±0.2	1.6 ±0.2	1.6 ±0.2		

* Bulk Case : 1.6 ±0.07(L) × 0.8 ±0.07(W) × 0.8 ±0.07(T)

■ Applications

General electronic equipment.

Temperature Compensating Type GRP15/GRM15 Series (1.0x0.5mm)

Part Number	GRP15/GRM15								
L x W [EIA]	1.00x0.50 [0402]								
TC	C0G (5C)	C0H (6C)	P2H (6P)	R2H (6R)	S2H (6S)	SL (1X)		T2H (6T)	U2J (7U)
Rated Volt.	50 (1H)	25 (1E)	50 (1H)	50 (1H)	50 (1H)	25 (1E)	50 (1H)	50 (1H)	50 (1H)
Capacitance and T Dimension									
0.5pF(R50)	0.50(5)								
0.75pF(R75)	0.50(5)								
1.0pF(1R0)	0.50(5)								
2.0pF(2R0)	0.50(5)								
3.0pF(3R0)	0.50(5)		0.50(5)	0.50(5)	0.50(5)			0.50(5)	0.50(5)
4.0pF(4R0)	0.50(5)		0.50(5)	0.50(5)	0.50(5)			0.50(5)	0.50(5)
5.0pF(5R0)	0.50(5)		0.50(5)	0.50(5)	0.50(5)			0.50(5)	0.50(5)
6.0pF(6R0)	0.50(5)		0.50(5)	0.50(5)	0.50(5)			0.50(5)	0.50(5)
7.0pF(7R0)	0.50(5)		0.50(5)	0.50(5)	0.50(5)			0.50(5)	0.50(5)
8.0pF(8R0)	0.50(5)		0.50(5)	0.50(5)	0.50(5)			0.50(5)	0.50(5)
9.0pF(9R0)	0.50(5)		0.50(5)	0.50(5)	0.50(5)			0.50(5)	0.50(5)
10.0pF(100)	0.50(5)		0.50(5)	0.50(5)	0.50(5)			0.50(5)	0.50(5)
12.0pF(120)	0.50(5)		0.50(5)	0.50(5)	0.50(5)			0.50(5)	0.50(5)
15.0pF(150)	0.50(5)		0.50(5)	0.50(5)	0.50(5)			0.50(5)	0.50(5)
18.0pF(180)	0.50(5)		0.50(5)	0.50(5)	0.50(5)			0.50(5)	0.50(5)
22.0pF(220)	0.50(5)		0.50(5)	0.50(5)	0.50(5)			0.50(5)	0.50(5)
27.0pF(270)	0.50(5)		0.50(5)	0.50(5)	0.50(5)			0.50(5)	0.50(5)

Continued on the following page.

 Continued from the preceding page.

Part Number	GRP15/GRM15								
L x W [EIA]	1.00x0.50 [0402]								
TC	COG (5C)	COH (6C)	P2H (6P)	R2H (6R)	S2H (6S)	SL (1X)		T2H (6T)	U2J (7U)
Rated Volt.	50 (1H)	25 (1E)	50 (1H)	50 (1H)	50 (1H)	25 (1E)	50 (1H)	50 (1H)	50 (1H)
Capacitance and T Dimension									
33.0pF(330)	0.50(5)			0.50(5)	0.50(5)			0.50(5)	0.50(5)
39.0pF(390)	0.50(5)				0.50(5)			0.50(5)	0.50(5)
47pF(470)	0.50(5)						0.50(5)	0.50(5)	0.50(5)
56pF(560)	0.50(5)						0.50(5)	0.50(5)	0.50(5)
68pF(680)	0.50(5)						0.50(5)	0.50(5)	0.50(5)
82pF(820)	0.50(5)						0.50(5)	0.50(5)	0.50(5)
100pF(101)	0.50(5)						0.50(5)	0.50(5)	0.50(5)
120pF(121)	0.50(5)						0.50(5)		0.50(5)
150pF(151)	0.50(5)						0.50(5)		0.50(5)
180pF(181)		0.50(5)					0.50(5)		0.50(5)
220pF(221)		0.50(5)				0.50(5)			
270pF(271)		0.50(5)				0.50(5)			
330pF(331)						0.50(5)			
390pF(391)						0.50(5)			

The part numbering code is shown in ().
Dimensions are shown in mm and Rated Voltage in Vdc.

Temperature Compensating Type GRM18 Series (1.60x0.80mm)

Part Number	GRM18												
L x W [EIA]	1.60x0.80 [0603]												
TC	COG (5C)		COH (6C)	P2H (6P)	R2H (6R)	S2H (6S)	SL (1X)				T2H (6T)	U2J (7U)	
Rated Volt.	50 (1H)	100 (2A)	200 (2D)	25 (1E)	50 (1H)	50 (1H)	50 (1H)	25 (1E)	50 (1H)	100 (2A)	200 (2D)	50 (1H)	50 (1H)
Capacitance and T Dimension													
0.5pF(R50)	0.80(8)		0.80(8)										
0.75pF(R75)	0.80(8)		0.80(8)										
1.0pF(1R0)	0.80(8)		0.80(8)										
2.0pF(2R0)	0.80(8)		0.80(8)										
3.0pF(3R0)	0.80(8)		0.80(8)		0.80(8)	0.80(8)	0.80(8)					0.80(8)	0.80(8)
4.0pF(4R0)	0.80(8)		0.80(8)		0.80(8)	0.80(8)	0.80(8)					0.80(8)	0.80(8)
5.0pF(5R0)	0.80(8)		0.80(8)		0.80(8)	0.80(8)	0.80(8)					0.80(8)	0.80(8)
6.0pF(6R0)	0.80(8)		0.80(8)		0.80(8)	0.80(8)	0.80(8)					0.80(8)	0.80(8)
7.0pF(7R0)	0.80(8)		0.80(8)		0.80(8)	0.80(8)	0.80(8)					0.80(8)	0.80(8)
8.0pF(8R0)	0.80(8)		0.80(8)		0.80(8)	0.80(8)	0.80(8)					0.80(8)	0.80(8)
9.0pF(9R0)	0.80(8)		0.80(8)		0.80(8)	0.80(8)	0.80(8)					0.80(8)	0.80(8)
10.0pF(100)	0.80(8)		0.80(8)		0.80(8)	0.80(8)	0.80(8)					0.80(8)	0.80(8)
12pF(120)	0.80(8)	0.80(8)			0.80(8)	0.80(8)	0.80(8)				0.80(8)	0.80(8)	0.80(8)
15pF(150)	0.80(8)	0.80(8)			0.80(8)	0.80(8)	0.80(8)				0.80(8)	0.80(8)	0.80(8)
18pF(180)	0.80(8)	0.80(8)			0.80(8)	0.80(8)	0.80(8)				0.80(8)	0.80(8)	0.80(8)
22pF(220)	0.80(8)	0.80(8)			0.80(8)	0.80(8)	0.80(8)				0.80(8)	0.80(8)	0.80(8)
27pF(270)	0.80(8)	0.80(8)			0.80(8)	0.80(8)	0.80(8)				0.80(8)	0.80(8)	0.80(8)
33pF(330)	0.80(8)	0.80(8)			0.80(8)	0.80(8)	0.80(8)				0.80(8)	0.80(8)	0.80(8)
39pF(390)	0.80(8)	0.80(8)			0.80(8)	0.80(8)	0.80(8)				0.80(8)	0.80(8)	0.80(8)
47pF(470)	0.80(8)	0.80(8)			0.80(8)	0.80(8)	0.80(8)				0.80(8)	0.80(8)	0.80(8)
56pF(560)	0.80(8)	0.80(8)			0.80(8)	0.80(8)	0.80(8)				0.80(8)	0.80(8)	0.80(8)
68pF(680)	0.80(8)	0.80(8)			0.80(8)	0.80(8)	0.80(8)		0.80(8)		0.80(8)	0.80(8)	0.80(8)
82pF(820)	0.80(8)	0.80(8)			0.80(8)	0.80(8)	0.80(8)		0.80(8)		0.80(8)	0.80(8)	0.80(8)
100pF(101)	0.80(8)	0.80(8)			0.80(8)	0.80(8)	0.80(8)		0.80(8)		0.80(8)	0.80(8)	0.80(8)
120pF(121)	0.80(8)	0.80(8)			0.80(8)	0.80(8)	0.80(8)		0.80(8)	0.80(8)		0.80(8)	0.80(8)

Continued on the following page. 

 Continued from the preceding page.

1

Part Number	GRM18												
L x W [EIA]	1.60x0.80 [0603]												
TC	COG (5C)			COH (6C)	P2H (6P)	R2H (6R)	S2H (6S)	SL (1X)				T2H (6T)	U2J (7U)
Rated Volt.	50 (1H)	100 (2A)	200 (2D)	25 (1E)	50 (1H)	50 (1H)	50 (1H)	25 (1E)	50 (1H)	100 (2A)	200 (2D)	50 (1H)	50 (1H)
Capacitance and T Dimension													
150pF(151)	0.80(8)	0.80(8)			0.80(8)	0.80(8)	0.80(8)		0.80(8)	0.80(8)		0.80(8)	0.80(8)
180pF(181)	0.80(8)					0.80(8)	0.80(8)		0.80(8)	0.80(8)		0.80(8)	0.80(8)
220pF(221)	0.80(8)						0.80(8)		0.80(8)	0.80(8)		0.80(8)	0.80(8)
270pF(271)	0.80(8)								0.80(8)	0.80(8)		0.80(8)	0.80(8)
330pF(331)	0.80(8)								0.80(8)	0.80(8)		0.80(8)	0.80(8)
390pF(391)	0.80(8)								0.80(8)	0.80(8)		0.80(8)	0.80(8)
470pF(471)	0.80(8)								0.80(8)				0.80(8)
560pF(561)	0.80(8)			0.80(8)					0.80(8)				0.80(8)
680pF(681)	0.80(8)								0.80(8)				0.80(8)
820pF(821)	0.80(8)							0.80(8)					
1000pF(102)	0.80(8)							0.80(8)					
1200pF(122)								0.80(8)					
1500pF(152)								0.80(8)					

The part numbering code is shown in ().
Dimensions are shown in mm and Rated Voltage in Vdc.

Temperature Compensating Type GRM21 Series (2.00x1.25mm)

Part Number	GRM21												
L x W [EIA]	2.00x1.25 [0805]												
TC	COG (5C)			COH (6C)	P2H (6P)	R2H (6R)	S2H (6S)	SL (1X)				T2H (6T)	U2J (7U)
Rated Volt.	50 (1H)	100 (2A)	200 (2D)	25 (1E)	50 (1H)	50 (1H)	50 (1H)	25 (1E)	50 (1H)	100 (2A)	200 (2D)	50 (1H)	50 (1H)
Capacitance and T Dimension													
12pF(120)			0.85(9)										
15pF(150)			0.85(9)										
18pF(180)			0.85(9)										
22pF(220)			0.85(9)										
27pF(270)			0.85(9)										
33pF(330)			0.85(9)										
39pF(390)			0.85(9)										
47pF(470)			0.85(9)										
56pF(560)			0.85(9)										
68pF(680)		0.85(9)	1.25(B)										
82pF(820)		0.85(9)	1.25(B)										
100pF(101)		0.85(9)	1.25(B)										
120pF(121)		0.85(9)	1.25(B)								0.85(9)		
150pF(151)		0.85(9)	1.25(B)								1.25(B)		
180pF(181)		0.85(9)	1.25(B)		0.85(9)						1.25(B)		
220pF(221)		0.85(9)	1.25(B)		0.85(9)	0.85(9)					1.25(B)		
270pF(271)		0.85(9)			0.85(9)	0.85(9)	0.85(9)				1.25(B)		
330pF(331)		0.85(9)			0.85(9)	0.85(9)	0.85(9)				1.25(B)		
390pF(391)		1.25(B)			1.25(B)	0.85(9)	0.85(9)				1.25(B)		
470pF(471)		1.25(B)			1.25(B)	0.85(9)	0.85(9)			0.85(9)	1.25(B)		
560pF(561)	0.60(6)	1.25(B)			1.25(B)	1.25(B)	1.25(B)			0.85(9)		1.25(B)	
680pF(681)	0.85(9)	1.25(B)				1.25(B)	1.25(B)			0.85(9)		1.25(B)	
820pF(821)	0.85(9)	1.25(B)					1.25(B)		0.60(6)	1.25(B)		1.25(B)	0.60(6)
1000pF(102)	0.85(9)	1.25(B)							0.60(6)	1.25(B)		1.25(B)	0.60(6)
1200pF(122)	0.85(9)								0.60(6)	1.25(B)		1.25(B)	0.60(6)
1500pF(152)	0.85(9)								0.85(9)	1.25(B)		1.25(B)	0.85(9)

Continued on the following page. 

Continued from the preceding page.

Part Number	GRM21												
L x W [EIA]	2.00x1.25 [0805]												
TC	COG (5C)			COH (6C)	P2H (6P)	R2H (6R)	S2H (6S)	SL (1X)				T2H (6T)	U2J (7U)
Rated Volt.	50 (1H)	100 (2A)	200 (2D)	25 (1E)	50 (1H)	50 (1H)	50 (1H)	25 (1E)	50 (1H)	100 (2A)	200 (2D)	50 (1H)	50 (1H)
Capacitance and T Dimension													
1800pF(182)	1.25(B)								0.85(9)	1.25(B)		1.25(B)	0.85(9)
2200pF(222)	1.25(B)								0.85(9)				0.85(9)
2700pF(272)				1.25(B)					1.25(B)				1.25(B)
3300pF(332)				1.25(B)					1.25(B)				1.25(B)
3900pF(392)				1.25(B)				0.85(9)					
4700pF(472)								0.85(9)					
5600pF(562)								1.25(B)					
6800pF(682)								1.25(B)					

The part numbering code is shown in ().
Dimensions are shown in mm and Rated Voltage in Vdc.

Temperature Compensating Type GRM31 Series (3.20x1.60mm)

Part Number	GRM31														
L x W [EIA]	3.20x1.60 [1206]														
TC	COG (5C)				COH (6C)	P2H (6P)	R2H (6R)	S2H (6S)	SL (1X)					T2H (6T)	U2J (7U)
Rated Volt.	25 (1E)	50 (1H)	200 (2D)	500 (2H)	25 (1E)	50 (1H)	50 (1H)	50 (1H)	25 (1E)	50 (1H)	100 (2A)	200 (2D)	500 (2H)	50 (1H)	50 (1H)
Capacitance and T Dimension															
1.0pF(1R0)				1.15(M)											
2.0pF(2R0)				1.15(M)											
3.0pF(3R0)				1.15(M)											
4.0pF(4R0)				1.15(M)											
5.0pF(5R0)				1.15(M)											
6.0pF(6R0)				1.15(M)											
7.0pF(7R0)				1.15(M)											
8.0pF(8R0)				1.15(M)											
9.0pF(9R0)				1.15(M)											
10.0pF(100)				1.15(M)											
12pF(120)				1.15(M)											
15pF(150)				1.15(M)											
18pF(180)				1.15(M)											
22pF(220)				1.15(M)											
27pF(270)				1.15(M)											
33pF(330)				1.15(M)											
39pF(390)				1.15(M)											
47pF(470)				1.15(M)											
56pF(560)				1.15(M)											
68pF(680)				1.15(M)											
82pF(820)				1.15(M)											
100pF(101)				1.15(M)											
120pF(121)				1.15(M)											
150pF(151)													1.15(M)		
180pF(181)													1.15(M)		
220pF(221)													1.15(M)		
270pF(271)			1.15(M)										1.15(M)		
330pF(331)			1.15(M)												
390pF(391)			1.15(M)												
470pF(471)			1.15(M)												
560pF(561)												1.15(M)			

Continued on the following page.

 Continued from the preceding page.

1

Part Number	GRM31														
L x W [EIA]	3.20x1.60 [1206]														
TC	COG (5C)				COH (6C)	P2H (6P)	R2H (6R)	S2H (6S)	SL (1X)					T2H (6T)	U2J (7U)
Rated Volt.	25 (1E)	50 (1H)	200 (2D)	500 (2H)	25 (1E)	50 (1H)	50 (1H)	50 (1H)	25 (1E)	50 (1H)	100 (2A)	200 (2D)	500 (2H)	50 (1H)	50 (1H)
Capacitance and T Dimension															
680pF(681)						0.85(9)							1.15(M)		
820pF(821)						0.85(9)	0.85(9)						1.15(M)		
1000pF(102)						1.15(M)	1.15(M)	0.85(9)					1.15(M)		
1200pF(122)						1.15(M)	1.15(M)	1.15(M)					1.15(M)		
1500pF(152)						1.15(M)	1.15(M)	1.15(M)							
1800pF(182)								1.15(M)							
2200pF(222)											1.15(M)			1.15(M)	
2700pF(272)		0.85(9)									1.15(M)			1.15(M)	
3300pF(332)		0.85(9)									1.15(M)			1.15(M)	
3900pF(392)		1.15(M)								0.85(9)	1.15(M)			1.15(M)	0.85(9)
4700pF(472)		0.85(9)								0.85(9)	1.15(M)				0.85(9)
5600pF(562)		1.15(M)								0.85(9)					0.85(9)
6800pF(682)					0.85(9)					1.15(M)					1.15(M)
8200pF(822)					1.15(M)					1.15(M)					1.15(M)
10000pF(103)	0.85(9)									1.15(M)					
12000pF(123)										1.15(M)					
15000pF(153)										1.15(M)					

The part numbering code is shown in ().
Dimensions are shown in mm and Rated Voltage in Vdc.

High Dielectric Constant Type X5R(R6) Characteristics

TC	X5R (R6)																	
Part Number	GRP15			GRM18			GRM21			GRM31								
L x W [EIA]	1.00x0.50 [0402]			1.60x0.80 [0603]			2.00x1.25 [0805]			3.20x1.60 [1206]								
Rated Volt.	10 (1A)			6.3 (0J)			6.3 (0J)			10 (1A)			6.3 (0J)			10 (1A)		
Capacitance and T Dimension																		
68000pF(683)	0.50(5)																	
0.1μF(104)	0.50(5)																	
0.47μF(474)				0.80(8)														
1.0μF(105)				0.80(8)						0.85(9)								
1.5μF(155)							0.85(9)											
2.2μF(225)							1.25(B)									0.85(9)		
3.3μF(335)							1.25(B)									1.30(X)		
4.7μF(475)							1.25(B)						1.15(M)			1.60(C)		
10μF(106)													1.60(C)					

The part numbering code is shown in each ().
3.3μF and 4.7μF for 6.3V is replaced with GRM21B series of L:2±0.15, W:1.25±0.15, T:1.25±0.15.
T:1.25±0.1mm is also available for GRM21 10V 1.0μF type.
3.3μF for 10V rated is replaced with GRM31X series of L:3.2±0.2, W:1.6±0.2, T:1.2±0.1mm.
T:1.15±0.1 is also available for GRM31, 16V, 1.0μF type.
Dimensions are shown in mm and Rated Voltage in Vdc.

High Dielectric Constant Type X7R(R7) Characteristics

TC	X7R (R7)															
Part Number	GRP15				GRM18					GRM21			GRM31			
L x W [EIA]	1.00x0.50 [0402]				1.60x0.80 [0603]					2.00x1.25 [0805]			3.20x1.60 [1206]			
Rated Volt.	10 (1A)	16 (1C)	25 (1E)	50 (1H)	10 (1A)	16 (1C)	25 (1E)	50 (1H)	100 (2A)	16 (1C)	25 (1E)	50 (1H)	10 (1A)	16 (1C)	25 (1E)	50 (1H)
Capacitance and T Dimension																
220pF (221)				0.50 (5)				0.80 (8)								
330pF (331)				0.50 (5)				0.80 (8)								
470pF (471)				0.50 (5)				0.80 (8)								
680pF (681)				0.50 (5)				0.80 (8)								
1000pF (102)				0.50 (5)				0.80 (8)								
1500pF (152)				0.50 (5)				0.80 (8)								
2200pF (222)				0.50 (5)				0.80 (8)	0.80 (8)							
3300pF (332)				0.50 (5)				0.80 (8)	0.80 (8)							
4700pF (472)				0.50 (5)				0.80 (8)								
6800pF (682)			0.50 (5)					0.80 (8)								
10000pF (103)			0.50 (5)					0.80 (8)								
15000pF (153)		0.50 (5)						0.80 (8)								
22000pF (223)		0.50 (5)						0.80 (8)								
33000pF (333)	0.50 (5)							0.80 (8)					0.85 (9)			
47000pF (473)	0.50 (5)							0.80 (8)					1.25 (B)			
68000pF (683)								0.80 (8)					1.25 (B)			
0.10μF (104)						0.80 (8)	0.80 (8)					1.25 (B)	1.25 (B)			
0.15μF (154)					0.80 (8)							1.25 (B)	1.25 (B)			
0.22μF (224)					0.80 (8)							0.85 (B)	1.25 (B)			
0.33μF (334)												1.25 (B)				0.85 (9)
0.47μF (474)										0.85 (9)	1.25 (B)					1.15 (M)
0.68μF (684)										0.85 (9)					0.85 (9)	
1.00μF (105)										1.25 (B)			0.85 (9)	0.85 (9)	1.15 (M)	
1.5μF (155)														1.15 (M)		

Continued on the following page.

 Continued from the preceding page.

1

TC	X7R (R7)																	
Part Number	GRP15				GRM18					GRM21				GRM31				
L x W [EIA]	1.00x0.50 [0402]				1.60x0.80 [0603]					2.00x1.25 [0805]				3.20x1.60 [1206]				
Rated Volt.	10 (1A)	16 (1C)	25 (1E)	50 (1H)	10 (1A)	16 (1C)	25 (1E)	50 (1H)	100 (2A)	16 (1C)	25 (1E)	50 (1H)	10 (1A)	16 (1C)	25 (1E)	50 (1H)		
Capacitance and T Dimension																		
2.2μF (225)															1.15 (M)	1.15 (M)		

The part numbering code is shown in each ().

0.10μF, 50V rated are GRM21 series of L:2±0.15, W:1.25±0.15, T:1.25±0.15.

T:1.25±0.1mm is also available for GRM31 1.0μF for 16V.

The tolerance will be changed to L:3.2±0.2,W:1.6±0.2 for GRM31 16V 1.0μF type. Also L:3.2±0.2, W:1.6±0.2, T:1.15±0.15 for GRM31 16V 1.5μF and 2.2μF type.

Dimensions are shown in mm and Rated Voltage in Vdc.

High Dielectric Constant Type Y5V(F5) Characteristics

TC	Y5V (F5)																		
Part Number	GRP15					GRM18					GRM21				GRM31				
L x W [EIA]	1.00x0.50 [0402]					1.60x0.80 [0603]					2.00x1.25 [0805]				3.20x1.60 [1206]				
Rated Volt.	6.3 (0J)	10 (1A)	16 (1C)	25 (1E)	50 (1H)	10 (1A)	16 (1C)	25 (1E)	50 (1H)	100 (2A)	10 (1A)	16 (1C)	25 (1E)	50 (1H)	6.3 (0J)	10 (1A)	16 (1C)	25 (1E)	50 (1H)
Capacitance and T Dimension																			
2200pF (222)					0.50 (5)														
4700pF (472)					0.50 (5)					0.80 (8)									
10000pF (103)					0.50 (5)				0.80 (8)										
22000pF (223)				0.50 (5)					0.80 (8)										
47000pF (473)			0.50 (5)						0.80 (8)										
0.10μF (104)			0.50 (5)						0.80 (8)					0.85 (9)					
0.22μF (224)		0.50 (5)							0.80 (8)				0.85 (9)	1.25 (B)					
0.47μF (474)		0.50 (5)				0.80 (8)	0.80 (8)						1.25 (B)						1.15 (M)
1.0μF (105)	0.50 (5)					0.80 (8)					0.85 (9)	0.85 (9)	0.85 (9)				0.85 (9)	1.15 (M)	
2.2μF (225)											1.25 (B)	1.25 (B)	1.25 (B)			0.85 (9)	1.15 (M)		
4.7μF (475)											1.25 (B)					1.15 (M)	1.15 (M)		
10.0μF (106)															1.15 (M)	1.15 (M)			

The part numbering code is shown in each ().

T:1.25±0.1mm is also available for GRM21 25V or 16V 1.0μF type.

Dimensions are shown in mm and Rated Voltage in Vdc.

High Dielectric Constant Type Z5U(E4) Characteristics

TC	Z5U (E4)		
Part Number	GRM18	GRM21	GRM31
L x W [EIA]	1.60x0.80 [0603]	2.00x1.25 [0805]	3.20x1.60 [1206]
Rated Volt.	50 (1H)	50 (1H)	50 (1H)
Capacitance and T Dimension			
10000pF(103)	0.80(8)		
22000pF(223)	0.80(8)		
47000pF(473)		0.60(6)	
0.10μF(104)		0.85(9)	
0.22μF(224)			0.85(9)

The part numbering code is shown in ().
 Dimensions are shown in mm and Rated Voltage in Vdc.

Chip Monolithic Ceramic Capacitors



for Reflow Soldering GRM32/43/55 Series

2

■ Features

1. Terminations are made of metal highly resistant to migration.
2. The GRM series is a complete line of chip ceramic capacitors in 10V, 16V, 25V, 50V and 100V ratings. These capacitors have temperature characteristics ranging from C0G to Y5V.
3. This series consists of type LxWxT:3.2x2.5x0.85mm to LxWxT:5.7x5.9x2.0mm. These are suited to only reflow soldering.
4. Stringent dimensional tolerances allow highly reliable, high speed automatic chip placement on PCBs.
5. The GRM series is available in paper or plastic embossed tape and reel packaging for automatic placement.

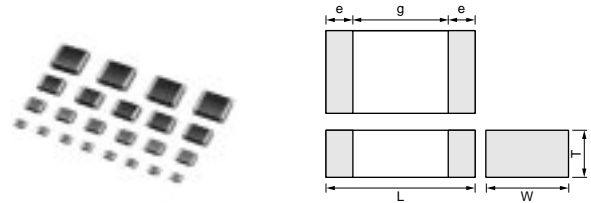

Part Number	Dimensions (mm)				
	L	W	T	e min.	g min.
GRM329	3.2 ±0.3	2.5 ±0.2	0.85 ±0.1	0.3	1.0
GRM32M			1.15 ±0.1		
GRM32N			1.35 ±0.15		
GRM32R			1.8 ±0.2		
GRM32E			2.5 ±0.2		
GRM43M	4.5 ±0.4	3.2 ±0.3	1.15 ±0.1	0.3	2.0
GRM43N			1.35 ±0.15		
GRM43R			1.8 ±0.2		
GRM55N			1.35 ±0.15		
GRM55R	5.7 ±0.4	5.0 ±0.4	1.8 ±0.2	0.3	2.0

■ Applications

General electronic equipment.

Temperature Compensating Type GRM32 Series (3.20x2.50mm)

Part Number	GRM32					
L x W [EIA]	3.20x2.50 [1210]					
TC	C0G (5C)			SL (1X)		
Rated Volt.	200 (2D)	500 (2H)	50 (1H)	100 (2A)	200 (2D)	500 (2H)
Capacitance and T Dimension						
150pF(151)		1.35(N)				
180pF(181)		1.35(N)				
330pF(331)						1.15(M)
390pF(391)						1.15(M)
470pF(471)						1.35(N)
560pF(561)	1.35(N)					
680pF(681)	1.35(N)					
820pF(821)	1.35(N)					
1000pF(102)	1.35(N)					
1500pF(152)					1.35(N)	
5600pF(562)				1.35(N)		
6800pF(682)				1.35(N)		
10000pF(103)			1.35(N)			
12000pF(123)			1.35(N)			

The part numbering code is shown in ().
Dimensions are shown in mm and Rated Voltage in Vdc.

Temperature Compensating Type GRM43 Series (4.50x3.20mm)

Part Number	GRM43					
L x W [EIA]	4.50x3.20 [1812]					
TC	COG (5C)			SL (1X)		
Rated Volt.	200 (2D)	500 (2H)	50 (1H)	100 (2A)	200 (2D)	500 (2H)
Capacitance and T Dimension						
220pF(221)		1.80(R)				
270pF(271)		1.80(R)				
330pF(331)		1.80(R)				
390pF(391)		1.80(R)				
470pF(471)		1.80(R)				
560pF(561)						1.15(M)
680pF(681)						1.15(M)
820pF(821)						1.35(N)
1000pF(102)						1.80(R)
1200pF(122)	1.80(R)					1.80(R)
1500pF(152)	1.80(R)					
1800pF(182)	1.80(R)				1.35(N)	
2200pF(222)	1.80(R)					
2700pF(272)	1.80(R)				1.80(R)	
3300pF(332)					1.80(R)	
3900pF(392)					1.80(R)	
8200pF(822)				1.35(N)		
10000pF(103)				1.80(R)		
12000pF(123)				1.80(R)		
15000pF(153)			1.80(R)	1.80(R)		

The part numbering code is shown in ().
Dimensions are shown in mm and Rated Voltage in Vdc.

Temperature Compensating Type GRM55 Series (5.70x5.00mm)

Part Number	GRM55					
L x W [EIA]	5.70x5.00 [2220]					
TC	COG (5C)			SL (1X)		
Rated Volt.	200 (2D)	500 (2H)	50 (1H)	100 (2A)	200 (2D)	
Capacitance and T Dimension						
560pF(561)		1.80(R)				
680pF(681)		1.80(R)				
820pF(821)		1.80(R)				
1000pF(102)		1.80(R)				
3300pF(332)	1.35(N)					
3900pF(392)	1.80(R)					
4700pF(472)	1.80(R)					1.35(N)
5600pF(562)	1.80(R)					1.80(R)
6800pF(682)						1.80(R)
8200pF(822)						1.80(R)
18000pF(183)			1.15(M)	1.15(M)		
22000pF(223)			1.35(N)	1.35(N)		
27000pF(273)			1.80(R)	1.80(R)		
33000pF(333)			1.80(R)	1.80(R)		
39000pF(393)			1.80(R)	1.80(R)		

The part numbering code is shown in ().
Dimensions are shown in mm and Rated Voltage in Vdc.

2

High Dielectric Constant Type GRM32 Series (3.20x2.50mm)

Part Number	GRM32							
L x W [EIA]	3.20x2.50 [1210]							
TC	X5R (R6)	X7R (R7)				Y5V (F5)		
Rated Volt.	10 (1A)	16 (1C)	25 (1E)	50 (1H)	100 (2A)	16 (1C)	25 (1E)	50 (1H)
Capacitance and T Dimension								
68000pF(683)					1.35(N)			
0.10μF(104)					1.35(N)			
0.68μF(684)				1.35(N)				
1.0μF(105)				1.80(R)				1.8(R)
2.2μF(225)		1.15(M)	1.80(R)					
3.3μF(335)		1.35(N)						
4.7μF(475)		1.80(R)					0.85(9)	
10μF(106)	2.50(E)					1.35(N)	1.35(N)	

The part numbering code is shown in ().
Dimensions are shown in mm and Rated Voltage in Vdc.

High Dielectric Constant Type GRM43 Series (4.50x3.20mm)

Part Number	GRM43	
L x W [EIA]	4.50x3.20 [1812]	
TC	X7R (R7)	
Rated Volt.	100 (2A)	
Capacitance and T Dimension		
0.15μF(154)	1.80(R)	
0.22μF(224)	1.80(R)	

The part numbering code is shown in ().
Dimensions are shown in mm and Rated Voltage in Vdc.

High Dielectric Constant Type GRM55 Series (5.70x5.00mm)

Part Number	GRM55	
L x W [EIA]	5.70x5.00 [2220]	
TC	X7R (R7)	
Rated Volt.	50 (1H)	100 (2A)
Capacitance and T Dimension		
0.33μF(334)	1.80(R)	
0.47μF(474)	1.80(R)	
1.0μF(105)	1.80(R)	
1.5μF(155)	1.80(R)	

The part numbering code is shown in ().
Dimensions are shown in mm and Rated Voltage in Vdc.

Chip Monolithic Ceramic Capacitors



Ultra-small GRP03 Series

■ Features

1. Small chip size (LxWxT:0.6x0.3x0.3mm).
2. Terminations are made of metal highly resistant to migration.
3. GRP03 type is suited to only reflow soldering.
4. Stringent dimensional tolerances are allow highly reliable, high speed autom atic chip placements on PCBs.
5. GRP03 series are suited to miniature micro wave module, portable equipment and high-frequency circuit.

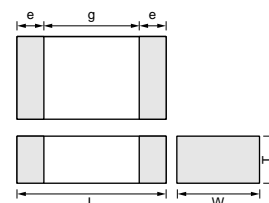

Part Number	Dimensions (mm)				
	L	W	T	e	g min.
GRP033	0.6 ±0.03	0.3 ±0.03	0.3 ±0.03	0.1 to 0.2	0.2

■ Applications

- Miniature micro wave module.
- Portable equipment.
- High-frequency circuit.

Part Number	GRP03			
L x W	0.6x0.3			
TC	C0G (5C)	X7R (R7)		Y5V (F5)
Rated Volt.	25 (1E)	6.3 (0J)	16 (1C)	10 (1A)
Capacitance and T Dimension				
0.5pF (R50)	0.3 (3)			
1pF (1R0)	0.3 (3)			
2pF (2R0)	0.3 (3)			
3pF (3R0)	0.3 (3)			
4pF (4R0)	0.3 (3)			
5pF (5R0)	0.3 (3)			
6pF (6R0)	0.3 (3)			
7pF (7R0)	0.3 (3)			
8pF (8R0)	0.3 (3)			
9pF (9R0)	0.3 (3)			
10pF (100)	0.3 (3)			
12pF (120)	0.3 (3)			
15pF (150)	0.3 (3)			
18pF (180)	0.3 (3)			
22pF (220)	0.3 (3)			
27pF (270)	0.3 (3)			
33pF (330)	0.3 (3)			
39pF (390)	0.3 (3)			
47pF (470)	0.3 (3)			
56pF (560)	0.3 (3)			
68pF (680)	0.3 (3)			
82pF (820)	0.3 (3)			
100pF (101)	0.3 (3)		0.3 (3)	
150pF (151)			0.3 (3)	
220pF (221)			0.3 (3)	
330pF (331)			0.3 (3)	
470pF (471)			0.3 (3)	
680pF (681)			0.3 (3)	

Continued on the following page.

 Continued from the preceding page.

Part Number	GRP03			
L x W	0.6x0.3			
TC	C0G (5C)	X7R (R7)		Y5V (F5)
Rated Volt.	25 (1E)	6.3 (0J)	16 (1C)	10 (1A)
Capacitance and T Dimension				
1000pF (102)			0.3 (3)	
1500pF (152)		0.3 (3)		
2200pF (222)		0.3 (3)		0.3 (3)
4700pF (472)		0.3 (3)		0.3 (3)
6800pF (682)		0.3 (3)		
10000pF (103)		0.3 (3)		0.3 (3)

The part numbering code is shown in ().
Dimensions are shown in mm and Rated Voltage in Vdc.

Chip Monolithic Ceramic Capacitors



Thin Type(Flow/Reflow)

■ Features

1. This series is suited to flow and reflow soldering.
Capacitor terminations are made of metal highly resistant to migration.
2. Large capacitance values enable excellent bypass effects to be realized.
3. Its thin package makes this series ideally suited for the production of small electronic products and for mounting underneath ICs.

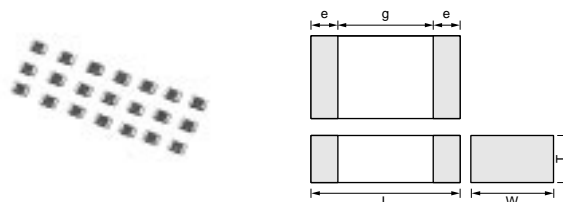

Part Number	Dimensions (mm)				
	L	W	T	e	g min.
GRP15X	1.0 ±0.05	0.5 ±0.05	0.25 ±0.05	0.15 to 0.3	0.4

■ Applicaton

Thin equipment such as IC cards.

Part Number	TC	Rated Voltage (Vdc)	Capacitance (pF)	Length L (mm)	Width W (mm)	Thickness T (mm)
GRP15X5C1E121JD11	C0G	25	120 ±5%	1.00	0.50	0.25
GRP15X5C1E151JD11	C0G	25	150 ±5%	1.00	0.50	0.25
GRP15X5C1E181JD11	C0G	25	180 ±5%	1.00	0.50	0.25
GRP15X5C1E221JD11	C0G	25	220 ±5%	1.00	0.50	0.25
GRP15X5C1H1R0CD11	C0G	50	1 ±0.25pF	1.00	0.50	0.25
GRP15X5C1H2R0CD11	C0G	50	2 ±0.25pF	1.00	0.50	0.25
GRP15X5C1H3R0CD11	C0G	50	3 ±0.25pF	1.00	0.50	0.25
GRP15X5C1H4R0CD11	C0G	50	4 ±0.25pF	1.00	0.50	0.25
GRP15X5C1H5R0CD11	C0G	50	5 ±0.25pF	1.00	0.50	0.25
GRP15X5C1H6R0DD11	C0G	50	6 ±0.5pF	1.00	0.50	0.25
GRP15X5C1H7R0DD11	C0G	50	7 ±0.5pF	1.00	0.50	0.25
GRP15X5C1H8R0DD11	C0G	50	8 ±0.5pF	1.00	0.50	0.25
GRP15X5C1H9R0DD11	C0G	50	9 ±0.5pF	1.00	0.50	0.25
GRP15X5C1H100JD11	C0G	50	10 ±0.5pF	1.00	0.50	0.25
GRP15X5C1H120JD11	C0G	50	12 ±5%	1.00	0.50	0.25
GRP15X5C1H150JD11	C0G	50	15 ±5%	1.00	0.50	0.25
GRP15X5C1H180JD11	C0G	50	18 ±5%	1.00	0.50	0.25
GRP15X5C1H220JD11	C0G	50	22 ±5%	1.00	0.50	0.25
GRP15X5C1H270JD11	C0G	50	27 ±5%	1.00	0.50	0.25
GRP15X5C1H330JD11	C0G	50	33 ±5%	1.00	0.50	0.25
GRP15X5C1H390JD11	C0G	50	39 ±5%	1.00	0.50	0.25
GRP15X5C1H470JD11	C0G	50	47 ±5%	1.00	0.50	0.25
GRP15X5C1H560JD11	C0G	50	56 ±5%	1.00	0.50	0.25
GRP15X5C1H680JD11	C0G	50	68 ±5%	1.00	0.50	0.25
GRP15X5C1H820JD11	C0G	50	82 ±5%	1.00	0.50	0.25
GRP15X5C1H101JD11	C0G	50	100 ±5%	1.00	0.50	0.25

GRP/GRM Series Specifications and Test Methods

No.	Item	Specification		Test Method																								
		Temperature Compensating Type	High Dielectric Type																									
1	Operating Temperature	-55 to +125°C	R6 : -55 to +85°C R7 : -55 to +125°C E4 : +10 to +85°C F5 : -30 to +85°C																									
2	Rated Voltage	See the previous page.		The rated voltage is defined as the maximum voltage which may be applied continuously to the capacitor. When AC voltage is superimposed on DC voltage, V ^{P-P} or V ^{O-P} , whichever is larger, shall be maintained within the rated voltage range.																								
3	Appearance	No defects or abnormalities.		Visual inspection.																								
4	Dimensions	Within the specified dimensions.		Using calipers on micrometer.																								
5	Dielectric Strength	No defects or abnormalities.		No failure shall be observed when *300% of the rated voltage (C0Δ to U2J and SL) or *250% of the rated voltage (X5R, X7R, Z5U and Y5V) is applied between the terminations for 1 to 5 seconds, provided the charge/discharge current is less than 50mA. *200% for 500V																								
6	Insulation Resistance	More than 10,000MΩ or 500Ω • F (Whichever is smaller)		The insulation resistance shall be measured with a DC voltage not exceeding the rated voltage at 25°C and 75%RH max. and within 2 minutes of charging.																								
7	Capacitance	Within the specified tolerance.		The capacitance/Q/D.F. shall be measured at 25°C at the frequency and voltage shown in the table.																								
8	Q/ Dissipation Factor (D.F.)	30pFmin. : Q≥1000 30pFmax. : Q≥400+20C C : Nominal Capacitance (pF)	[R6, R7] W.V. : 25Vmin. : 0.025max. W.V. : 16/10V : 0.035max. W.V. : 6.3V 0.05max.(C<3.3μF) 0.1max.(C≥3.3μF)	<table border="1"> <thead> <tr> <th>Item</th> <th>Char.</th> <th>Frequency</th> <th>Voltage</th> </tr> </thead> <tbody> <tr> <td>ΔC to 7U, 1X (1000pF and below)</td> <td></td> <td>1±0.1MHz</td> <td>0.5 to 5Vrms</td> </tr> <tr> <td>ΔC to 7U, 1X (more than 1000pF)</td> <td></td> <td>1±0.1kHz</td> <td>1±0.2Vrms</td> </tr> <tr> <td>R6, R7, F5 (10μF and below)</td> <td></td> <td>1±0.1kHz</td> <td>1±0.2Vrms</td> </tr> <tr> <td>R6, R7, F5 (more than 10μF)</td> <td></td> <td>120±24Hz</td> <td>0.5±0.1Vrms</td> </tr> <tr> <td>E4</td> <td></td> <td>1±0.1kHz</td> <td>0.5±0.05Vrms</td> </tr> </tbody> </table>	Item	Char.	Frequency	Voltage	ΔC to 7U, 1X (1000pF and below)		1±0.1MHz	0.5 to 5Vrms	ΔC to 7U, 1X (more than 1000pF)		1±0.1kHz	1±0.2Vrms	R6, R7, F5 (10μF and below)		1±0.1kHz	1±0.2Vrms	R6, R7, F5 (more than 10μF)		120±24Hz	0.5±0.1Vrms	E4		1±0.1kHz	0.5±0.05Vrms
			Item		Char.	Frequency	Voltage																					
ΔC to 7U, 1X (1000pF and below)		1±0.1MHz	0.5 to 5Vrms																									
ΔC to 7U, 1X (more than 1000pF)		1±0.1kHz	1±0.2Vrms																									
R6, R7, F5 (10μF and below)		1±0.1kHz	1±0.2Vrms																									
R6, R7, F5 (more than 10μF)		120±24Hz	0.5±0.1Vrms																									
E4		1±0.1kHz	0.5±0.05Vrms																									
[E4] W.V. : 25Vmin. : 0.025max. [F5] W.V. : 25Vmin. : 0.05max.(C<10μF) : 0.09max.(C≥1.0μF) W.V. : 16V : 0.07max.(C<1.0μF) : 0.09max.(C≥1.0μF) W.V. : 10Vmax. : 0.125max.																												
9	Capacitance Temperature Characteristics	Capacitance Change	Within the specified tolerance. (Table A)	<p>R6 : Within±15% (-55 to +85°C) R7 : Within±15% (-55 to +125°C) E4 : Within +22/-56% (+10 to +85°C) F5 : Within +22/-82% (-30 to +85°C)</p> <p>The capacitance change shall be measured after 5 Min. at each specified temperature stage. (1) Temperature Compensating Type The temperature coefficient is determined using the Capacitance measured in step 3 as a reference. When cycling the temperature sequentially from step 1 through 5 (C0Δ : +25°C to +125°C : other temp. coeffs. : +25°C to +85°C) the capacitance shall be within the specified tolerance for the temperature coefficient and capacitance change as Table A. The capacitance drift is calculated by dividing the differences between the maximum and minimum measured values in the step 1,3 and 5 by the cap value in step 3.</p> <table border="1"> <thead> <tr> <th>Step</th> <th>Temperature(°C)</th> </tr> </thead> <tbody> <tr> <td>1</td> <td>25±2</td> </tr> <tr> <td>2</td> <td>-55±3 (for ΔC to 7U/1X/R6/R7) -30±3 (for F5) 10±3 (for E4)</td> </tr> <tr> <td>3</td> <td>25±2</td> </tr> <tr> <td>4</td> <td>125±3 (for ΔC/R7) 85±3 (for other TC)</td> </tr> <tr> <td>5</td> <td>25±2</td> </tr> </tbody> </table> <p>(2) High Dielectric Constant Type The ranges of capacitance change compared with the above 25°C value over the temperature ranges shown in the table shall be within the specified ranges.</p>	Step	Temperature(°C)	1	25±2	2	-55±3 (for ΔC to 7U/1X/R6/R7) -30±3 (for F5) 10±3 (for E4)	3	25±2	4	125±3 (for ΔC/R7) 85±3 (for other TC)	5	25±2												
		Step	Temperature(°C)																									
		1	25±2																									
2	-55±3 (for ΔC to 7U/1X/R6/R7) -30±3 (for F5) 10±3 (for E4)																											
3	25±2																											
4	125±3 (for ΔC/R7) 85±3 (for other TC)																											
5	25±2																											
Temperature Coefficient	Within the specified tolerance. (Table A)	—																										
Capacitance Drift	Within ±0.2% or ±0.05pF (Whichever is larger.) *Not apply to 1X/25V	—																										

Continued on the following page. 

GRP/GRM Series Specifications and Test Methods

Continued from the preceding page.

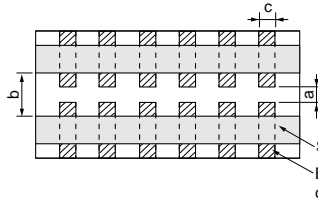
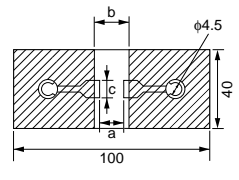
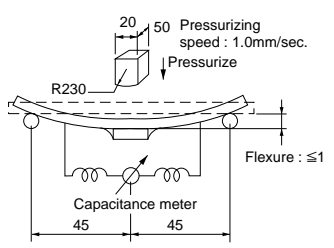
No.	Item	Specification		Test Method																																				
		Temperature Compensating Type	High Dielectric Type																																					
10	Adhesive Strength of Termination	No removal of the terminations or other defect shall occur.		<p>Solder the capacitor to the test jig (glass epoxy board) shown in Fig.1 using a eutectic solder. Then apply 10N* force in parallel with the test jig for 10±1sec. The soldering shall be done either with an iron or using the reflow method and shall be conducted with care so that the soldering is uniform and free of defects such as heat shock. *2N (GRP03) 5N (GRP15, GRM18)</p> <div style="text-align: center;">  <p style="font-size: small;">Solder resist Baked electrode or copper foil</p> <table border="1" style="margin: 10px auto; border-collapse: collapse;"> <thead> <tr> <th style="text-align: center;">Type</th> <th style="text-align: center;">a</th> <th style="text-align: center;">b</th> <th style="text-align: center;">c</th> </tr> </thead> <tbody> <tr><td style="text-align: center;">GRP03</td><td style="text-align: center;">0.3</td><td style="text-align: center;">0.9</td><td style="text-align: center;">0.3</td></tr> <tr><td style="text-align: center;">GRP15</td><td style="text-align: center;">0.4</td><td style="text-align: center;">1.5</td><td style="text-align: center;">0.5</td></tr> <tr><td style="text-align: center;">GRM18</td><td style="text-align: center;">1.0</td><td style="text-align: center;">3.0</td><td style="text-align: center;">1.2</td></tr> <tr><td style="text-align: center;">GRM21</td><td style="text-align: center;">1.2</td><td style="text-align: center;">4.0</td><td style="text-align: center;">1.65</td></tr> <tr><td style="text-align: center;">GRM31</td><td style="text-align: center;">2.2</td><td style="text-align: center;">5.0</td><td style="text-align: center;">2.0</td></tr> <tr><td style="text-align: center;">GRM32</td><td style="text-align: center;">2.2</td><td style="text-align: center;">5.0</td><td style="text-align: center;">2.9</td></tr> <tr><td style="text-align: center;">GRM43</td><td style="text-align: center;">3.5</td><td style="text-align: center;">7.0</td><td style="text-align: center;">3.7</td></tr> <tr><td style="text-align: center;">GRM55</td><td style="text-align: center;">4.5</td><td style="text-align: center;">8.0</td><td style="text-align: center;">5.6</td></tr> </tbody> </table> <p style="text-align: right; font-size: small;">(in mm)</p> </div> <p style="text-align: center; font-size: small;">Fig.1</p>	Type	a	b	c	GRP03	0.3	0.9	0.3	GRP15	0.4	1.5	0.5	GRM18	1.0	3.0	1.2	GRM21	1.2	4.0	1.65	GRM31	2.2	5.0	2.0	GRM32	2.2	5.0	2.9	GRM43	3.5	7.0	3.7	GRM55	4.5	8.0	5.6
Type	a	b	c																																					
GRP03	0.3	0.9	0.3																																					
GRP15	0.4	1.5	0.5																																					
GRM18	1.0	3.0	1.2																																					
GRM21	1.2	4.0	1.65																																					
GRM31	2.2	5.0	2.0																																					
GRM32	2.2	5.0	2.9																																					
GRM43	3.5	7.0	3.7																																					
GRM55	4.5	8.0	5.6																																					
11	Vibration Resistance	<p>Appearance No defects or abnormalities.</p> <p>Capacitance Within the specified tolerance.</p> <p>Q/D.F.</p> <p>30pFmin. : Q_≥1000 30pFmax. : Q_≥400+20C C : Nominal Capacitance (pF)</p>	<p>[R6, R7] W.V. : 25Vmin. : 0.025max. W.V. : 16/10V : 0.035max. W.V. : 6.3V : 0.05max. (C<3.3μF) 0.1max. (C_≥3.3μF)</p> <p>[E4] W.V. : 25Vmin. : 0.025max.</p> <p>[F5] W.V. : 25Vmin. : 0.05max. (C<1.0μF) : 0.09max. (C_≥1.0μF)</p> <p>W.V. : 16V : 0.07max. (C<1.0μF) : 0.09max. (C_≥1.0μF)</p> <p>W.V. : 10Vmax.:0.125max.</p>	<p>Solder the capacitor to the test jig (glass epoxy board) in the same manner and under the same conditions as (10). The capacitor shall be subjected to a simple harmonic motion having a total amplitude of 1.5mm, the frequency being varied uniformly between the approximate limits of 10 and 55Hz. The frequency range, from 10 to 55Hz and return to 10Hz, shall be traversed in approximately 1 minute. This motion shall be applied for a period of 2 hours in each 3 mutually perpendicular directions (total of 6 hours).</p>																																				
12	Deflection	No crack or marked defect shall occur.		<p>Solder the capacitor on the test jig (glass epoxy board) shown in Fig.2 using a eutectic solder. Then apply a force in the direction shown in Fig. 3. The soldering shall be done either with an iron or using the reflow method and shall be conducted with care so that the soldering is uniform and free of defects such as heat shock.</p> <div style="text-align: center;">  <table border="1" style="margin: 10px auto; border-collapse: collapse;"> <thead> <tr> <th style="text-align: center;">Type</th> <th style="text-align: center;">a</th> <th style="text-align: center;">b</th> <th style="text-align: center;">c</th> </tr> </thead> <tbody> <tr><td style="text-align: center;">GRP03</td><td style="text-align: center;">0.3</td><td style="text-align: center;">0.9</td><td style="text-align: center;">0.3</td></tr> <tr><td style="text-align: center;">GRP15</td><td style="text-align: center;">0.4</td><td style="text-align: center;">1.5</td><td style="text-align: center;">0.5</td></tr> <tr><td style="text-align: center;">GRM18</td><td style="text-align: center;">1.0</td><td style="text-align: center;">3.0</td><td style="text-align: center;">1.2</td></tr> <tr><td style="text-align: center;">GRM21</td><td style="text-align: center;">1.2</td><td style="text-align: center;">4.0</td><td style="text-align: center;">1.65</td></tr> <tr><td style="text-align: center;">GRM31</td><td style="text-align: center;">2.2</td><td style="text-align: center;">5.0</td><td style="text-align: center;">2.0</td></tr> <tr><td style="text-align: center;">GRM32</td><td style="text-align: center;">2.2</td><td style="text-align: center;">5.0</td><td style="text-align: center;">2.9</td></tr> <tr><td style="text-align: center;">GRM43</td><td style="text-align: center;">3.5</td><td style="text-align: center;">7.0</td><td style="text-align: center;">3.7</td></tr> <tr><td style="text-align: center;">GRM55</td><td style="text-align: center;">4.5</td><td style="text-align: center;">8.0</td><td style="text-align: center;">5.6</td></tr> </tbody> </table> <p style="text-align: right; font-size: small;">(in mm)</p> </div> <p style="text-align: center; font-size: small;">Fig.2</p> <div style="text-align: center;">  <p style="font-size: small;">Pressurizing speed : 1.0mm/sec. Pressurize R230 Capacitance meter Flexure : ≤1</p> <p style="text-align: center; font-size: small;">Fig.3</p> </div>	Type	a	b	c	GRP03	0.3	0.9	0.3	GRP15	0.4	1.5	0.5	GRM18	1.0	3.0	1.2	GRM21	1.2	4.0	1.65	GRM31	2.2	5.0	2.0	GRM32	2.2	5.0	2.9	GRM43	3.5	7.0	3.7	GRM55	4.5	8.0	5.6
Type	a	b	c																																					
GRP03	0.3	0.9	0.3																																					
GRP15	0.4	1.5	0.5																																					
GRM18	1.0	3.0	1.2																																					
GRM21	1.2	4.0	1.65																																					
GRM31	2.2	5.0	2.0																																					
GRM32	2.2	5.0	2.9																																					
GRM43	3.5	7.0	3.7																																					
GRM55	4.5	8.0	5.6																																					

Continued on the following page.

GRP/GRM Series Specifications and Test Methods

Continued from the preceding page.

No.	Item	Specification		Test Method	
		Temperature Compensating Type	High Dielectric Type		
13	Solderability of Termination	75% of the terminations is to be soldered evenly and continuously.		Immerse the capacitor in a solution of ethanol (JIS-K-8101) and rosin (JIS-K-5902) (25% rosin in weight proportion). Preheat at 80 to 120°C for 10 to 30 seconds. After preheating, immerse in eutectic solder solution for 2±0.5 seconds at 230±5°C.	
14	Resistance to Soldering Heat	The measured and observed characteristics shall satisfy the specifications in the following table.		Preheat the capacitor at 120 to 150°C for 1 minute. Immerse the capacitor in a eutectic solder solution at 270±5°C for 10±0.5 seconds. Let sit at room temperature for 24±2 hours (temperature compensating type) or 48±4 hours (high dielectric constant type), then measure. •Initial measurement for high dielectric constant type Perform a heat treatment at 150 ±18°C for one hour and then let sit for 48±4 hours at room temperature. Perform the initial measurement. *Preheating for GRM32/43/55	
		Appearance	No marking defects.		
		Capacitance Change	Within ±2.5% or ±0.25pF (Whichever is larger)		R6, R7 : Within ±7.5% E4, F5 : Within ±20%
		Q/D.F.	30pFmin. : Q≥1000 30pFmax. : Q≥400+20C C : Nominal Capacitance (pF)		[R6, R7] W.V. : 25Vmin. : 0.025max. W.V. : 16/10V : 0.035max. W.V. : 6.3V : 0.05max. (C<3.3μF) 0.1max. (C≥3.3μF) [E4] W.V. : 25Vmin. : 0.025max. [F5] W.V. : 25Vmin. : 0.05max. (C<1.0μF) : 0.09max. (C≥1.0μF) W.V.:16V : 0.07max. (C<1.0μF) : 0.09max. (C≥1.0μF) W.V. : 10Vmax. : 0.125max.
		I.R.	More than 10,000MΩ or 500Ω • F (Whichever is smaller)		
		Dielectric Strength	No failure		
15	Temperature Cycle	The measured and observed characteristics shall satisfy the specifications in the following table.		Fix the capacitor to the supporting jig in the same manner and under the same conditions as (10). Perform the five cycles according to the four heat treatments listed in the following table. Let sit for 24±2 hours (temperature compensating type) or 48±4 hour (high dielectric constant type) at room temperature, then measure.	
		Appearance	No marking defects.		
		Capacitance Change	Within ±2.5% or ±0.25pF (Whichever is larger)		R6, R7 : Within ±7.5% E4, F5 : Within ±20%
		Q/D.F.	30pFmin. : Q≥1000 30pFmax. : Q≥400+20C C : Nominal Capacitance (pF)		[R6, R7] W.V. : 25Vmin. : 0.025max. W.V. : 16/10V : 0.035max. W.V. : 6.3V 0.05max. (C<3.3μF) 0.1max. (C≥3.3μF) [E4] W.V. : 2.5Vmin. : 0.025max. [F5] W.V. : 25Vmin. : 0.05max. (C<1.0μF) : 0.09max. (C≥1.0μF) W.V. : 16V : 0.07max. (C<1.0μF) : 0.09max. (C≥1.0μF) W.V. : 10Vmax. : 0.125max.
		I.R.	More than 10,000MΩ or 500Ω • F (Whichever is smaller)		
		Dielectric Strength	No failure		

Step	Temperature	Time
1	100°C to 120°C	1 min.
2	170°C to 200°C	1 min.

Step	1	2	3	4
Temp.(°C)	Min. Operating Temp.+0/-3	Room Temp.	Max. Operating Temp.+3/-0	Room Temp.
Time(min.)	30±3	2 to 3	30±3	2 to 3

Continued on the following page.

GRP/GRM Series Specifications and Test Methods

Continued from the preceding page.

No.	Item	Specification		Test Method	
		Temperature Compensating Type	High Dielectric Type		
16	Humidity Steady State	The measured and observed characteristics shall satisfy the specifications in the following table.		Sit the capacitor at 40±2°C and 90 to 95% humidity for 500±12 hours. Remove and let sit for 24±2 hours (temperature compensating type) or 48±4 hours (high dielectric constant type) at room temperature, then measure.	
		Appearance	No marking defects.		
		Capacitance Change	Within ±5% or ±0.5pF (Whichever is larger)		R6, R7 : Within ±12.5% E4, F5 : Within ±30%
		Q/D.F.	30pF and over : $Q \geq 350$ 10pF and over 30pF and below : $Q \geq 275 + 5C/2$ 10pF and below : $Q \geq 200 + 10C$ C : Nominal Capacitance (pF)		[R6, R7] W.V. : 25Vmin. : 0.05max. W.V. : 16/10V : 0.05max. W.V. : 6.3V 0.075max. (C<3.3µF) 0.125max. (C≥3.3µF) [E4] W.V. : 25Vmin. : 0.05max. [F5] W.V. : 25Vmin. : 0.075max. (C<1.0µF) : 0.0125max. (C≥1.0µF) W.V. : 16V : 0.1max. (C<1.0µF) : 0.125max. (C≥1.0µF) W.V. : 10Vmax. : 0.15max.
		I.R.	More than 1,000MΩ or 50Ω • F (Whichever is smaller)		
		Dielectric Strength	No failure		
17	Humidity Load	The measured and observed characteristics shall satisfy the specifications in the following table.		Apply the rated voltage at 40±2°C and 90 to 95% humidity for 500±12 hours. Remove and let sit for 24±2 hours (temperature compensating type) or 48±4 hours (high dielectric constant type) at room temperature, then measure. The charge/discharge current is less than 50mA. •Initial measurement for F5/10Vmax. Apply the rated DC voltage for 1 hour at 40±2°C. Remove and let sit for 48±4 hours at room temperature. Perform initial measurement.	
		Appearance	No marking defects.		
		Capacitance Change	Within ±7.5% or ±0.75pF (Whichever is larger)		R6, R7 : Within ±12.5% E4 : Within ±30% F5 : Within ±30% [W.V. : 10Vmax.] F5 : Within +30/-40%
		Q/D.F.	30pF and over : $Q \geq 200$ 30pF and below : $Q \geq 100 \pm 10C/3$ C : Nominal Capacitance (pF)		[R6, R7] W.V. : 25Vmin. : 0.05max. W.V. : 16/10V : 0.05max. W.V. : 6.3V 0.075max. (C<3.3µF) 0.125max. (C≥3.3µF) [E4] W.V. : 25Vmin. : 0.05max. [F5] W.V. : 25Vmin. : 0.075max. (C<1.0µF) : 0.0125max. (C≥1.0µF) W.V. : 16V : 0.1max. (C<1.0µF) : 0.125max. (C≥1.0µF) W.V. : 10Vmax. : 0.15max.
		I.R.	More than 500MΩ or 25Ω • F (Whichever is smaller)		
		Dielectric Strength	No failure		

Continued on the following page.

GRP/GRM Series Specifications and Test Methods

 Continued from the preceding page.

No.	Item	Specification		Test Method	
		Temperature Compensating Type	High Dielectric Type		
18	High Temperature Load	The measured and observed characteristics shall satisfy the specifications in the following table.			Apply 200% of the rated voltage for 1000±12 hours at the maximum operating temperature ±3°C. Let sit for 24±2 hours (temperature compensating type) or 48±4 hours (high dielectric constant type) at room temperature, then measure. The charge/discharge current is less than 50mA. •Initial measurement for high dielectric constant type. Apply 200% of the rated DC voltage for one hour at the maximum operating temperature ±3°C. Remove and let sit for 48±4 hours at room temperature. Perform initial measurement. *150% for 500V and C≥10μF
		Appearance	No marking defects.		
		Capacitance Change	Within ±3% or ±0.3pF (Whichever is larger)	R6, R7 : Within ±12.5% E4 : Within ±30% F5 : Within ±30% (Cap<1.0μF) F5 : Within +30/-40%(Cap≥1.0μF)	
		Q/D.F.	30pF and over : Q≥350 10pF and over : Q≥275±5C/2 30pF and below : Q≥200±10C C : Nominal Capacitance (pF)	[R6, R7] W.V. : 25Vmin. : 0.05max. W.V. : 16/10V : 0.05max. W.V. : 6.3V : 0.075max. (C<3.3μF) : 0.125max. (C≥3.3μF) [E4] W.V. : 25Vmin. : 0.05max [F5] W.V. : 25Vmin. : 0.075max. (C<1.0μF) : 0.0125max.(C≥1.0μF) W.V. : 16V : 0.1max. (C<1.0μF) : 0.125max. (C≥1.0μF) W.V. : 10Vmax. : 0.15max.	
		I.R.	More than 1,000MΩ or 50Ω•F(Whichever is smaller)		
		Dielectric Strength	No failure		
19	Notice	When mounting capacitor of 500V rated voltage, perform the epoxy resin coating(min.1.0mm thickness)			

Table A

Char. Code	Nominal Values (ppm/°C)*	Capacitance Change from 25°C (%)					
		-55		-30		-10	
		Max.	Min.	Max.	Min.	Max.	Min.
5C	0± 30	0.58	-0.24	0.40	-0.17	0.25	-0.11
6C	0± 60	0.87	-0.48	0.59	-0.33	0.38	-0.21
6P	-150± 60	2.33	0.72	1.61	0.50	1.02	0.32
6R	-220± 60	3.02	1.28	2.08	0.88	1.32	0.56
6S	-330± 60	4.09	2.16	2.81	1.49	1.79	0.95
6T	-470± 60	5.46	3.28	3.75	2.26	2.39	1.44
7U	-750±120	8.78	5.04	6.04	3.47	3.84	2.21
1X	+350 to -1000	-	-	-	-	-	-

*Nominal values denote the temperature coefficient within a range of 25°C to 125°C (for ΔC)/85°C (for other TC).

Chip Monolithic Ceramic Capacitors



High-power Type

■ Features

1. Mobile Telecommunication and RF module, mainly.
2. Quality improvement of telephone call, Low power consumption, yield ratio improvement.

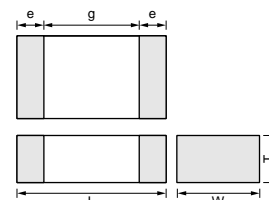

■ Applications

VCO, PA, Mobile Telecommunication

Part Number	Dimensions (mm)				
	L	W	T	e	g min.
GJ6155	1.0 ±0.05	0.5 ±0.05	0.5 ±0.05	0.15 to 0.3	0.4

Part Number	TC	Rated Voltage (Vdc)	Capacitance (pF)	Length L (mm)	Width W (mm)	Thickness T (mm)
GJ61555C1HR50BB01	C0G	50	0.5 ±0.1pF	1.00	0.50	0.50
GJ61555C1HR50CB01	C0G	50	0.50 ±0.25pF	1.00	0.50	0.50
GJ61555C1HR75BB01	C0G	50	0.75 ±0.1pF	1.00	0.50	0.50
GJ61555C1HR75CB01	C0G	50	0.75 ±0.25pF	1.00	0.50	0.50
GJ61555C1H1R0BB01	C0G	50	1.0 ±0.1pF	1.00	0.50	0.50
GJ61555C1H1R0CB01	C0G	50	1.0 ±0.25pF	1.00	0.50	0.50
GJ61555C1H1R1BB01	C0G	50	1.1 ±0.1pF	1.00	0.50	0.50
GJ61555C1H1R2BB01	C0G	50	1.2 ±0.1pF	1.00	0.50	0.50
GJ61555C1H1R3BB01	C0G	50	1.3 ±0.1pF	1.00	0.50	0.50
GJ61555C1H1R5BB01	C0G	50	1.5 ±0.1pF	1.00	0.50	0.50
GJ61555C1H1R5CB01	C0G	50	1.5 ±0.25pF	1.00	0.50	0.50
GJ61555C1H1R6BB01	C0G	50	1.6 ±0.1pF	1.00	0.50	0.50
GJ61555C1H1R8BB01	C0G	50	1.8 ±0.1pF	1.00	0.50	0.50
GJ61555C1H2R0BB01	C0G	50	2.0 ±0.1pF	1.00	0.50	0.50
GJ61555C1H2R0CB01	C0G	50	2.0 ±0.25pF	1.00	0.50	0.50
GJ61555C1H2R2BB01	C0G	50	2.2 ±0.1pF	1.00	0.50	0.50
GJ61555C1H2R4BB01	C0G	50	2.4 ±0.1pF	1.00	0.50	0.50
GJ61555C1H2R7BB01	C0G	50	2.7 ±0.1pF	1.00	0.50	0.50
GJ61555C1H3R0BB01	C0G	50	3.0 ±0.1pF	1.00	0.50	0.50
GJ61555C1H3R0CB01	C0G	50	3.0 ±0.25pF	1.00	0.50	0.50
GJ61555C1H3R3BB01	C0G	50	3.3 ±0.1pF	1.00	0.50	0.50
GJ61555C1H3R6BB01	C0G	50	3.6 ±0.1pF	1.00	0.50	0.50
GJ61555C1H3R9BB01	C0G	50	3.9 ±0.1pF	1.00	0.50	0.50
GJ61555C1H4R0BB01	C0G	50	4.0 ±0.1pF	1.00	0.50	0.50
GJ61555C1H4R0CB01	C0G	50	4.0 ±0.25pF	1.00	0.50	0.50
GJ61555C1H4R3BB01	C0G	50	4.3 ±0.1pF	1.00	0.50	0.50
GJ61555C1H4R7BB01	C0G	50	4.7 ±0.1pF	1.00	0.50	0.50
GJ61555C1H5R0BB01	C0G	50	5.0 ±0.1pF	1.00	0.50	0.50
GJ61555C1H5R0CB01	C0G	50	5.0 ±0.25pF	1.00	0.50	0.50
GJ61555C1H5R1CB01	C0G	50	5.1 ±0.25pF	1.00	0.50	0.50
GJ61555C1H5R6CB01	C0G	50	5.6 ±0.25pF	1.00	0.50	0.50
GJ61555C1H6R0CB01	C0G	50	6.0 ±0.25pF	1.00	0.50	0.50
GJ61555C1H6R0DB01	C0G	50	6.0 ±0.5pF	1.00	0.50	0.50
GJ61555C1H6R2CB01	C0G	50	6.2 ±0.25pF	1.00	0.50	0.50
GJ61555C1H6R8CB01	C0G	50	6.8 ±0.25pF	1.00	0.50	0.50
GJ61555C1H7R0CB01	C0G	50	7.0 ±0.25pF	1.00	0.50	0.50
GJ61555C1H7R0DB01	C0G	50	7.0 ±0.5pF	1.00	0.50	0.50
GJ61555C1H7R5CB01	C0G	50	7.5 ±0.25pF	1.00	0.50	0.50

Continued on the following page.

 Continued from the preceding page.

Part Number	TC	Rated Voltage (Vdc)	Capacitance (pF)	Length L (mm)	Width W (mm)	Thickness T (mm)
GJ61555C1H8R0CB01	C0G	50	8.0 ±0.25pF	1.00	0.50	0.50
GJ61555C1H8R0DB01	C0G	50	8.0 ±0.5pF	1.00	0.50	0.50
GJ61555C1H8R2CB01	C0G	50	8.2 ±0.25pF	1.00	0.50	0.50
GJ61555C1H9R0CB01	C0G	50	9.0 ±0.25pF	1.00	0.50	0.50
GJ61555C1H9R0DB01	C0G	50	9.0 ±0.5pF	1.00	0.50	0.50
GJ61555C1H9R1CB01	C0G	50	9.1 ±0.25pF	1.00	0.50	0.50
GJ61555C1H100JB01	C0G	50	10.0 ±0.5pF	1.00	0.50	0.50
GJ61555C1H100RB01	C0G	50	10 ±0.25pF	1.00	0.50	0.50
GJ61555C1H120GB01	C0G	50	12 ±2%	1.00	0.50	0.50
GJ61555C1H120JB01	C0G	50	12 ±5%	1.00	0.50	0.50
GJ61555C1H150GB01	C0G	50	15 ±2%	1.00	0.50	0.50
GJ61555C1H150JB01	C0G	50	15 ±5%	1.00	0.50	0.50
GJ61555C1H180GB01	C0G	50	18 ±2%	1.00	0.50	0.50
GJ61555C1H180JB01	C0G	50	18 ±5%	1.00	0.50	0.50
GJ61555C1H200GB01	C0G	50	20 ±2%	1.00	0.50	0.50

Specifications and Test Methods

No.	Item	Specification		Test Method									
		Temperature Compensating Type											
1	Operating Temperature Range	-55 to +125°C											
2	Rated Voltage	See the previous pages.		The rated voltage is defined as the maximum voltage which may be applied continuously to the capacitor. When AC voltage is superimposed on DC voltage, V^{P-P} or V^{O-P} , whichever is larger, shall be maintained within the rated voltage range.									
3	Appearance	No defects or abnormalities.		Visual inspection.									
4	Dimensions	Within the specified dimensions.		Using calipers.									
5	Dielectric Strength	No defects or abnormalities.		No failure shall be observed when 300% of the rated voltage is applied between the terminations for 1 to 5 seconds, provided the charge/discharge current is less than 50mA.									
6	Insulation Resistance (I.R.)	10,000MΩ min. or 500Ω • F min. (Whichever is smaller)		The insulation resistance shall be measured with a DC voltage not exceeding the rated voltage at 25°C and 75%RH max. and within 2 minutes of charging.									
7	Capacitance	Within the specified tolerance.		The capacitance/Q shall be measured at 25°C at the frequency and voltage shown in the table.									
8	Q	30pF min. : $Q \geq 1,000$ 30pF max. : $Q \geq 400+20C$ C : Nominal Capacitance (pF)		<table border="1" style="width: 100%; border-collapse: collapse;"> <thead> <tr> <th>Item</th> <th>Char.</th> <th>C0G(1000pF and below)</th> </tr> </thead> <tbody> <tr> <td>Frequency</td> <td></td> <td>1±0.1MHz</td> </tr> <tr> <td>Voltage</td> <td></td> <td>0.5 to 5Vr.m.s.</td> </tr> </tbody> </table>	Item	Char.	C0G(1000pF and below)	Frequency		1±0.1MHz	Voltage		0.5 to 5Vr.m.s.
Item	Char.	C0G(1000pF and below)											
Frequency		1±0.1MHz											
Voltage		0.5 to 5Vr.m.s.											
9	Capacitance Temperature Characteristics	Capacitance Change	Within the specified tolerance. (Table A-1)	The capacitance change shall be measured after 5 min. at each specified temperature stage. Temperature Compensating Type The temperature coefficient is determined using the capacitance measured in step 3 as a reference. When cycling the temperature sequentially from step 1 through 5, (C0G : +25°C to +125°C : other temp. coeffs. : +25°C to 85°C) the capacitance shall be within the specified tolerance for the temperature coefficient and capacitance change as Table A. The capacitance drift is calculated by dividing the differences between the maximum and minimum measured values in the step 1, 3 and 5 by the cap value in step 3.									
		Temperature Coefficient	Within the specified tolerance. (Table A-1)										
		Capacitance Drift	Within ±0.2% or ±0.05pF (Whichever is larger.)										
10	Adhesive Strength of Termination	No removal of the terminations or other defect shall occur.		Solder the capacitor to the test jig (glass epoxy board) shown in Fig.1 using a eutectic solder. Then apply a 5N force in parallel with the test jig for 10±1sec. The soldering shall be done either with an iron or using the reflow method and shall be conducted with care so that the soldering is uniform and free of defects such as heat shock.									

Step	Temperature(°C)
1	25±2
2	-55±3
3	25±2
4	125±3
5	25±2

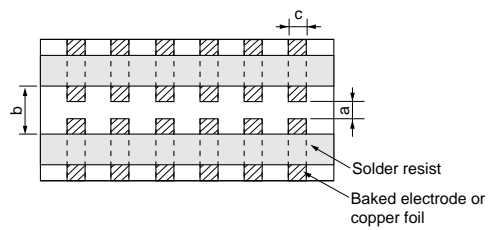

Type	a	b	c
GJ615	0.4	1.5	0.5

Fig.1

Continued on the following page.

5

Specifications and Test Methods

Continued from the preceding page.

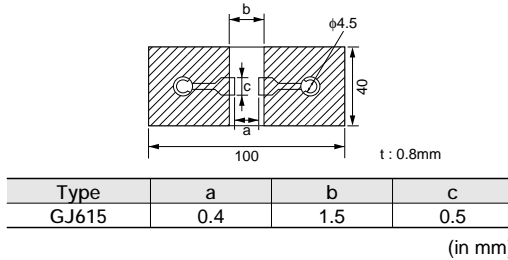
No.	Item	Specification		Test Method					
		Temperature Compensating Type							
11	Vibration Resistance	Appearance	No defects or abnormalities.	Solder the capacitor to the test jig (glass epoxy board) in the same manner and under the same conditions as (10). The capacitor shall be subjected to a simple harmonic motion having a total amplitude of 1.5mm, the frequency being varied uniformly between the approximate limits of 10 and 55Hz. The frequency range, from 10 to 55Hz and return to 10Hz, shall be traversed in approximately 1 minute. This motion shall be applied for a period of 2 hours in each 3 mutually perpendicular directions (total of 6 hours).					
		Capacitance	Within the specified tolerance.						
		Q	30pF min. : $Q \geq 1,000$ 30pF max. : $Q \geq 400+20C$ C : Nominal Capacitance (pF)						
12	Deflection	No cracking or marking defects shall occur.		Solder the capacitor to the test jig (glass epoxy boards) shown in Fig.2 using a eutectic solder. Then apply a force in the direction shown in Fig.3. The soldering shall be done either with an iron or using the reflow method and shall be conducted with care so that the soldering is uniform and free of defects such as heat shock..					
		 <table border="1" data-bbox="367 862 877 918"> <thead> <tr> <th>Type</th> <th>a</th> <th>b</th> <th>c</th> </tr> </thead> <tbody> <tr> <td>GJ615</td> <td>0.4</td> <td>1.5</td> <td>0.5</td> </tr> </tbody> </table> <p>(in mm)</p>			Type	a	b	c	GJ615
Type	a	b	c						
GJ615	0.4	1.5	0.5						
13	Solderability of Termination	75% of the terminations is to be soldered evenly and continuously.		Immerse the capacitor in a solution of ethanol (JIS-K-8101) and rosin (JIS-K-5902) (25% rosin in weight proportion). Preheat at 80 to 120°C for 10 to 30 seconds. After preheating, immerse in eutectic solder solution for 2 ± 0.5 seconds at $230 \pm 5^\circ\text{C}$.					
14	Resistance to Soldering Heat	The measured and observed characteristics shall satisfy the specifications in the following table.		Preheat the capacitor at 120 to 150°C for 1 minute. Immerse the capacitor in a eutectic solder solution at $270 \pm 5^\circ\text{C}$ for 10 ± 0.5 seconds. Let sit at room temperature for 24 ± 2 hours.					
		Appearance	No marking defects.						
		Capacitance Change	Within $\pm 2.5\%$ or $\pm 0.25\text{pF}$ (Whichever is larger)						
		Q	30pF and over : $Q \geq 1,000$ 30pF and below : $Q \geq 400+20C$ C : Nominal Capacitance (pF)						
		I.R.	More than $10,000\text{M}\Omega$ or $500\Omega \cdot F$ (Whichever is smaller)						
15	Temperature Cycle	The measured and observed characteristics shall satisfy the specifications in the following table.		Fix the capacitor to the supporting jig in the same manner and under the same conditions as (10). Perform the five cycles according to the four heat treatments listed in the following table. Let sit for 24 ± 2 hours at room temperature, then measure.					
		Appearance	No marking defects.						
		Capacitance Change	Within $\pm 2.5\%$ or $\pm 0.25\text{pF}$ (Whichever is larger)						
		Q	30pF and over : $Q \geq 1,000$ 30pF and below : $Q \geq 400+20C$ C : Nominal Capacitance (pF)						
		I.R.	More than $10,000\text{M}\Omega$ or $500\Omega \cdot F$ (Whichever is smaller)						
16	Humidity, Steady State	The measured and observed characteristics shall satisfy the specifications in the following table.		Sit the capacitor at $40 \pm 2^\circ\text{C}$ and 90 to 95% humidity for 500 ± 12 hours. Remove and let sit for 24 ± 2 hours (temperature compensating type) at room temperature, then measure.					
		Appearance	No marking defects.						
		Capacitance Change	Within $\pm 5\%$ or $\pm 0.5\text{pF}$ (Whichever is larger)						
		Q	30pF and over. : $Q \geq 350$ 10pF and over, 30pF and below : $Q \geq 275 + \frac{C}{2}$ 10pF and below : $Q \geq 200+10C$ C : Nominal Capacitance (pF)						
		I.R.	More than $10,000\text{M}\Omega$ or $500\Omega \cdot F$ (Whichever is smaller)						

5

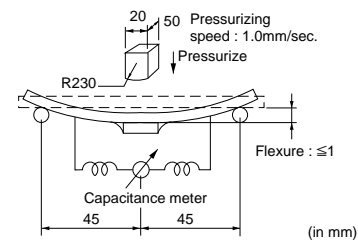



Fig.3

Continued on the following page. 

Specifications and Test Methods

 Continued from the preceding page.

No.	Item	Specification		Test Method
		Temperature Compensating Type		
17	Humidity Load	The measured and observed characteristics shall satisfy the specifications in the following table.		Apply the rated voltage at 40±2°C and 90 to 95% humidity for 500±12 hours. Remove and let sit for 24±2 hours at room temperature, then measure. The charge/discharge current is less than 50mA.
		Appearance	No marking defects.	
		Capacitance Change	Within ±7.5% or ±0.75pF (Whichever is larger)	
		Q	30pF and over : Q≥200 30pF and below : Q≥100+ $\frac{10}{C}$ C C : Nominal Capacitance (pF)	
		I.R.	More than 500MΩ or 25Ω • F (Whichever is smaller)	
	Dielectric Strength	No failure		
18	High Temperature Load	The measured and observed characteristics shall satisfy the specifications in the following table.		Apply 200% of the rated voltage for 1000±12 hours at the maximum operating temperature ±3°C. Let sit for 24±2 hours (temperature compensating type) at room temperature, then measure. The charge/discharge current is less than 50mA.
		Appearance	No marking defects.	
		Capacitance Change	Within ±3% or ±0.3pF (Whichever is larger)	
		Q	30pF and over. : Q≥350 10pF and over, 30pF and below : Q≥275+ $\frac{5}{C}$ C 10pF and below : Q≥200+10C C : Nominal Capacitance (pF)	
		I.R.	More than 1,000MΩ or 50Ω • F (Whichever is smaller)	
	Dielectric Strength	No failure		
19	ESR	0.5pF<C≤1pF : 350mΩ . pF below 1pF<C≤5pF : 300mΩ below 5pF<C≤10pF : 250mΩ below		The ESR shall be measured at room Temp. and frequency 1±0.2GHz with the equivalent of BOONTON Model 34A.
		10pF<C≤20pF : 400mΩ below		The ESR shall be measured at room Temp. and frequency 500±50MHz with the equivalent of HP8753B.

5

Table A

Char. Code	Temp. Coeff. (ppm/°C) Note 1	Capacitance Change from 25°C Value (%)					
		-55°C		-30°C		-10°C	
		Max.	Min.	Max.	Min.	Max.	Min.
5C	0±30	0.58	-0.24	0.40	-0.17	0.25	-0.11

Note 1 : Nominal values denote the temperature coefficient within a range of 25 to 125°C.(for C0Δ)

GRP/GRM Series Data

Capacitance-Temperature Characteristics

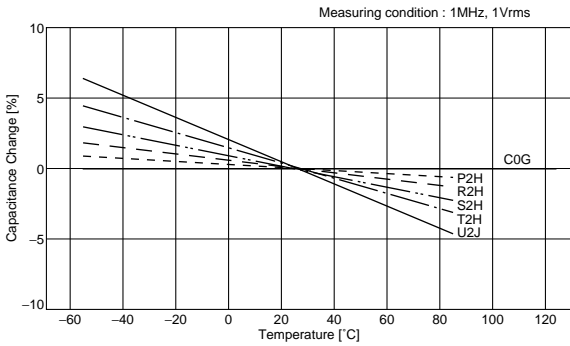

Capacitance-DC Voltage Characteristics

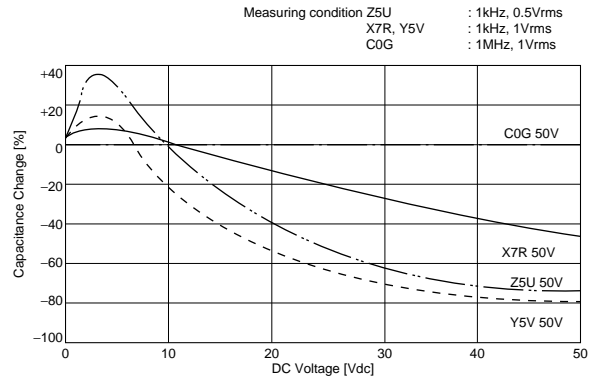

Capacitance-AC Voltage Characteristics

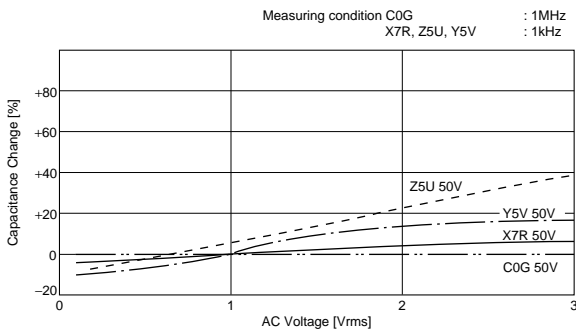

Capacitance Change-Aging

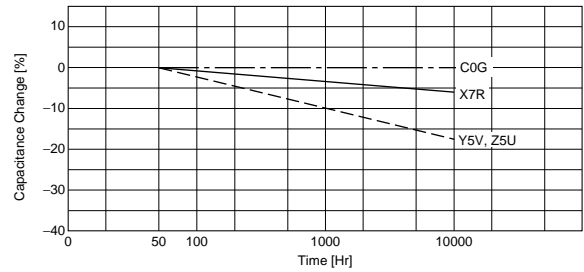

Impedance-Frequency Characteristics

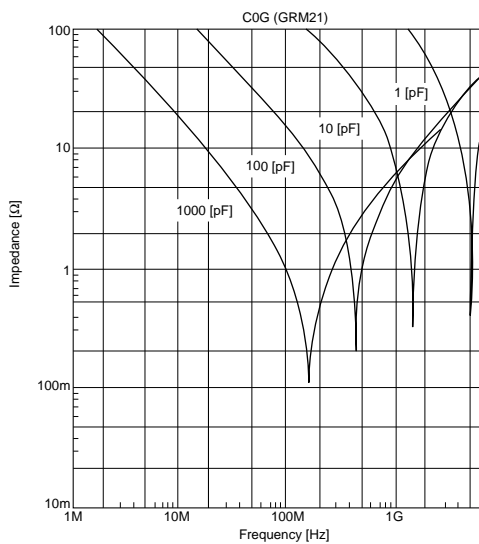

Allowable Voltage-Frequency

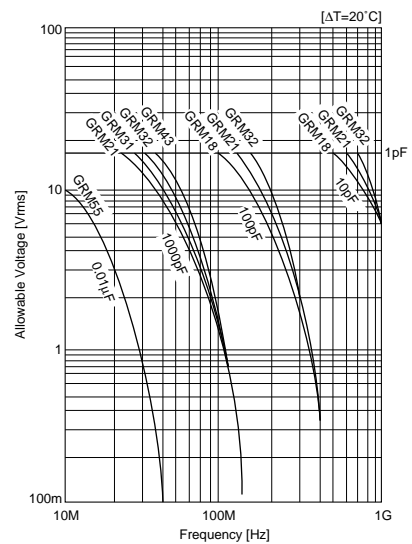

Continued on the following page.

GRP/GRM Series Data

Continued from the preceding page.

Allowable Current-Frequency

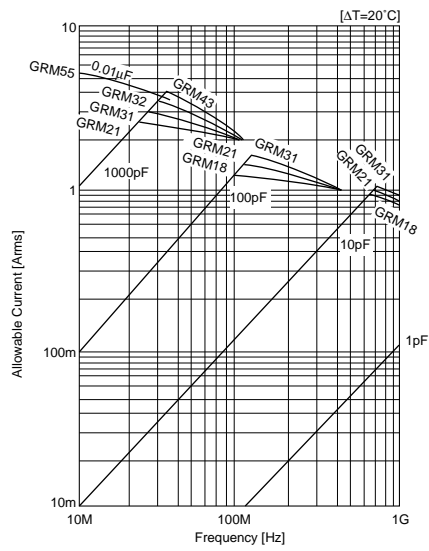

Allowable Apparent Power

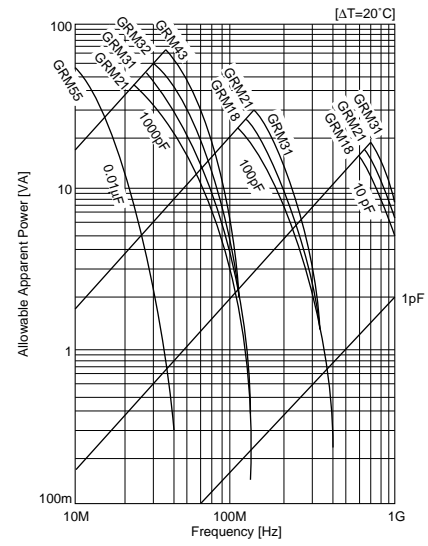

Chip Monolithic Ceramic Capacitors



for Smoothing

■ Features

1. Heat generation is low at high frequency because of low dielectric loss.
2. Compared with aluminum electrolytic capacitors, capacitance can be lower to obtain the same smoothing performance.
3. Ceramic capacitor has no polarity and ensures long life time.

■ Applications

- DC-DC converter
- Noise elimination LCD bias circuit
(Use for only alumina, paper or glass epoxy board)

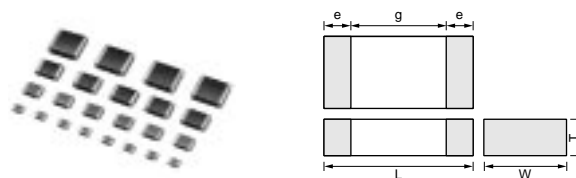

Part Number	Dimensions (mm)				
	L	W	T	e min.	g min.
GJ221B	2.0 ±0.1	1.25 ±0.1	1.25 ±0.1	0.2 to 0.7	0.7
GJ231M	3.2 ±0.15	1.6 ±0.15	1.15 ±0.1	0.3 to 0.8	1.5
GJ232N	3.2 ±0.3	2.5 ±0.2	1.35 ±0.15	0.3	1.0
GJ232C			1.6 ±0.15		
GJ232R			1.8 ±0.2		
GJ243R	4.5 ±0.4	3.2 ±0.3	1.8 ±0.2	0.3	2.0
GJ243X			2.2 ±0.3		

Part Number	TC	Rated Voltage (Vdc)	Capacitance (μF)	Length L (mm)	Width W (mm)	Thickness T (mm)
GJ221BF50J106ZD01	Y5V	6.3	10 +80.-20%	2.00	1.25	1.25
GJ231MF50J226ZD01	Y5V	6.3	22 +80.-20%	3.20	1.60	1.15
GJ232CF50J476ZD01	Y5V	6.3	47 +80.-20%	3.20	2.50	1.60
GJ243RF50J107ZD11	Y5V	6.3	100 +80.-20%	4.50	3.20	1.80
GJ232NF51A226ZD01	Y5V	10	22 +80.-20%	3.20	2.50	1.35
GJ232RF51H475ZD01	Y5V	50	4.7 +80.-20%	3.20	2.50	1.80
GJ243XF51H106ZD12	Y5V	50	10 +80.-20%	4.50	3.20	2.20
GJ232RF52A105ZD01	Y5V	100	1 +80.-20%	3.20	2.50	1.8

6

Specifications and Test Methods

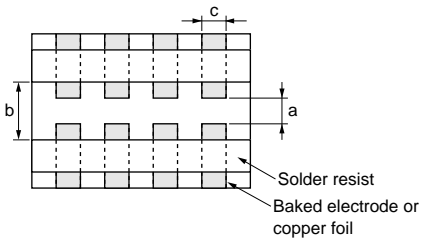
No.	Item	Specification	Test Method																								
1	Operating Temperature Range	F5 : -30°C to 85°C																									
2	Rated Voltage	See the previous pages.	The rated voltage is defined as the maximum voltage which may be applied continuously to the capacitor. When AC voltage is superimposed on DC voltage, V^{P-P} or V^{O-P} , whichever is larger, shall be maintained within the rated voltage range.																								
3	Appearance	No defects or abnormalities.	Visual inspection.																								
4	Dimensions	Within the specified dimension.	Using calipers.																								
5	Dielectric Strength	No defects or abnormalities.	No failure shall be observed when 250% of the rated voltage is applied between the both terminations for 1 to 5 seconds, provided the charge/discharge current is less than 50mA.																								
6	Insulation Resistance	More than 10,000MΩ or 500Ω · F. (Whichever is smaller)	The insulation resistance shall be measured with a DC voltage not exceeding the rated voltage at normal temperature and humidity and within 2 minutes* of charging. *5minutes for $c > 47\mu F$.																								
7	Capacitance	Within the specified tolerance.	The capacitance/D.F. shall be measured at 25°C at the frequency and voltage shown in the table.																								
8	Dissipation Factor (D.F.)	0.07 max. (50/100V) 0.09 max. (10/16/25V) 0.15 max. (6.3V)	<table border="1" style="margin-left: auto; margin-right: auto;"> <thead> <tr> <th>Capacitance</th> <th>Frequency</th> <th>Voltage</th> </tr> </thead> <tbody> <tr> <td>$C \leq 10\mu F$</td> <td>$1 \pm 0.1kHz$</td> <td>$1 \pm 0.2V_{rms}$</td> </tr> <tr> <td>$C > 10\mu F$</td> <td>$120 \pm 24Hz$</td> <td>$0.5 \pm 0.1V_{rms}$</td> </tr> </tbody> </table>	Capacitance	Frequency	Voltage	$C \leq 10\mu F$	$1 \pm 0.1kHz$	$1 \pm 0.2V_{rms}$	$C > 10\mu F$	$120 \pm 24Hz$	$0.5 \pm 0.1V_{rms}$															
Capacitance	Frequency	Voltage																									
$C \leq 10\mu F$	$1 \pm 0.1kHz$	$1 \pm 0.2V_{rms}$																									
$C > 10\mu F$	$120 \pm 24Hz$	$0.5 \pm 0.1V_{rms}$																									
9	Capacitance Temperature Characteristics	<table border="1" style="margin-left: auto; margin-right: auto;"> <thead> <tr> <th>Char.</th> <th>Temp. Range</th> <th>Reference Temp.</th> <th>Cap. Change Rate</th> </tr> </thead> <tbody> <tr> <td>F5</td> <td>-30 to +85°C</td> <td>25°C</td> <td>Within $\pm \frac{22}{82}\%$</td> </tr> </tbody> </table>	Char.	Temp. Range	Reference Temp.	Cap. Change Rate	F5	-30 to +85°C	25°C	Within $\pm \frac{22}{82}\%$	The capacitance change shall be measured after 5 min. at each specified temperature stage. The ranges of capacitance change compared to 25°C with the temperature ranges shown in the table shall be within the specified ranges.																
Char.	Temp. Range	Reference Temp.	Cap. Change Rate																								
F5	-30 to +85°C	25°C	Within $\pm \frac{22}{82}\%$																								
10	Adhesive Strength of Termination	<p>No removal of the terminations or other defects shall occur.</p>  <p style="text-align: center;">Fig.1</p>	<p>Solder the capacitor on the testing jig (glass epoxy board) shown in Fig.1 using a eutectic solder. Then apply 5N force in parallel with the test jig for 10 ± 1 sec. The soldering shall be done either with an iron or using the reflow method and shall be conducted with care so that the soldering is uniform and free of defect such as heat shock.</p> <table border="1" style="margin-left: auto; margin-right: auto;"> <thead> <tr> <th>Type</th> <th>a</th> <th>b</th> <th>c</th> </tr> </thead> <tbody> <tr> <td>GJ218</td> <td>1.0</td> <td>3.0</td> <td>1.2</td> </tr> <tr> <td>GJ221</td> <td>1.2</td> <td>4.0</td> <td>1.65</td> </tr> <tr> <td>GJ231</td> <td>2.2</td> <td>5.0</td> <td>2.0</td> </tr> <tr> <td>GJ232</td> <td>2.2</td> <td>5.0</td> <td>2.9</td> </tr> <tr> <td>GJ243</td> <td>3.5</td> <td>7.0</td> <td>3.7</td> </tr> </tbody> </table> <p style="text-align: right;">(in mm)</p>	Type	a	b	c	GJ218	1.0	3.0	1.2	GJ221	1.2	4.0	1.65	GJ231	2.2	5.0	2.0	GJ232	2.2	5.0	2.9	GJ243	3.5	7.0	3.7
Type	a	b	c																								
GJ218	1.0	3.0	1.2																								
GJ221	1.2	4.0	1.65																								
GJ231	2.2	5.0	2.0																								
GJ232	2.2	5.0	2.9																								
GJ243	3.5	7.0	3.7																								
11	Vibration Resistance	<table border="1" style="margin-left: auto; margin-right: auto;"> <thead> <tr> <th>Item</th> <th>Frequency</th> </tr> </thead> <tbody> <tr> <td>Appearance</td> <td>No defects or abnormalities.</td> </tr> <tr> <td>Capacitance Change</td> <td>Within the specified tolerance.</td> </tr> <tr> <td>D.F.</td> <td>50, 100V 10, 16, 25V 6.3V 0.07 max. 0.09 max. 0.15 max.</td> </tr> <tr> <td>Dielectric Strength</td> <td>No failure</td> </tr> </tbody> </table>	Item	Frequency	Appearance	No defects or abnormalities.	Capacitance Change	Within the specified tolerance.	D.F.	50, 100V 10, 16, 25V 6.3V 0.07 max. 0.09 max. 0.15 max.	Dielectric Strength	No failure	<p>Solder the capacitor on the testing jig (glass epoxy board) in the same manner and under the same conditions as (10). The capacitor shall be subjected to simple harmonic motion having a total amplitude of 1.5mm, the frequency being varied uniformly between the approximate limits of 10 and 55Hz. The frequency range, from 10 to 55Hz and return to 10Hz, shall be traversed in approximately 1 minute. This motion shall be applied for a period of 2 hours in each 3 mutually perpendicular directions (total of 6 hours).</p>														
Item	Frequency																										
Appearance	No defects or abnormalities.																										
Capacitance Change	Within the specified tolerance.																										
D.F.	50, 100V 10, 16, 25V 6.3V 0.07 max. 0.09 max. 0.15 max.																										
Dielectric Strength	No failure																										

Continued on the following page.

6

Specifications and Test Methods

Continued from the preceding page.

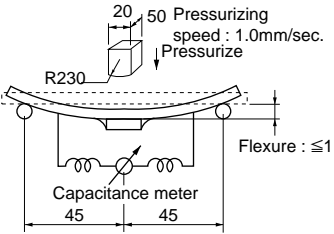
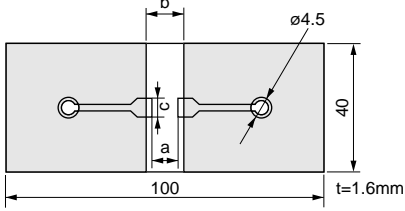
No.	Item	Specification	Test Method																											
12	Deflection	<p>No cracks or marking defects shall occur.</p>  <p style="text-align: center;">Fig.3</p>	<p>Solder the capacitor to the test jig (glass epoxy boards) shown in Fig.2 using a eutectic solder. Then apply a force in the direction shown in Fig.3 for 5±1 sec. The soldering shall be done either with an iron or using the reflow method and shall be conducted with care so that the soldering is uniform and free of defects such as heat shock.</p>  <p style="text-align: center;">Fig.2</p> <table border="1" style="margin-left: auto; margin-right: auto;"> <thead> <tr> <th>Type</th> <th>a</th> <th>b</th> <th>c</th> </tr> </thead> <tbody> <tr> <td>GJ218</td> <td>1.0</td> <td>3.0</td> <td>1.2</td> </tr> <tr> <td>GJ221</td> <td>1.2</td> <td>4.0</td> <td>1.65</td> </tr> <tr> <td>GJ231</td> <td>2.2</td> <td>5.0</td> <td>2.0</td> </tr> <tr> <td>GJ232</td> <td>2.2</td> <td>5.0</td> <td>2.9</td> </tr> <tr> <td>GJ243</td> <td>3.5</td> <td>7.0</td> <td>3.7</td> </tr> </tbody> </table> <p style="text-align: right;">(in mm)</p>	Type	a	b	c	GJ218	1.0	3.0	1.2	GJ221	1.2	4.0	1.65	GJ231	2.2	5.0	2.0	GJ232	2.2	5.0	2.9	GJ243	3.5	7.0	3.7			
Type	a	b	c																											
GJ218	1.0	3.0	1.2																											
GJ221	1.2	4.0	1.65																											
GJ231	2.2	5.0	2.0																											
GJ232	2.2	5.0	2.9																											
GJ243	3.5	7.0	3.7																											
13	Solderability of Termination	75% of the terminations is to be soldered evenly and continuously.	Immerse the capacitor first ethanol (JIS-K-8101) a solution of rosin (JIS-K-5902) (25% rosin in weight proportion), then in an eutectic solder solution for 2±0.5 seconds at 230±5°C after pre-heating in the following table. then set it for 48±4 hours at room temperature and measure.																											
14	Resistance to Soldering Heat	<p>The measured values shall satisfy the values in the following table.</p> <table border="1" style="width: 100%;"> <thead> <tr> <th>Item</th> <th>Specification</th> </tr> </thead> <tbody> <tr> <td>Appearance</td> <td>No marked defect</td> </tr> <tr> <td>Capacitance Change</td> <td>Within ±20%</td> </tr> <tr> <td>I. R.</td> <td>More than 10,000MΩ or 500Ω · F (Whichever is smaller)</td> </tr> <tr> <td>D.F.</td> <td>50, 100V 10, 16, 25V 6.3V 0.07 max. 0.09 max. 0.15 max.</td> </tr> <tr> <td>Dielectric Strength</td> <td>No failure</td> </tr> </tbody> </table>	Item	Specification	Appearance	No marked defect	Capacitance Change	Within ±20%	I. R.	More than 10,000MΩ or 500Ω · F (Whichever is smaller)	D.F.	50, 100V 10, 16, 25V 6.3V 0.07 max. 0.09 max. 0.15 max.	Dielectric Strength	No failure	<p>The capacitor shall be set for 48±4 hours at room temperature after one hour heat of treatment at 150⁺⁰₋₁₀ °C. Immerse the capacitor in a eutectic solder solution at 270±5°C for 10±0.5 seconds after preheating in the following table. Then set it for 48T4 hours at room temperature and measure.</p>															
Item	Specification																													
Appearance	No marked defect																													
Capacitance Change	Within ±20%																													
I. R.	More than 10,000MΩ or 500Ω · F (Whichever is smaller)																													
D.F.	50, 100V 10, 16, 25V 6.3V 0.07 max. 0.09 max. 0.15 max.																													
Dielectric Strength	No failure																													
15	Temperature Cycle	<p>No marking defects.</p> <table border="1" style="width: 100%;"> <thead> <tr> <th>Item</th> <th>Specification</th> </tr> </thead> <tbody> <tr> <td>Appearance</td> <td>No marked defect</td> </tr> <tr> <td>Capacitance Change</td> <td>Within ±20%</td> </tr> <tr> <td>I. R.</td> <td>More than 10,000MΩ or 500Ω · F (Whichever is smaller)</td> </tr> <tr> <td>D.F.</td> <td>50, 100V 10, 16, 25V 6.3V 0.07 max. 0.09 max. 0.15 max.</td> </tr> <tr> <td>Dielectric Strength</td> <td>No failure</td> </tr> </tbody> </table>	Item	Specification	Appearance	No marked defect	Capacitance Change	Within ±20%	I. R.	More than 10,000MΩ or 500Ω · F (Whichever is smaller)	D.F.	50, 100V 10, 16, 25V 6.3V 0.07 max. 0.09 max. 0.15 max.	Dielectric Strength	No failure	<p>The capacitor shall be set for 48±4 hours at room temperature after one hour heat of treatment at 150⁺⁰₋₁₀ °C. Then measure for the initial measurement. Fix capacitor to the supporting jig in the same manner and under the same conditions as in (10) and conduct the five cycles according to the temperature and time shown in the following table. Set it for 48±4 hours at room temperature, then measure.</p> <table border="1" style="margin-left: auto; margin-right: auto;"> <thead> <tr> <th>Step</th> <th>1</th> <th>2</th> <th>3</th> <th>4</th> </tr> </thead> <tbody> <tr> <td>Temp. (°C)</td> <td>Min. Operating Temp. ⁺³₋₃</td> <td>Room Temp.</td> <td>Max. Operating Temp. ⁺³₋₃</td> <td>Room Temp.</td> </tr> <tr> <td>Time (min.)</td> <td>30±3</td> <td>2 to 3</td> <td>30±3</td> <td>2 to 3</td> </tr> </tbody> </table>	Step	1	2	3	4	Temp. (°C)	Min. Operating Temp. ⁺³ ₋₃	Room Temp.	Max. Operating Temp. ⁺³ ₋₃	Room Temp.	Time (min.)	30±3	2 to 3	30±3	2 to 3
Item	Specification																													
Appearance	No marked defect																													
Capacitance Change	Within ±20%																													
I. R.	More than 10,000MΩ or 500Ω · F (Whichever is smaller)																													
D.F.	50, 100V 10, 16, 25V 6.3V 0.07 max. 0.09 max. 0.15 max.																													
Dielectric Strength	No failure																													
Step	1	2	3	4																										
Temp. (°C)	Min. Operating Temp. ⁺³ ₋₃	Room Temp.	Max. Operating Temp. ⁺³ ₋₃	Room Temp.																										
Time (min.)	30±3	2 to 3	30±3	2 to 3																										
16	Humidity Steady State	<p>No marking defects.</p> <table border="1" style="width: 100%;"> <thead> <tr> <th>Item</th> <th>Specification</th> </tr> </thead> <tbody> <tr> <td>Appearance</td> <td>No marked defect</td> </tr> <tr> <td>Capacitance Change</td> <td>Within ±30%</td> </tr> <tr> <td>I. R.</td> <td>More than 1,000MΩ or 50Ω · F (Whichever is smaller)</td> </tr> <tr> <td>D.F.</td> <td>50, 100V 10, 16, 25V 6.3V 0.1 max. 0.125 max. 0.2 max.</td> </tr> <tr> <td>Dielectric Strength</td> <td>No failure</td> </tr> </tbody> </table>	Item	Specification	Appearance	No marked defect	Capacitance Change	Within ±30%	I. R.	More than 1,000MΩ or 50Ω · F (Whichever is smaller)	D.F.	50, 100V 10, 16, 25V 6.3V 0.1 max. 0.125 max. 0.2 max.	Dielectric Strength	No failure	Set the capacitor for 500±12 hours at 40±2°C and 90 to 95% humidity. Take it out and set it for 48T4 hours at room temperature, then measure.															
Item	Specification																													
Appearance	No marked defect																													
Capacitance Change	Within ±30%																													
I. R.	More than 1,000MΩ or 50Ω · F (Whichever is smaller)																													
D.F.	50, 100V 10, 16, 25V 6.3V 0.1 max. 0.125 max. 0.2 max.																													
Dielectric Strength	No failure																													
17	Humidity Load	<p>No marking defects.</p> <table border="1" style="width: 100%;"> <thead> <tr> <th>Item</th> <th>Specification</th> </tr> </thead> <tbody> <tr> <td>Appearance</td> <td>No marked defect</td> </tr> <tr> <td>Capacitance Change</td> <td>Within ±30%</td> </tr> <tr> <td>I. R.</td> <td>More than 500MΩ or 25Ω · F (Whichever is smaller)</td> </tr> <tr> <td>D.F.</td> <td>50, 100V 10, 16, 25V 6.3V 0.1 max. 0.125 max. 0.2 max.</td> </tr> <tr> <td>Dielectric Strength</td> <td>No failure</td> </tr> </tbody> </table>	Item	Specification	Appearance	No marked defect	Capacitance Change	Within ±30%	I. R.	More than 500MΩ or 25Ω · F (Whichever is smaller)	D.F.	50, 100V 10, 16, 25V 6.3V 0.1 max. 0.125 max. 0.2 max.	Dielectric Strength	No failure	Apply the rated voltage for 500±12 hours at 40±2°C and 90 to 95% humidity and set it for 48±4 hours at room temperature, then measure. The charge/discharge current is less than 50mA.															
Item	Specification																													
Appearance	No marked defect																													
Capacitance Change	Within ±30%																													
I. R.	More than 500MΩ or 25Ω · F (Whichever is smaller)																													
D.F.	50, 100V 10, 16, 25V 6.3V 0.1 max. 0.125 max. 0.2 max.																													
Dielectric Strength	No failure																													

Continued on the following page.

Specifications and Test Methods

 Continued from the preceding page.

No.	Item	Specification	Test Method							
18	High Temperature Load	No marked defect.		The voltage treatment shall be given to the capacitor, in which a DC voltage of 200%* the rated voltage is applied for one hour at the maximum operating temperature $\pm 3^{\circ}\text{C}$ then it shall be set for 48 ± 4 hours at room temperature and the measurement shall be conducted. Then apply the above mentioned voltage continuously for 1000 ± 12 hours at the same temperature, remove it from the bath, and set it for 48 ± 4 hours at room temperature, then measure. The charge/discharge current is less than 50mA. *150% for $C > 10\mu\text{F}$						
		<u>Item</u>	<u>Specification</u>							
		Appearance	No marked defect							
		Capacitance Change	Within $\pm 30\%$							
		I. R.	More than $1,000\text{M}\Omega$ or $50\Omega \cdot \text{F}$ (Whichever is smaller)							
		D.F.	<table style="border-collapse: collapse; width: 100%;"> <tr> <td style="border: none;">50, 100V</td> <td style="border: none;">10, 16, 25V</td> <td style="border: none;">6.3V</td> </tr> <tr> <td style="border: none;">0.1 max.</td> <td style="border: none;">0.125 max.</td> <td style="border: none;">0.2 max.</td> </tr> </table>		50, 100V	10, 16, 25V	6.3V	0.1 max.	0.125 max.	0.2 max.
		50, 100V	10, 16, 25V		6.3V					
0.1 max.	0.125 max.	0.2 max.								
Dielectric Strength	No failure									

Characteristics Data

■ Capacitance-Temperature Characteristics

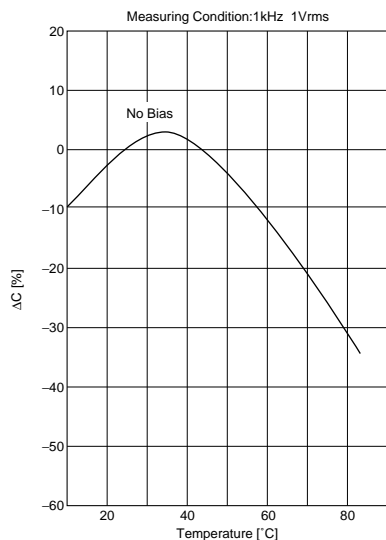

■ Capacitance-DC Voltage Characteristics

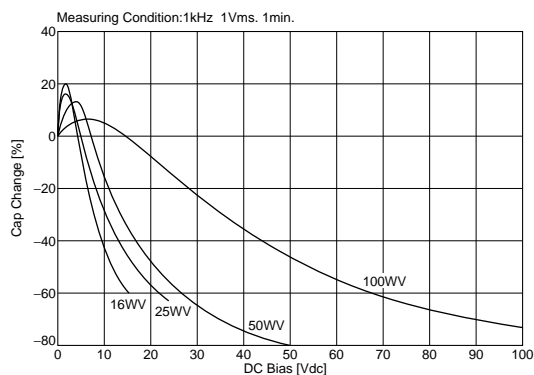

6

■ Capacitance-AC Voltage Characteristics

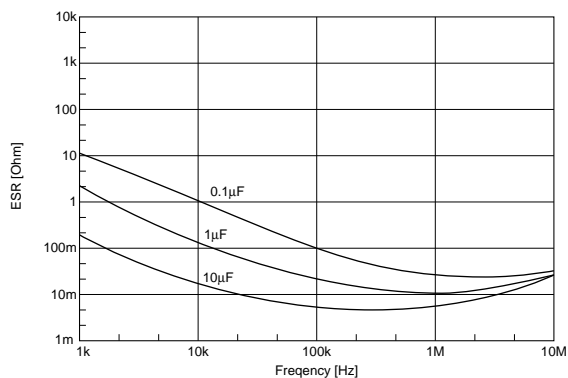

■ Impedance-Frequency Characteristics

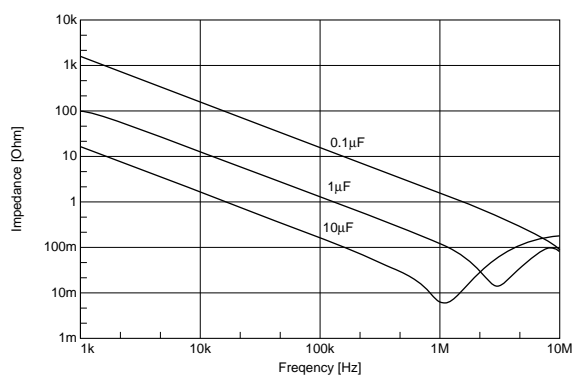

Reference Data

■ Allowable Ripple Current

Ripple current should be less than "Allowable ripple current value" shown in the following table.

And temperature rise of the chip surface (ΔT) should be below 20°C. When AC and DC voltage are superimposed, keep the peak value of the voltage within the rated voltage.

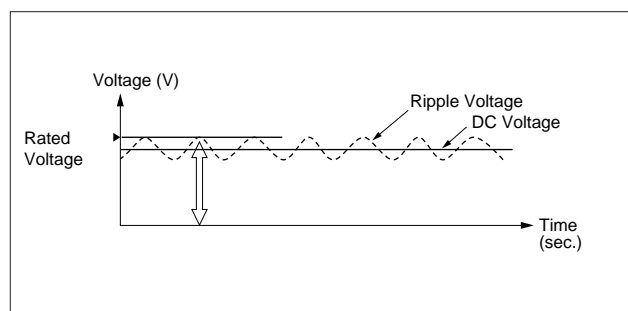

Allowable ripple current value

Series	Rated Voltage	Allowable ripple current value (r.m.s.)		
		100kHz ≤ f < 300kHz	300kHz ≤ f < 500kHz	500kHz ≤ f < 1MHz
GJ221	4V / 6.3V	1.4Ar.m.s.	1.5Ar.m.s.	1.6Ar.m.s.
GJ231		1.5Ar.m.s.	1.6Ar.m.s.	1.6Ar.m.s.
GJ232		1.7Ar.m.s.	1.8Ar.m.s.	2.0Ar.m.s.
GJ243		1.4Ar.m.s.	1.3Ar.m.s.	1.2Ar.m.s.
GJ218	10V	1.4Ar.m.s.	1.5Ar.m.s.	1.6Ar.m.s.
GJ231		1.5Ar.m.s.	1.6Ar.m.s.	1.6Ar.m.s.
GJ232		1.7Ar.m.s.	1.8Ar.m.s.	2.0Ar.m.s.
GJ243		1.4Ar.m.s.	1.3Ar.m.s.	1.2Ar.m.s.
GJ231	16V	1.5Ar.m.s.	1.6Ar.m.s.	1.6Ar.m.s.
GJ232		1.7Ar.m.s.	1.8Ar.m.s.	2.0Ar.m.s.
GJ232	25V / 35V / 50V	2.0Ar.m.s.	2.2Ar.m.s.	2.2Ar.m.s.
GJ243		2.0Ar.m.s.	2.2Ar.m.s.	2.2Ar.m.s.
GJ232	100V	1.6Ar.m.s.	1.7Ar.m.s.	1.8Ar.m.s.

Chip Monolithic Ceramic Capacitors



Microchip

■ Features

1. Better micro wave characteristics.
2. Suitable for by-passing.
3. High density mounting.

■ Applications

- Optical device for telecommunication.
- IC, IC packaging built-in.
- Measuring equipment.

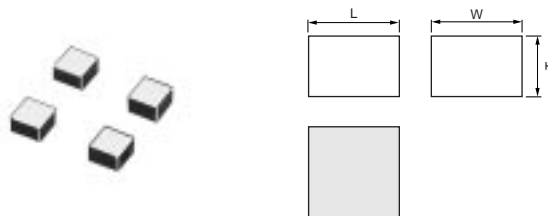

Part Number	Dimensions (mm)		
	L	W	T
GMA05X	0.5 ±0.05	0.5 ±0.05	0.35 ±0.05
GMA085	0.8 ±0.05	0.8 ±0.05	0.5 ±0.1

Part Number	TC	Rated Voltage (Vdc)	Capacitance	Length L (mm)	Width W (mm)	Thickness T (mm)
GMA05XF51A153ZD01	Y5V	10	15000pF +80/-20%	0.5	0.5	0.35
GMA085F51A104ZD01	Y5V	10	0.1μF +80/-20%	0.8	0.8	0.5
GMA05XR71C102MD01	X7R	16	1000pF ±20%	0.5	0.5	0.35
GMA05XR71C152MD01	X7R	16	1500pF ±20%	0.5	0.5	0.35
GMA05XR71C222MD01	X7R	16	2200pF ±20%	0.5	0.5	0.35
GMA085R71C103MD01	X7R	16	10000pF ±20%	0.8	0.8	0.5
GMA05XF51C472ZD01	Y5V	16	4700pF +80/-20%	0.5	0.5	0.35
GMA05XF51C682ZD01	Y5V	16	6800pF +80/-20%	0.5	0.5	0.35
GMA085F51C473ZD01	Y5V	16	47000pF +80/-20%	0.8	0.8	0.5
GMA05XR71H471MD01	X7R	50	470pF ±20%	0.5	0.5	0.35

Specifications and Test Methods

No.	Item	Specification	Test Method												
1	Operating Temperature	R7 : -55°C to +125°C F5 : -30°C to +85°C													
2	Rated Voltage	See the previous pages.	The rated voltage is defined as the maximum voltage which may be applied continuously to the capacitor. When AC voltage is superimposed on DC voltage, V^{P-P} or V^{O-P} , whichever is larger, shall be maintained within the rated voltage range.												
3	Appearance	No defects or abnormalities.	Visual inspection.												
4	Dimensions	See the previous pages.	Visual inspection.												
5	Dielectric Strength	No defects or abnormalities.	No failure shall be observed when a voltage of 250% of the rated voltage is applied between the both terminations for 1 to 5 seconds, provided the charge/discharge current is less than 50mA.												
6	Insulation Resistance (I.R.)	10,000MΩ min.	The insulation resistance shall be measured with a DC voltage not exceeding the rated voltage at normal temperature and humidity and within 2 minutes of charging.												
7	Capacitance	Within the specified tolerance.	The capacitance shall be measured at 25°C with 1±0.1kHz in frequency and 1±0.2Vr.m.s. in voltage.												
8	Dissipation Factor (D.F.)	R7 : 0.035 max. F5 : 0.09 max. (for 16V) : 0.125 max. (for 10V)	D.F. shall be measured under the same conditions at the capacitance.												
9	Capacitance Temperature Characteristics	<table border="1" style="width: 100%; border-collapse: collapse; margin-bottom: 5px;"> <thead> <tr> <th>Char.</th> <th>Temp. Range</th> <th>Reference Temp.</th> <th>Cap. Change Rate</th> </tr> </thead> <tbody> <tr> <td>R7</td> <td>-55 to +125°C</td> <td>25°C</td> <td>Within±15%</td> </tr> <tr> <td>F5</td> <td>-30 to +85°C</td> <td>25°C</td> <td>Within±22%</td> </tr> </tbody> </table>	Char.	Temp. Range	Reference Temp.	Cap. Change Rate	R7	-55 to +125°C	25°C	Within±15%	F5	-30 to +85°C	25°C	Within±22%	The range of capacitance change in reference to 25°C within the temperature range shown in the table shall be within the specified ranges. The capacitance change shall be measured after 5 min. at each specified temperature stage.
Char.	Temp. Range	Reference Temp.	Cap. Change Rate												
R7	-55 to +125°C	25°C	Within±15%												
F5	-30 to +85°C	25°C	Within±22%												
10	Mechanical Strength	Bond Strength	MIL-STD-883 Method 2011 Condition D Mount the capacitor on a gold metallized alumina substrate with Au-Sn (80/20) and bond a 20μm (0.0008 inch) gold wire to the capacitor terminal using an ultrasonic wedge bond. Then, pull wire.												
		Die Shear Strength		MIL-STD-883 Method 2019 Mount the capacitor on a gold metallized alumina substrate with Au-Sn (80/20). Apply the force parallel to the substrate.											
11	Vibration Resistance	Appearance	Ramp frequency from 10 to 55Hz then return to 10Hz all within 1 minute. Amplitude : 1.5 mm (0.06 inch) max. total excursion. Apply this motion for a period of 2 hours in each of 3 mutually perpendicular directions (total 6 hours).												
		Capacitance													
		D.F.													
12	Temperature Cycle	The measured values shall satisfy the values in the following table.													
		Item	Specification												
		Appearance	No marked defect												
		Capacitance Change	R7 Within±7.5% F5 Within±20%												
		I.R.	More than 10,000MΩ												
		D.F.	R7 0.035 max. F5 0.09 max.(for 16V) 0.125 max.(for 10V)												
		Step	1	2	3	4									
		Temp.(°C)	Min. Operating Temp. ± 3	Room Temp.	Max. Operating Temp. ± 3	Room Temp.									
		Time(min.)	30±3	2 to 3	30±3	2 to 3									
13	Humidity (Steady State)	The measured values shall satisfy the values in the following table.													
		Item	Specification												
		Appearance	No marked defect												
		Capacitance Change	R7 Within±12.5% F5 Within±30%												
		I.R.	More than 1,000MΩ												
		D.F.	R7 0.05 max. F5 0.125 max.(for 16V) 0.15 max.(for 10V)												
		Set the capacitor for 500±12 hours at 40±20°C, in 90 to 95% humidity. Take it out and set it for 48±4 hours at room temperature, then measure.													

Continued on the following page.

Specifications and Test Methods

Continued from the preceding page.

No.	Item	Specification	Test Method												
14	Humidity Load	<p>The measured values shall satisfy the values in the following table.</p> <table border="1" style="width: 100%; border-collapse: collapse; margin-bottom: 10px;"> <thead> <tr style="background-color: #f2f2f2;"> <th style="width: 30%;">Item</th> <th style="width: 70%;">Specification</th> </tr> </thead> <tbody> <tr> <td>Appearance</td> <td>No marked defect</td> </tr> <tr> <td>Capacitance Change</td> <td>R7 Within±12.5% F5 Within±3.0%</td> </tr> <tr> <td>I.R.</td> <td>More than 500MΩ</td> </tr> <tr> <td>D.F.</td> <td>R7 0.05 max. F5 0.125 max.(for 16V) 0.15 max.(for 10V)</td> </tr> <tr> <td>Dielectric Strength</td> <td>No failure</td> </tr> </tbody> </table>	Item	Specification	Appearance	No marked defect	Capacitance Change	R7 Within±12.5% F5 Within±3.0%	I.R.	More than 500MΩ	D.F.	R7 0.05 max. F5 0.125 max.(for 16V) 0.15 max.(for 10V)	Dielectric Strength	No failure	<p>Apply the rated voltage for 500±12 hours at 40±20°C, in 90 to 95% humidity and set it for 48±4 hours at room temperature, then measure. The charge/discharge current is less than 50mA.</p> <ul style="list-style-type: none"> • Initial measurement for Y5V <p>Perform a heat treatment at 150 ± 5 °C for one hour and then let sit for 48±4 hours at room temperature. Perform the initial measurement.</p>
Item	Specification														
Appearance	No marked defect														
Capacitance Change	R7 Within±12.5% F5 Within±3.0%														
I.R.	More than 500MΩ														
D.F.	R7 0.05 max. F5 0.125 max.(for 16V) 0.15 max.(for 10V)														
Dielectric Strength	No failure														
15	High Temperature Load	<p>The measured values shall satisfy the values in the following table.</p> <table border="1" style="width: 100%; border-collapse: collapse; margin-bottom: 10px;"> <thead> <tr style="background-color: #f2f2f2;"> <th style="width: 30%;">Item</th> <th style="width: 70%;">Specification</th> </tr> </thead> <tbody> <tr> <td>Appearance</td> <td>No marked defect</td> </tr> <tr> <td>Capacitance Change</td> <td>R7 Within±12.5% F5 Within±3.0%</td> </tr> <tr> <td>I.R.</td> <td>More than 1,000MΩ</td> </tr> <tr> <td>D.F.</td> <td>R7 0.05 max. F5 0.125 max.(for 16V) 0.15 max.(for 10V)</td> </tr> <tr> <td>Dielectric Strength</td> <td>No failure</td> </tr> </tbody> </table>	Item	Specification	Appearance	No marked defect	Capacitance Change	R7 Within±12.5% F5 Within±3.0%	I.R.	More than 1,000MΩ	D.F.	R7 0.05 max. F5 0.125 max.(for 16V) 0.15 max.(for 10V)	Dielectric Strength	No failure	<p>A voltage treatment shall be given to the capacitor, in which a DC voltage of 200% the rated voltage is applied for one hour at the maximum operating temperature ±3°C then it shall be set for 48±4 hours at room temperature and the initial measurement shall be conducted.</p> <p>Then apply the above mentioned voltage continuously for 1000±12 hours at the same temperature, remove it from the bath, and set it for 48±4 hours at room temperature, then measure. The charge/discharge current is less than 50mA.</p>
Item	Specification														
Appearance	No marked defect														
Capacitance Change	R7 Within±12.5% F5 Within±3.0%														
I.R.	More than 1,000MΩ														
D.F.	R7 0.05 max. F5 0.125 max.(for 16V) 0.15 max.(for 10V)														
Dielectric Strength	No failure														

Mounting for testing : The capacitors shall be mounted on the substrate as shown below using die bonding and wire bonding when tests No. 11 to 15 are performed.

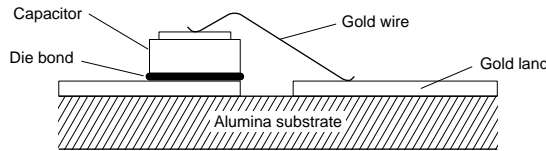
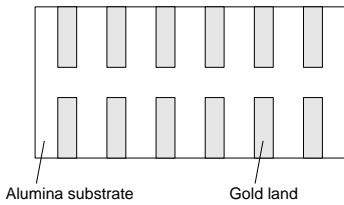

7

Chip Monolithic Ceramic Capacitors



Capacitor Array

■ Features

1. High density mounting due to mounting space saving.
2. Mounting cost saving.

■ Applications

eneral electronic equipment

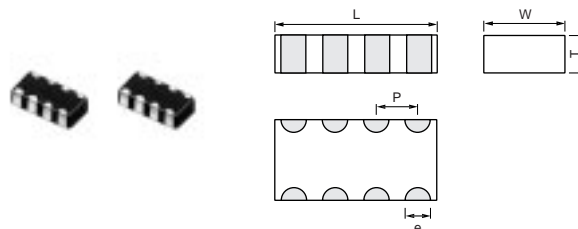

Part Number	Dimensions (mm)				
	L	W	T	P	e
GNM314	3.2 ±0.15	1.6 ±0.15	0.8 ±0.1 1.0 ±0.1	0.8 ±0.1	0.4 ±0.15

Temperature Compensating Type

Part Number	GNM31	
L x W	3.2x1.6	
TC	COG (5C)	
Rated Volt.	50 (1H)	100 (2A)
Capacitance and T Dimension		
10pF(100)	0.8(4)	0.8(4)
11pF(110)	0.8(4)	0.8(4)
12pF(120)	0.8(4)	0.8(4)
13pF(130)	0.8(4)	0.8(4)
15pF(150)	0.8(4)	0.8(4)
16pF(160)	0.8(4)	0.8(4)
18pF(180)	0.8(4)	0.8(4)
20pF(200)	0.8(4)	0.8(4)
22pF(220)	0.8(4)	0.8(4)
24pF(240)	0.8(4)	0.8(4)
27pF(270)	0.8(4)	0.8(4)
30pF(300)	0.8(4)	0.8(4)
33pF(330)	0.8(4)	0.8(4)
36pF(360)	0.8(4)	0.8(4)
39pF(390)	0.8(4)	0.8(4)
43pF(430)	0.8(4)	0.8(4)
47pF(470)	0.8(4)	0.8(4)
51pF(510)	0.8(4)	0.8(4)
56pF(560)	0.8(4)	0.8(4)
62pF(620)	0.8(4)	0.8(4)
68pF(680)	0.8(4)	0.8(4)
75pF(750)	0.8(4)	0.8(4)
82pF(820)	0.8(4)	0.8(4)
91pF(910)	0.8(4)	0.8(4)
100pF(101)	0.8(4)	0.8(4)
110pF(111)	0.8(4)	0.8(4)
120pF(121)	0.8(4)	0.8(4)
130pF(131)	0.8(4)	0.8(4)
150pF(151)	0.8(4)	0.8(4)
160pF(161)	0.8(4)	0.8(4)
180pF(181)	0.8(4)	0.8(4)

Continued on the following page.

 Continued from the preceding page.

Part Number	GNM31	
L x W	3.2x1.6	
TC	COG (5C)	
Rated Volt.	50 (1H)	100 (2A)
Capacitance and T Dimension		
200pF(201)	0.8(4)	
220pF(221)	0.8(4)	
240pF(241)	0.8(4)	
270pF(271)	0.8(4)	
300pF(301)	0.8(4)	
330pF(331)	0.8(4)	
360pF(361)	0.8(4)	

The part numbering code is shown in each (). The (4) code in T(mm) means number of elements (four).
Dimensions are shown in mm and Rated Voltage in Vdc.

High Dielectric Constant Type

Part Number	GNM31						
L x W	3.2x1.6						
TC	X7R (R7)				Y5V (F5)		
Rated Volt.	16 (1C)	25 (1E)	50 (1H)	100 (2A)	16 (1C)	50 (1H)	100 (2A)
Capacitance and T Dimension							
220pF(221)				0.8(4)			
270pF(271)				0.8(4)			
330pF(331)				0.8(4)			
390pF(391)			0.8(4)	0.8(4)			
470pF(471)			0.8(4)	0.8(4)			
560pF(561)			0.8(4)	0.8(4)			
680pF(681)			0.8(4)	0.8(4)			
820pF(821)			0.8(4)	0.8(4)			
1000pF(102)			0.8(4)	0.8(4)			
1200pF(122)			0.8(4)	0.8(4)			
1500pF(152)			0.8(4)	0.8(4)			
1800pF(182)			0.8(4)	0.8(4)			
2200pF(222)			0.8(4)	0.8(4)			0.8(4)
2700pF(272)			0.8(4)	0.8(4)			
3300pF(332)			0.8(4)	0.8(4)			0.8(4)
3900pF(392)			0.8(4)	0.8(4)			
4700pF(472)			0.8(4)	0.8(4)			0.8(4)
5600pF(562)			0.8(4)				
6800pF(682)			0.8(4)				
8200pF(822)			0.8(4)				
10000pF(103)			0.8(4)				
12000pF(123)			0.8(4)				
15000pF(153)			0.8(4)				
18000pF(183)		0.8(4)					
22000pF(223)	0.8(4)					0.8(4)	
27000pF(273)	0.8(4)						
33000pF(333)	0.8(4)					0.8(4)	
39000pF(393)	0.8(4)						
47000pF(473)	1.0(4)					0.8(4)	
68000pF(683)	1.0(4)				0.8(4)		
100000pF(104)	1.0(4)				0.8(4)		
150000pF(154)					0.8(4)		

The part numbering code is shown in each (). The (4) code in T(mm) means number of elements (four).
Dimensions are shown in mm and Rated Voltage in Vdc.

Specifications and Test Methods

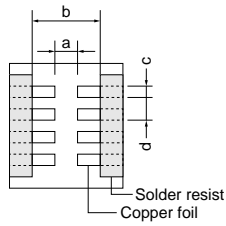
No.	Item	Specification		Test Method																								
		Temperature Compensating Type	High Dielectric Constant Type																									
1	Operating Temperature	5C : -55 to +125°C	R7 : -55 to +125°C F5 : -30 to +85°C																									
2	Rated Voltage	See the previous page.		The rated voltage is defined as the maximum voltage which may be applied continuously to the capacitor. When AC voltage is superimposed on DC voltage, V^{P-P} or V^{O-P} , whichever is larger, shall be maintained within the rated voltage range.																								
3	Appearance	No defects or abnormalities.		Visual inspection.																								
4	Dimensions	Within the specified dimension.		Using calipers.																								
5	Dielectric Strength	No defects or abnormalities.		No failure shall be observed when 300% of the rated voltage (C0G) or 250% of the rated voltage (X7R and Y5V) is applied between the terminations for 1 to 5 seconds, provided the charge/discharge current is less than 50mA.																								
6	Insulation Resistance (I.R.)	More than 10,000MΩ or 500Ω • F (Whichever is smaller)		The insulation resistance shall be measured with a DC voltage not exceeding the rated voltage at 25°C and 75%RH max. and within 2 minutes of charging.																								
7	Capacitance	Within the specified tolerance.		The capacitance/Q/D.F. shall be measured at 25°C at the frequency and voltage shown in the table.																								
8	Q/Dissipation Factor (D.F.)	30pF min. : $Q \geq 1,000$ 30pF max. : $Q \geq 400+20C$ C : Nominal Capacitance (pF)	<table border="1" style="font-size: small;"> <tr> <th>Char.</th> <th>25V min.</th> <th>16V</th> </tr> <tr> <td>R7</td> <td>0.025 max.</td> <td>0.035 max.</td> </tr> <tr> <td>F5</td> <td>0.05 max.</td> <td>0.07 max.</td> </tr> </table>	Char.	25V min.	16V	R7	0.025 max.	0.035 max.	F5	0.05 max.	0.07 max.	<table border="1" style="font-size: small;"> <tr> <th>Item \ Char.</th> <th>5C</th> <th>R7, F5</th> </tr> <tr> <td>Frequency</td> <td>1±0.1MHz</td> <td>1±0.1MHz</td> </tr> <tr> <td>Voltage</td> <td>0.5 to 5Vr.m.s.</td> <td>1±0.2Vr.m.s.</td> </tr> </table>	Item \ Char.	5C	R7, F5	Frequency	1±0.1MHz	1±0.1MHz	Voltage	0.5 to 5Vr.m.s.	1±0.2Vr.m.s.						
			Char.	25V min.	16V																							
R7	0.025 max.	0.035 max.																										
F5	0.05 max.	0.07 max.																										
Item \ Char.	5C	R7, F5																										
Frequency	1±0.1MHz	1±0.1MHz																										
Voltage	0.5 to 5Vr.m.s.	1±0.2Vr.m.s.																										
9	Capacitance Temperature Characteristics	Capacitance Change	Within the specified tolerance. (Table A-5)	<table border="1" style="font-size: small;"> <tr> <th>Char.</th> <th>Temp. Range.</th> <th>Reference Temp.</th> <th>Cap. Change</th> </tr> <tr> <td>R7</td> <td>-55to +125°C</td> <td>25°C</td> <td>Within±15%</td> </tr> <tr> <td>F5</td> <td>-30to +85°C</td> <td></td> <td>Within±22%</td> </tr> </table> <p>The capacitance change shall be measured after 5 min. at each specified temperature stage.</p> <p>(1) Temperature Compensating Type The temperature coefficient is determined using the capacitance measured in step 3 as a reference. When cycling the temperature sequentially from step 1 through 5, the capacitance shall be within the specified tolerance for the temperature coefficient and capacitance change as Table A.</p> <p>The capacitance drift is calculated by dividing the differences between the maximum and minimum measured values in the step 1, 3 and 5 by the cap. value in step 3.</p> <table border="1" style="font-size: small; margin: 5px auto;"> <thead> <tr> <th>Step</th> <th>Temperature(°C)</th> </tr> </thead> <tbody> <tr><td>1</td><td>25±2</td></tr> <tr><td>2</td><td>-55±3</td></tr> <tr><td>3</td><td>25±2</td></tr> <tr><td>4</td><td>125±3</td></tr> <tr><td>5</td><td>25±2</td></tr> </tbody> </table> <p>(2) High Dielectric Constant Type The ranges of capacitance change compared with the 25°C value over the temperature ranges shown in the table shall be within the specified ranges.</p>	Char.	Temp. Range.	Reference Temp.	Cap. Change	R7	-55to +125°C	25°C	Within±15%	F5	-30to +85°C		Within±22%	Step	Temperature(°C)	1	25±2	2	-55±3	3	25±2	4	125±3	5	25±2
		Char.	Temp. Range.		Reference Temp.	Cap. Change																						
		R7	-55to +125°C		25°C	Within±15%																						
F5	-30to +85°C		Within±22%																									
Step	Temperature(°C)																											
1	25±2																											
2	-55±3																											
3	25±2																											
4	125±3																											
5	25±2																											
Temperature Coefficient	Within the specified tolerance. (Table A-5)																											
Capacitance Drift	Within ±0.2% or ±0.05pF (Whichever is larger)																											
10	Adhesive Strength of Termination	No removal of the terminations or other defects shall occur.		<p>Solder the capacitor to the test jig (glass epoxy board) shown in Fig.1 using a eutectic solder. Then apply 5N force in parallel with the test jig for 10±1 sec. The soldering shall be done either with an iron or using the reflow method and shall be conducted with care so that the soldering is uniform and free of defects such as heat shock.</p> <div style="text-align: center;">  </div> <table border="1" style="font-size: small; margin: 10px auto;"> <thead> <tr> <th>Type</th> <th>a</th> <th>b</th> <th>c</th> <th>d</th> </tr> </thead> <tbody> <tr> <td>GNM31</td> <td>0.8</td> <td>2.5</td> <td>0.4</td> <td>0.8</td> </tr> </tbody> </table> <p style="text-align: right;">(in mm)</p> <p style="text-align: center;">Fig.1</p>	Type	a	b	c	d	GNM31	0.8	2.5	0.4	0.8														
Type	a	b	c	d																								
GNM31	0.8	2.5	0.4	0.8																								

Continued on the following page.

Specifications and Test Methods

Continued from the preceding page.

No.	Item	Specification			Test Method															
		Temperature Compensating Type	High Dielectric Constant Type																	
11	Vibration Resistance	Appearance	No defects or abnormalities.			Solder the capacitor to the test jig (glass epoxy board) in the same manner and under the same conditions as (10). The capacitor shall be subjected to a simple harmonic motion having a total amplitude of 1.5mm, the frequency being varied uniformly between the approximate limits of 10 and 55Hz. The frequency range, from 10 to 55Hz and return to 10Hz, shall be traversed in approximately 1 minute. This motion shall be applied for a period of 2 hours in each 3 mutually perpendicular directions (total of 6 hours).														
		Capacitance	Within the specified tolerance.																	
		Q/D.F.	30pF min. : $Q \geq 1000$ 30pF max. : $Q \geq 400+20C$ C : Nominal Capacitance (pF)	Char.	25V min.		16V													
			R7	0.025 max.	0.035 max.															
			F5	0.05 max.	0.07 max.															
12	Deflection	No cracking or marking defects shall occur.			Solder the capacitor to the test jig (glass epoxy boards) shown in Fig.2 using a eutectic solder. Then apply a force in the direction shown in Fig.3. The soldering shall be done either with an iron or using the reflow method and shall be conducted with care so that the soldering is uniform and free of defects such as heat shock.															
13	Solderability of Termination	75% of the terminations is to be soldered evenly and continuously.			Immerse the capacitor in a solution of ethanol (JIS-K-8101) and rosin (JIS-K-5902) (25% rosin in weight proportion). Preheat at 80 to 120°C for 10 to 30 seconds. After preheating, immerse in eutectic solder solution for 2±0.5 seconds at 230±5°C.															
14	Resistance to Soldering Heat	The measured and observed characteristics shall satisfy the specifications in the following table.			Preheat the capacitor at 120 to 150°C for 1 minute. Immerse the capacitor in a eutectic solder solution at 270±5°C for 10±0.5 seconds. Let sit at room temperature for 24±2 hours (temperature compensating type) or 48±4 hours (high dielectric constant type), then measure. • Initial measurement for high dielectric constant type Perform a heat treatment at 150±9.0°C for one hour and then let sit for 48±4 hours at room temperature. Perform the initial measurement.															
		Appearance	No marking defects.																	
		Capacitance Change	Within ±2.5% or ±0.25pF (Whichever is larger)	R7		Within±7.5%														
				F5		Within±20%														
		Q/D.F.	30pF and over : $Q \geq 1,000$ 30pF and below : $Q \geq 400+20C$ C : Nominal Capacitance (pF)	Char.		25V min.	16V													
		R7	0.025 max.	0.035 max.																
		F5	0.05 max.	0.07 max.																
	I.R.	More than 10,000MΩ or 500Ω • F (Whichever is smaller)																		
	Dielectric Strength	No failure																		
15	Temperature Cycle	The measured and observed characteristics shall satisfy the specifications in the following table.			Fix the capacitor to the supporting jig in the same manner and under the same conditions as (10). Perform the five cycles according to the four heat treatments listed in the following table. Let sit for 24±2 hours (temperature compensating type) or 48±4 hours (high dielectric constant type) at room temperature, then measure. <table border="1"> <thead> <tr> <th>Step</th> <th>1</th> <th>2</th> <th>3</th> <th>4</th> </tr> </thead> <tbody> <tr> <td>Temp.(°C)</td> <td>Min. Operating Temp. ± 3</td> <td>Room Temp.</td> <td>Max. Operating Temp. ± 3</td> <td>Room Temp.</td> </tr> <tr> <td>Time(min.)</td> <td>30±3</td> <td>2 to 3</td> <td>30±3</td> <td>2 to 3</td> </tr> </tbody> </table>	Step	1	2	3	4	Temp.(°C)	Min. Operating Temp. ± 3	Room Temp.	Max. Operating Temp. ± 3	Room Temp.	Time(min.)	30±3	2 to 3	30±3	2 to 3
		Step	1	2		3	4													
		Temp.(°C)	Min. Operating Temp. ± 3	Room Temp.		Max. Operating Temp. ± 3	Room Temp.													
		Time(min.)	30±3	2 to 3		30±3	2 to 3													
		Appearance	No marking defects.																	
Capacitance Change	Within ±2.5% or ±0.25pF (Whichever is larger)	R7	Within±7.5%																	
		F5	Within±20%																	
Q/D.F.	30pF and over : $Q \geq 1,000$ 30pF and below : $Q \geq 400+20C$ C : Nominal Capacitance (pF)	Char.	25V min.	16V																
		R7	0.025 max.	0.035 max.																
		F5	0.05 max.	0.07 max.																
	I.R.	More than 10,000MΩ or 500Ω • F (Whichever is smaller)																		
	Dielectric Strength	No failure																		

Continued on the following page.

Specifications and Test Methods

 Continued from the preceding page.

No.	Item	Specification			Test Method										
		Temperature Compensating Type	High Dielectric Constant Type												
16	Humidity, Steady State	The measured and observed characteristics shall satisfy the specifications in the following table.			Sit the capacitor at 40±2°C and 90 to 95% humidity for 500±12 hours. Remove and let sit for 24±2 hours (temperature compensating type) or 48±4 hours (high dielectric constant type) at room temperature, then measure.										
		Appearance	No marking defects.												
		Capacitance Change	Within ±5% or ±0.5pF (Whichever is larger)	R7 Within±12.5%		F5 Within±30%									
		Q/D.F.	30pF and over : Q≥350 10pF and over, 30pF and below : $Q \geq 275 + \frac{5}{3} C$ 10pF and below : $Q \geq 200 + 10C$ C : Nominal Capacitance (pF)	<table border="1" style="width: 100%; border-collapse: collapse;"> <thead> <tr> <th>Char.</th> <th>25V min.</th> <th>16V</th> </tr> </thead> <tbody> <tr> <td>R7</td> <td>0.05 max.</td> <td>0.05 max.</td> </tr> <tr> <td>F5</td> <td>0.075 max.</td> <td>0.1 max.</td> </tr> </tbody> </table>		Char.	25V min.	16V	R7	0.05 max.	0.05 max.	F5	0.075 max.	0.1 max.	
		Char.	25V min.	16V											
R7	0.05 max.	0.05 max.													
F5	0.075 max.	0.1 max.													
I.R.	More than 1,000MΩ or 50Ω • F (Whichever is smaller)														
17	Humidity Load	The measured and observed characteristics shall satisfy the specifications in the following table.			Apply the rated voltage at 40±2°C and 90 to 95% humidity for 500±12 hours. Remove and let sit for 24±2 hours (temperature compensating type) or 48±4 hours (high dielectric constant type) at room temperature, then measure. The charge/discharge current is less than 50mA.										
		Appearance	No marking defects.												
		Capacitance Change	Within ±7.5% or ±0.75pF (Whichever is larger)	R7 Within±12.5%		F5 Within±30%									
		Q/D.F.	30pF and over : Q≥200 30pF and below : $Q \geq 100 + \frac{10}{3} C$ C : Nominal Capacitance (pF)	<table border="1" style="width: 100%; border-collapse: collapse;"> <thead> <tr> <th>Char.</th> <th>25V min.</th> <th>16V</th> </tr> </thead> <tbody> <tr> <td>R7</td> <td>0.05 max.</td> <td>0.05 max.</td> </tr> <tr> <td>F5</td> <td>0.075 max.</td> <td>0.1 max.</td> </tr> </tbody> </table>		Char.	25V min.	16V	R7	0.05 max.	0.05 max.	F5	0.075 max.	0.1 max.	
		Char.	25V min.	16V											
R7	0.05 max.	0.05 max.													
F5	0.075 max.	0.1 max.													
I.R.	More than 500MΩ or 25Ω • F (Whichever is smaller)														
	Dielectric Strength	No failure													
18	High Temperature Load	The measured and observed characteristics shall satisfy the specifications in the following table.			Apply 200% of the rated voltage for 1,000±12 hours at the maximum operating temperature ±3°C. Let sit for 24±2 hours (temperature compensating type) or 48±4 hours (high dielectric constant type) at room temperature, then measure. The charge/discharge current is less than 50mA. •Initial measurement for high dielectric constant type. Apply 200% of the rated DC voltage for one hour at the maximum operating temperature ±3°C. Remove and let sit for 48±4 hours at room temperature. Perform initial measurement.										
		Appearance	No marking defects.												
		Capacitance Change	Within ±3% or ±0.3pF (Whichever is larger)	R7 Within±12.5%		F5 Within±30%									
		Q/D.F.	30pF and over : Q≥350 10pF and over, 30pF and below : $Q \geq 275 + \frac{5}{3} C$ 10pF and below : $Q \geq 200 + 10C$ C : Nominal Capacitance (pF)	<table border="1" style="width: 100%; border-collapse: collapse;"> <thead> <tr> <th>Char.</th> <th>25V min.</th> <th>16V</th> </tr> </thead> <tbody> <tr> <td>R7</td> <td>0.04 max.</td> <td>0.05 max.</td> </tr> <tr> <td>F5</td> <td>0.075 max.</td> <td>0.1 max.</td> </tr> </tbody> </table>		Char.	25V min.	16V	R7	0.04 max.	0.05 max.	F5	0.075 max.	0.1 max.	
		Char.	25V min.	16V											
R7	0.04 max.	0.05 max.													
F5	0.075 max.	0.1 max.													
I.R.	More than 1,000MΩ or 50Ω • F (Whichever is smaller)														
	Dielectric Strength	No failure													

8

Table A

Char. Code	Temp. Coeff. (ppm/°C) Note 1	Capacitance Change from 25°C (%)					
		-55°C		-30°C		-10°C	
		Max.	Min.	Max.	Min.	Max.	Min.
5C	0±30	0.58	-0.24	0.40	-0.17	0.25	-0.11

Note 1 : Nominal values denote the temperature coefficient within a range of 25 to 125°C.

Chip Monolithic Ceramic Capacitors



for Ultrasonic Sensors

■ Features

1. Proper to compensate for ultrasonic sensor.
2. Small chip size and high cap. Value.

■ Application

Ultrasonic sensor
(Back sonar, Corner sonar and etc.)

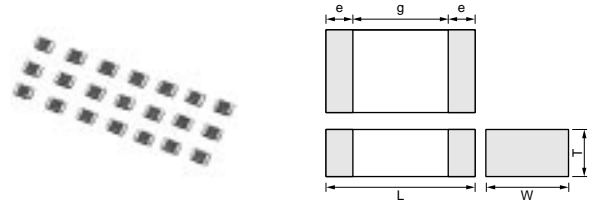

Part Number	Dimensions (mm)				
	L	W	T	e	g min.
GRM219	2.0 ±0.1	1.25 ±0.1	0.85 ±0.1	0.2 to 0.7	0.7

Part Number	TC	Rated Voltage (Vdc)	Capacitance (pF)	Length L (mm)	Width W (mm)	Thickness T (mm)
GRM2199E2A102KD01	ZLM	100	1000 ±10%	2.0	1.25	0.85
GRM2199E2A152KD01	ZLM	100	1500 ±10%	2.0	1.25	0.85

Specifications and Test Methods

No.	Item	Specification	Test Method												
1	Operating Temperature	-25°C to +85°C													
2	Rated Voltage	See the previous pages.	The rated voltage is defined as the maximum voltage which may be applied continuously to the capacitor. When AC voltage is superimposed on DC voltage, V^{P-P} or V^{O-P} , whichever is larger, shall be maintained within the rated voltage range.												
3	Appearance	No defects or abnormalities.	Visual inspection.												
4	Dimensions	Within the specified dimensions.	Using calipers.												
5	Dielectric Strength	No defects or abnormalities.	No failure shall be observed when 300% of the rated voltage is applied between the terminations for 1 to 5 seconds, provided the charge/discharge current is less than 50mA.												
6	Insulation Resistance (I.R.)	More than 10,000MΩ or 500Ω • F. (Whichever is smaller)	The insulation resistance shall be measured with a DC voltage not exceeding the rated voltage at 20°C and 75%RH max. and within 2 minutes of charging.												
7	Capacitance	Within the specified tolerance.	The capacitance/D.F. shall be measured at 20°C with 1±0.1kHz in frequency and 1±0.2Vr.m.s. in voltage.												
8	Dissipation Factor (D.F.)	0.01 max.													
9	Capacitance Temperature Characteristics	Within $-4,700 \pm 1,888$ ppm/°C (at -25 to +20°C) Within $-4,700 \pm 1,000$ ppm/°C (at +20 to +85°C)	<p>The temperature coefficient is determined using the capacitance measured in step 1 as a reference. When cycling the temperature sequentially from step 1 through 5, the capacitance shall be within the specified tolerance for the temperature coefficient. The capacitance change shall be measured after 5 min. at each specified temperature stage.</p> <table border="1" style="margin-left: auto; margin-right: auto;"> <thead> <tr> <th>Step</th> <th>Temperature(°C)</th> </tr> </thead> <tbody> <tr> <td>1</td> <td>20±2</td> </tr> <tr> <td>2</td> <td>-25±3</td> </tr> <tr> <td>3</td> <td>20±2</td> </tr> <tr> <td>4</td> <td>85±3</td> </tr> <tr> <td>5</td> <td>20±2</td> </tr> </tbody> </table>	Step	Temperature(°C)	1	20±2	2	-25±3	3	20±2	4	85±3	5	20±2
Step	Temperature(°C)														
1	20±2														
2	-25±3														
3	20±2														
4	85±3														
5	20±2														
10	Adhesive Strength of Termination	No removal of the terminations or other defect shall occur.	<p>Solder the capacitor to the test jig (glass epoxy board) shown in Fig.1 using a eutectic solder. Then apply 10N force in the direction of the arrow. The soldering shall be done either with an iron or using the reflow method and shall be conducted with care so that the soldering is uniform and free of defects such as heat shock.</p> <div style="text-align: center;"> <p style="text-align: right;">Solder resist Baked electrode or copper foil</p> <table border="1" style="margin-left: auto; margin-right: auto;"> <thead> <tr> <th>Type</th> <th>a</th> <th>b</th> <th>c</th> </tr> </thead> <tbody> <tr> <td>GRM21</td> <td>1.2</td> <td>4.0</td> <td>1.65</td> </tr> </tbody> </table> <p style="text-align: right;">(in mm)</p> </div> <p style="text-align: center;">Fig.1</p>	Type	a	b	c	GRM21	1.2	4.0	1.65				
Type	a	b	c												
GRM21	1.2	4.0	1.65												
11	Vibration Resistance	Appearance	No defects or abnormalities.												
		Capacitance	Within the specified tolerance.												
		D.F.	0.01 max.												
			<p>Solder the capacitor to the test jig (glass epoxy board) in the same manner and under the same conditions as (10). The capacitor shall be subjected to a simple harmonic motion having a total amplitude of 1.5mm, the frequency being varied uniformly between the approximate limits of 10 and 55Hz. The frequency range, from 10 to 55Hz and return to 10Hz, shall be traversed in approximately 1 minute. This motion shall be applied for a period of 2 hours in each 3 mutually perpendicular directions (total of 6 hours).</p>												

Continued on the following page.

Specifications and Test Methods

Continued from the preceding page.

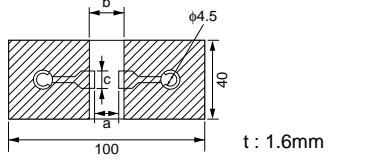
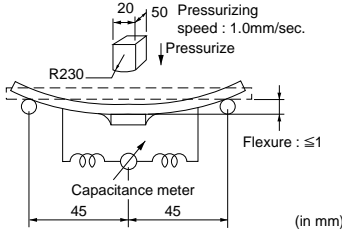
No.	Item	Specification	Test Method					
12	Deflection	No cracking or marking defects shall occur.	<p>Solder the capacitor to the test jig (glass epoxy boards) shown in Fig.2 using a eutectic solder.</p> <p>Then apply a force in the direction shown in Fig.3.</p> <p>The soldering shall be done either with an iron or using the reflow method and shall be conducted with care so that the soldering is uniform and free of defects such as heat shock.</p>					
		 <table border="1" data-bbox="370 622 880 676"> <thead> <tr> <th>Type</th> <th>a</th> <th>b</th> <th>c</th> </tr> </thead> <tbody> <tr> <td>GRM21</td> <td>1.2</td> <td>4.0</td> <td>1.65</td> </tr> </tbody> </table> <p>(in mm)</p> <p>Fig.2</p>		Type	a	b	c	GRM21
Type	a	b	c					
GRM21	1.2	4.0	1.65					
			 <p>(in mm)</p> <p>Fig.3</p>					
13	Solderability of Termination	75% of the terminations is to be soldered evenly and continuously.	Immerse the capacitor in a solution of ethanol (JIS-K-8101) and rosin (JIS-K-5902) (25% rosin in weight proportion). Preheat at 80 to 120°C for 10 to 30 seconds. After preheating, immerse in eutectic solder solution for 2±0.5 seconds at 230±5°C.					
14	Resistance to Soldering Heat	Appearance	No defects or abnormalities.					
		Capacitance Change	Within ±7.5%					
		D.F.	0.01 max.					
		I.R.	More than 10,000MΩ or 500Ω • F (Whichever is smaller)					
		Dielectric Strength	No failure					
15	Temperature Cycle	Appearance	No defects or abnormalities.					
		Capacitance Change	Within ±7.5%					
		D.F.	0.01 max.					
		I.R.	More than 10,000MΩ or 500Ω • F (Whichever is smaller)					
		Dielectric Strength	No failure					
16	Humidity, Steady State	Appearance	No defects or abnormalities.					
		Capacitance Change	Within ±12.5%					
		D.F.	0.02 max.					
		I.R.	More than 1,000MΩ or 50Ω • F (Whichever is smaller)					
		Dielectric Strength	No failure					
17	Humidity Load	Appearance	No defects or abnormalities.					
		Capacitance Change	Within ±12.5%					
		D.F.	0.02 max.					
		I.R.	More than 500MΩ or 25Ω • F (Whichever is smaller)					
18	High Temperature Load	Appearance	No defects or abnormalities.					
		Capacitance Change	Within ±12.5%					
		D.F.	0.02 max.					
		I.R.	More than 1,000MΩ or 50Ω • F (Whichever is smaller)					

Chip Monolithic Ceramic Capacitors



Low ESL

■ Features

1. Low ESL, good for noise reduction for high frequency.
2. Small, high cap.

■ APPLICATION

- High speed micro processor.
- High frequency digital equipment

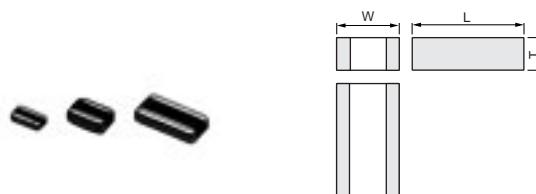

Part Number	Dimensions (mm)		
	L	W	T
LLL185	1.6 ±0.1	0.8 ±0.1	0.6 max.
LLL216	2.0 ±0.1	1.25 ±0.1	0.6 ±0.1
LLL219			0.85 ±0.1
LLL317	3.2 ±0.15	1.6 ±0.15	0.7 ±0.1
LLL31M			1.15 ±0.1

LLL18 Series (1.6x0.8mm)

Part Number	LLL18			
L x W	1.6x0.8			
TC	X7R (R7)			
Rated Volt.	10 (1A)	16 (1C)	25 (1E)	50 (1H)
Capacitance and T Dimension				
2200pF(222)				0.6(5)
2700pF(272)				0.6(5)
3300pF(332)				0.6(5)
3900pF(392)				0.6(5)
4700pF(472)				0.6(5)
5600pF(562)				0.6(5)
6800pF(682)			0.6(5)	
8200pF(822)			0.6(5)	
10000pF(103)			0.6(5)	
12000pF(123)			0.6(5)	
15000pF(153)			0.6(5)	
18000pF(183)			0.6(5)	
22000pF(223)			0.6(5)	
27000pF(273)		0.6(5)		
33000pF(333)		0.6(5)		
39000pF(393)		0.6(5)		
47000pF(473)		0.6(5)		
56000pF(563)		0.6(5)		
68000pF(683)		0.6(5)		
82000pF(823)	0.6(5)			
0.1μF(104)	0.6(5)			
0.12μF(124)	0.6(5)			

The part numbering code is shown in ().
Dimensions are shown in mm and Rated Voltage in Vdc.

10

LLL21 Series (2.0x1.25mm)

Part Number	LLL21			
L x W	2.0x1.25			
TC	X7R (R7)			
Rated Volt.	10 (1A)	16 (1C)	25 (1E)	50 (1H)
Capacitance and T Dimension				
0.22pF(224)	0.6(6)			
4700pF(472)				0.6(6)
5600pF(562)				0.6(6)
6800pF(682)				0.6(6)
8200pF(822)				0.6(6)
10000pF(103)				0.6(6)
12000pF(123)				0.6(6)
15000pF(153)				0.6(6)
18000pF(183)				0.6(6)
22000pF(223)				0.6(6)
27000pF(273)			0.6(6)	0.85(9)
33000pF(333)		0.6(6)	0.6(6)	0.85(9)
39000pF(393)		0.6(6)	0.6(6)	0.85(9)
47000pF(473)		0.6(6)	0.6(6)	
56000pF(563)		0.6(6)	0.6(6)	
68000pF(683)		0.6(6)	0.6(6)	
82000pF(823)		0.6(6)	0.6(6)	
0.1μF(104)		0.6(6)	0.6(6)	
0.12μF(124)		0.6(6)	0.85(9)	
0.15μF(154)		0.6(6)	0.85(9)	
0.18μF(184)		0.6(6)		
0.22μF(224)		0.85(9)		
0.27μF(274)	0.6(6)			
0.33μF(334)	0.6(6)			
0.39μF(394)	0.85(9)			
0.47μF(474)	0.85(9)			
0.56μF(564)	0.85(9)			

The part numbering code is shown in ().
Dimensions are shown in mm and Rated Voltage in Vdc.

LLL31 Series (3.2x1.6mm)

Part Number	LLL31			
L x W	3.2x1.6			
TC	X7R (R7)			
Rated Volt.	10 (1A)	16 (1C)	25 (1E)	50 (1H)
Capacitance and T Dimension				
10000pF(103)				0.7(7)
12000pF(123)				0.7(7)
15000pF(153)				0.7(7)
18000pF(183)				0.7(7)
22000pF(223)				0.7(7)
27000pF(273)				0.7(7)
33000pF(333)				0.7(7)
39000pF(393)				0.7(7)
47000pF(473)				0.7(7)

Continued on the following page. 

 Continued from the preceding page.

Part Number	LLL31			
L x W	3.2x1.6			
TC	X7R (R7)			
Rated Volt.	10 (1A)	16 (1C)	25 (1E)	50 (1H)
Capacitance and T Dimension				
56000pF(563)				0.7(7)
68000pF(683)				0.7(7)
82000pF(823)			0.7(7)	1.15(M)
0.1μF(104)		0.7(7)	0.7(7)	1.15(M)
0.12μF(124)		0.7(7)	0.7(7)	1.15(M)
0.15μF(154)		0.7(7)	0.7(7)	
0.18μF(184)		0.7(7)	0.7(7)	
0.22μF(224)		0.7(7)	1.15(M)	
0.27μF(274)		0.7(7)	1.15(M)	
0.33μF(334)		0.7(7)	1.15(M)	
0.39μF(394)		0.7(7)		
0.47μF(474)		0.7(7)	1.15(M)	
0.56μF(564)	0.7(7)	1.15(M)		
0.68μF(684)	0.7(7)	1.15(M)		
0.82μF(824)	0.7(7)	1.15(M)		
1.0μF(105)	0.7(7)	1.15(M)		
1.2μF(125)	1.15(M)			
1.5μF(155)	1.15(M)			
1.8μF(185)	1.15(M)			
2.2μF(225)	1.15(M)			

The part numbering code is shown in ().
Dimensions are shown in mm and Rated Voltage in Vdc.

Specifications and Test Methods

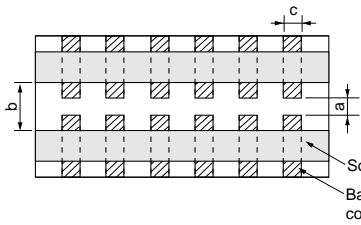
No.	Item	Specification	Test Method																
1	Operating Temperature Range	-55°C to +125°C																	
2	Rated Voltage	See the previous pages.	The rated voltage is defined as the maximum voltage which may be applied continuously to the capacitor. When AC voltage is superimposed on DC voltage, V^{P-P} or V^{0-P} , whichever is larger, shall be maintained within the rated voltage range.																
3	Appearance	No defects or abnormalities.	Visual inspection.																
4	Dimensions	Within the specified dimension.	Using calipers.																
5	Dielectric Strength	No defects or abnormalities.	No failure shall be observed when 250% of the rated voltage is applied between the terminations for 1 to 5 seconds, provided the charge/discharge current is less than 50mA.																
6	Insulation Resistance (I.R.)	More than 10,000MΩ or 500Ω • F (Whichever is smaller)	The insulation resistance shall be measured with a DC voltage not exceeding the rated voltage at 25°C and 75%RH max. and within 2 minutes of charging.																
7	Capacitance	Within the specified tolerance.	The capacitance/D.F. shall be measured at 25°C at the frequency and voltage shown in the table.																
8	Dissipation Factor (D.F.)	<table border="1" style="width: 100%; border-collapse: collapse; text-align: center;"> <thead> <tr style="background-color: #f2f2f2;"> <th>Char.</th> <th>25V min.</th> <th>16V</th> </tr> </thead> <tbody> <tr> <td>R7</td> <td>0.025 max.</td> <td>0.035 max.</td> </tr> </tbody> </table>	Char.	25V min.	16V	R7	0.025 max.	0.035 max.	<table border="1" style="width: 100%; border-collapse: collapse; text-align: center;"> <thead> <tr style="background-color: #f2f2f2;"> <th colspan="2">R7</th> </tr> </thead> <tbody> <tr> <td>Frequency</td> <td>1±0.1kHz</td> </tr> <tr> <td>Voltage</td> <td>1±0.2Vr.m.s.</td> </tr> </tbody> </table>	R7		Frequency	1±0.1kHz	Voltage	1±0.2Vr.m.s.				
Char.	25V min.	16V																	
R7	0.025 max.	0.035 max.																	
R7																			
Frequency	1±0.1kHz																		
Voltage	1±0.2Vr.m.s.																		
9	Capacitance Temperature Characteristics	<table border="1" style="width: 100%; border-collapse: collapse; text-align: center;"> <thead> <tr style="background-color: #f2f2f2;"> <th>Char.</th> <th>Temp. Range (°C)</th> <th>Reference Temp.</th> <th>Cap. Change.</th> </tr> </thead> <tbody> <tr> <td>R7</td> <td>-55 to +125</td> <td>25°C</td> <td>Within±15%</td> </tr> </tbody> </table>	Char.	Temp. Range (°C)	Reference Temp.	Cap. Change.	R7	-55 to +125	25°C	Within±15%	The ranges of capacitance change compared with the 25°C value over the temperature ranges shown in the table shall be within the specified ranges. The capacitance change shall be measured after 5 min. at each specified temperature stage.								
Char.	Temp. Range (°C)	Reference Temp.	Cap. Change.																
R7	-55 to +125	25°C	Within±15%																
10	Adhesive Strength of Termination	No removal of the terminations or other defect shall occur.	<p>Solder the capacitor to the test jig (glass epoxy board) shown in Fig.1 using a eutectic solder. Then apply 10N* force in the direction of the arrow. *5N:LLL18</p> <p>The soldering shall be done either with an iron or using the reflow method and shall be conducted with care so that the soldering is uniform and free of defects such as heat shock.</p> <div style="text-align: center;">  </div> <table border="1" style="width: 100%; border-collapse: collapse; text-align: center; margin-top: 10px;"> <thead> <tr style="background-color: #f2f2f2;"> <th>Type</th> <th>a</th> <th>b</th> <th>c</th> </tr> </thead> <tbody> <tr> <td>LLL18</td> <td>0.3</td> <td>1.2</td> <td>2.0</td> </tr> <tr> <td>LLL21</td> <td>0.6</td> <td>1.6</td> <td>2.4</td> </tr> <tr> <td>LLL31</td> <td>1.0</td> <td>3.0</td> <td>3.7</td> </tr> </tbody> </table> <p style="text-align: right;">(in mm)</p> <p style="text-align: center;">Fig.1</p>	Type	a	b	c	LLL18	0.3	1.2	2.0	LLL21	0.6	1.6	2.4	LLL31	1.0	3.0	3.7
Type	a	b	c																
LLL18	0.3	1.2	2.0																
LLL21	0.6	1.6	2.4																
LLL31	1.0	3.0	3.7																
11	Vibration Resistance	Appearance	No defects or abnormalities.																
		Capacitance	Within the specified tolerance.																
		D.F.	<table border="1" style="width: 100%; border-collapse: collapse; text-align: center;"> <thead> <tr style="background-color: #f2f2f2;"> <th>Char.</th> <th>25V min.</th> <th>16V</th> </tr> </thead> <tbody> <tr> <td>R7</td> <td>0.025 max.</td> <td>0.035 max.</td> </tr> </tbody> </table>	Char.	25V min.	16V	R7	0.025 max.	0.035 max.										
Char.	25V min.	16V																	
R7	0.025 max.	0.035 max.																	
			<p>Solder the capacitor to the test jig (glass epoxy board) in the same manner and under the same conditions as (10).</p> <p>The capacitor shall be subjected to a simple harmonic motion having a total amplitude of 1.5mm, the frequency being varied uniformly between the approximate limits of 10 and 55Hz. The frequency range, from 10 to 55Hz and return to 10Hz, shall be traversed in approximately 1 minute. This motion shall be applied for a period of 2 hours in each 3 mutually perpendicular directions (total of 6 hours).</p>																

Continued on the following page.

Specifications and Test Methods

Continued from the preceding page.

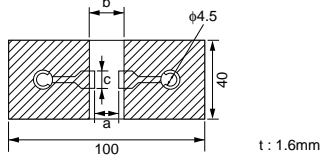
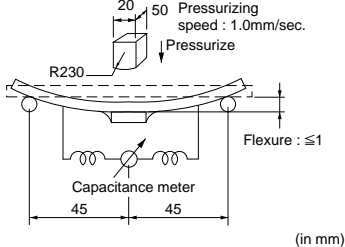
No.	Item	Specification	Test Method													
12	Deflection	No crack or marked defect shall occur.	<p>Solder the capacitor to the test jig (glass epoxy boards) shown in Fig.2 using a eutectic solder.</p> <p>Then apply a force in the direction shown in Fig.3.</p> <p>The soldering shall be done either with an iron or using the reflow method and shall be conducted with care so that the soldering is uniform and free of defects such as heat shock.</p>													
		<div style="text-align: center;">  <p style="text-align: center;">t : 1.6mm</p> <table border="1" style="margin-left: auto; margin-right: auto;"> <thead> <tr> <th>Type</th> <th>a</th> <th>b</th> <th>c</th> </tr> </thead> <tbody> <tr> <td>LLL18</td> <td>0.3</td> <td>1.2</td> <td>2.0</td> </tr> <tr> <td>LLL21</td> <td>0.6</td> <td>1.6</td> <td>2.4</td> </tr> <tr> <td>LLL31</td> <td>1.0</td> <td>3.0</td> <td>3.7</td> </tr> </tbody> </table> <p style="text-align: center;">(in mm)</p> <p style="text-align: center;">Fig.2</p> </div>		Type	a	b	c	LLL18	0.3	1.2	2.0	LLL21	0.6	1.6	2.4	LLL31
Type	a	b	c													
LLL18	0.3	1.2	2.0													
LLL21	0.6	1.6	2.4													
LLL31	1.0	3.0	3.7													
			<div style="text-align: center;">  <p style="text-align: center;">(in mm)</p> <p style="text-align: center;">Fig.3</p> </div>													
13	Solderability of Termination	75% of the terminations is to be soldered evenly and continuously.	Immerse the capacitor in a solution of ethanol (JIS-K-8101) and rosin (JIS-K-5902) (25% rosin in weight proportion). Preheat at 80 to 120°C for 10 to 30 seconds. After preheating, immerse in eutectic solder solution for 2±0.5 seconds at 230±5°C.													
14	Resistance to Soldering Heat	Appearance	No defects or abnormalities.													
		Capacitance Change	Within±7.5%													
		D.F.	<table border="1" style="width: 100%; text-align: center;"> <thead> <tr> <th>Char.</th> <th>25V min.</th> <th>16V</th> </tr> </thead> <tbody> <tr> <td>R7</td> <td>0.025 max.</td> <td>0.035 max.</td> </tr> </tbody> </table>	Char.	25V min.	16V	R7	0.025 max.	0.035 max.							
		Char.	25V min.	16V												
		R7	0.025 max.	0.035 max.												
I.R.	More than 10,000MΩ or 500Ω • F (Whichever is smaller)															
Dielectric Strength	No failure															
15	Temperature Cycle	Appearance	No defects or abnormalities.													
		Capacitance Change	Within±7.5%													
		D.F.	<table border="1" style="width: 100%; text-align: center;"> <thead> <tr> <th>Char.</th> <th>25V min.</th> <th>16V</th> </tr> </thead> <tbody> <tr> <td>R7</td> <td>0.025 max.</td> <td>0.035 max.</td> </tr> </tbody> </table>	Char.	25V min.	16V	R7	0.025 max.	0.035 max.							
		Char.	25V min.	16V												
		R7	0.025 max.	0.035 max.												
I.R.	More than 10,000MΩ or 500Ω • F (Whichever is smaller)															
Dielectric Strength	No failure															
16	Humidity, Steady State	Appearance	No defects or abnormalities.													
		Capacitance Change	Within±12.5%													
		D.F.	<table border="1" style="width: 100%; text-align: center;"> <thead> <tr> <th>Char.</th> <th>25V min.</th> <th>16V</th> </tr> </thead> <tbody> <tr> <td>R7</td> <td>0.05 max.</td> <td>0.05 max.</td> </tr> </tbody> </table>	Char.	25V min.	16V	R7	0.05 max.	0.05 max.							
		Char.	25V min.	16V												
R7	0.05 max.	0.05 max.														
I.R.	More than 1,000MΩ or 50Ω • F (Whichever is smaller)															
17	Humidity Load	Appearance	No defects or abnormalities.													
		Capacitance Change	Within±12.5%													
		D.F.	<table border="1" style="width: 100%; text-align: center;"> <thead> <tr> <th>Char.</th> <th>25V min.</th> <th>16V</th> </tr> </thead> <tbody> <tr> <td>R7</td> <td>0.05 max.</td> <td>0.05 max.</td> </tr> </tbody> </table>	Char.	25V min.	16V	R7	0.05 max.	0.05 max.							
		Char.	25V min.	16V												
		R7	0.05 max.	0.05 max.												
I.R.	More than 500MΩ or 25Ω • F (Whichever is smaller)															
Dielectric Strength	No failure															

10

Continued on the following page. ↗

Specifications and Test Methods

 Continued from the preceding page.

No.	Item	Specification	Test Method						
18	Appearance	No defects or abnormalities.	Apply 200% of the rated voltage for 1,000±12 hours at maximum operating temperature ±3°C. Let sit for 48±4 hours at room temperature, then measure. The charge/discharge current is less than 50mA. •Initial measurement. Apply 200% of the rated DC voltage for one hour at the maximum operating temperature ±3°C. Remove and let sit for 48±4 hours at room temperature. Perform initial measurement.						
	Capacitance Change	Within±12.5%							
	D.F.	<table border="1"> <thead> <tr> <th>Char.</th> <th>25V min.</th> <th>16V</th> </tr> </thead> <tbody> <tr> <td>R7</td> <td>0.05 max.</td> <td>0.05 max.</td> </tr> </tbody> </table>		Char.	25V min.	16V	R7	0.05 max.	0.05 max.
	Char.	25V min.		16V					
	R7	0.05 max.		0.05 max.					
I.R.	More than 1,000MΩ or 50Ω • F (Whichever is smaller)								
Dielectric Strength	No failure								

Chip Monolithic Ceramic Capacitors



High Frequency for Flow/Reflow Soldering

■ Features

1. HiQ and low ESR at VHF, UHF, Microwave.
2. Feature improvement, low power consumption for mobile telecommunication. (Base station, terminal, etc.)

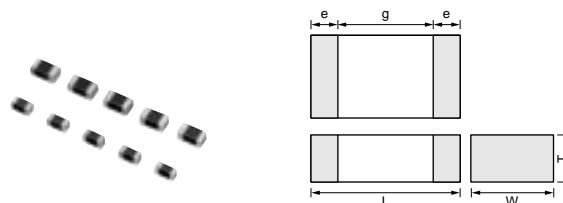

■ Applications

High-frequency circuit (Mobile telecommunication, etc.)

Part Number	Dimensions (mm)				
	L	W	T	e	g min.
GQM188	1.6 ±0.1	0.8 ±0.1	0.8 ±0.1	0.2 to 0.5	0.5
GQM219	2.0 ±0.1	1.25 ±0.1	0.85 ±0.1	0.2 to 0.7	0.7

Part Number	GQM18		GQM21	
L x W	1.60x0.80		2.00x1.25	
TC	COG (5C)		COG (5C)	
Rated Volt.	50 (1H)	100 (2A)	50 (1H)	100 (2A)
Capacitance and T Dimension				
0.5pF(1R0)		0.80(8)		0.85(9)
0.75pF(1R5)		0.80(8)		0.85(9)
1.0pF(2R0)		0.80(8)		0.85(9)
1.1pF(2R1)		0.80(8)		0.85(9)
1.2pF(2R2)		0.80(8)		0.85(9)
1.3pF(2R3)		0.80(8)		0.85(9)
1.5pF(2R5)		0.80(8)		0.85(9)
1.6pF(2R6)		0.80(8)		0.85(9)
1.8pF(2R8)		0.80(8)		0.85(9)
2.0pF(3R0)		0.80(8)		0.85(9)
2.2pF(3R2)		0.80(8)		0.85(9)
2.4pF(3R4)		0.80(8)		0.85(9)
2.7pF(3R7)		0.80(8)		0.85(9)
3.0pF(4R0)		0.80(8)		0.85(9)
3.3pF(4R3)		0.80(8)		0.85(9)
3.6pF(4R6)		0.80(8)		0.85(9)
3.9pF(4R9)		0.80(8)		0.85(9)
4.0pF(5R0)		0.80(8)		0.85(9)
4.3pF(5R3)		0.80(8)		0.85(9)
4.7pF(5R7)		0.80(8)		0.85(9)
5.0pF(6R0)		0.80(8)		0.85(9)
5.1pF(6R1)		0.80(8)		0.85(9)
5.6pF(6R6)		0.80(8)		0.85(9)
6.0pF(7R0)		0.80(8)		0.85(9)
6.2pF(7R2)		0.80(8)		0.85(9)
6.8pF(7R8)		0.80(8)		0.85(9)
7.0pF(8R0)	0.80(8)			0.85(9)
7.5pF(8R5)	0.80(8)			0.85(9)
8.0pF(9R0)	0.80(8)			0.85(9)
8.2pF(9R2)	0.80(8)			0.85(9)
9.0pF(10R0)	0.80(8)			0.85(9)
9.1pF(10R1)	0.80(8)			0.85(9)
10.0pF(11R0)	0.80(8)			0.85(9)

Continued on the following page.

Continued from the preceding page.

Part Number	GQM18		GQM21	
L x W	1.60x0.80		2.00x1.25	
TC	COG (5C)		COG (5C)	
Rated Volt.	50 (1H)	100 (2A)	50 (1H)	100 (2A)
Capacitance and T Dimension				
11pF(110)	0.80(8)			0.85(9)
12pF(120)	0.80(8)			0.85(9)
13pF(130)	0.80(8)			0.85(9)
15pF(150)	0.80(8)			0.85(9)
16pF(160)	0.80(8)			0.85(9)
18pF(180)	0.80(8)			0.85(9)
20pF(200)	0.80(8)		0.85(9)	
22pF(220)	0.80(8)		0.85(9)	
24pF(240)	0.80(8)		0.85(9)	
27pF(270)			0.85(9)	
30pF(300)			0.85(9)	
33pF(330)			0.85(9)	
36pF(360)			0.85(9)	
39pF(390)			0.85(9)	
43pF(430)			0.85(9)	
47pF(470)			0.85(9)	

The part numbering code is shown in ().
Dimensions are shown in mm and Rated Voltage in Vdc.

Q-Frequency Characteristics

Resonant Frequency-Capacitance

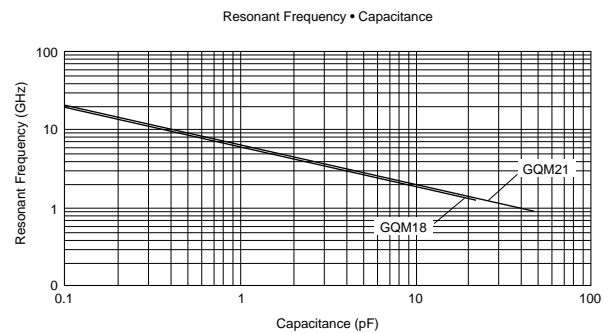
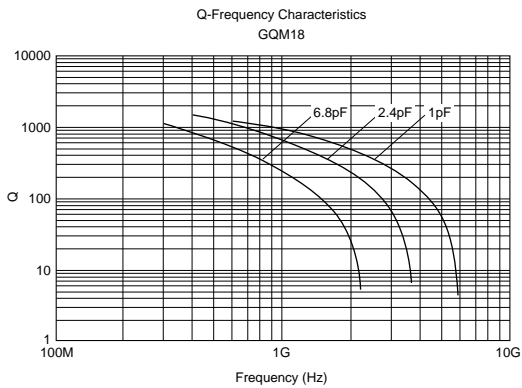

11

Specifications and Test Methods

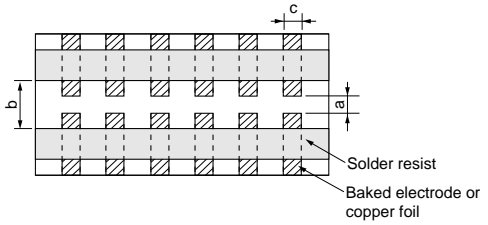
No.	Item	Specification	Test Method												
1	Operating Temperature Range	COG : -55°C to 125°C													
2	Rated Voltage	See the previous pages.	The rated voltage is defined as the maximum voltage which may be applied continuously to the capacitor. When AC voltage is superimposed on DC voltage, V^{P-P} or V^{O-P} , whichever is larger, shall be maintained within the rated voltage range.												
3	Appearance	No defects or abnormalities.	Visual inspection.												
4	Dimensions	Within the specified dimensions.	Using calipers.												
5	Dielectric Strength	No defects or abnormalities.	No failure shall be observed when 300% of the rated voltage is applied between the terminations for 1 to 5 seconds, provided the charge/discharge current is less than 50mA.												
6	Insulation Resistance (I.R.)	More than 10,000MΩ or 500Ω • F. (Whichever is smaller)	The insulation resistance shall be measured with a DC voltage not exceeding the rated voltage at 25°C and 75%RH max. and within 2 minutes of charging.												
7	Capacitance	Within the specified tolerance.	The capacitance/Q shall be measured at 25°C at the frequency and voltage shown in the table.												
8	Q	$Q \geq 1000$	<table border="1" style="margin-left: auto; margin-right: auto;"> <thead> <tr> <th>Item</th> <th>Char.</th> <th>COG(1000pF and below)</th> </tr> </thead> <tbody> <tr> <td>Frequency</td> <td></td> <td>1±0.1MHz</td> </tr> <tr> <td>Voltage</td> <td></td> <td>0.5 to 5Vrms</td> </tr> </tbody> </table>	Item	Char.	COG(1000pF and below)	Frequency		1±0.1MHz	Voltage		0.5 to 5Vrms			
Item	Char.	COG(1000pF and below)													
Frequency		1±0.1MHz													
Voltage		0.5 to 5Vrms													
9	Capacitance Temperature Characteristics	Capacitance Change	Within the specified tolerance. (Table A-1)												
		Temperature Coefficient	Within the specified tolerance. (Table A-1)												
		Capacitance Drift	Within ±0.2% or ±0.05pF (Whichever is larger.)												
10	Adhesive Strength of Termination	No removal of the terminations or other defect shall occur.	<p>The temperature coefficient is determined using the capacitance measured in step 3 as a reference.</p> <p>When cycling the temperature sequentially from step 1 through 5, the capacitance shall be within the specified tolerance for the temperature coefficient and capacitance change as Table A.</p> <p>The capacitance drift is calculated by dividing the differences between the maximum and minimum measured values in the step 1, 3 and 5 by the cap. value in step 3.</p> <table border="1" style="margin-left: auto; margin-right: auto;"> <thead> <tr> <th>Step</th> <th>Temperature(°C)</th> </tr> </thead> <tbody> <tr> <td>1</td> <td>25±2</td> </tr> <tr> <td>2</td> <td>-55±3</td> </tr> <tr> <td>3</td> <td>25±2</td> </tr> <tr> <td>4</td> <td>125±3</td> </tr> <tr> <td>5</td> <td>25±2</td> </tr> </tbody> </table>	Step	Temperature(°C)	1	25±2	2	-55±3	3	25±2	4	125±3	5	25±2
			Step	Temperature(°C)											
1	25±2														
2	-55±3														
3	25±2														
4	125±3														
5	25±2														
		<p>Solder the capacitor to the test jig (glass epoxy board) shown in Fig.1 using a eutectic solder. Then apply 10N* force in parallel with the test jig for 10±1sec.</p> <p>The soldering shall be done either with an iron or using the reflow method and shall be conducted with care so that the soldering is uniform and free of defects such as heat shock.</p> <p style="text-align: right;">*5N (GQM18)</p> <div style="text-align: center;">  <p style="text-align: right;">Solder resist Baked electrode or copper foil</p> <table border="1" style="margin-left: auto; margin-right: auto;"> <thead> <tr> <th>Type</th> <th>a</th> <th>b</th> <th>c</th> </tr> </thead> <tbody> <tr> <td>GQM18</td> <td>1.0</td> <td>3.0</td> <td>1.2</td> </tr> <tr> <td>GQM21</td> <td>1.2</td> <td>4.0</td> <td>1.65</td> </tr> </tbody> </table> <p style="text-align: right;">(in mm)</p> </div> <p style="text-align: center;">Fig.1</p>	Type	a	b	c	GQM18	1.0	3.0	1.2	GQM21	1.2	4.0	1.65	
Type	a	b	c												
GQM18	1.0	3.0	1.2												
GQM21	1.2	4.0	1.65												
11	Vibration Resistance	Appearance	No defects or abnormalities.												
		Capacitance	Within the specified tolerance.												
		Q	$Q \geq 1000$												
			<p>Solder the capacitor to the test jig (glass epoxy board) in the same manner and under the same conditions as (10).</p> <p>The capacitor shall be subjected to a simple harmonic motion having a total amplitude of 1.5mm, the frequency being varied uniformly between the approximate limits of 10 and 55Hz. The frequency range, from 10 to 55Hz and return to 10Hz, shall be traversed in approximately 1 minute. This motion shall be applied for a period of 2 hours in each 3 mutually perpendicular directions (total of 6 hours).</p>												

11

Continued on the following page.

Specifications and Test Methods

Continued from the preceding page.

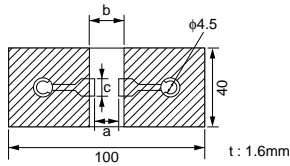
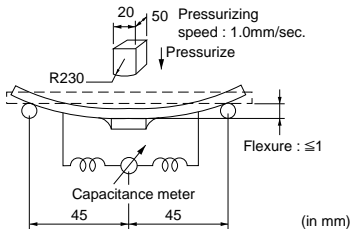
No.	Item	Specification	Test Method															
12	Deflection	No cracking or marking defects shall occur.	<p>Solder the capacitor to the test jig (glass epoxy board) shown in Fig.2 using a eutectic solder. Then apply a force in the direction shown in Fig.3. The soldering shall be done either with an iron or using the reflow method and shall be conducted with care so that the soldering is uniform and free of defects such as heat shock.</p>  <table border="1" data-bbox="368 589 880 667"> <thead> <tr> <th>Type</th> <th>a</th> <th>b</th> <th>c</th> </tr> </thead> <tbody> <tr> <td>GQM18</td> <td>1.0</td> <td>3.0</td> <td>1.2</td> </tr> <tr> <td>GQM21</td> <td>1.2</td> <td>4.0</td> <td>1.65</td> </tr> </tbody> </table> <p>(in mm)</p>	Type	a	b	c	GQM18	1.0	3.0	1.2	GQM21	1.2	4.0	1.65			
		Type		a	b	c												
GQM18	1.0	3.0	1.2															
GQM21	1.2	4.0	1.65															
 <p>(in mm)</p>			Fig.3															
13	Solderability of Termination	75% of the terminations is to be soldered evenly and continuously.	Immerse the capacitor in a solution of ethanol (JIS-K-8101) and rosin (JIS-K-5902) (25% rosin in weight proportion). Preheat at 80 to 120°C for 10 to 30 seconds. After preheating, immerse in eutectic solder solution for 2±0.5 seconds at 230±5°C.															
14	Resistance to Soldering Heat	The measured and observed characteristics shall satisfy the specifications in the following table.	Preheat the capacitor at 120 to 150°C for 1 minute. Immerse the capacitor in a eutectic solder solution at 270±5°C for 10±0.5 seconds. Let sit at room temperature for 24±2 hours.															
		Appearance		No marking defects.														
		Capacitance Change		Within ±2.5% or ±0.25pF (Whichever is larger)														
		Q		Q≥1000														
		I.R.		More than 10,000MΩ or 500Ω • F (Whichever is smaller)														
Dielectric Strength	No failure																	
15	Temperature Cycle	The measured and observed characteristics shall satisfy the specifications in the following table.	<p>Fix the capacitor to the supporting jig in the same manner and under the same conditions as (10). Perform the five cycles according to the four heat treatments listed in the following table. Let sit for 24±2 hours at room temperature, then measure.</p> <table border="1" data-bbox="938 1301 1449 1413"> <thead> <tr> <th>Step</th> <th>1</th> <th>2</th> <th>3</th> <th>4</th> </tr> </thead> <tbody> <tr> <td>Temp.(°C)</td> <td>Min. Operating Temp.+0/-3</td> <td>Room Temp.</td> <td>Max. Operating Temp.+3/-0</td> <td>Room Temp.</td> </tr> <tr> <td>Time(min.)</td> <td>30±3</td> <td>2 to 3</td> <td>30±3</td> <td>2 to 3</td> </tr> </tbody> </table>	Step	1	2	3	4	Temp.(°C)	Min. Operating Temp.+0/-3	Room Temp.	Max. Operating Temp.+3/-0	Room Temp.	Time(min.)	30±3	2 to 3	30±3	2 to 3
		Step		1	2	3	4											
		Temp.(°C)		Min. Operating Temp.+0/-3	Room Temp.	Max. Operating Temp.+3/-0	Room Temp.											
		Time(min.)		30±3	2 to 3	30±3	2 to 3											
		Appearance		No marking defects.														
Capacitance Change	Within ±2.5% or ±0.25pF (Whichever is larger)																	
Q	Q≥1000																	
I.R.	More than 10,000MΩ or 500Ω • F (Whichever is smaller)																	
Dielectric Strength	No failure																	
16	Humidity, Steady State	The measured and observed characteristics shall satisfy the specifications in the following table.	<p>Sit the capacitor at 40±2°C and 90 to 95% humidity for 500±12 hours. Remove and let sit for 24±2 hours (temperature compensating type) at room temperature, then measure.</p>															
		Appearance		No marking defects.														
		Capacitance Change		Within ±5% or ±0.5pF (Whichever is larger)														
		Q		Q≥350														
		I.R.		More than 1,000MΩ or 50Ω • F (Whichever is smaller)														
Dielectric Strength	No failure																	
17	Humidity Load	The measured and observed characteristics shall satisfy the specifications in the following table.	<p>Apply the rated voltage at 40±2°C and 90 to 95% humidity for 500±12 hours. Remove and let sit for 24±2 hours at room temperature, then measure. The charge/discharge current is less than 50mA.</p>															
		Appearance		No marking defects.														
		Capacitance Change		Within ±7.5% or ±0.75pF (Whichever is larger)														
		Q		Q≥200														
		I.R.		More than 500MΩ or 25Ω • F (Whichever is smaller)														
Dielectric Strength	No failure																	

Continued on the following page. ↗

Specifications and Test Methods

 Continued from the preceding page.

No.	Item	Specification	Test Method	
18	High Temperature Load	The measured and observed characteristics shall satisfy the specifications in the following table.	Apply 200% of the rated voltage for 1,000±12 hours at the maximum operating temperature ±3°C. Let sit for 24±2 hours (temperature compensating type) at room temperature, then measure. The charge/discharge current is less than 50mA.	
		Appearance		No marking defects.
		Capacitance Change		Within ±3% or ±0.3pF (Whichever is larger)
		Q		Q≥350
		I.R.		More than 1,000MΩ or 50Ω • F (Whichever is smaller)
	Dielectric Strength	No failure		

Table A

Char. Code	Nominal Values (ppm/°C) Note 1	Capacitance Change from 25°C (%)					
		-55°C		-30°C		-10°C	
		Max.	Min.	Max.	Min.	Max.	Min.
COG	0±30	0.58	-0.24	0.40	-0.17	0.25	-0.11

Note 1 : Nominal values denote the temperature coefficient within a range of 25°C to 125°C. (for COG)

Chip Monolithic Ceramic Capacitors



High-Q & High Power Type

■ Features(ERF Series)

1. The dielectric is composed of low dielectric loss ceramic. This series is perfectly suited to high-frequency applications. (VHS-microwave band)
2. The series is ultraminiature, yet has a high-power capacity. This is the best capacitor available for transmitter and amplifier circuits such as those in broadcasting equipment and mobile base stations.
3. ERF1D type is designed for both flow and reflow soldering and ERF22 type is designed for reflow soldering.

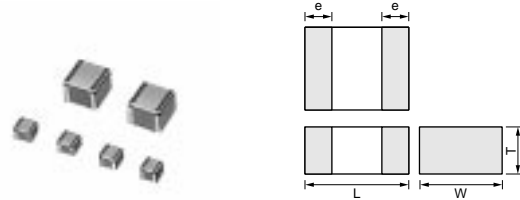

Part Number	Dimensions (mm)			
	L	W	T	e
ERF1DM	1.4 ^{+0.6} _{-0.4}	1.4 ^{+0.6} _{-0.4}	1.15 ^{+0.50} _{-0.35}	0.25 ^{+0.25} _{-0.15}
ERF22X	2.8 ^{+0.6} _{-0.4}	2.8 ^{+0.6} _{-0.4}	2.3 ^{+0.5} _{-0.3}	0.4 ^{+0.4} _{-0.3}

■ Applications

High-frequency and high-power circuits.

■ Features(ERH Series)

1. The dielectric is composed of low dielectric loss ceramics. This series is perfectly suited to high-frequency applications (VHS-microwave band).
2. The series is ultraminiature, yet has a high-power capacity. This is the best capacitor available for transmitter and amplifier circuits such as those in broadcasting equipment and mobile base stations.
3. ERH1X/3X Series capacitors withstand high temperatures because ribbon leads are attached with silver paste.
4. ERH1X/3X Series capacitors are easily soldered and especially well suited in applications where only a soldering iron can be used.

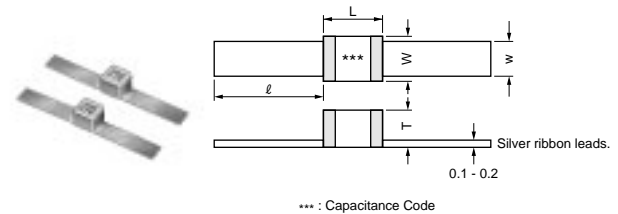

Part Number	Dimensions (mm)				
	L	W	T max.	ℓ	w
ERH1XC	1.6 ±0.4	1.4 ±0.4	1.6	5.0 min.	1.3 ±0.4
ERH3XX	3.2 ±0.4	2.8 ±0.4	3.0	9.0 ±2.0	2.35 ±0.15

■ Applications

High-frequency and high-power circuits.

Part Number	ERF1D		ERF22					ERH1X		ERH3X				
L x W	1.40x1.40		2.80x2.80					1.60x1.40		3.20x2.80				
TC	C0G (5C)		C0G (5C)					C0G (5C)		C0G (5C)				
Rated Volt.	50 (1H)	50 (1H)	100 (2A)	200 (2D)	300 (YD)	500 (2H)	50 (1H)	50 (1H)	100 (2A)	200 (2D)	300 (YD)	500 (2H)		
Capacitance and T Dimension														
0.5pF(R50)	1.15(M)					2.30(X)	1.60(C)					3.00(X)		
0.6pF(R60)	1.15(M)					2.30(X)	1.60(C)					3.00(X)		
0.7pF(R70)	1.15(M)					2.30(X)	1.60(C)					3.00(X)		
0.8pF(R80)	1.15(M)					2.30(X)	1.60(C)					3.00(X)		
0.9pF(R90)	1.15(M)					2.30(X)	1.60(C)					3.00(X)		
1.0pF(1R0)	1.15(M)					2.30(X)	1.60(C)					3.00(X)		
1.1pF(1R1)	1.15(M)					2.30(X)	1.60(C)					3.00(X)		
1.2pF(1R2)	1.15(M)					2.30(X)	1.60(C)					3.00(X)		
1.3pF(1R3)	1.15(M)					2.30(X)	1.60(C)					3.00(X)		
1.4pF(1R4)	1.15(M)					2.30(X)	1.60(C)					3.00(X)		
1.5pF(1R5)	1.15(M)					2.30(X)	1.60(C)					3.00(X)		

Continued on the following page.

 Continued from the preceding page.

Part Number	ERF1D	ERF22					ERH1X	ERH3X				
L x W	1.40x1.40	2.80x2.80					1.60x1.40	3.20x2.80				
TC	COG (5C)	COG (5C)					COG (5C)	COG (5C)				
Rated Volt.	50 (1H)	50 (1H)	100 (2A)	200 (2D)	300 (YD)	500 (2H)	50 (1H)	50 (1H)	100 (2A)	200 (2D)	300 (YD)	500 (2H)
Capacitance and T Dimension												
1.6pF(1R6)	1.15(M)					2.30(X)	1.60(C)					3.00(X)
1.7pF(1R7)	1.15(M)					2.30(X)	1.60(C)					3.00(X)
1.8pF(1R8)	1.15(M)					2.30(X)	1.60(C)					3.00(X)
1.9pF(1R9)	1.15(M)					2.30(X)	1.60(C)					3.00(X)
2.0pF(2R0)	1.15(M)					2.30(X)	1.60(C)					3.00(X)
2.1pF(2R1)	1.15(M)					2.30(X)	1.60(C)					3.00(X)
2.2pF(2R2)	1.15(M)					2.30(X)	1.60(C)					3.00(X)
2.4pF(2R4)	1.15(M)					2.30(X)	1.60(C)					3.00(X)
2.7pF(2R7)	1.15(M)					2.30(X)	1.60(C)					3.00(X)
3.0pF(3R0)	1.15(M)					2.30(X)	1.60(C)					3.00(X)
3.3pF(3R3)	1.15(M)					2.30(X)	1.60(C)					3.00(X)
3.6pF(3R6)	1.15(M)					2.30(X)	1.60(C)					3.00(X)
3.9pF(3R9)	1.15(M)					2.30(X)	1.60(C)					3.00(X)
4.3pF(4R3)	1.15(M)					2.30(X)	1.60(C)					3.00(X)
4.7pF(4R7)	1.15(M)					2.30(X)	1.60(C)					3.00(X)
5.1pF(5R1)	1.15(M)					2.30(X)	1.60(C)					3.00(X)
5.6pF(5R6)	1.15(M)					2.30(X)	1.60(C)					3.00(X)
6.2pF(6R2)	1.15(M)					2.30(X)	1.60(C)					3.00(X)
6.8pF(6R8)	1.15(M)					2.30(X)	1.60(C)					3.00(X)
7.5pF(7R5)	1.15(M)					2.30(X)	1.60(C)					3.00(X)
8.2pF(8R2)	1.15(M)					2.30(X)	1.60(C)					3.00(X)
9.1pF(9R1)	1.15(M)					2.30(X)	1.60(C)					3.00(X)
10.0pF(100)	1.15(M)					2.30(X)	1.60(C)					3.00(X)
11pF(110)	1.15(M)					2.30(X)	1.60(C)					3.00(X)
12pF(120)	1.15(M)					2.30(X)	1.60(C)					3.00(X)
13pF(130)	1.15(M)					2.30(X)	1.60(C)					3.00(X)
15pF(150)	1.15(M)					2.30(X)	1.60(C)					3.00(X)
16pF(160)	1.15(M)					2.30(X)	1.60(C)					3.00(X)
18pF(180)	1.15(M)					2.30(X)	1.60(C)					3.00(X)
20pF(200)	1.15(M)					2.30(X)	1.60(C)					3.00(X)
22pF(220)	1.15(M)					2.30(X)	1.60(C)					3.00(X)
24pF(240)	1.15(M)					2.30(X)	1.60(C)					3.00(X)
27pF(270)	1.15(M)					2.30(X)	1.60(C)					3.00(X)
30pF(300)	1.15(M)					2.30(X)	1.60(C)					3.00(X)
33pF(330)	1.15(M)					2.30(X)	1.60(C)					3.00(X)
36pF(360)	1.15(M)					2.30(X)	1.60(C)					3.00(X)
39pF(390)	1.15(M)					2.30(X)	1.60(C)					3.00(X)
43pF(430)	1.15(M)					2.30(X)	1.60(C)					3.00(X)
47pF(470)	1.15(M)					2.30(X)	1.60(C)					3.00(X)
51pF(510)	1.15(M)					2.30(X)	1.60(C)					3.00(X)
56pF(560)	1.15(M)					2.30(X)	1.60(C)					3.00(X)
62pF(620)	1.15(M)					2.30(X)	1.60(C)					3.00(X)
68pF(680)	1.15(M)					2.30(X)	1.60(C)					3.00(X)
75pF(750)	1.15(M)					2.30(X)	1.60(C)					3.00(X)
82pF(820)	1.15(M)					2.30(X)	1.60(C)					3.00(X)
91pF(910)	1.15(M)					2.30(X)	1.60(C)					3.00(X)
100pF(101)	1.15(M)					2.30(X)	1.60(C)					3.00(X)
110pF(111)					2.30(X)							3.00(X)
120pF(121)					2.30(X)							3.00(X)
130pF(131)					2.30(X)							3.00(X)
150pF(151)					2.30(X)							3.00(X)
160pF(161)					2.30(X)							3.00(X)

Continued on the following page. 

 Continued from the preceding page.

Part Number	ERF1D	ERF22					ERH1X	ERH3X				
L x W	1.40x1.40	2.80x2.80					1.60x1.40	3.20x2.80				
TC	C0G (5C)	C0G (5C)					C0G (5C)	C0G (5C)				
Rated Volt.	50 (1H)	50 (1H)	100 (2A)	200 (2D)	300 (YD)	500 (2H)	50 (1H)	50 (1H)	100 (2A)	200 (2D)	300 (YD)	500 (2H)
Capacitance and T Dimension												
180pF(181)					2.30(X)						3.00(X)	
200pF(201)					2.30(X)						3.00(X)	
220pF(221)				2.30(X)						3.00(X)		
240pF(241)				2.30(X)						3.00(X)		
270pF(271)				2.30(X)						3.00(X)		
300pF(301)				2.30(X)						3.00(X)		
330pF(331)				2.30(X)						3.00(X)		
360pF(361)				2.30(X)						3.00(X)		
390pF(391)				2.30(X)						3.00(X)		
430pF(431)				2.30(X)						3.00(X)		
470pF(471)				2.30(X)						3.00(X)		
510pF(511)			2.30(X)						3.00(X)			
560pF(561)			2.30(X)						3.00(X)			
620pF(621)			2.30(X)						3.00(X)			
680pF(681)			2.30(X)						3.00(X)			
750pF(751)		2.30(X)						3.00(X)				
820pF(821)		2.30(X)						3.00(X)				
910pF(911)		2.30(X)						3.00(X)				
1000pF(102)		2.30(X)						3.00(X)				

The part numbering code is shown in ().
Dimensions are shown in mm and Rated Voltage in Vdc.

Specifications and Test Methods

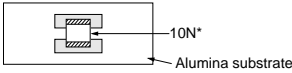
No.	Item	Specification	Test Method						
1	Operating Temperature Range	-55°C to +125°C							
2	Rated Voltage	See the previous pages.	The rated voltage is defined as the maximum voltage which may be applied continuously to the capacitor. When AC voltage is superimposed on DC voltage, V^{P-P} or V^{O-P} , whichever is larger, shall be maintained within the rated voltage range.						
3	Appearance	No defects or abnormalities.	Visual inspection.						
4	Dimensions	Within the specified dimension.	Using calipers.						
5	Dielectric Strength	No defects or abnormalities.	No failure shall be observed when 250% of the rated voltage is applied between the terminations for 1 to 5 seconds, provided the charge/discharge current is less than 50mA.						
6	Insulation Resistance (I.R.)	25°C $C \leq 470\text{pF} : 1,000,000\text{M}\Omega \text{ min.}$ $470\text{pF} < C \leq 1,000\text{pF} : 100,000\text{M}\Omega \text{ min.}$	The insulation resistance shall be measured with a DC voltage not exceeding the rated voltage at 25°C and 125°C standard humidity and within 2 minutes of charging.						
		125°C $C \leq 470\text{pF} : 100,000\text{M}\Omega \text{ min.}$ $470\text{pF} < C \leq 1,000\text{pF} : 10,000\text{M}\Omega \text{ min.}$							
7	Capacitance	Within the specified tolerance.	The capacitance/Q shall be measured at 25°C at the frequency and voltage shown in the table.						
8	Q	$C \leq 220\text{pF} : Q \geq 10,000$ $220\text{pF} < C \leq 470\text{pF} : Q \geq 5,000$ $470\text{pF} < C \leq 1,000\text{pF} : Q \geq 3,000$ C : Nominal Capacitance (pF)	<table border="1" style="width: 100%; border-collapse: collapse;"> <thead> <tr> <th>Item</th> <th></th> </tr> </thead> <tbody> <tr> <td>Frequency</td> <td style="text-align: center;">1±0.1MHz</td> </tr> <tr> <td>Voltage</td> <td style="text-align: center;">0.5 to 5Vr.m.s.</td> </tr> </tbody> </table>	Item		Frequency	1±0.1MHz	Voltage	0.5 to 5Vr.m.s.
		Item							
Frequency	1±0.1MHz								
Voltage	0.5 to 5Vr.m.s.								
9	Capacitance Temperature Characteristics	Capacitance Variation Rate Within the specified tolerance. (Table A-7)	The temperature coefficient is determined using the capacitance measured in step 3 as a reference. When cycling the temperature sequentially from step 1 through 5, the capacitance shall be within the specified tolerance for the temperature coefficient and capacitance change as Table A. The capacitance drift is calculated by dividing the differences between the maximum and minimum measured values in the step 1, 3 and 5 by the cap. value in step 3. The capacitance change shall be measured after 5 min. at each specified temperature stage.						
		Temperature Coefficient Within the specified tolerance. (Table A-7)							
		Capacitance Drift Within ±0.2% or ±0.05pF (Whichever is larger)							
10	Terminal Strength	Adhesive Strength of Termination (for chip type) No removal of the terminations or other defects shall occur.	Solder the capacitor to the test jig (alumina substrate) shown in Fig.1 using solder containing 2.5% silver. The soldering shall be done either with an iron or in furnace and be conducted with care so the soldering is uniform and free of defects such as heat shock. Then apply a 10N* force in the direction of the arrow. <div style="text-align: right;">*ERF1D : 5N</div>  <p style="text-align: center;">Fig.1</p>						
		Tensile Strength (for micro-strip type) Capacitor shall not be broken or damaged.	The capacitor body is fixed and a load is applied gradually in the axial direction until its value reaches 10N (5N for ERH1X).						
		Bending Strength of lead wire terminal (for micro-strip type) Lead wire shall not be cut or broken.	Position the main body of the capacitor so the lead wire terminal is perpendicular, and load 2.5N to the lead wire terminal. Bend the main body by 90 degrees, bend back to original position, bend 90 degrees in the reverse direction, and then bend back to original position.						

Continued on the following page.

Specifications and Test Methods

Continued from the preceding page.

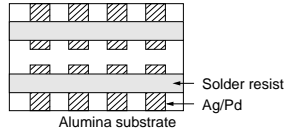
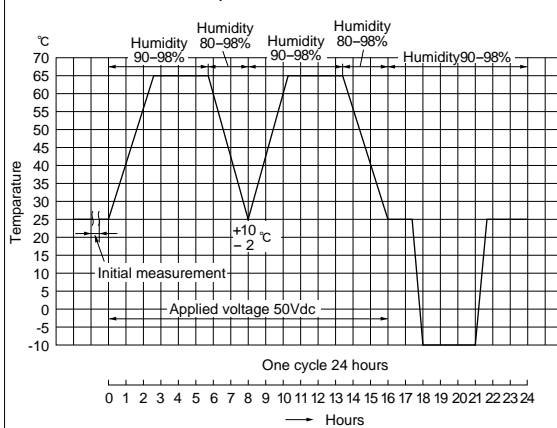
No.	Item	Specification	Test Method																											
11	Appearance	No defects or abnormalities.	Solder the capacitor to the test jig (alumina substrate) shown in Fig.2 using solder containing 2.5% silver. The soldering shall be done either with an iron or using the reflow method and shall be conducted with care so the soldering is uniform and free of defects such as heat shock. The capacitor shall be subjected to a simple harmonic motion having a total amplitude of 1.5mm, the frequency being varied uniformly between the approximate limits of 10 and 55Hz. The frequency range, from 10 to 55Hz and return to 10Hz, shall be traversed in approximately 1 minute. This motion shall be applied for a period of 2 hours in each 3 mutually perpendicular directions (total of 6 hours).																											
	Capacitance	Within the specified tolerance.																												
11	Vibration Resistance	<p>Satisfies the initial value.</p> <p>$C \leq 220\text{pF} : Q \geq 10,000$</p> <p>$220\text{pF} < C \leq 470\text{pF} : Q \geq 5,000$</p> <p>$470\text{pF} < C \leq 1,000\text{pF} : Q \geq 3,000$</p> <p>C : Nominal Capacitance (pF)</p>	 <p>Fig. 2</p>																											
12	Solderability of Termination	95% of the terminations is to be soldered evenly and continuously.	Immerse the capacitor in a solution of ethanol (JIS-K-8101) and rosin (JIS-K-5902) (25% rosin in weight proportion). Preheat at 80 to 120°C for 10 to 30 seconds. After preheating immerse in solder containing 2.5% silver for 5±0.5 seconds at 230±5°C. The dipping depth for microstrip type capacitors is up to 1 mm from the root of the terminal.																											
13	Resistance to Soldering Heat	<p>The measured and observed characteristics shall satisfy the specifications in the following table.</p> <table border="1"> <thead> <tr> <th>Item</th> <th>Specification</th> </tr> </thead> <tbody> <tr> <td>Appearance</td> <td>No marked defect</td> </tr> <tr> <td>Capacitance Change</td> <td>Within ±2.5% or ±0.25pF (Whichever is larger)</td> </tr> <tr> <td>Q</td> <td> $C \leq 220\text{pF} : Q \geq 10,000$ $220\text{pF} < C \leq 470\text{pF} : Q \geq 5,000$ $470\text{pF} < C \leq 1,000\text{pF} : Q \geq 3,000$ </td> </tr> <tr> <td>I.R.</td> <td>More than 30% of the initial specification value at 25°C.</td> </tr> <tr> <td>Dielectric Strength</td> <td>No failure</td> </tr> </tbody> </table> <p>C : Nominal Capacitance (pF)</p>	Item	Specification	Appearance	No marked defect	Capacitance Change	Within ±2.5% or ±0.25pF (Whichever is larger)	Q	$C \leq 220\text{pF} : Q \geq 10,000$ $220\text{pF} < C \leq 470\text{pF} : Q \geq 5,000$ $470\text{pF} < C \leq 1,000\text{pF} : Q \geq 3,000$	I.R.	More than 30% of the initial specification value at 25°C.	Dielectric Strength	No failure	<p>Preheat the capacitor at 80 to 100°C for 2 minutes and then at 150 to 200°C for 5 minutes.</p> <p>Immerse in solder containing 2.5% silver for 3±0.5 seconds at 270±5°C. Set at room temperature for 24±2 hours, then measure. The dipping depth for microstrip type capacitors is up to 2mm from the root of the terminal.</p>															
		Item	Specification																											
Appearance	No marked defect																													
Capacitance Change	Within ±2.5% or ±0.25pF (Whichever is larger)																													
Q	$C \leq 220\text{pF} : Q \geq 10,000$ $220\text{pF} < C \leq 470\text{pF} : Q \geq 5,000$ $470\text{pF} < C \leq 1,000\text{pF} : Q \geq 3,000$																													
I.R.	More than 30% of the initial specification value at 25°C.																													
Dielectric Strength	No failure																													
14	Temperature Cycle	<p>The measured and observed characteristics shall satisfy the specifications in the following table.</p> <table border="1"> <thead> <tr> <th>Item</th> <th>Specification</th> </tr> </thead> <tbody> <tr> <td>Appearance</td> <td>No marked defect</td> </tr> <tr> <td>Capacitance Change</td> <td>Within ±1% or ±0.25pF (Whichever is larger)</td> </tr> <tr> <td>Q</td> <td> $C \leq 220\text{pF} : Q \geq 10,000$ $220\text{pF} < C \leq 470\text{pF} : Q \geq 5,000$ $470\text{pF} < C \leq 1,000\text{pF} : Q \geq 3,000$ </td> </tr> <tr> <td>I.R.</td> <td>More than 30% of the initial specification value at 25°C.</td> </tr> <tr> <td>Dielectric Strength</td> <td>No failure</td> </tr> </tbody> </table> <p>C : Nominal Capacitance (pF)</p>	Item	Specification	Appearance	No marked defect	Capacitance Change	Within ±1% or ±0.25pF (Whichever is larger)	Q	$C \leq 220\text{pF} : Q \geq 10,000$ $220\text{pF} < C \leq 470\text{pF} : Q \geq 5,000$ $470\text{pF} < C \leq 1,000\text{pF} : Q \geq 3,000$	I.R.	More than 30% of the initial specification value at 25°C.	Dielectric Strength	No failure	<p>Fix the capacitor to the supporting jig in the same manner and under the same conditions as (11). Perform the five cycles according to the four heat treatments listed in the following table. Then, repeat twice the successive cycles of immersion, each cycle consisting of immersion in a fresh water at 65±5°C for 15 minutes and immersion in a saturated aqueous solution of salt at 0±3°C for 15 minutes.</p> <table border="1"> <thead> <tr> <th>Step</th> <th>1</th> <th>2</th> <th>3</th> <th>4</th> </tr> </thead> <tbody> <tr> <td>Temp.(°C)</td> <td>-55 ±5</td> <td>RoomTemp.</td> <td>125 ±3</td> <td>RoomTemp.</td> </tr> <tr> <td>Time(min.)</td> <td>30±3</td> <td>2 to 3</td> <td>30±3</td> <td>2 to 3</td> </tr> </tbody> </table> <p>The capacitor is promptly washed with running water, dried with a dry cloth, and allowed to sit at room temperature for 24±2 hours.</p>	Step	1	2	3	4	Temp.(°C)	-55 ±5	RoomTemp.	125 ±3	RoomTemp.	Time(min.)	30±3	2 to 3	30±3	2 to 3
Item	Specification																													
Appearance	No marked defect																													
Capacitance Change	Within ±1% or ±0.25pF (Whichever is larger)																													
Q	$C \leq 220\text{pF} : Q \geq 10,000$ $220\text{pF} < C \leq 470\text{pF} : Q \geq 5,000$ $470\text{pF} < C \leq 1,000\text{pF} : Q \geq 3,000$																													
I.R.	More than 30% of the initial specification value at 25°C.																													
Dielectric Strength	No failure																													
Step	1	2	3	4																										
Temp.(°C)	-55 ±5	RoomTemp.	125 ±3	RoomTemp.																										
Time(min.)	30±3	2 to 3	30±3	2 to 3																										
15	Humidity	<p>The measured and observed characteristics shall satisfy the specifications in the following table.</p> <table border="1"> <thead> <tr> <th>Item</th> <th>Specification</th> </tr> </thead> <tbody> <tr> <td>Appearance</td> <td>No marked defect</td> </tr> <tr> <td>Capacitance Change</td> <td>Within ±5% or ±0.5pF (Whichever is larger)</td> </tr> <tr> <td>Q</td> <td> $C \leq 220\text{pF} : Q \geq 10,000$ $220\text{pF} < C \leq 470\text{pF} : Q \geq 5,000$ $470\text{pF} < C \leq 1,000\text{pF} : Q \geq 3,000$ </td> </tr> <tr> <td>I.R.</td> <td>More than 30% of the initial specification value at 25°C.</td> </tr> </tbody> </table> <p>C : Nominal Capacitance (pF)</p>	Item	Specification	Appearance	No marked defect	Capacitance Change	Within ±5% or ±0.5pF (Whichever is larger)	Q	$C \leq 220\text{pF} : Q \geq 10,000$ $220\text{pF} < C \leq 470\text{pF} : Q \geq 5,000$ $470\text{pF} < C \leq 1,000\text{pF} : Q \geq 3,000$	I.R.	More than 30% of the initial specification value at 25°C.	<p>Apply the 24-hour heat (-10 to +65°C) and humidity (80 to 98%) treatment shown below, 10 consecutive times. Remove, set for 24±2 hours at room temperature, and measure.</p> 																	
		Item	Specification																											
Appearance	No marked defect																													
Capacitance Change	Within ±5% or ±0.5pF (Whichever is larger)																													
Q	$C \leq 220\text{pF} : Q \geq 10,000$ $220\text{pF} < C \leq 470\text{pF} : Q \geq 5,000$ $470\text{pF} < C \leq 1,000\text{pF} : Q \geq 3,000$																													
I.R.	More than 30% of the initial specification value at 25°C.																													

Continued on the following page.

Specifications and Test Methods

 Continued from the preceding page.

No.	Item	Specification	Test Method										
16	High Temperature Load	The measured and observed characteristics shall satisfy the specifications in the following table.	Apply 150% of the rated voltage for 2,000±12 hours at 125±3°C. Remove and set for 24±2 hours at room temperature, then measure. The charge/discharge current is less than 50mA.										
		<table border="1" style="width: 100%; border-collapse: collapse;"> <thead> <tr> <th style="width: 50%;">Item</th> <th style="width: 50%;">Specification</th> </tr> </thead> <tbody> <tr> <td>Appearance</td> <td>No marked defect</td> </tr> <tr> <td>Capacitance Change</td> <td>Within ±2.5% or ±0.25pF (Whichever is larger)</td> </tr> <tr> <td>Q</td> <td>C ≤ 220pF : Q ≥ 10,000 220pF < C ≤ 470pF : Q ≥ 5,000 470pF < C ≤ 1,000pF : Q ≥ 3,000</td> </tr> <tr> <td>I.R.</td> <td>More than 30% of the initial specification value at 25°C.</td> </tr> </tbody> </table>		Item	Specification	Appearance	No marked defect	Capacitance Change	Within ±2.5% or ±0.25pF (Whichever is larger)	Q	C ≤ 220pF : Q ≥ 10,000 220pF < C ≤ 470pF : Q ≥ 5,000 470pF < C ≤ 1,000pF : Q ≥ 3,000	I.R.	More than 30% of the initial specification value at 25°C.
		Item		Specification									
		Appearance		No marked defect									
		Capacitance Change		Within ±2.5% or ±0.25pF (Whichever is larger)									
Q	C ≤ 220pF : Q ≥ 10,000 220pF < C ≤ 470pF : Q ≥ 5,000 470pF < C ≤ 1,000pF : Q ≥ 3,000												
I.R.	More than 30% of the initial specification value at 25°C.												
C : Nominal Capacitance (pF)													

Table A

Char. Code	Temp. Coeff. (ppm/°C) Note 1	Capacitance Change from 25°C Value (%)					
		-55°C		-30°C		-10°C	
		Max.	Min.	Max.	Min.	Max.	Min.
5C	0±30	0.58	-0.24	0.40	-0.17	0.25	-0.11

Note 1 : Nominal values denote the temperature coefficient within a range of 25 to 125°C.

Chip Monolithic Ceramic Capacitors



High Frequency Type

■ Features(ERA Series)

1. Negligible inductance is achieved by its monolithic structure so the series can be used at frequencies above 1GHz.
2. Nickel barriered terminations of ERA series improve solderability and decrease solder leaching.
3. ERA11A/21A series are designed for both flow and reflow soldering and ERA32 series are designed for reflow soldering.

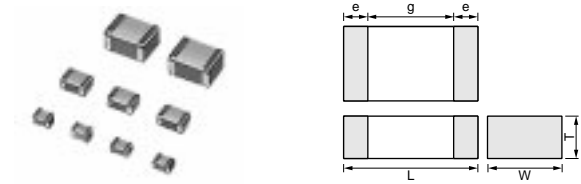

Part Number	Dimensions (mm)				
	L	W	T max.	e	g min.
ERA11A	1.25 ^{+0.5} _{-0.3}	1.0 ^{+0.5} _{-0.3}	1.0±0.2	0.15 min.	0.3
ERA21A ERA21B	2.0 ^{+0.5} _{-0.3}	1.25 ^{+0.5} _{-0.3}	1.0±0.2 1.25±0.2	0.2 max.	0.5
ERA32X	3.2 ^{+0.6} _{-0.4}	2.5 ^{+0.5} _{-0.3}	1.7±0.2	0.3 max.	0.5

■ Applications

High-frequency and high-power circuits.

■ Features(ERD Series)

1. Negligible inductance is achieved by its monolithic structure so the series can be used at frequencies above 1GHz.
2. ERD Series capacitors withstand at high temperatures because ribbon leads are attached with silver paste.
3. ERD Series capacitors are easily soldered and are especially well suited in applications where only a soldering iron can be used.

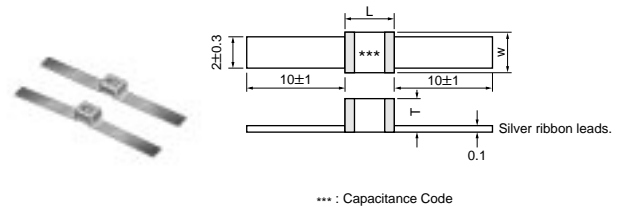

Part Number	Dimensions (mm)		
	L max.	W max.	T max.
ERD32D	4.0	3.0	2.3

■ Application

High-frequency and high-power circuits.

Part Number	ERA11			ERA21			ERA32			ERD32		
L x W	1.25x1.00			2.00x1.25			3.20x2.50			4.00x3.00		
TC	COG (5C)			COG (5C)			COG (5C)			COG (5C)		
Rated Volt.	50 (1H)	100 (2A)	200 (2D)	50 (1H)	100 (2A)	200 (2D)	50 (1H)	100 (2A)	200 (2D)	50 (1H)	100 (2A)	200 (2D)
Capacitance and T Dimension												
0.5pF(R50)			1.00(A)			1.00(A)			1.70(X)			2.30(D)
0.6pF(R60)			1.00(A)			1.00(A)			1.70(X)			2.30(D)
0.7pF(R70)			1.00(A)			1.00(A)			1.70(X)			2.30(D)
0.8pF(R80)			1.00(A)			1.00(A)			1.70(X)			2.30(D)
0.9pF(R90)			1.00(A)			1.00(A)			1.70(X)			2.30(D)
1.0pF(1R0)			1.00(A)			1.00(A)			1.70(X)			2.30(D)
1.1pF(1R1)			1.00(A)			1.00(A)			1.70(X)			2.30(D)
1.2pF(1R2)			1.00(A)			1.00(A)			1.70(X)			2.30(D)
1.3pF(1R3)			1.00(A)			1.00(A)			1.70(X)			2.30(D)
1.4pF(1R4)			1.00(A)			1.00(A)			1.70(X)			2.30(D)
1.5pF(1R5)			1.00(A)			1.00(A)			1.70(X)			2.30(D)
1.6pF(1R6)			1.00(A)			1.00(A)			1.70(X)			2.30(D)
1.7pF(1R7)			1.00(A)			1.00(A)			1.70(X)			2.30(D)
1.8pF(1R8)			1.00(A)			1.00(A)			1.70(X)			2.30(D)
1.9pF(1R9)			1.00(A)			1.00(A)			1.70(X)			2.30(D)
2.0pF(2R0)			1.00(A)			1.00(A)			1.70(X)			2.30(D)
2.1pF(2R1)			1.00(A)			1.00(A)			1.70(X)			2.30(D)

Continued on the following page.

 Continued from the preceding page.

Part Number	ERA11			ERA21			ERA32			ERD32		
L x W	1.25x1.00			2.00x1.25			3.20x2.50			4.00x3.00		
TC	COG (5C)			COG (5C)			COG (5C)			COG (5C)		
Rated Volt.	50 (1H)	100 (2A)	200 (2D)	50 (1H)	100 (2A)	200 (2D)	50 (1H)	100 (2A)	200 (2D)	50 (1H)	100 (2A)	200 (2D)
Capacitance and T Dimension												
2.2pF(2R2)			1.00(A)			1.00(A)			1.70(X)			2.30(D)
2.4pF(2R4)			1.00(A)			1.00(A)			1.70(X)			2.30(D)
2.7pF(2R7)			1.00(A)			1.00(A)			1.70(X)			2.30(D)
3.0pF(3R0)			1.00(A)			1.00(A)			1.70(X)			2.30(D)
3.3pF(3R3)			1.00(A)			1.00(A)			1.70(X)			2.30(D)
3.6pF(3R6)			1.00(A)			1.00(A)			1.70(X)			2.30(D)
3.9pF(3R9)			1.00(A)			1.00(A)			1.70(X)			2.30(D)
4.3pF(4R3)			1.00(A)			1.00(A)			1.70(X)			2.30(D)
4.7pF(4R7)			1.00(A)			1.00(A)			1.70(X)			2.30(D)
5.1pF(5R1)			1.00(A)			1.00(A)			1.70(X)			2.30(D)
5.6pF(5R6)			1.00(A)			1.00(A)			1.70(X)			2.30(D)
6.2pF(6R2)			1.00(A)			1.00(A)			1.70(X)			2.30(D)
6.8pF(6R8)			1.00(A)			1.00(A)			1.70(X)			2.30(D)
7.5pF(7R5)			1.00(A)			1.00(A)			1.70(X)			2.30(D)
8.2pF(8R2)			1.00(A)			1.25(B)			1.70(X)			2.30(D)
9.1pF(9R1)			1.00(A)			1.25(B)			1.70(X)			2.30(D)
10pF(100)			1.00(A)			1.25(B)			1.70(X)			2.30(D)
11pF(110)			1.00(A)			1.25(B)			1.70(X)			2.30(D)
12pF(120)			1.00(A)			1.25(B)			1.70(X)			2.30(D)
13pF(130)			1.00(A)			1.25(B)			1.70(X)			2.30(D)
15pF(150)		1.00(A)				1.25(B)			1.70(X)			2.30(D)
16pF(160)		1.00(A)				1.25(B)			1.70(X)			2.30(D)
18pF(180)		1.00(A)				1.25(B)			1.70(X)			2.30(D)
20pF(200)		1.00(A)				1.25(B)			1.70(X)			2.30(D)
22pF(220)		1.00(A)				1.25(B)			1.70(X)			2.30(D)
24pF(240)	1.00(A)					1.25(B)			1.70(X)			2.30(D)
27pF(270)	1.00(A)					1.25(B)			1.70(X)			2.30(D)
30pF(300)	1.00(A)					1.25(B)			1.70(X)			2.30(D)
33pF(330)	1.00(A)					1.25(B)			1.70(X)			2.30(D)
36pF(360)	1.00(A)					1.25(B)			1.70(X)			2.30(D)
39pF(390)	1.00(A)					1.25(B)			1.70(X)			2.30(D)
43pF(430)	1.00(A)					1.25(B)			1.70(X)			2.30(D)
47pF(470)	1.00(A)					1.25(B)			1.70(X)			2.30(D)
51pF(510)	1.00(A)					1.25(B)			1.70(X)			2.30(D)
56pF(560)						1.25(B)			1.70(X)			2.30(D)
62pF(620)						1.25(B)			1.70(X)			2.30(D)
68pF(680)						1.25(B)			1.70(X)			2.30(D)
75pF(750)						1.25(B)			1.70(X)			2.30(D)
82pF(820)						1.25(B)			1.70(X)			2.30(D)
91pF(910)						1.25(B)			1.70(X)			2.30(D)
100pF(101)				1.00(A)					1.70(X)			2.30(D)
110pF(111)				1.25(B)					1.70(X)			2.30(D)
120pF(121)				1.25(B)					1.70(X)			2.30(D)
130pF(131)				1.25(B)					1.70(X)			2.30(D)
150pF(151)				1.25(B)					1.70(X)			2.30(D)
160pF(161)				1.25(B)					1.70(X)			2.30(D)
180pF(181)									1.70(X)		2.30(D)	
200pF(201)									1.70(X)		2.30(D)	
220pF(221)									1.70(X)		2.30(D)	
240pF(241)									1.70(X)		2.30(D)	
270pF(271)									1.70(X)		2.30(D)	
300pF(301)									1.70(X)		2.30(D)	

Continued on the following page. 

 Continued from the preceding page.

Part Number	ERA11			ERA21			ERA32			ERD32		
L x W	1.25x1.00			2.00x1.25			3.20x2.50			4.00x3.00		
TC	COG (5C)			COG (5C)			COG (5C)			COG (5C)		
Rated Volt.	50 (1H)	100 (2A)	200 (2D)	50 (1H)	100 (2A)	200 (2D)	50 (1H)	100 (2A)	200 (2D)	50 (1H)	100 (2A)	200 (2D)
Capacitance and T Dimension												
330pF(331)								1.70(X)				2.30(D)
360pF(361)								1.70(X)				2.30(D)
390pF(391)								1.70(X)				2.30(D)
430pF(431)								1.70(X)				2.30(D)
470pF(471)								1.70(X)				2.30(D)
510pF(511)								1.70(X)				2.30(D)
560pF(561)							1.70(X)			2.30(D)		
620pF(621)							1.70(X)			2.30(D)		
680pF(681)							1.70(X)			2.30(D)		
750pF(751)							1.70(X)			2.30(D)		
820pF(821)							1.70(X)			2.30(D)		
910pF(911)							1.70(X)			2.30(D)		
1000pF(102)							1.70(X)			2.30(D)		

The part numbering code is shown in ().
 Dimensions are shown in mm and Rated Voltage in Vdc.

Specifications and Test Methods

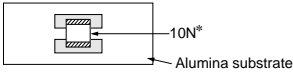
No.	Item	Specification	Test Method									
1	Operating Temperature Range	-55°C to +125°C										
2	Rated Voltage	See the previous pages.	The rated voltage is defined as the maximum voltage which may be applied continuously to the capacitor. When AC voltage is superimposed on DC voltage, V^{P-P} or V^{O-P} , whichever is larger, shall be maintained within the rated voltage range.									
3	Appearance	No defects or abnormalities.	Visual inspection.									
4	Dimensions	Within the specified dimension.	Using calipers.									
5	Dielectric Strength	No defects or abnormalities.	No failure shall be observed when 300% of the rated voltage is applied between the terminations for 1 to 5 seconds, provided the charge/discharge current is less than 50mA.									
6	Insulation Resistance (I.R.)	10,000MΩ min.	The insulation resistance shall be measured with a DC voltage not exceeding the rated voltage at 25°C and standard humidity and within 2 minutes of charging.									
7	Capacitance	Within the specified tolerance.	The capacitance/Q shall be measured at 25°C at the frequency and voltage shown in the table.									
8	Q	$C \leq 220\text{pF} : Q \geq 10,000$ $220\text{pF} < C \leq 470\text{pF} : Q \geq 5,000$ $470\text{pF} < C \leq 1,000\text{pF} : Q \geq 3,000$ C : Nominal Capacitance (pF)	<table border="1" style="width: 100%; border-collapse: collapse;"> <thead> <tr> <th style="width: 30%;">Item \ Char.</th> <th>COG (1,000pF and below)</th> </tr> </thead> <tbody> <tr> <td>Frequency</td> <td>1±0.1MHz</td> </tr> <tr> <td>Voltage</td> <td>0.5 to 5Vr.m.s.</td> </tr> </tbody> </table>	Item \ Char.	COG (1,000pF and below)	Frequency	1±0.1MHz	Voltage	0.5 to 5Vr.m.s.			
			Item \ Char.	COG (1,000pF and below)								
Frequency	1±0.1MHz											
Voltage	0.5 to 5Vr.m.s.											
<table border="1" style="width: 100%; border-collapse: collapse;"> <thead> <tr> <th>Step</th> <th>Temperature(°C)</th> </tr> </thead> <tbody> <tr> <td>1</td> <td>25±2</td> </tr> <tr> <td>2</td> <td>-55±3</td> </tr> <tr> <td>3</td> <td>25±2</td> </tr> <tr> <td>4</td> <td>125±3</td> </tr> <tr> <td>5</td> <td>25±2</td> </tr> </tbody> </table>	Step	Temperature(°C)	1	25±2	2	-55±3	3	25±2	4	125±3	5	25±2
Step	Temperature(°C)											
1	25±2											
2	-55±3											
3	25±2											
4	125±3											
5	25±2											
9	Capacitance Temperature Characteristics	Capacitance Variation Rate	Within the specified tolerance. (Table A-6)									
		Temperature Coefficient	Within the specified tolerance. (Table A-6)									
		Capacitance Drift	Within ±0.2% or ±0.05pF (Whichever is larger)									
10	Terminal Strength	Adhesive Strength of Termination (for chip type)	No removal of the terminations or other defects shall occur. *5N (ERA11) 									
		Tensile Strength (for micro-strip type)	Capacitor shall not be broken or damaged.									
		Bending Strength of lead wire terminal (for micro-strip type)	Lead wire shall not be cut or broken.									

Continued on the following page.

Specifications and Test Methods

Continued from the preceding page.

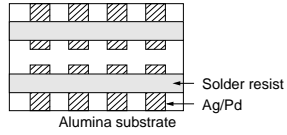
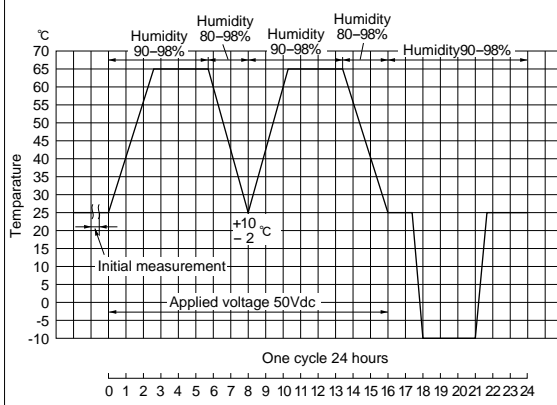
No.	Item	Specification	Test Method																											
11	Appearance	No defects or abnormalities.	Solder the capacitor to the test jig (alumina substrate) shown in Fig.2 using solder containing 2.5% silver. The soldering shall be done either with an iron or using the reflow method and shall be conducted with care so the soldering is uniform and free of defects such as heat shock. The capacitor shall be subjected to a simple harmonic motion having a total amplitude of 1.5mm, the frequency being varied uniformly between the approximate limits of 10 and 55Hz. The frequency range, from 10 to 55Hz and return to 10Hz, shall be traversed in approximately 1 minute. This motion shall be applied for a period of 2 hours in each 3 mutually perpendicular directions (total of 6 hours).																											
	Capacitance	Within the specified tolerance.																												
11	Vibration Resistance	<p>Satisfies the initial value.</p> <p>$C \leq 220\text{pF} : Q \geq 10,000$</p> <p>$220\text{pF} < C \leq 470\text{pF} : Q \geq 5,000$</p> <p>$470\text{pF} < C \leq 1,000\text{pF} : Q \geq 3,000$</p> <p>C : Nominal Capacitance (pF)</p>	 <p>Fig.2</p>																											
12	Solderability of Termination	75% of the terminations is to be soldered evenly and continuously.	Immerse the capacitor in a solution of ethanol (JIS-K-8101) and rosin (JIS-K-5902) (25% rosin in weight proportion). Preheat at 80 to 120°C for 10 to 30 seconds. After preheating immerse in solder containing 2.5% silver for 5±0.5 seconds at 230±5°C. The dipping depth for microstrip type capacitors is up to 1 mm from the root of the terminal.																											
13	Resistance to Soldering Heat	<p>The measured and observed characteristics shall satisfy the specifications in the following table.</p> <table border="1"> <thead> <tr> <th>Item</th> <th>Specification</th> </tr> </thead> <tbody> <tr> <td>Appearance</td> <td>No marked defect</td> </tr> <tr> <td>Capacitance Change</td> <td>Within ±2.5% or ±0.25pF (Whichever is larger)</td> </tr> <tr> <td>Q</td> <td>$C \leq 220\text{pF} : Q \geq 10,000$ $220\text{pF} < C \leq 470\text{pF} : Q \geq 5,000$ $470\text{pF} < C \leq 1,000\text{pF} : Q \geq 3,000$</td> </tr> <tr> <td>Dielectric Strength</td> <td>No failure</td> </tr> </tbody> </table> <p>C : Nominal Capacitance (pF)</p>	Item	Specification	Appearance	No marked defect	Capacitance Change	Within ±2.5% or ±0.25pF (Whichever is larger)	Q	$C \leq 220\text{pF} : Q \geq 10,000$ $220\text{pF} < C \leq 470\text{pF} : Q \geq 5,000$ $470\text{pF} < C \leq 1,000\text{pF} : Q \geq 3,000$	Dielectric Strength	No failure	<p>Preheat according to the conditions listed in the table below. Immerse in solder containing 2.5% silver for 3±0.5 seconds at 270±5°C. Set at room temperature for 24±2 hours, then measure. The dipping depth for microstrip type capacitors is up to 2mm from the root of the terminal.</p> <table border="1"> <thead> <tr> <th>Chip Size</th> <th>Preheat Condition</th> </tr> </thead> <tbody> <tr> <td>2.0×1.25mm max.</td> <td>1minute at 120 to 150°C</td> </tr> <tr> <td>3.2×2.5mm</td> <td>Each 1 minute at 100 to 120°C and then 170 to 200°C</td> </tr> </tbody> </table>	Chip Size	Preheat Condition	2.0×1.25mm max.	1minute at 120 to 150°C	3.2×2.5mm	Each 1 minute at 100 to 120°C and then 170 to 200°C											
		Item	Specification																											
Appearance	No marked defect																													
Capacitance Change	Within ±2.5% or ±0.25pF (Whichever is larger)																													
Q	$C \leq 220\text{pF} : Q \geq 10,000$ $220\text{pF} < C \leq 470\text{pF} : Q \geq 5,000$ $470\text{pF} < C \leq 1,000\text{pF} : Q \geq 3,000$																													
Dielectric Strength	No failure																													
Chip Size	Preheat Condition																													
2.0×1.25mm max.	1minute at 120 to 150°C																													
3.2×2.5mm	Each 1 minute at 100 to 120°C and then 170 to 200°C																													
14	Temperature Cycle	<p>The measured and observed characteristics shall satisfy the specifications in the following table.</p> <table border="1"> <thead> <tr> <th>Item</th> <th>Specification</th> </tr> </thead> <tbody> <tr> <td>Appearance</td> <td>No marked defect</td> </tr> <tr> <td>Capacitance Change</td> <td>Within ±5% or ±0.5pF (Whichever is larger)</td> </tr> <tr> <td>Q</td> <td>$C \geq 30\text{pF} : Q \geq 350$ $10\text{pF} \leq C < 30\text{pF} : Q \geq 275 + \frac{5}{2} C$ $C < 10\text{pF} : Q \geq 200 + 10C$</td> </tr> <tr> <td>I.R.</td> <td>1,000MΩ min.</td> </tr> <tr> <td>Dielectric Strength</td> <td>No failure</td> </tr> </tbody> </table> <p>C : Nominal Capacitance (pF)</p>	Item	Specification	Appearance	No marked defect	Capacitance Change	Within ±5% or ±0.5pF (Whichever is larger)	Q	$C \geq 30\text{pF} : Q \geq 350$ $10\text{pF} \leq C < 30\text{pF} : Q \geq 275 + \frac{5}{2} C$ $C < 10\text{pF} : Q \geq 200 + 10C$	I.R.	1,000MΩ min.	Dielectric Strength	No failure	<p>Fix the capacitor to the supporting jig in the same manner and under the same conditions as (11). Perform the five cycles according to the four heat treatments listed in the following table. Let sit for 24±2 hours at room temperature, then measure.</p> <table border="1"> <thead> <tr> <th>Step</th> <th>1</th> <th>2</th> <th>3</th> <th>4</th> </tr> </thead> <tbody> <tr> <td>Temp.(°C)</td> <td>-55⁺⁰₋₃</td> <td>RoomTemp.</td> <td>125⁺³₋₀</td> <td>RoomTemp.</td> </tr> <tr> <td>Time(min.)</td> <td>30±3</td> <td>2 to 3</td> <td>30±3</td> <td>2 to 3</td> </tr> </tbody> </table>	Step	1	2	3	4	Temp.(°C)	-55 ⁺⁰ ₋₃	RoomTemp.	125 ⁺³ ₋₀	RoomTemp.	Time(min.)	30±3	2 to 3	30±3	2 to 3
Item	Specification																													
Appearance	No marked defect																													
Capacitance Change	Within ±5% or ±0.5pF (Whichever is larger)																													
Q	$C \geq 30\text{pF} : Q \geq 350$ $10\text{pF} \leq C < 30\text{pF} : Q \geq 275 + \frac{5}{2} C$ $C < 10\text{pF} : Q \geq 200 + 10C$																													
I.R.	1,000MΩ min.																													
Dielectric Strength	No failure																													
Step	1	2	3	4																										
Temp.(°C)	-55 ⁺⁰ ₋₃	RoomTemp.	125 ⁺³ ₋₀	RoomTemp.																										
Time(min.)	30±3	2 to 3	30±3	2 to 3																										
15	Humidity	<p>The measured and observed characteristics shall satisfy the specifications in the following table.</p> <table border="1"> <thead> <tr> <th>Item</th> <th>Specification</th> </tr> </thead> <tbody> <tr> <td>Appearance</td> <td>No marked defect</td> </tr> <tr> <td>Capacitance Change</td> <td>Within ±5% or ±0.5pF (Whichever is larger)</td> </tr> <tr> <td>Q</td> <td>$C \geq 30\text{pF} : Q \geq 350$ $10\text{pF} \leq C < 30\text{pF} : Q \geq 275 + \frac{5}{2} C$ $C < 10\text{pF} : Q \geq 200 + 10C$</td> </tr> <tr> <td>I.R.</td> <td>1,000MΩ min.</td> </tr> </tbody> </table> <p>C : Nominal Capacitance (pF)</p>	Item	Specification	Appearance	No marked defect	Capacitance Change	Within ±5% or ±0.5pF (Whichever is larger)	Q	$C \geq 30\text{pF} : Q \geq 350$ $10\text{pF} \leq C < 30\text{pF} : Q \geq 275 + \frac{5}{2} C$ $C < 10\text{pF} : Q \geq 200 + 10C$	I.R.	1,000MΩ min.	<p>Apply the 24-hour heat (-10 to +65°C) and humidity (80 to 98%) treatment shown below, 10 consecutive times. Remove, set for 24±2 hours at room temperature, and measure.</p> 																	
		Item	Specification																											
Appearance	No marked defect																													
Capacitance Change	Within ±5% or ±0.5pF (Whichever is larger)																													
Q	$C \geq 30\text{pF} : Q \geq 350$ $10\text{pF} \leq C < 30\text{pF} : Q \geq 275 + \frac{5}{2} C$ $C < 10\text{pF} : Q \geq 200 + 10C$																													
I.R.	1,000MΩ min.																													

Continued on the following page. ↗

Specifications and Test Methods

 Continued from the preceding page.

No.	Item	Specification	Test Method	
16	High Temperature Load	The measured and observed characteristics shall satisfy the specifications in the following table.	Apply 200% of the rated voltage for 1,000±12 hours at 125±3°C. Remove and set for 24±2 hours at room temperature, then measure. The charge/discharge current is less than 50mA.	
		Item		Specification
		Appearance		No marked defect
		Capacitance Change		Within ±3% or ±0.3pF (Whichever is larger)
		Q		$C \geq 30\text{pF} : Q \geq 350$ $10\text{pF} \leq C < 30\text{pF} : Q \geq 275 + \frac{C}{2}$ $C < 10\text{pF} : Q \geq 200 + 10C$
I.R.	1,000MΩ min.			
C : Nominal Capacitance (pF)				

Table A

Char. Code	Temperature Coefficient (ppm/°C) Note 1	Capacitance Change from 25°C Value (%)					
		-55°C		-30°C		-10°C	
		Max.	Min.	Max.	Min.	Max.	Min.
5C	0±30	0.58	-0.24	0.40	-0.17	0.25	-0.11

Note 1 : Nominal values denote the temperature coefficient within a range of 25 to 125°C.

ERF/ERH/ERA/ERD Series Data

Q-Frequency Characteristics

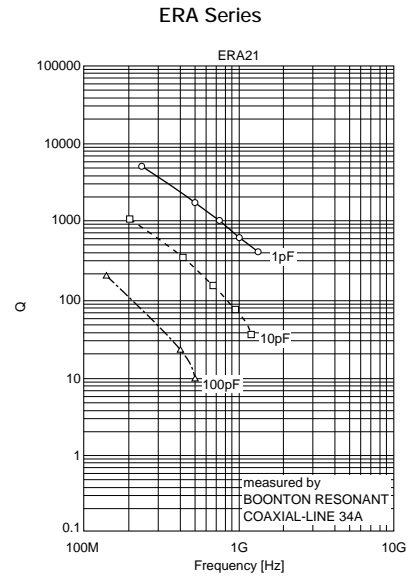
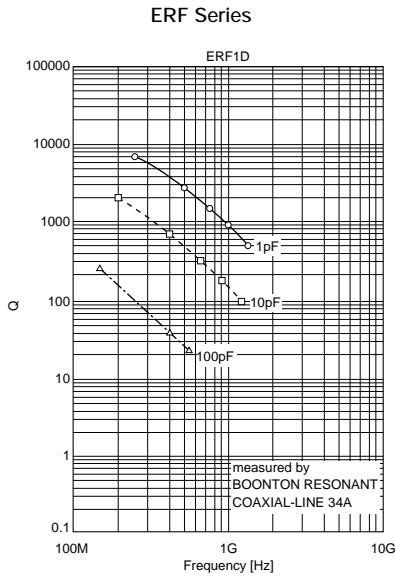

Impedance-Frequency Characteristics

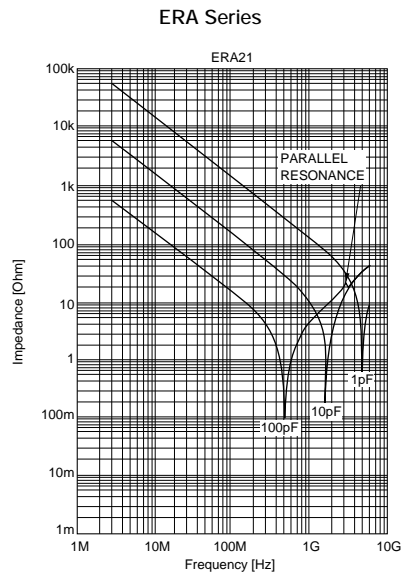
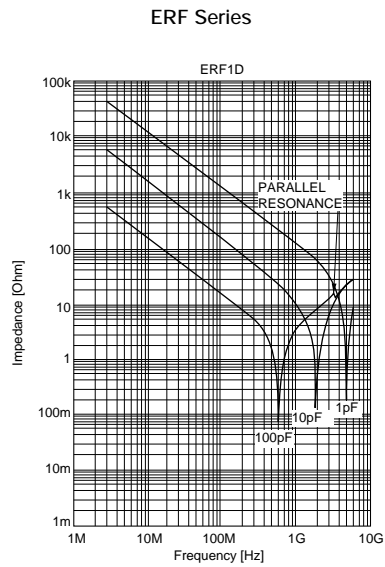

ESR-Frequency Characteristics

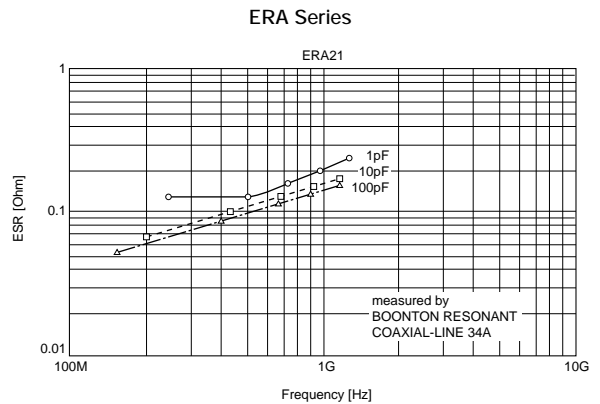
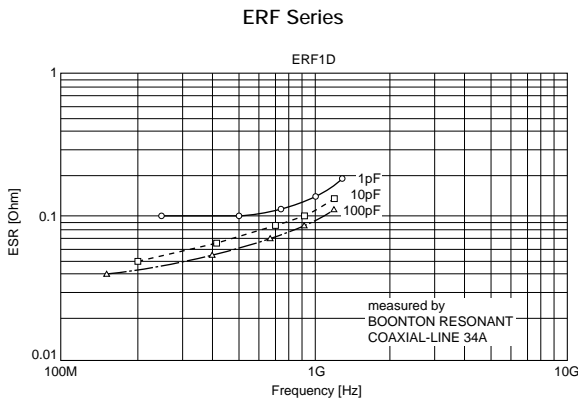

Continued on the following page.

ERF/ERH/ERA/ERD Series Data

Continued from the preceding page.

Resonant Frequency-Capacitance

ERF Series

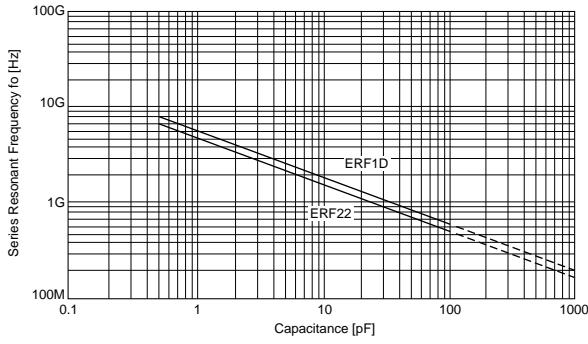

ERA Series

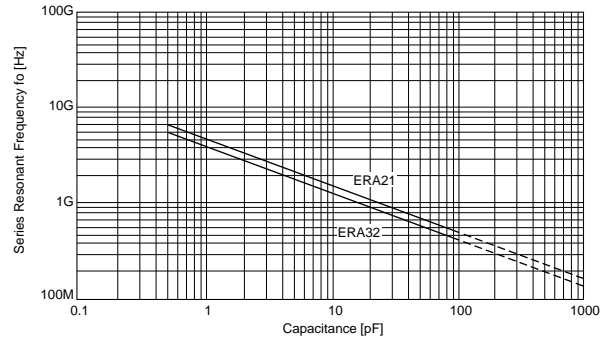

Allowable Voltage-Frequency

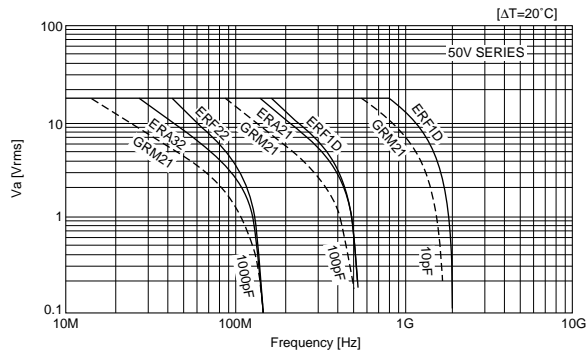

Allowable Current-Frequency

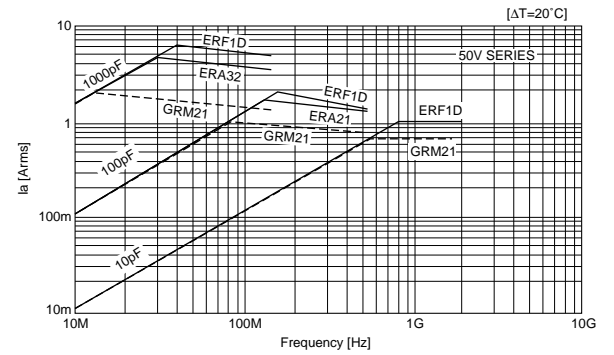

Allowable Apparent Power-Frequency

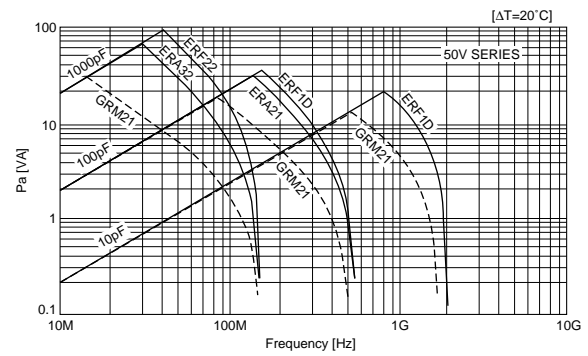

Allowable Effective Power-Frequency

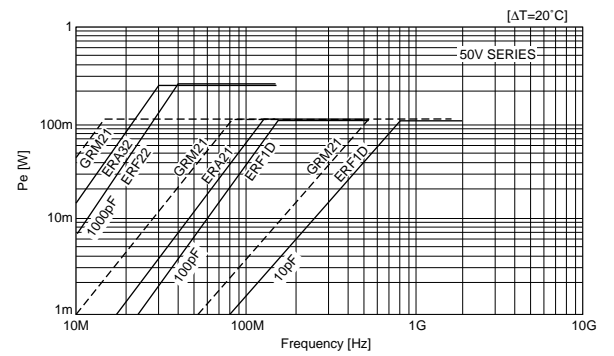

Package

■ Packaging Code

Packaging Type	Tape Carrier Packaging	Bulk Case Packaging	Bulk Packaging	
			Bulk Packaging in a bag	Bulk Packaging in a tray
Packaging Code	D, L, K, J, E, F	C	B	T

■ Minimum Quantity Guide

Part Number		Dimensions (mm)			Quantity (pcs.)					
					φ180mm reel		φ330mm reel		Bulk Case	Bulk Bag
		L	W	T	Paper Tape	Plastic Tape	Paper Tape	Plastic Tape		
Ultra-miniaturized	GRP03	0.6	0.3	0.3	15,000	-	-	-	-	1,000
For Flow/Reflow	GRM18	1.6	0.8	0.8	4,000	-	10,000	-	15,000	1,000
	GRM21	2.0	1.25	0.6	4,000	-	10,000	-	10,000	1,000
				0.85	4,000	-	10,000	-	-	1,000
				1.25	-	3,000	-	10,000	5,000	1,000
	GRM31	3.2	1.6	0.85	4,000	-	10,000	-	-	1,000
				1.15	-	3,000	-	10,000	-	1,000
1.6				-	2,000	-	6,000	-	1,000	
For Reflow	GRP155	1.0	0.5	0.5	10,000	-	50,000	-	50,000	1,000
	GRP15X	1.0	0.5	0.25	10,000	-	50,000	-	-	1,000
	GRM32	3.2	2.5	1.15	-	3,000	-	10,000	-	1,000
				1.35	-	2,000	-	8,000	-	1,000
				1.8	-	1,000	-	4,000	-	1,000
				2.5	-	1,000	-	4,000	-	1,000
	GRM43	4.5	3.2	2.0	-	1,000	-	4,000 ²⁾	-	1,000
GRM55	5.7	5.0	2.0	-	1,000	-	4,000 ²⁾	-	1,000	
High-power Type	GJ615	1.0	0.5	0.5	10,000	-	50,000	-	50,000	1,000
Smoothing ¹⁾	GJ221	2.0	1.25	1.25	-	3,000	-	10,000	-	-
	GJ231	3.2	1.6	1.15	-	3,000	-	10,000	-	-
				1.35	-	2,000	-	8,000	-	-
	GJ232	3.2	2.5	1.6	-	2,000	-	6,000	-	-
				1.8	-	1,000	-	4,000	-	-
				2.0	-	1,000	-	3,000	-	-
GJ243	4.5	3.2	2.5	-	500	-	2,000	-	-	
High-frequency	GQM18	1.6	0.8	0.8	4,000	-	10,000	-	-	1,000
	GQM21	2.0	1.25	1.0	4,000	-	10,000	-	-	1,000
	ERA11	1.25	1.0	1.2	-	-	-	-	-	1,000
	ERA21	2.0	1.25	1.45	-	3,000	-	-	-	1,000
	ERA32	3.2	2.5	1.9	-	2,000	-	-	-	1,000
	ERF1D	1.4	1.4	1.65	-	2,000	-	-	-	1,000
	ERF22	2.8	2.8	2.8	-	1,000	-	-	-	1,000
For Ultrasonic	GRM21	2.0	1.25	0.85	4,000	-	10,000	-	-	1,000
Micro Chip	GMA05	0.5	0.5	0.35	-	-	-	-	-	400 ³⁾
	GMA08	0.8	0.8	0.5	-	-	-	-	-	400 ³⁾
Array	GNM31	3.2	1.6	0.8	4,000	-	10,000	-	-	1,000
				1.0	-	3,000	-	10,000	-	1,000
Low ESL	LLL18	0.8	1.6	0.6	4,000	-	10,000	-	-	1,000
	LLL21	1.25	2.0	1.0	-	4,000 ⁴⁾	-	10,000	-	1,000
				0.7	-	4,000	-	10,000	-	1,000
	LLL31	1.6	3.2	1.25	-	3,000	-	10,000	-	1,000

1) Smoothing rated are available by taping packages only.

2) Depending on capacitance, some products are supplied on the 5,000pcs./reel basis.

3) Tray

4) Depending on capacitance, some products are supplied on the 3,000 pcs./reel basis.

Continued on the following page. 

Package

Continued from the preceding page.

(3) Dimensions of Plastic Tape

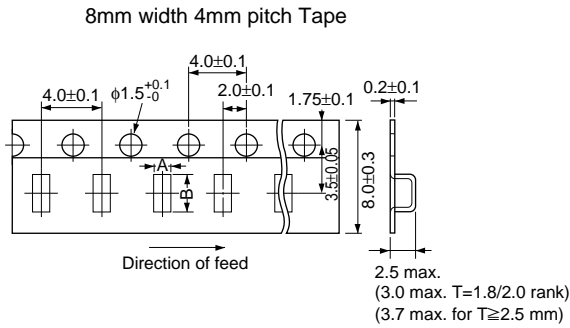

Part Number	A	B
LLL18	1.05±0.1	1.85±0.1
GRM21 (T=1.25mm) LLL21, GJ221	1.45±0.2	2.25±0.2
GRM31 (T≥1.15mm) LLL31 GNM31 (T≥1.0mm) GJ231	1.9±0.2	3.5±0.2
GRM32 (T≥1.15mm) GJ232	2.8±0.2	3.5±0.2
ERA21	1.8*	2.6*
ERA32	2.8*	3.5*
ERE1D	2.0*	2.1*
ERE22	3.1*	3.2*

*Nominal Value

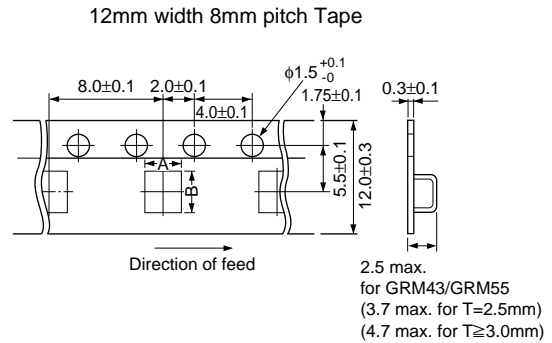

Part Number	A*	B*
GRM43, GJ243	3.6	4.9
GRM55	5.2	6.1

*Nominal Value

(in mm)

(4) Taping Method

- ① Tapes for capacitors are wound clockwise. The sprocket holes are to the right as the tape is pulled toward the user.
- ② Part of the leader and part of the empty tape shall be attached to the end of the tape as follows.
- ③ The top tape and base tape are not attached at the end of the tape for a minimum of 5 pitches.
- ④ Missing capacitors number within 0.1% of the number per reel or 1 pc, whichever is greater, and are not continuous.
- ⑤ The top tape and bottom tape shall not protrude beyond the edges of the tape and shall not cover sprocketed holes.
- ⑥ Cumulative tolerance of sprocket holes, 10 pitches : ±0.3mm.
- ⑦ Peeling off force : 0.1 to 0.6N* in the direction shown below. *GRP03:0.05 to 0.5N

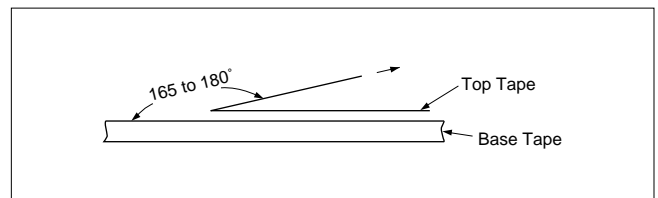
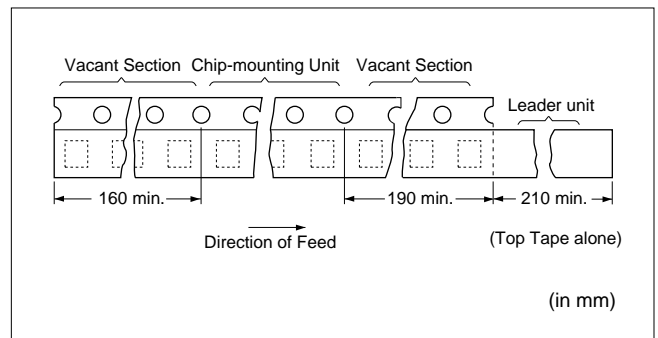

Continued on the following page.

Package

Continued from the preceding page.

■ Dimensions of Bulk Case Packaging

The bulk case used antistatic materials. Please contact Murata for details.

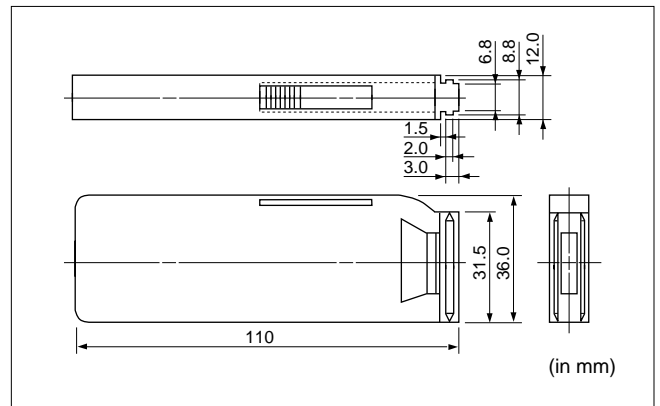

Notice

■ Storage and Operating Conditions

Chip monolithic ceramic capacitors (chips) can experience degradation of termination solderability when subjected to high temperature or humidity, or if exposed to sulfur or chlorine gases.

Storage environment must be at an ambient temperature of 5-40 C. and an ambient humidity of 20-70%RH.

Use chip within 6 months. If 6 months or more have elapsed, check solderability before use.

(Reference Data 1. Solderability)

■ Rating

Die Bonding/Wire Bonding (GMA Series)

(1) Die Bonding of Capacitors

- Use the following materials

Braze alloy : Au-Si (98/2) 400 to 420degree C in N2 atmosphere

Au-Sn (80/20) 300 to 320degree C in N2 atmosphere

Au-Ge (88/12) 380 to 400degree C in N2 atmosphere

- Mounting

1. Control the temperature of the substrate so that it matches the temperature of the braze alloy.
2. Place braze alloy on substrate and place the capacitor on the alloy. Hold the capacitor and

gently apply the load. Be sure to complete the operation in 1 minute.

(2) Wire Bonding

- Wire

Gold wire : 20mm (0.0008 inch), 25mm (0.001 inch) diameter

- Bonding

1. Thermocompression, ultrasonic ball bonding.
2. Required stage temperature : 150 to 250degree C
3. Required wedge or capillary weight : 0.5N to 2N.
4. Bond the capacitor and base substrate or other devices with gold wire.

■ Handling

1. Inspection

Thrusting force of the test probe can flex the PCB, resulting in cracked chips or open solder joints. Provide support pins on the back side of the PCB to prevent warping or flexing.

2. Board Separation (or Depanelization)

- Board flexing at the time of separation causes cracked chips or broken solder.
- Severity of stresses imposed on the chip at the time of board break is in the order of : PushbackFSlitterFV SlotFPerforator.
- Board separation must be performed using special jigs, not with hands.

■ Others

1. Resin Coating

When selecting resin materials, select those with low contraction.

2. Circuit Design

These capacitors on this catalog are not safety recognized products

3. Remarks

The above notices are for standard applications and conditions. Contact us when the products are used in special mounting conditions. Select optimum conditions for operation as they determine the reliability of the product after assembly.

The data here in are given in typical values, not guaranteed ratings.

Notice

■ Soldering and Mounting

1. PCB Design

(1) Notice for Pattern Forms

Unlike leaded components, chip components are susceptible to flexing stresses since they are mounted directly on the substrate.

They are also more sensitive to mechanical and thermal stresses than leaded components.

Excess solder fillet height can multiply these stresses and cause chip cracking. When designing substrates, take land patterns and dimensions into consideration to eliminate the possibility of excess solder fillet height.

Pattern Forms

	Placing Close to Chassis	Placing of Chip Components and Leaded Components	Placing of Leaded Components after Chip Component	Lateral Mounting
Incorrect				
Correct				

Continued on the following page.

Notice

Continued from the preceding page.

(2) Land Dimensions

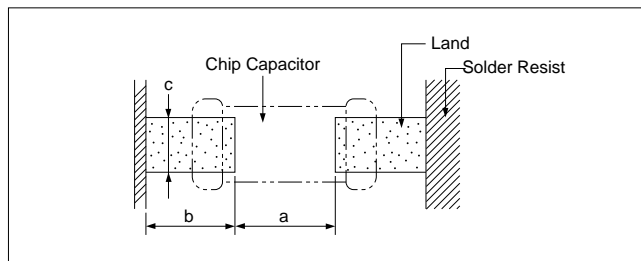

Table 1 Flow Soldering Method

Part Number	Dimensions (L×W)	a	b	c
GRM18 GQM18	1.6×0.8	0.6–1.0	0.8–0.9	0.6–0.8
GRM21 GQM21	2.0×1.25	1.0–1.2	0.9–1.0	0.8–1.1
GRM31	3.2×1.6	2.2–2.6	1.0–1.1	1.0–1.4
LLL21	1.25×2.0	0.4–0.7	0.5–0.7	1.4–1.8
LLL31	1.6×3.2	0.6–1.0	0.8–0.9	2.6–2.8
ERA11	1.25×1.0	0.4–0.6	0.6–0.8	0.8–1.0
ERA21	2.0×1.25	1.0–1.2	0.9–1.0	0.8–1.0
ERE1D	1.4×1.4	0.5–0.8	0.8–0.9	1.0–1.2

(in mm)

Table 2 Reflow Soldering Method

Part Number	Dimensions (L×W)	a	b	c
GRP03	0.6×0.3	0.2–0.3	0.2–0.35	0.2–0.4
GRP15 GJ615	1.0×0.5	0.3–0.5	0.35–0.45	0.4–0.6
GRM18 GQM18	1.6×0.8	0.6–0.8	0.6–0.7	0.6–0.8
GRM21 GQM21 GJ221	2.0×1.25	1.0–1.2	0.6–0.7	0.8–1.1
GRM31 GJ231	3.2×1.6	2.2–2.4	0.8–0.9	1.0–1.4
GRM32 GJ232	3.2×2.5	2.0–2.4	1.0–1.2	1.8–2.3
GRM43 GJ243	4.5×3.2	3.0–3.5	1.2–1.4	2.3–3.0
GRM55	5.7×5.0	4.0–4.6	1.4–1.6	3.5–4.8
LLL18	0.8×1.6	0.2–0.4	0.3–0.4	1.0–1.4
LLL21	1.25×2.0	0.4–0.6	0.3–0.5	1.4–1.8
LLL31	1.6×3.2	0.6–0.8	0.6–0.7	2.6–2.8
ERA11	1.25×1.0	0.4–0.6	0.6–0.8	0.8–1.0
ERA21	2.0×1.25	1.0–1.2	0.6–0.8	0.8–1.0
ERA32	3.2×2.5	2.2–2.5	0.8–1.0	1.9–2.3
ERE1D	1.4×1.4	0.4–0.8	0.6–0.8	1.0–1.2
ERE22	2.8×2.8	1.8–2.1	0.7–0.9	2.2–2.6

(in mm)

Continued on the following page.

Notice

Continued from the preceding page.

● GNM Series for reflow soldering method

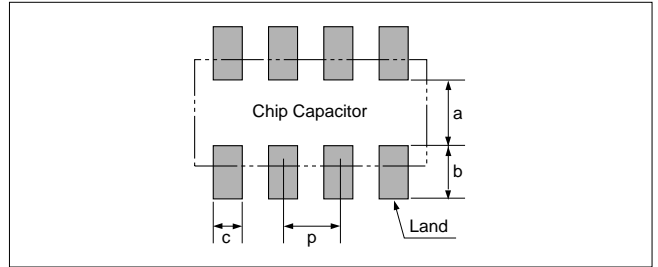
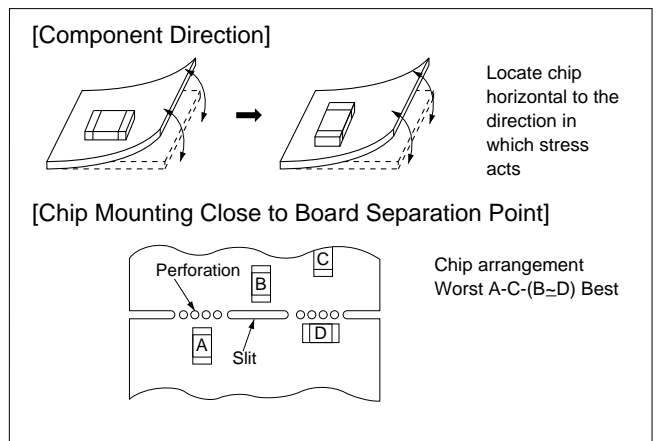

Table 3

Part Number	Dimensions (mm)					
	L	W	a	b	c	p
GNM31	3.2	1.6	0.8–1.0	0.7–0.9	0.3–0.4	0.8

(3) Mounting Position

Choose a mounting position that minimizes the stress imposed on the chip during flexing or bending of the board.



(Reference Data 2. Board bending strength for solder fillet height)
 (Reference Data 3. Temperature cycling for solder fillet height)
 (Reference Data 4. Board bending strength for board material)

2. Solder Paste Printing

- Overly thick application of solder paste results in excessive fillet height solder. This makes the chip more susceptible to mechanical and thermal stress on the board and may cause cracked chips.
- Too little solder paste results in a lack of adhesive strength on the outer electrode, which may result in chips breaking loose from the PCB.
- Make sure the solder has been applied smoothly to the end surface to a height of 0.2mm min.

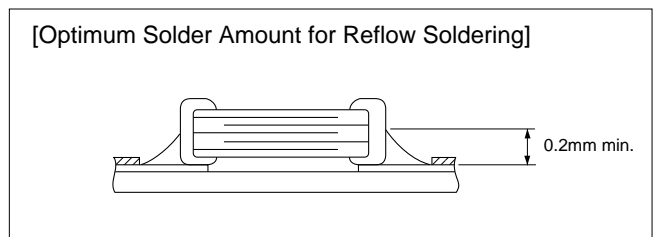

Continued on the following page. ↗

Notice

Continued from the preceding page.

3. Chip Placing

- An excessively low bottom dead point of the suction nozzle imposes great force on the chip during mounting, causing cracked chips. So adjust the suction nozzle's bottom dead point by correcting warp in the board. Normally, the suction nozzle's bottom dead point must be set on the upper surface of the board. Nozzle pressure for chip mounting must be a 1 to 3N static load.
- Dirt particles and dust accumulated between the suction nozzle and the cylinder inner wall prevent the nozzle from moving smoothly. This imposes great force on the chip during mounting, causing cracked chips. And the locating claw, when worn out, imposes uneven forces on the chip when positioning, causing cracked chips. The suction nozzle and the locating claw must be maintained, checked and replaced periodically.
(Reference Data 5. Break strength)

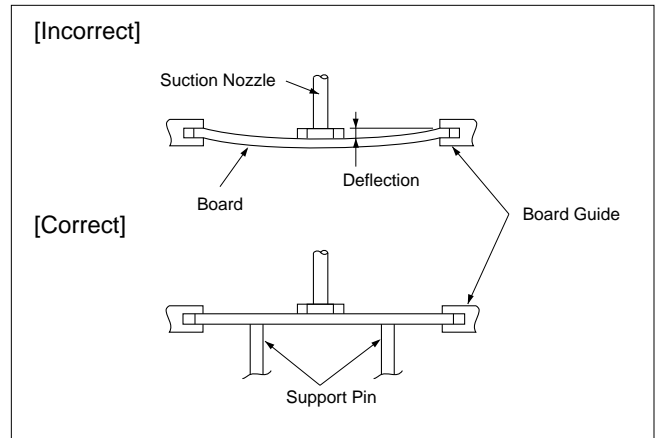

4. Reflow Soldering

- Sudden heating of the chip results in distortion due to excessive expansion and construction forces within the chip causing cracked chips. So when preheating, keep temperature differential, ΔT , within the range shown in Table 4. The smaller the ΔT , the less stress on the chip.
- When components are immersed in solvent after mounting, be sure to maintain the temperature difference (ΔT) between the component and solvent within the range shown in the above table.

Table 4

Part Number	Temperature Differential
GRP03/15, GRM18/21/31 GJ615, GJ221/31 LLL18/21/31 ERA11/21/32 GQM18/21	$\Delta T \leq 190^\circ\text{C}$
GRM32/43/55 GNM31, GJ232/43 ERA32, ERE22	$\Delta T \leq 130^\circ\text{C}$

[Standard Conditions for Reflow Soldering]

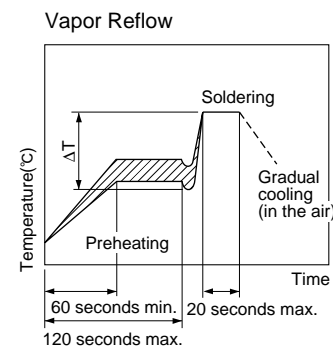
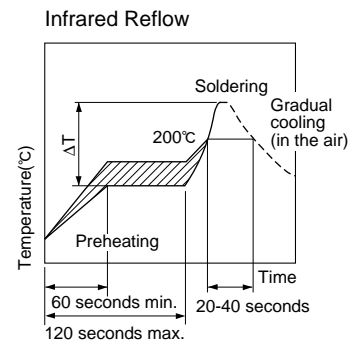

[Allowable Soldering Temperature and Time]

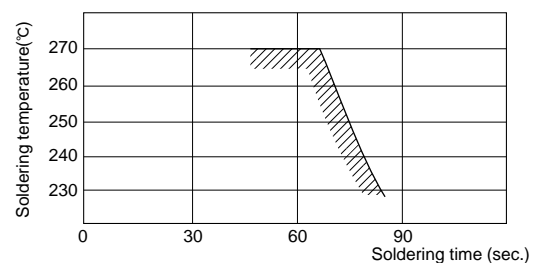

In case of repeated soldering, the accumulated soldering time must be within the range shown above.

Inverting the PCB

Make sure not to impose an abnormal mechanical shock on the PCB.

Continued on the following page.

Notice

Continued from the preceding page.

5. Adhesive Application

- Thin or insufficient adhesive causes chips to loosen or become disconnected when flow soldered. The amount of adhesive must be more than dimension C shown in the drawing below to obtain enough bonding strength. The chip's electrode thickness and land thickness must be taken into consideration.
- Low viscosity adhesive causes chips to slip after mounting. Adhesive must have a viscosity of 5000pa-s (500ps)min. (at 25°C)
- Adhesive Coverage*

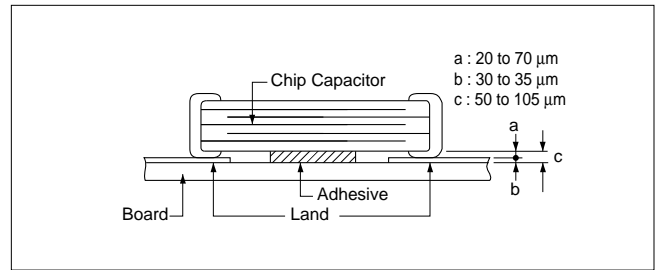

Part Number	Adhesive Coverage*
GRM18 GQM18	0.05mg Min.
GRM21 GQM21	0.1mg Min.
GRM31	0.15mg Min.

*Nominal Value

6. Adhesive Curing

Insufficient curing of the adhesive causes chips to disconnect during flow soldering and causes deteriorated insulation resistance between outer electrodes due to moisture absorption. Control curing temperature and time in order to prevent insufficient hardening.

Inverting the PCB

Make sure not to impose an abnormal mechanical shock on the PCB.

7. Leaded Component Insertion

If the PCB is flexed when leaded components (such as transformers and ICs) are being mounted, chips may crack and solder joints may break. Before mounting leaded components, support the PCB using backup pins or special jigs to prevent warping.

8. Flux Application

- An excessive amount of flux generates a large quantity of flux gas, causing deteriorated solderability. So apply flux thinly and evenly throughout. (A foaming system is generally used for flow soldering).
- Flux containing too high a percentage of halide may cause corrosion of the outer electrodes unless sufficiently cleaned. Use flux with a halide content of 0.2wt% max. But do not use strongly acid flux. Wash thoroughly because water soluble flux causes deteriorated insulation resistance between outer electrodes unless sufficiently cleaned.

Continued on the following page. ↗

Notice

 Continued from the preceding page.

9. Flow Soldering

- Sudden heating of the chip results in thermal distortion causing cracked chips. And an excessively long soldering time or high soldering temperature results in leaching of the outer electrodes, causing poor adhesion or a reduction in capacitance value due to loss of contact between electrodes and end termination.
- When preheating, keep the temperature differential between solder temperature and chip surface temperature, ΔT , within the range shown in Table 5. The smaller the ΔT , the less stress on the chip. When components are immersed in solvent after mounting, be sure to maintain the temperature difference between the component and solvent within the range shown in Table 5. Do not apply flow soldering to chips not listed in Table 5.

Table 5

Part Number	Temperature Differential
GRM18/21/31 LLL21/31 ERA11/21, ERE1D GQM18/21	$\Delta T \leq 150^\circ\text{C}$

- Optimum Solder Amount for Flow Soldering

- Set temperature and time to ensure that leaching of the outer electrode does not exceed 25% of the chip end area as a single chip (full length of the edge A-B-C-D shown below) and 25% of the length A-B shown below as mounted on substrate.

(Reference Data 6. Thermal shock)
(Reference Data 7. Solder heat resistance)

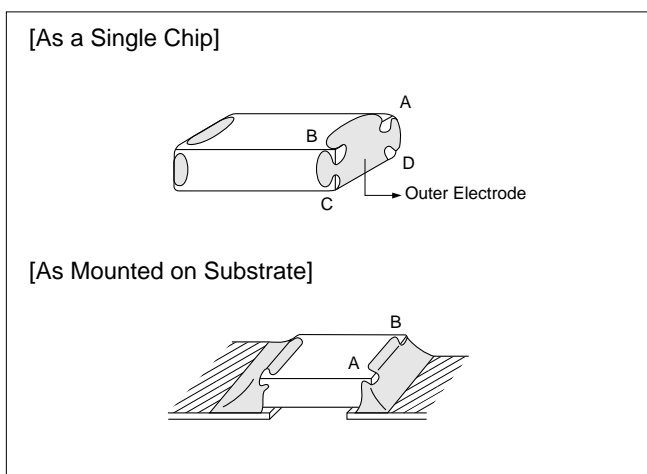
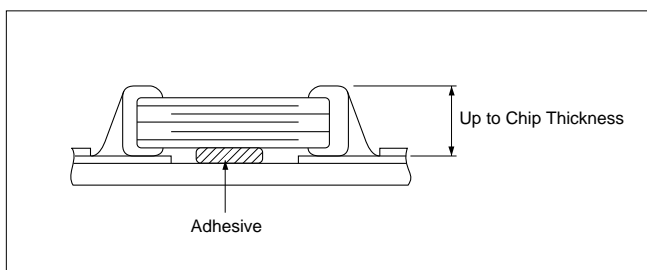
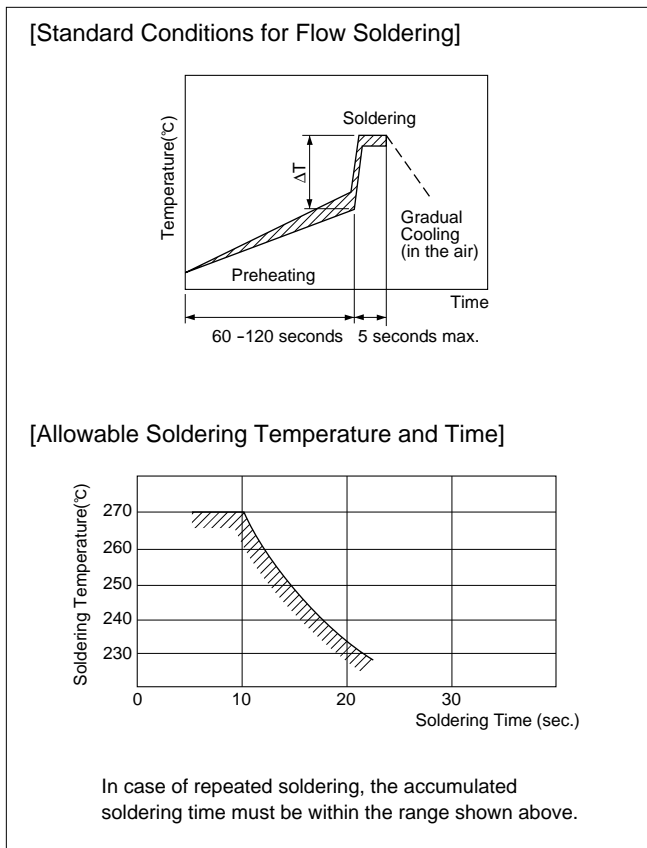

Continued on the following page. 

Notice

Continued from the preceding page.

10. Correction with a Soldering Iron

(1) For Chip Type Capacitors <Except GJ2 Series>

- Sudden heating of the chip results in distortion due to a high internal temperature differential, causing cracked chips. When preheating, keep temperature differential, ΔT , within the range shown in Table 6. The smaller the ΔT , the less stress on the chip.

Table 6

Part Number	Temperature Differential
GRP15, GRM18/21/31 GJ615 LLL18/21/31 GQM18/21 ERA11/21, ERE1D	$\Delta T \leq 190^\circ\text{C}$
GRM32/43/55 GNM31 ERA32, ERE22	$\Delta T \leq 130^\circ\text{C}$

[Standard Conditions for Soldering Iron Temperature]

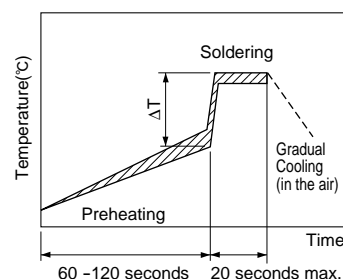

[Allowable Time and Temperature for Making Corrections with a Soldering Iron]

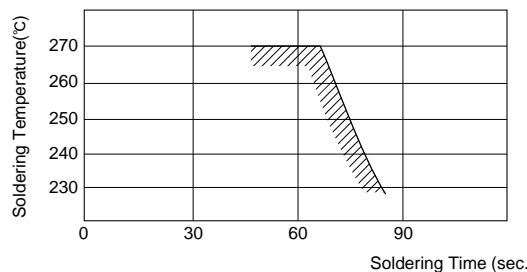

The accumulated soldering Time / temperature including reflow / flow soldering must be within the range shown above.

- Optimum Solder Amount when Corrections Are Made Using a Soldering Iron

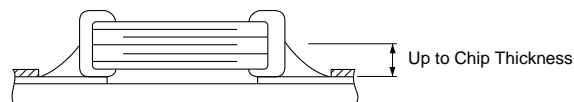

- When correcting chips with a soldering iron, no preheating is required if the chip is listed in Table 7 and the following conditions (Table 7) are met.

Preheating should be performed on chips not listed in Table 7.

(Reference Data 8. Thermal shock when making a correction with a soldering iron)

Table 7 Correction with a Soldering Iron

Part Number	Temperature of Iron Tip	Soldering Iron Wattage	Diameter of Iron Tip	Restriction
GRP15, GRM18/21 GJ615 LLL18/21 GQM18/21 ERA11/21, ERE1D	300°C max.	20W max.	φ 3mm max.	Do not allow the iron tip to directly touch the ceramic element.
GRM31 LLL31 GNM31	270°C max.			

Continued on the following page. ↗

Notice

 Continued from the preceding page.

(2) For GJ2 Series

● When solder GJ2 series chip capacitor, keep the following conditions.

<Soldering iron method>

Part Number	Pre-heating	Temperature of iron tip	Soldering iron wattage	Diameter of iron tip	Soldering time	Soldering amount	Restriction
GJ221/31/32/43	$\Delta \leq 130^{\circ}\text{C}$	300°C max.	20W max.	ϕ 3mm max.	5 sec. max.	$\leq 1/2$ of chip thickness	Do not allow the iron tip to directly touch the ceramic element.

(3) For Microstrip Types

- Solder 1mm away from the ribbon terminal base, being careful that the solder tip does not directly contact the capacitor. Preheating is unnecessary.
- Complete soldering within 3 seconds with a soldering tip less than 270°C in temperature.

11. Washing

Excessive output of ultrasonic oscillation during cleaning causes PCBs to resonate, resulting in cracked chips or broken solder. Take note not to vibrate PCBs.

Reference Data

1. Solderability

(1) Test Method

Subject the chip capacitor to the following conditions.
Then apply flux (a ethanol solution of 25% rosin) to the chip and dip it in 230°C eutectic solder for 2 seconds.

Conditions :

Expose prepared at room temperature (for 6 months and 12 months, respectively)

Prepared at high temperature (for 100 hours at 85°C)

Prepared left at high humidity (for 100 hours under 90%RH to 95%RH at 40°C)

(2) Test Samples

GRM21 : Products for flow/reflow soldering.

(3) Acceptance Criteria

With a 60-power optical microscope, measure the surface area of the outer electrode that is covered with solder.

(4) Results

Refer to Table 1.

Table 1

Sample	Initial State	Prepared at Room Temperature		Prepared at High Temperature for 100 Hours at 85°C	Prepared at High Humidity for 100 Hours at 90 to 95% RH and 40°C
		6 months	12 months		
GRM21 for flow/reflow soldering	95 to 100%	95 to 100%	95%	90 to 95%	95%

2. Board Bending Strength for Solder Fillet Height

(1) Test Method

Solder the chip capacitor to the test PCB with the amount of solder paste necessary to achieve the fillet heights.

Then bend the PCB using the method illustrated and measure capacitance.

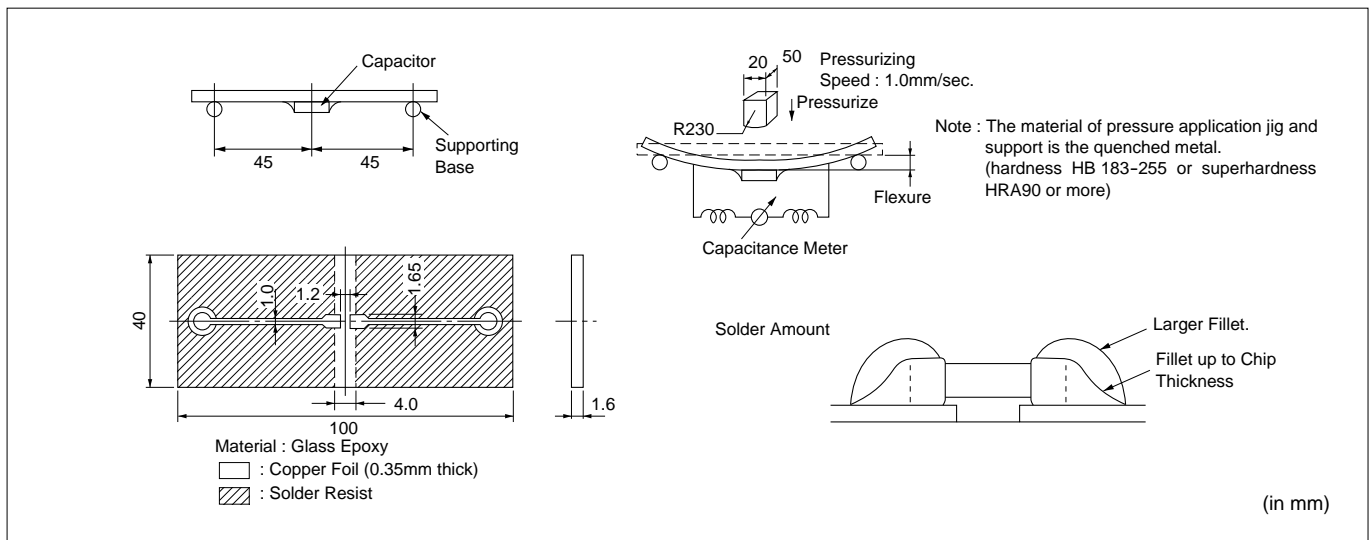

(2) Test Samples

GRM21 C0G/X7R/Y5V Characteristics T=0.6mm

(3) Acceptance Criteria

Products shall be determined to be defective if the change in capacitance has exceeded the values specified in Table 2.

Table 2

Characteristics	Change in Capacitance
C0G	Within $\pm 5\%$ or $\pm 0.5\text{pF}$, whichever is greater
X7R	Within $\pm 12.5\%$
Y5V	Within $\pm 20\%$

Continued on the following page.

Reference Data

Continued from the preceding page.

(4) Results

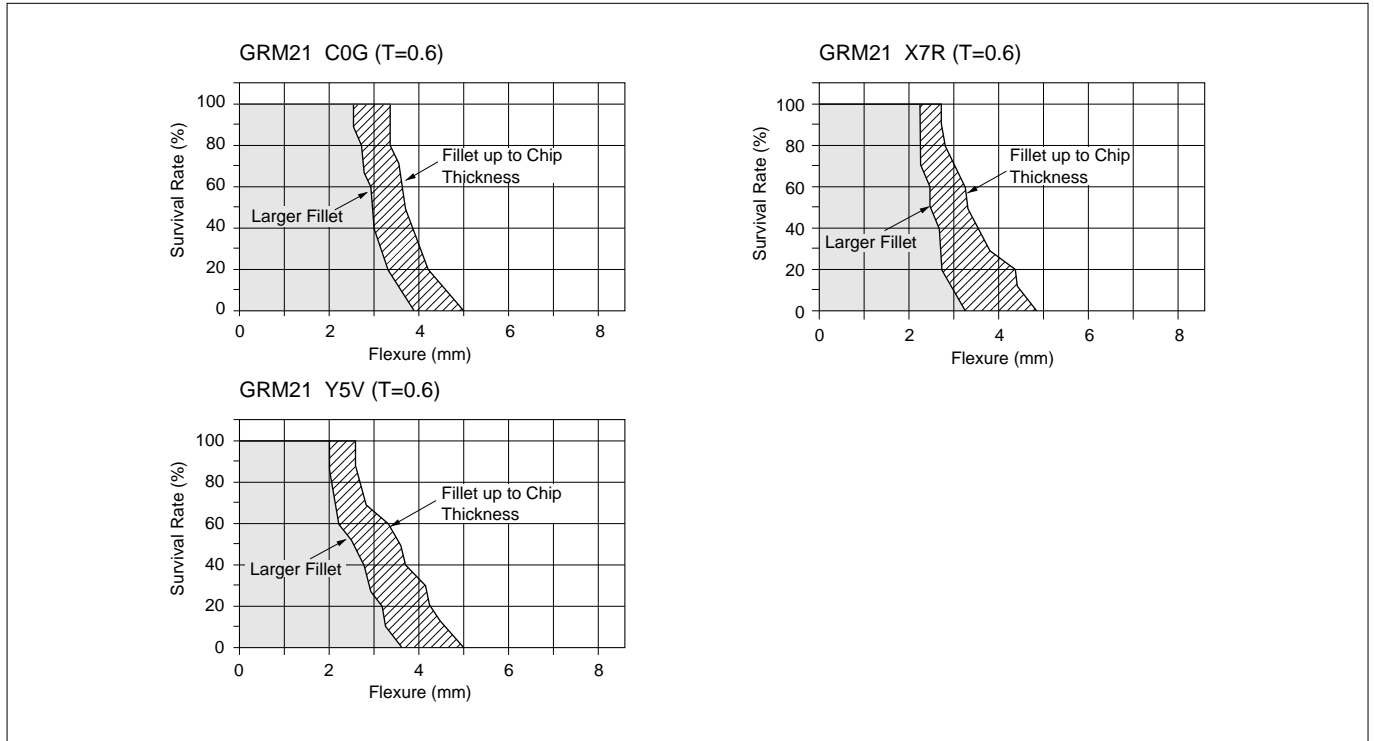

3. Temperature Cycling for Solder Fillet Height

(1) Test Method

Solder the chips to the substrate various test fixtures using sufficient amounts of solder to achieve the required fillet height. Then subject the fixtures to the cycle illustrated below 200 times.

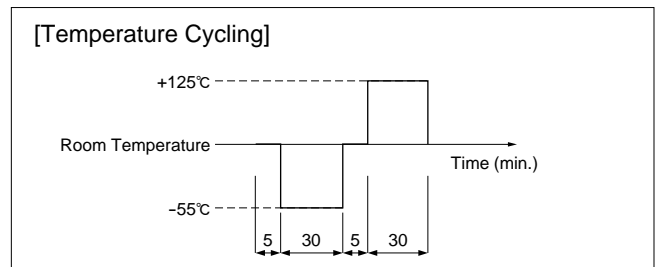

① Solder Amount

Alumina substrates are typically designed for reflow soldering.

Glass epoxy or paper phenol substrates are typically used for flow soldering.

② Material

- Alumina (Thickness : 0.64mm)
- Glass epoxy (Thickness : 1.6 mm)
- Paper phenol (Thickness : 1.6 mm)

[Solder Amount]		Alumina	Glass Epoxy or Paper Phenol
Solder Amount	①		
	②		
	③		
Solder to be used		6X4 Eutectic solder	

③ Land Dimension

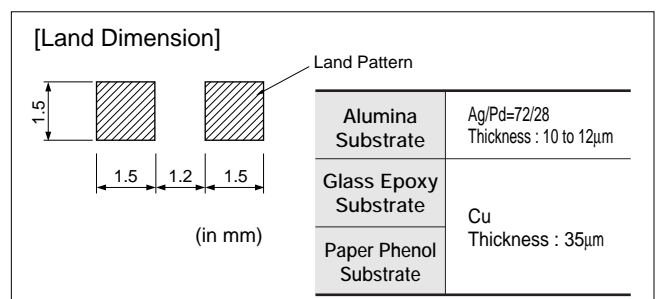

Continued on the following page.

Reference Data

Continued from the preceding page.

(2) Test Samples

GRM40 C0G/X7R/Y5V Characteristics T=0.6mm

(3) Acceptance Criteria

Products shall be determined to be defective if the change in capacitance has exceeded the values specified in Table 3.

Table 3

Characteristics	Change in Capacitance
C0G	Within $\pm 2.5\%$ or $\pm 0.25\text{pF}$, whichever is greater
X7R	Within $\pm 7.5\%$
Y5V	Within $\pm 20\%$

(4) Results

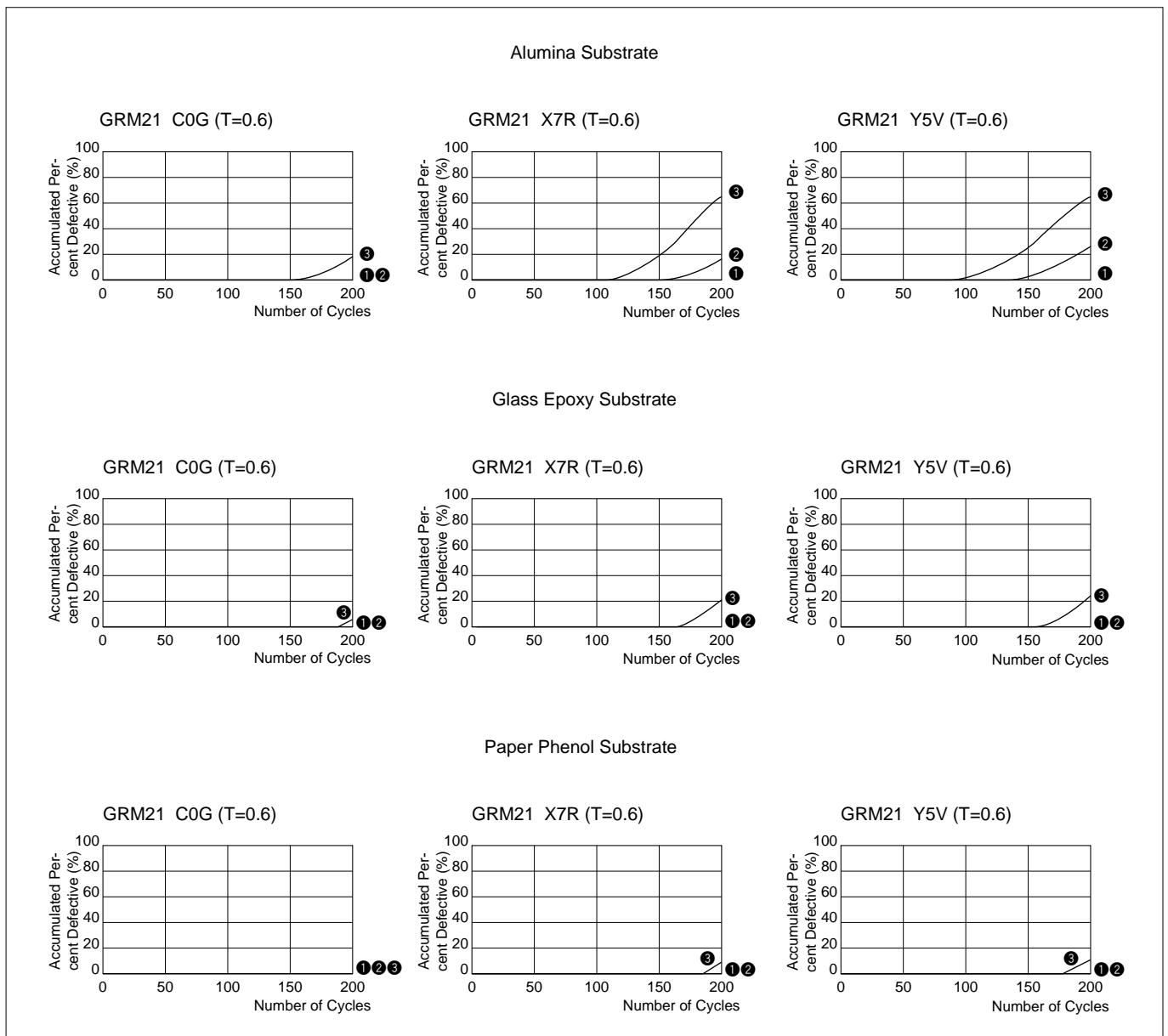

Continued on the following page.

Reference Data

Continued from the preceding page.

4. Board Bending Strength for Board Material

(1) Test Method

Solder the chip to the test board. Then bend the board using the method illustrated below, as measure capacitance.

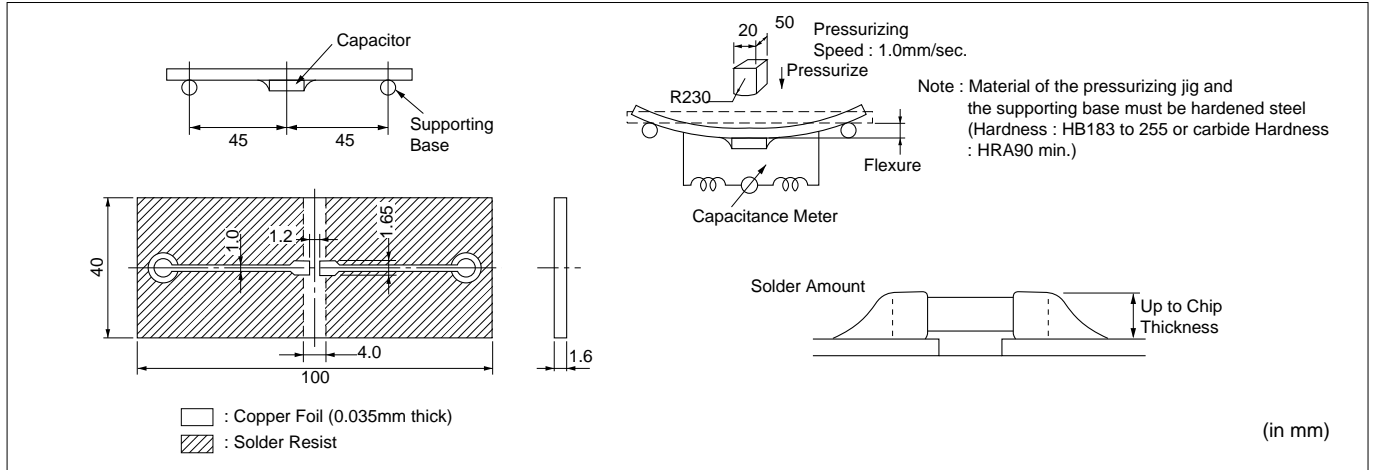

(2) Test Samples

GRM21 C0G/X7R/Y5V Characteristics T=0.6mm typical

(3) Acceptance Criteria

Products shall be determined to be defective if the change in capacitance has exceeded the values specified in Table 4.

Table 4

Characteristics	Change in Capacitance
C0G	Within $\pm 5\%$ or $\pm 0.5\text{pF}$, whichever is greater
X7R	Within $\pm 12.5\%$
Y5V	Within $\pm 20\%$

(4) Results

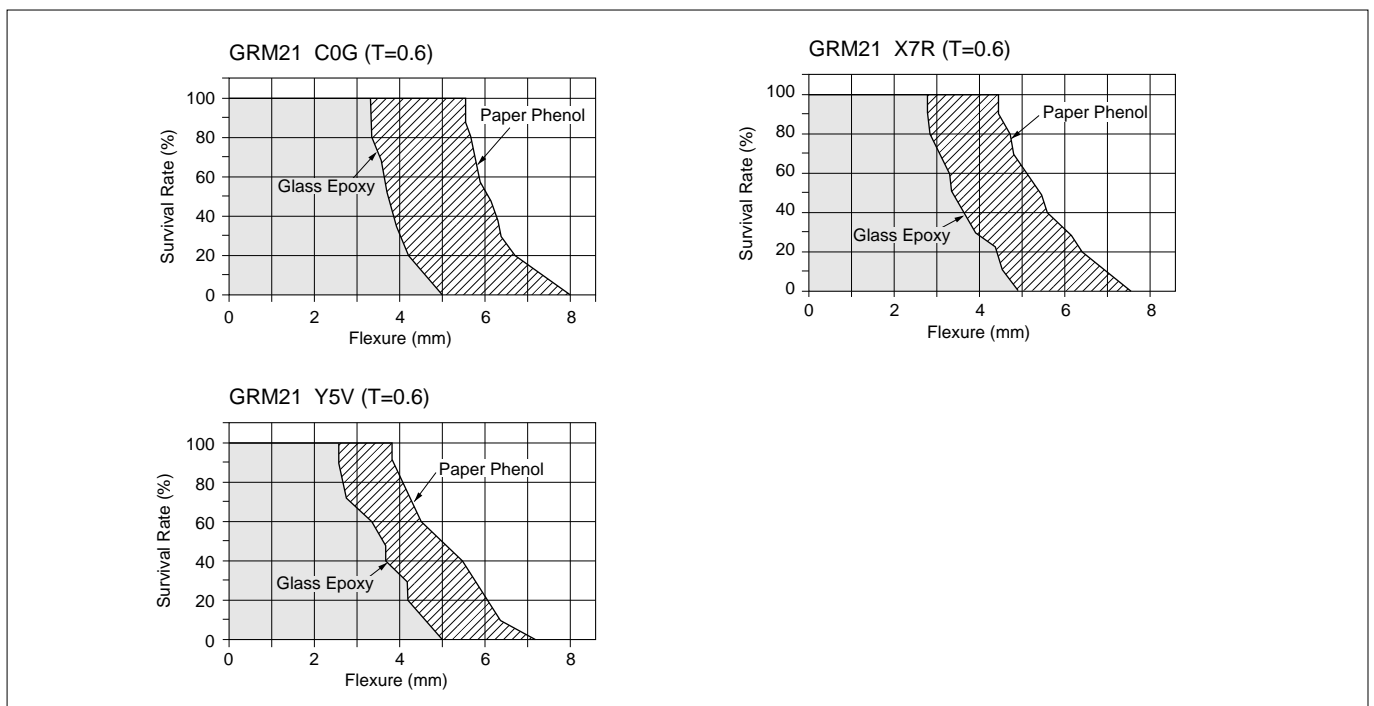

Continued on the following page.

Reference Data

Continued from the preceding page.

5. Break Strength

(1) Test Method

Place the chip on a steel plate as illustrated on the right. Increase load applied to a point near the center of the test sample.

(2) Test Samples

GRM21 C0G/X7R/Y5V Characteristics
GRM31 C0G/X7R/Y5V Characteristics

(3) Acceptance Criteria

Define the load that has caused the chip to break or crack, as the bending force.

(4) Explanation

Break strength, P, is proportionate to the square of the thickness of the ceramic element and is expressed as a curve of secondary degree.

The formula is :

$$P = \frac{2\gamma WT^2}{3L} \quad (\text{N})$$

- W : Width of ceramic element (mm)
- T : Thickness of element (mm)
- L : Distance between fulcrums (mm)
- γ : Bending stress (N/mm²)

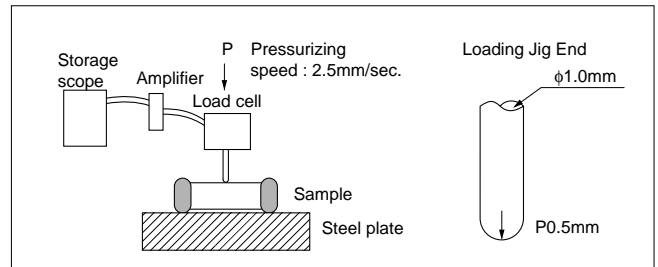

Chip Size	L	W	γ		
			C0G Characteristics	X7R Characteristics	Y5V Characteristics
GRM21	1.5	1.2	300	180	160
GRM31	2.7	1.5			

(in mm)

(5) Results

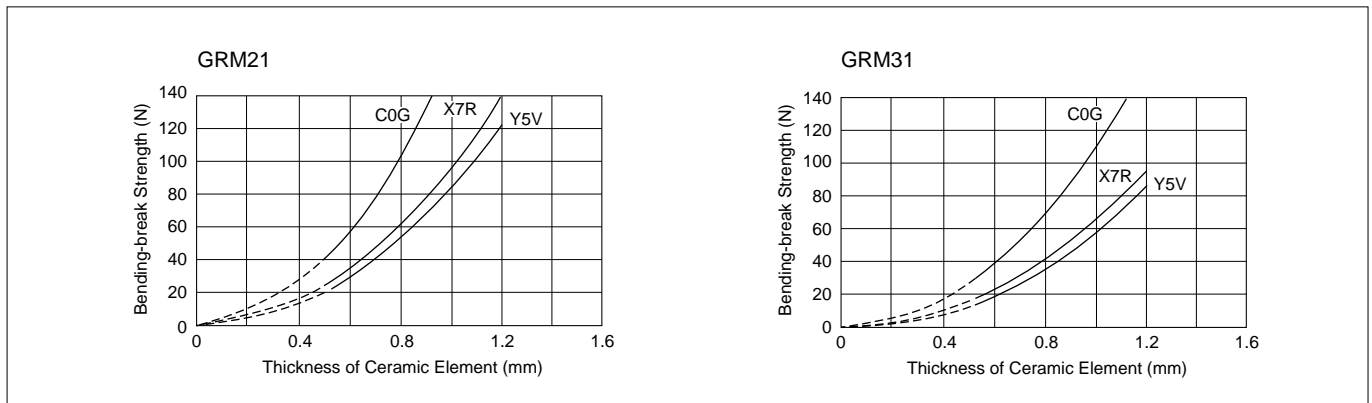

6. Thermal Shock

(1) Test method

After applying flux (an ethanol solution of 25% rosin), dip the chip in a solder bath (6X4 eutectic solder) in accordance with the following conditions :

(2) Test samples

GRM21 C0G/X7R/Y5V Characteristics T=0.6mm typical

(3) Acceptance criteria

Visually inspect the test sample with a 60-power optical microscope. Chips exhibiting breaks or cracks shall be determined to be defective.

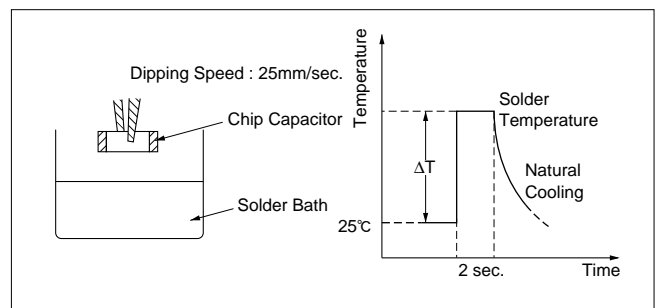

Continued on the following page.

Reference Data

Continued from the preceding page.

(4) Results

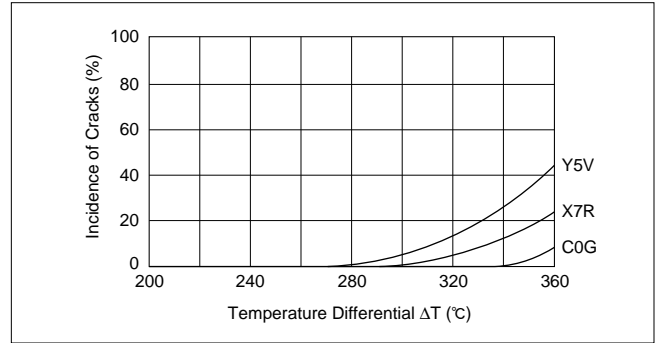

7. Solder Heat Resistance

(1) Test Method

① Reflow soldering :

Apply about 300 μm of solder paste over the alumina substrate. After reflow soldering, remove the chip and check for leaching that may have occurred on the outer electrode.

② Flow soldering :

After dipping the test sample with a pair of tweezers in wave solder (eutectic solder), check for leaching that may have occurred on the outer electrode.

③ Dip soldering :

After dipping the test sample with a pair of tweezers in static solder (eutectic solder), check for leaching that may have occurred on the outer electrode.

④ Flux to be used : An ethanol solution of 25 % rosin.

(2) Test samples

GRM21 : For flow/reflow soldering T=0.6mm

(3) Acceptance criteria

The starting time of leaching shall be defined as the time when the outer electrode has lost 25 % of the total edge length of A-B-C-D as illustrated :

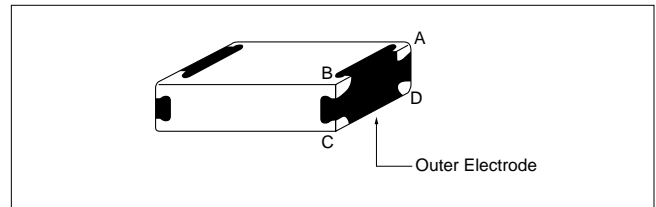

(4) Results

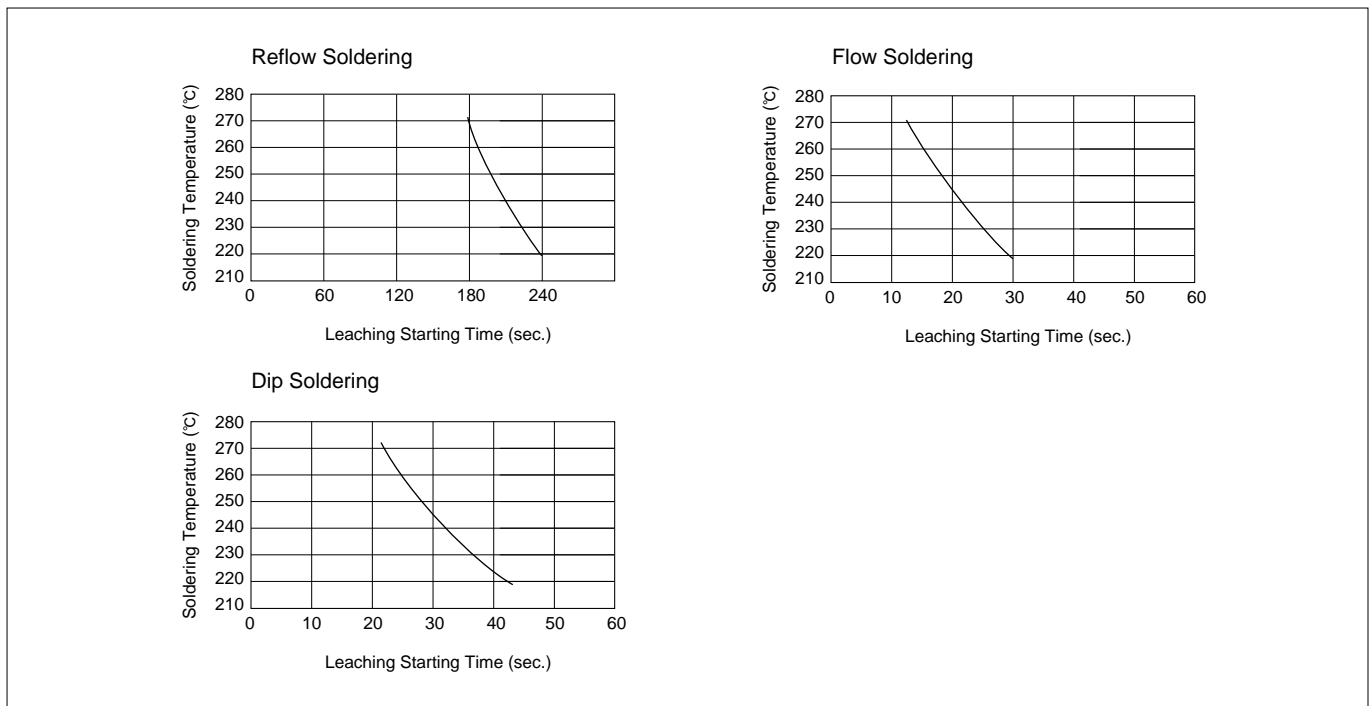

Continued on the following page.

Reference Data

Continued from the preceding page.

8. Thermal Shock when Making Corrections with a Soldering Iron

(1) Test Method

Apply a soldering iron meeting the conditions below to the soldered joint of a chip that has been soldered to a paper phenol board, while supplying wire solder. (Note: the soldering iron tip shall not directly touch the ceramic element of the chip.)

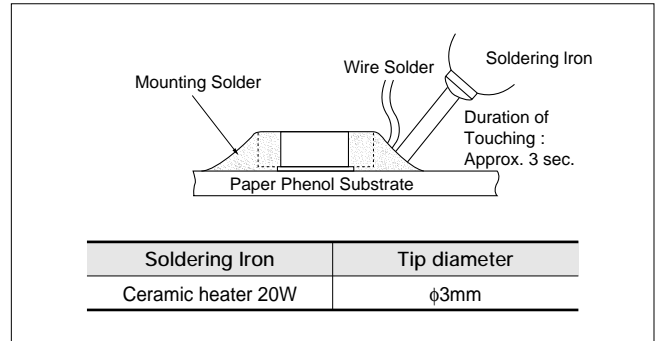

(2) Test Samples

GRM21 C0G/X7R/Y5V Characteristics T=0.6mm

(3) Acceptance Criteria for Defects

Observe the appearance of the test sample with a 60-power optical microscope. Those units displaying any breaks cracks shall be determined to be defective.

(4) Results

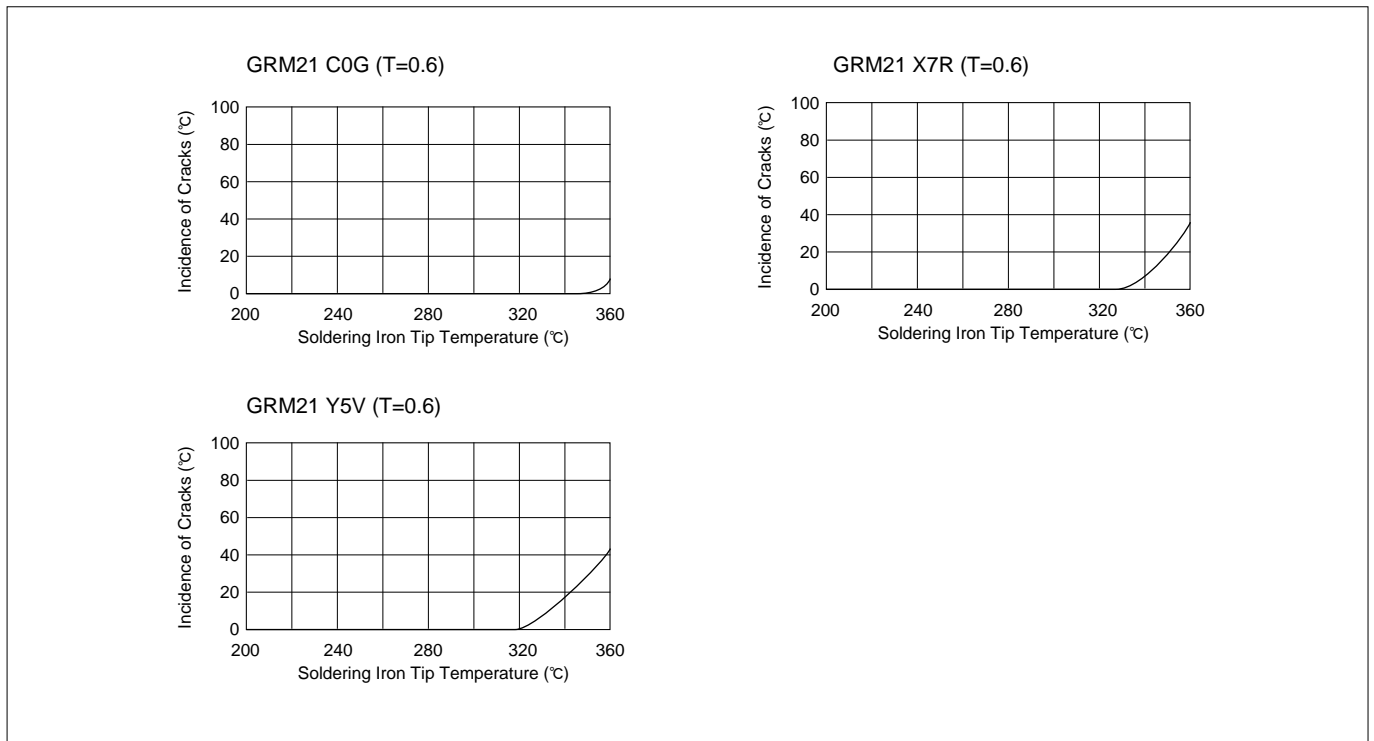

Chip Monolithic Ceramic Capacitors



Medium-voltage Low Dissipation Factor

■ Features

1. Murata's original internal electrode structure realizes high Flash-over Voltage.
2. A new monolithic structure for small, surface-mountable devices capable of operating at high-voltage levels.
3. Sn-plated external electrodes realize good solderability.
4. The GRM31 type for flow and reflow soldering, and other types for reflow soldering.
5. Low-loss and suitable for high-frequency circuits.
6. The temperature characteristics COG and SL are temperature compensating type, and R is high dielectric constant type.

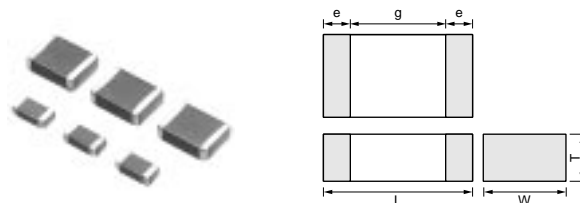

Part Number	Dimensions (mm)				
	L	W	T	e min.	g min.
GRM31A	3.2 ±0.2	1.6 ±0.2	1.0 ⁺⁰ _{-0.3}	0.3	1.5*
GRM31B			1.25 ⁺⁰ _{-0.3}		
GRM32Q	3.2 ±0.2	2.5 ±0.2	1.5 ⁺⁰ _{-0.3}		1.8
GRM42D	4.5 ±0.3	2.0 ±0.2	2.0 ±0.3		2.9
GRM43D	4.5 ±0.3	3.2 ±0.3	2.0 ⁺⁰ _{-0.3}		
GRM43E			2.5 ⁺⁰ _{-0.3}		

* GRM31B1X3D : 1.8mm min.

■ Application

- Ideal use on high-frequency pulse circuit such as snubber circuit for switching power supply, DC-DC converter, ballast(inverter fluorescent lamp), and so on. (COG and R Char.)
- Ideal for use as the ballast in liquid crystal back lighting inverters. (SL Char.)

Part Number	Rated Voltage (V)	TC Code	Capacitance (pF)	Length L (mm)	Width W (mm)	Thickness T (mm)	Electrode g (mm)	Electrode e (mm)
GRM31AR32J101KY01D	DC630	R	100 +10,-10%	3.2	1.6	1.0	1.5 min.	0.3 min.
GRM31A5C2J151JW01D	DC630	COG	150 +5,-5%	3.2	1.6	1.0	1.5 min.	0.3 min.
GRM31AR32J151KY01D	DC630	R	150 +10,-10%	3.2	1.6	1.0	1.5 min.	0.3 min.
GRM31AR32J221KY01D	DC630	R	220 +10,-10%	3.2	1.6	1.0	1.5 min.	0.3 min.
GRM31AR32J331KY01D	DC630	R	330 +10,-10%	3.2	1.6	1.0	1.5 min.	0.3 min.
GRM31A5C2J471JW01D	DC630	COG	470 +5,-5%	3.2	1.6	1.0	1.5 min.	0.3 min.
GRM31BR32J471KY01L	DC630	R	470 +10,-10%	3.2	1.6	1.25	1.5 min.	0.3 min.
GRM31BR32J681KY01L	DC630	R	680 +10,-10%	3.2	1.6	1.25	1.5 min.	0.3 min.
GRM31B5C2J102JW01L	DC630	COG	1000 +5,-5%	3.2	1.6	1.25	1.5 min.	0.3 min.
GRM31BR32J102KY01L	DC630	R	1000 +10,-10%	3.2	1.6	1.25	1.5 min.	0.3 min.
GRM31AR33A470KY01D	DC1000	R	47 +10,-10%	3.2	1.6	1.0	1.5 min.	0.3 min.
GRM31AR33A680KY01D	DC1000	R	68 +10,-10%	3.2	1.6	1.0	1.5 min.	0.3 min.
GRM31AR33A101KY01D	DC1000	R	100 +10,-10%	3.2	1.6	1.0	1.5 min.	0.3 min.
GRM31AR33A151KY01D	DC1000	R	150 +10,-10%	3.2	1.6	1.0	1.5 min.	0.3 min.
GRM31AR33A221KY01D	DC1000	R	220 +10,-10%	3.2	1.6	1.0	1.5 min.	0.3 min.
GRM31AR33A331KY01D	DC1000	R	330 +10,-10%	3.2	1.6	1.0	1.5 min.	0.3 min.
GRM31BR33A471KY01L	DC1000	R	470 +10,-10%	3.2	1.6	1.25	1.5 min.	0.3 min.
GRM31B1X3D100JY01L	DC2000	SL	10 +5,-5%	3.2	1.6	1.25	1.8 min.	0.3 min.
GRM31B1X3D120JY01L	DC2000	SL	12 +5,-5%	3.2	1.6	1.25	1.8 min.	0.3 min.
GRM31B1X3D150JY01L	DC2000	SL	15 +5,-5%	3.2	1.6	1.25	1.8 min.	0.3 min.
GRM31B1X3D180JY01L	DC2000	SL	18 +5,-5%	3.2	1.6	1.25	1.8 min.	0.3 min.
GRM31B1X3D220JY01L	DC2000	SL	22 +5,-5%	3.2	1.6	1.25	1.8 min.	0.3 min.
GRM32Q1X3D270JY01L	DC2000	SL	27 +5,-5%	3.2	2.5	1.5	1.8 min.	0.3 min.
GRM32Q1X3D330JY01L	DC2000	SL	33 +5,-5%	3.2	2.5	1.5	1.8 min.	0.3 min.
GRM32Q1X3D390JY01L	DC2000	SL	39 +5,-5%	3.2	2.5	1.5	1.8 min.	0.3 min.
GRM32Q1X3D470JY01L	DC2000	SL	47 +5,-5%	3.2	2.5	1.5	1.8 min.	0.3 min.
GRM32Q1X3D560JY01L	DC2000	SL	56 +5,-5%	3.2	2.5	1.5	1.8 min.	0.3 min.

Continued on the following page.

 Continued from the preceding page.

Part Number	Rated Voltage (V)	TC Code	Capacitance (pF)	Length L (mm)	Width W (mm)	Thickness T (mm)	Electrode g (mm)	Electrode e (mm)
GRM32Q1X3D680JY01L	DC2000	SL	68 +5,-5%	3.2	2.5	1.5	1.8 min.	0.3 min.
GRM32Q1X3D820JY01L	DC2000	SL	82 +5,-5%	3.2	2.5	1.5	1.8 min.	0.3 min.
GRM43D1X3D121JY01L	DC2000	SL	120 +5,-5%	4.5	3.2	2.0	2.9 min.	0.3 min.
GRM43D1X3D151JY01L	DC2000	SL	150 +5,-5%	4.5	3.2	2.0	2.9 min.	0.3 min.
GRM43D1X3D181JY01L	DC2000	SL	180 +5,-5%	4.5	3.2	2.0	2.9 min.	0.3 min.
GRM43D1X3D221JY01L	DC2000	SL	220 +5,-5%	4.5	3.2	2.0	2.9 min.	0.3 min.
GRM42D1X3F100JY02L	DC3150	SL	10 +5,-5%	4.5	2.0	2.0	2.9 min.	0.3 min.
GRM42D1X3F120JY02L	DC3150	SL	12 +5,-5%	4.5	2.0	2.0	2.9 min.	0.3 min.
GRM42D1X3F150JY02L	DC3150	SL	15 +5,-5%	4.5	2.0	2.0	2.9 min.	0.3 min.
GRM42D1X3F180JY02L	DC3150	SL	18 +5,-5%	4.5	2.0	2.0	2.9 min.	0.3 min.
GRM42D1X3F220JY02L	DC3150	SL	22 +5,-5%	4.5	2.0	2.0	2.9 min.	0.3 min.
GRM42D1X3F270JY02L	DC3150	SL	27 +5,-5%	4.5	2.0	2.0	2.9 min.	0.3 min.
GRM42D1X3F330JY02L	DC3150	SL	33 +5,-5%	4.5	2.0	2.0	2.9 min.	0.3 min.
GRM42D1X3F390JY02L	DC3150	SL	39 +5,-5%	4.5	2.0	2.0	2.9 min.	0.3 min.
GRM42D1X3F470JY02L	DC3150	SL	47 +5,-5%	4.5	2.0	2.0	2.9 min.	0.3 min.
GRM42D1X3F560JY02L	DC3150	SL	56 +5,-5%	4.5	2.0	2.0	2.9 min.	0.3 min.
GRM42D1X3F680JY02L	DC3150	SL	68 +5,-5%	4.5	2.0	2.0	2.9 min.	0.3 min.
GRM42D1X3F820JY02L	DC3150	SL	82 +5,-5%	4.5	2.0	2.0	2.9 min.	0.3 min.
GRM43E1X3F101JY01L	DC3150	SL	100 +5,-5%	4.5	3.2	2.5	2.9 min.	0.3 min.

Specifications and Test Methods

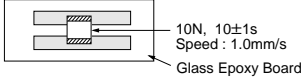
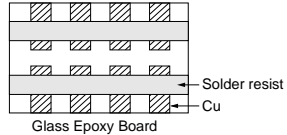
No.	Item	Specification		Test Method												
		Temperature Compensating Type (C0G, SL Char.)	High Dielectric Constant Type (R Char.)													
1	Operating Temperature Range	-55 to +125°C														
2	Appearance	No defects or abnormalities.		Visual inspection.												
3	Dimensions	Within the specified dimension.		Using calipers.												
4	Dielectric Strength	No defects or abnormalities.		No failure shall be observed when voltage in Table is applied between the terminations for 1 to 5 s, provided the charge/discharge current is less than 50mA. <table border="1" style="margin-left: auto; margin-right: auto; border-collapse: collapse;"> <thead> <tr> <th>Rated voltage</th> <th>Test voltage</th> </tr> </thead> <tbody> <tr> <td>More than DC 1kV</td> <td>120% of the rated voltage</td> </tr> <tr> <td>Less than DC 1kV</td> <td>150% of the rated voltage</td> </tr> </tbody> </table>	Rated voltage	Test voltage	More than DC 1kV	120% of the rated voltage	Less than DC 1kV	150% of the rated voltage						
Rated voltage	Test voltage															
More than DC 1kV	120% of the rated voltage															
Less than DC 1kV	150% of the rated voltage															
5	Insulation Resistance (I.R.)	More than 10,000MΩ		The insulation resistance shall be measured with 500±50V and within 60±5 s of charging.												
6	Capacitance	Within the specified tolerance.		The capacitance/Q/D.F. shall be measured at 20°C at the frequency and voltage shown as follows.												
7	Q/ Dissipation Factor (D.F.)	C≥30pF : Q≥1,000 C<30pF : Q≥400+20C C : Nominal Capacitance (pF)	D.F.≤0.01	(1) Temperature Compensating Type Frequency : 1±0.2MHz Voltage : 0.5 to 5V (r.m.s.) (2) High Dielectric Constant Type Frequency : 1±0.2kHz Voltage : 1±0.2V (r.m.s.)												
8	Capacitance Temperature Characteristics	Temp. Coefficient C0G char. : 0±30ppm/°C (Temp. Range : +20 to +85°C) SL char. : +350 to -1,000 ppm/°C (Temp. Range : +20 to +85°C)	Cap. Change Within ±15%	(1) Temperature Compensating Type The temperature coefficient is determined using the capacitance measured in step 3 as a reference. When cycling the temperature sequentially from step 1 through 5 (+20 to +85 °C) the capacitance shall be within the specified tolerance for the temperature coefficient. <table border="1" style="margin-left: auto; margin-right: auto; border-collapse: collapse;"> <thead> <tr> <th>Step</th> <th>Temperature(°C)</th> </tr> </thead> <tbody> <tr> <td>1</td> <td>20±2 (25±2 for C0G char.)</td> </tr> <tr> <td>2</td> <td>Min. Operating Temp.±3</td> </tr> <tr> <td>3</td> <td>20±2 (25±2 for C0G char.)</td> </tr> <tr> <td>4</td> <td>Max. Operating Temp.±2</td> </tr> <tr> <td>5</td> <td>20±2 (25±2 for C0G char.)</td> </tr> </tbody> </table> (2) High Dielectric Constant Type The range of capacitance change compared to the 20°C value within -55 to +125°C shall be within the specified range. •Pretreatment Perform a heat treatment at 150 ±0 °C for 60±5 min and then let sit for 24±2 h at room condition.	Step	Temperature(°C)	1	20±2 (25±2 for C0G char.)	2	Min. Operating Temp.±3	3	20±2 (25±2 for C0G char.)	4	Max. Operating Temp.±2	5	20±2 (25±2 for C0G char.)
Step	Temperature(°C)															
1	20±2 (25±2 for C0G char.)															
2	Min. Operating Temp.±3															
3	20±2 (25±2 for C0G char.)															
4	Max. Operating Temp.±2															
5	20±2 (25±2 for C0G char.)															
9	Adhesive Strength of Termination	No removal of the terminations or other defect shall occur.		Solder the capacitor to the testing jig (glass epoxy board) shown in Fig.1 using a eutectic solder. Then apply 10N force in the direction of the arrow. The soldering shall be done either with an iron or using the reflow method and shall be conducted with care so that the soldering is uniform and free of defects such as heat shock. <div style="text-align: center;">  <p>10N, 10±1s Speed : 1.0mm/s Glass Epoxy Board</p> </div> <p>Fig.1</p>												
10	Vibration Resistance	Appearance	No defects or abnormalities.		Solder the capacitor to the test jig (glass epoxy board). The capacitor shall be subjected to a simple harmonic motion having a total amplitude of 1.5mm, the frequency being varied uniformly between the approximate limits of 10 and 55Hz. The frequency range, from 10 to 55Hz and return to 10Hz, shall be traversed in approximately 1 min. This motion shall be applied for a period of 2 h in each 3 mutually perpendicular directions (total of 6 h). <div style="text-align: center;">  <p>Solder resist Cu Glass Epoxy Board</p> </div>											
		Capacitance	Within the specified tolerance.													
	Q/D.F.	C≥30pF : Q≥1,000 C<30pF : Q≥400+20C C : Nominal Capacitance (pF)	D.F.≤0.01													

"Room condition" Temperature : 15 to 35°C, Relative humidity : 45 to 75%, Atmosphere pressure : 86 to 106kPa

Continued on the following page.

Specifications and Test Methods

Continued from the preceding page.

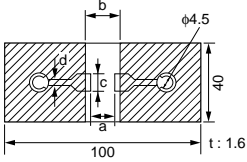
No.	Item	Specification		Test Method																								
		Temperature Compensating Type (C0G, SL Char.)	High Dielectric Constant Type (R Char.)																									
11	Deflection	No cracking or marking defects shall occur.		Solder the capacitor to the testing jig (glass epoxy board) shown in Fig.2 using a eutectic solder. Then apply a force in the direction shown in Fig.3. The soldering shall be done either with an iron or using the reflow method and shall be conducted with care so that the soldering is uniform and free of defects such as heat shock.																								
		 <table border="1" style="margin: 10px auto; border-collapse: collapse;"> <thead> <tr> <th rowspan="2">L×W (mm)</th> <th colspan="4">Dimension (mm)</th> </tr> <tr> <th>a</th> <th>b</th> <th>c</th> <th>d</th> </tr> </thead> <tbody> <tr> <td>3.2×1.6</td> <td>2.2</td> <td>5.0</td> <td>2.0</td> <td rowspan="4" style="text-align: center; vertical-align: middle;">1.0</td> </tr> <tr> <td>3.2×2.5</td> <td>2.2</td> <td>5.0</td> <td>2.9</td> </tr> <tr> <td>4.5×2.0</td> <td>3.5</td> <td>7.0</td> <td>2.4</td> </tr> <tr> <td>4.5×3.2</td> <td>3.5</td> <td>7.0</td> <td>3.7</td> </tr> </tbody> </table> <p style="text-align: center;">Fig.2</p>			L×W (mm)	Dimension (mm)				a	b	c	d	3.2×1.6	2.2	5.0	2.0	1.0	3.2×2.5	2.2	5.0	2.9	4.5×2.0	3.5	7.0	2.4	4.5×3.2	3.5
L×W (mm)	Dimension (mm)																											
	a	b	c	d																								
3.2×1.6	2.2	5.0	2.0	1.0																								
3.2×2.5	2.2	5.0	2.9																									
4.5×2.0	3.5	7.0	2.4																									
4.5×3.2	3.5	7.0	3.7																									
12	Solderability of Termination	75% of the terminations are to be soldered evenly and continuously.		Immerse the capacitor in a solution of ethanol (JIS-K-8101) and rosin (JIS-K-5902) (25% rosin in weight proportion). Immerse in eutectic solder solution for 2±0.5 s at 235±5°C. Immersing speed : 25±2.5mm/s																								
13	Resistance to Soldering Heat	Appearance	No marking defects.		Preheat the capacitor at 120 to 150°C* for 1 min. Immerse the capacitor in eutectic solder solution at 260±5°C for 10±1 s. Let sit at room condition for 24±2 h, then measure. •Immersing speed : 25±2.5mm/s •Pretreatment for high dielectric constant type Perform a heat treatment at 150±0°C for 60±5 min and then let sit for 24±2 h at room condition. *Preheating for more than 3.2×2.5mm																							
		Capacitance Change	Within ±2.5% or ±0.25pF (Whichever is larger)	Within ±10%																								
		Q/D.F.	C≥30pF : Q≥1,000 C<30pF : Q≥400+20C C : Nominal Capacitance (pF)	D.F.≤0.01																								
		I.R.	More than 10,000MΩ																									
		Dielectric Strength	Pass the item No.4.																									
14	Temperature Cycle	Appearance	No marking defects.		Fix the capacitor to the supporting jig (glass epoxy board) shown in Fig.4 using a eutectic solder. Perform the five cycles according to the four heat treatments listed in the following table. Let sit for 24±2 h at room condition, then measure.																							
		Capacitance Change	Within ±2.5% or ±0.25pF (Whichever is larger)	Within ±10%																								
		Q/D.F.	C≥30pF : Q≥1,000 C<30pF : Q≥400+20C C : Nominal Capacitance (pF)	D.F.≤0.01																								
		I.R.	More than 10,000MΩ																									
		Dielectric Strength	Pass the item No.4.																									
15	Humidity (Steady State)	Appearance	No marking defects.		Sit the capacitor at 40±2°C and relative humidity 90 to 95% for 500±20h. Remove and let sit for 24±2 h at room condition, then measure. •Pretreatment for high dielectric constant type Perform a heat treatment at 150±0°C for 60±5 min and then let sit for 24±2 h at room condition.																							
		Capacitance Change	Within ±5.0% or ±0.5pF (Whichever is larger)	Within ±10%																								
		Q/D.F.	C≥30pF : Q≥350 C<30pF : Q≥275+ $\frac{C}{5}$ C : Nominal Capacitance (pF)	D.F.≤0.01																								
		I.R.	More than 1,000MΩ																									
		Dielectric Strength	Pass the item No.4.																									

"Room condition" Temperature : 15 to 35°C, Relative humidity : 45 to 75%, Atmosphere pressure : 86 to 106kPa

Continued on the following page.

Specifications and Test Methods

Continued from the preceding page.

No.	Item	Specification		Test Method						
		Temperature Compensating Type (C0G, SL Char.)	High Dielectric Constant Type (R Char.)							
16	Life	Appearance	No marking defects.		Apply the voltage in following table for $1,000 \pm^{+48}$ at maximum operating temperature $\pm 3^{\circ}\text{C}$. Remove and let sit for 24 ± 2 h at room condition, then measure. The charge/discharge current is less than 50mA. •Pretreatment for high dielectric constant type Apply test voltage for 60 ± 5 min at test temperature. Remove and let sit for 24 ± 2 h at room condition.					
		Capacitance Change	Within $\pm 3.0\%$ or $\pm 0.3\text{pF}$ (Whichever is larger)	Within $\pm 10\%$						
		Q/D.F.	$C \geq 30\text{pF} : Q \geq 350$ $C < 30\text{pF} : Q \geq 275 + \frac{C}{10}$ C : Nominal Capacitance (pF)	D.F. ≤ 0.02						
		I.R.	More than $1,000\text{M}\Omega$							
		Dielectric Strength	Pass the item No.4.							
				<table border="1" style="width: 100%; border-collapse: collapse;"> <thead> <tr> <th style="width: 50%;">Rated voltage</th> <th style="width: 50%;">Test voltage</th> </tr> </thead> <tbody> <tr> <td>More than DC 1kV</td> <td>Rated voltage</td> </tr> <tr> <td>Less than DC 1kV</td> <td>120% of the rated voltage</td> </tr> </tbody> </table>	Rated voltage	Test voltage	More than DC 1kV	Rated voltage	Less than DC 1kV	120% of the rated voltage
Rated voltage	Test voltage									
More than DC 1kV	Rated voltage									
Less than DC 1kV	120% of the rated voltage									

"Room condition" Temperature : 15 to 35°C, Relative humidity : 45 to 75%, Atmosphere pressure : 86 to 106kPa

Chip Monolithic Ceramic Capacitors



Medium-voltage High-Capacitance for General-Use

■ Features

1. A new monolithic structure for small, high-capacitance capable of operating at high-voltage levels.
2. Sn-plated external electrodes allow mounting without silver compound solder.
3. The GRM21/31 type for flow and reflow soldering, and other types for reflow soldering.

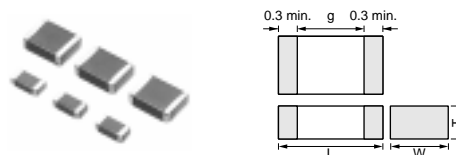

■ Applications

1. Ideal use as hot-cold coupling for DC-DC converter.
2. Ideal use on line filter and ringer detector for telephone, facsimile and modem.
3. Ideal use on diode-snubber circuit for switching power supply.

Part Number	Dimensions (mm)			
	L	W	T	g min.
GRM21A	2.0 ±0.2	1.25 ±0.2	1.0 +0,-0.3	0.7
GRM21B			1.25 ±0.2	
GRM31B	3.2 ±0.2	1.6 ±0.2	1.25 +0,-0.3	1.2
GRM31C			1.6 ±0.2	
GRM32Q	3.2 ±0.3	2.5 ±0.2	1.5 +0,-0.3	2.2
GRM32D			2.0 +0,-0.3	
GRM43Q	4.5 ±0.4	3.2 ±0.3	1.5 +0,-0.3	3.2
GRM43D			2.0 +0,-0.3	
GRM55D	5.7 ±0.4	5.0 ±0.4	2.0 +0,-0.3	3.2
GRM55X			2.7 +0,-0.3	

Part Number	Rated Voltage (V)	TC Code	Capacitance	Length L (mm)	Width W (mm)	Thickness T (mm)	Electrode g (mm)	Electrode e (mm)
GRM21AR72E102KW01D	DC250	X7R	1000pF +10,-10%	2.0	1.25	1.0	0.7 min.	0.3 min.
GRM21AR72E152KW01D	DC250	X7R	1500pF +10,-10%	2.0	1.25	1.0	0.7 min.	0.3 min.
GRM21AR72E222KW01D	DC250	X7R	2200pF +10,-10%	2.0	1.25	1.0	0.7 min.	0.3 min.
GRM21AR72E332KW01D	DC250	X7R	3300pF +10,-10%	2.0	1.25	1.0	0.7 min.	0.3 min.
GRM21AR72E472KW01D	DC250	X7R	4700pF +10,-10%	2.0	1.25	1.0	0.7 min.	0.3 min.
GRM21AR72E682KW01D	DC250	X7R	6800pF +10,-10%	2.0	1.25	1.0	0.7 min.	0.3 min.
GRM21BR72E103KW03L	DC250	X7R	10000pF +10,-10%	2.0	1.25	1.25	0.7 min.	0.3 min.
GRM31BR72E153KW01L	DC250	X7R	15000pF +10,-10%	3.2	1.6	1.25	1.2 min.	0.3 min.
GRM31BR72E223KW01L	DC250	X7R	22000pF +10,-10%	3.2	1.6	1.25	1.2 min.	0.3 min.
GRM31CR72E333KW03L	DC250	X7R	33000pF +10,-10%	3.2	1.6	1.6	1.2 min.	0.3 min.
GRM31CR72E473KW03L	DC250	X7R	47000pF +10,-10%	3.2	1.6	1.6	1.2 min.	0.3 min.
GRM32QR72E683KW01L	DC250	X7R	68000pF +10,-10%	3.2	2.5	1.5	1.2 min.	0.3 min.
GRM32DR72E104KW01L	DC250	X7R	0.1µF +10,-10%	3.2	2.5	2.0	1.2 min.	0.3 min.
GRM43QR72E154KW01L	DC250	X7R	0.15µF +10,-10%	4.5	3.2	1.5	2.2 min.	0.3 min.
GRM43DR72E224KW01L	DC250	X7R	0.22µF +10,-10%	4.5	3.2	2.0	2.2 min.	0.3 min.
GRM55DR72E334KW01L	DC250	X7R	0.33µF +10,-10%	5.7	5.0	2.0	3.2 min.	0.3 min.
GRM55DR72E474KW01L	DC250	X7R	0.47µF +10,-10%	5.7	5.0	2.0	3.2 min.	0.3 min.
GRM31BR72J102KW01L	DC630	X7R	1000pF +10,-10%	3.2	1.6	1.25	1.2 min.	0.3 min.
GRM31BR72J152KW01L	DC630	X7R	1500pF +10,-10%	3.2	1.6	1.25	1.2 min.	0.3 min.
GRM31BR72J222KW01L	DC630	X7R	2200pF +10,-10%	3.2	1.6	1.25	1.2 min.	0.3 min.
GRM31BR72J332KW01L	DC630	X7R	3300pF +10,-10%	3.2	1.6	1.25	1.2 min.	0.3 min.
GRM31BR72J472KW01L	DC630	X7R	4700pF +10,-10%	3.2	1.6	1.25	1.2 min.	0.3 min.
GRM31BR72J682KW01L	DC630	X7R	6800pF +10,-10%	3.2	1.6	1.25	1.2 min.	0.3 min.
GRM31BR72J103KW01L	DC630	X7R	10000pF +10,-10%	3.2	1.6	1.25	1.2 min.	0.3 min.
GRM31CR72J153KW03L	DC630	X7R	15000pF +10,-10%	3.2	1.6	1.6	1.2 min.	0.3 min.
GRM32QR72J223KW01L	DC630	X7R	22000pF +10,-10%	3.2	2.5	1.5	1.2 min.	0.3 min.
GRM32DR72J333KW01L	DC630	X7R	33000pF +10,-10%	3.2	2.5	2.0	1.2 min.	0.3 min.
GRM32DR72J473KW01L	DC630	X7R	47000pF +10,-10%	3.2	2.5	2.0	1.2 min.	0.3 min.
GRM43QR72J683KW01L	DC630	X7R	68000pF +10,-10%	4.5	3.2	1.5	2.2 min.	0.3 min.
GRM43DR72J104KW01L	DC630	X7R	0.1µF +10,-10%	4.5	3.2	2.0	2.2 min.	0.3 min.
GRM55DB32J154KY01L	DC630	B	0.15µF +10,-10%	5.7	5.0	2.0	3.5 min.	0.3 min.
GRM55XB32J224KY05L	DC630	B	0.22µF +10,-10%	5.7	5.0	2.7	3.5 min.	0.3 min.

Specifications and Test Methods

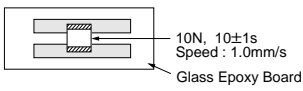
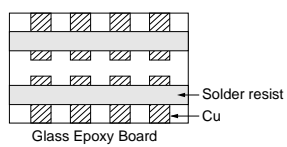
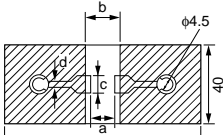
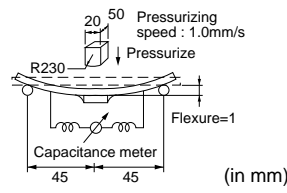
No.	Item	Specification	Test Method																																			
1	Operating Temperature Range	-55 to +125°C	-																																			
2	Appearance	No defects or abnormalities.	Visual inspection.																																			
3	Dimensions	Within the specified dimensions.	Using calipers.																																			
4	Dielectric Strength	No defects or abnormalities.	No failure shall be observed when 150% of the rated voltage (200% of the rated voltage in case of rated voltage: DC 250V) is applied between the terminations for 1 to 5 s, provided the charge/discharge current is less than 50mA.																																			
5	Insulation Resistance (I.R.)	C ≥ 0.01μF : More than 100MΩ • μF C < 0.01μF : More than 10,000MΩ	The insulation resistance shall be measured with 500±50V (250±50V in case of rated voltage: DC 250V) and within 60±5 s of charging.																																			
6	Capacitance	Within the specified tolerance.	The capacitance/D.F. shall be measured at 20°C at a frequency of 1±0.2kHz and a voltage of 1±0.2V (r.m.s.)																																			
7	Dissipation Factor (D.F.)	0.025 max.	<ul style="list-style-type: none"> •Pretreatment Perform a heat treatment at 150 ± 0.5 °C for 60±5 min and then let sit for 24±2 h at room condition. 																																			
8	Capacitance Temperature Characteristics	Cap. Change Within ±10% (B) (Temp. Range : -25 to +85°C) Within ±15% (X7R) (Temp. Range : -55 to +125°C)	The range of capacitance change compared with the 20°C (B), 25°C (X7R) value within -25 to +85°C shall be within the specified range. <ul style="list-style-type: none"> •Pretreatment Perform a heat treatment at 150 ± 0.5 °C for 60±5 min and then let sit for 24±2 h at room condition. 																																			
9	Adhesive Strength of Termination	No removal of the terminations or other defect shall occur.	Solder the capacitor to the testing jig (glass epoxy board) shown in Fig.1 using a eutectic solder. Then apply 10N force in the direction of the arrow. The soldering shall be done either with an iron or using the reflow method and shall be conducted with care so that the soldering is uniform and free of defects such as heat shock. <div style="text-align: center;">  <p>10N, 10±1s Speed : 1.0mm/s Glass Epoxy Board</p> </div> <p style="text-align: center;">Fig.1</p>																																			
10	Appearance	No defects or abnormalities.	Solder the capacitor to the test jig (glass epoxy board). The capacitor shall be subjected to a simple harmonic motion having a total amplitude of 1.5mm, the frequency being varied uniformly between the approximate limits of 10 and 55Hz. The frequency range, from 10 to 55Hz and return to 10Hz, shall be traversed in approximately 1 min. This motion shall be applied for a period of 2 h in each 3 mutually perpendicular directions (total of 6 h). <div style="text-align: center;">  <p>Solder resist Cu Glass Epoxy Board</p> </div>																																			
	Capacitance	Within the specified tolerance.																																				
	D.F.	0.025 max.																																				
11	Deflection	No cracking or marking defects shall occur. <div style="text-align: center;">  <table border="1" style="margin: 10px auto;"> <thead> <tr> <th rowspan="2">L×W (mm)</th> <th colspan="4">Dimension (mm)</th> <th rowspan="2">1.0</th> </tr> <tr> <th>a</th> <th>b</th> <th>c</th> <th>d</th> </tr> </thead> <tbody> <tr> <td>2.0×1.25</td> <td>1.2</td> <td>4.0</td> <td>1.65</td> <td></td> </tr> <tr> <td>3.2×1.6</td> <td>2.2</td> <td>5.0</td> <td>2.0</td> <td></td> </tr> <tr> <td>3.2×2.5</td> <td>2.2</td> <td>5.0</td> <td>2.9</td> <td></td> </tr> <tr> <td>4.5×3.2</td> <td>3.5</td> <td>7.0</td> <td>3.7</td> <td></td> </tr> <tr> <td>5.7×5.0</td> <td>4.5</td> <td>8.0</td> <td>5.6</td> <td></td> </tr> </tbody> </table> <p style="text-align: center;">Fig.2</p> </div>	L×W (mm)	Dimension (mm)				1.0	a	b	c	d	2.0×1.25	1.2	4.0	1.65		3.2×1.6	2.2	5.0	2.0		3.2×2.5	2.2	5.0	2.9		4.5×3.2	3.5	7.0	3.7		5.7×5.0	4.5	8.0	5.6		Solder the capacitor to the testing jig (glass epoxy board) shown in Fig.2 using a eutectic solder. Then apply a force in the direction shown in Fig.3. The soldering shall be done either with an iron or using the reflow method and shall be conducted with care so that the soldering is uniform and free of defects such as heat shock. <div style="text-align: center;">  <p>20 50 Pressurizing speed : 1.0mm/s Pressurize R230 Capacitance meter Flexure=1 45 45 (in mm)</p> </div> <p style="text-align: center;">Fig.3</p>
L×W (mm)	Dimension (mm)				1.0																																	
	a	b	c	d																																		
2.0×1.25	1.2	4.0	1.65																																			
3.2×1.6	2.2	5.0	2.0																																			
3.2×2.5	2.2	5.0	2.9																																			
4.5×3.2	3.5	7.0	3.7																																			
5.7×5.0	4.5	8.0	5.6																																			

"Room condition" Temperature : 15 to 35°C, Relative humidity : 45 to 75%, Atmosphere pressure : 86 to 106kPa

Continued on the following page.

Specifications and Test Methods

Continued from the preceding page.

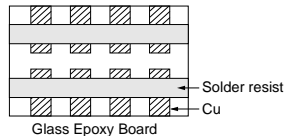
No.	Item	Specification	Test Method															
12	Solderability of Termination	75% of the terminations is to be soldered evenly and continuously.	Immerse the capacitor in a solution of ethanol (JIS-K-8101) and rosin (JIS-K-5902) (25% rosin in weight proportion). Immerse in eutectic solder solution for 2±0.5 s at 235±5°C. Immersing speed : 25±2.5mm/s															
13	Resistance to Soldering Heat	Appearance	No marking defects.															
		Capacitance Change	Within ±10%															
		D.F.	0.025 max.															
		I.R.	C≥0.01μF : More than 100MΩ • μF C<0.01μF : More than 10,000MΩ															
		Dielectric Strength	Pass the item No.4.															
			Preheat the capacitor at 120 to 150°C* for 1 min. Immerse the capacitor in eutectic solder solution at 260±5°C for 10±1 s. Let sit at room condition for 24±2 h, then measure. •Immersing speed : 25±2.5mm/s •Pretreatment Perform a heat treatment at 150 ± ₁ 8°C for 60±5 min and then let sit for 24±2 h at room condition. *Preheating for more than 3.2X2.5mm <table border="1" style="margin-left: auto; margin-right: auto; border-collapse: collapse;"> <thead> <tr> <th>Step</th> <th>Temperature</th> <th>Time</th> </tr> </thead> <tbody> <tr> <td>1</td> <td>100°C to 120°C</td> <td>1 min.</td> </tr> <tr> <td>2</td> <td>170°C to 200°C</td> <td>1 min.</td> </tr> </tbody> </table>	Step	Temperature	Time	1	100°C to 120°C	1 min.	2	170°C to 200°C	1 min.						
Step	Temperature	Time																
1	100°C to 120°C	1 min.																
2	170°C to 200°C	1 min.																
14	Temperature Cycle	Appearance	No marking defects.															
		Capacitance Change	Within ±7.5%															
		D.F.	0.025 max.															
		I.R.	C≥0.01μF : More than 100MΩ • μF C<0.01μF : More than 10,000MΩ															
		Dielectric Strength	Pass the item No.4.															
			Fix the capacitor to the supporting jig (glass epoxy board) shown in Fig.4 using a eutectic solder. Perform the five cycles according to the four heat treatments listed in the following table. Let sit for 24±2 h at room condition, then measure. <table border="1" style="margin-left: auto; margin-right: auto; border-collapse: collapse;"> <thead> <tr> <th>Step</th> <th>Temperature (°C)</th> <th>Time (min)</th> </tr> </thead> <tbody> <tr> <td>1</td> <td>Min. Operating Temp.±3</td> <td>30±3</td> </tr> <tr> <td>2</td> <td>Room Temp.</td> <td>2 to 3</td> </tr> <tr> <td>3</td> <td>Max. Operating Temp.±2</td> <td>30±3</td> </tr> <tr> <td>4</td> <td>Room Temp.</td> <td>2 to 3</td> </tr> </tbody> </table> •Pretreatment Perform a heat treatment at 150 ± ₁ 8°C for 60±5 min and then let sit for 24±2 h at room condition.  Fig.4	Step	Temperature (°C)	Time (min)	1	Min. Operating Temp.±3	30±3	2	Room Temp.	2 to 3	3	Max. Operating Temp.±2	30±3	4	Room Temp.	2 to 3
Step	Temperature (°C)	Time (min)																
1	Min. Operating Temp.±3	30±3																
2	Room Temp.	2 to 3																
3	Max. Operating Temp.±2	30±3																
4	Room Temp.	2 to 3																
15	Humidity (Steady State)	Appearance	No marking defects.															
		Capacitance Change	Within ±15%															
		D.F.	0.05 max.															
		I.R.	C≥0.01μF : More than 10MΩ • μF C<0.01μF : More than 1,000MΩ															
		Dielectric Strength	Pass the item No.4.															
			Sit the capacitor at 40±2°C and relative humidity 90 to 95% for 500 ± ₂ 3 h. Remove and let sit for 24±2 h at room condition, then measure. •Pretreatment Perform a heat treatment at 150 ± ₁ 8°C for 60±5 min and then let sit for 24±2 h at room condition.															
16	Life	Appearance	No marking defects.															
		Capacitance Change	Within ±15%															
		D.F.	0.05 max.															
		I.R.	C≥0.01μF : More than 10MΩ • μF C<0.01μF : More than 1,000MΩ															
		Dielectric Strength	Pass the item No.4.															
			Apply 120% of the rated voltage (150% of the rated voltage in case of rated voltage: DC250V) for 1,000 ± ₄ 8 h at maximum operating temperature±3°C. Remove and let sit for 24 ±2 h at room condition, then measure. The charge/discharge current is less than 50mA. •Pretreatment Apply test voltage for 60±5 min at test temperature. Remove and let sit for 24±2 h at room condition.															
17	Humidity Loading	Appearance	No marking defects.															
		Capacitance Change	Within ±15%															
		D.F.	0.05 max.															
		I.R.	C≥0.01μF : More than 10MΩ • μF C<0.01μF : More than 1,000MΩ															
		Dielectric Strength	Pass the item No.4.															
			Apply the rated voltage at 40±2°C and relative humidity 90 to 95% for 500 ± ₂ 3 h. Remove and let sit for 24±2 h at room condition, then measure. •Pretreatment Apply test voltage for 60±5 min at test temperature. Remove and let sit for 24±2 h at room condition.															

"Room condition" Temperature : 15 to 35°C, Relative humidity : 45 to 75%, Atmosphere pressure : 86 to 106kPa

Chip Monolithic Ceramic Capacitors



AC250V(r.m.s.) Type

■ Features

1. Chip monolithic ceramic capacitor for AC line.
2. A new monolithic structure for small, high-capacitance capable of operating at high-voltage levels.
3. Sn-plated external electrodes realize good solderability.
4. Only for Reflow soldering.
5. Capacitance 0.01 to 0.1 uF for connecting lines and 470 to 4700 pF for connecting line to earth.

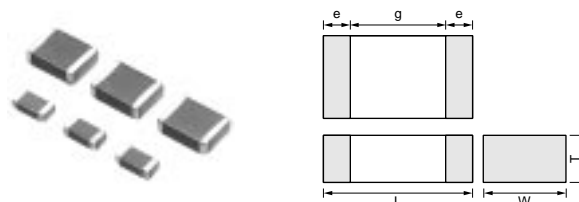

Part Number	Dimensions (mm)				
	L	W	T	e min.	g min.
GA252D	5.7 ±0.4	2.8 ±0.3	2.0 ±0.3	0.3	3.5
GA255D		5.0 ±0.4			

■ Applications

Noise suppression filters for switching power supplies, telephones, facsimiles, modems.

■ Reference standard

JIS C 5102

JIS C 5150

The standards of the electrical appliance and material control law of Japan, separated table 4.

Part Number	Rated Voltage (V)	TC Code	Capacitance	Length L (mm)	Width W (mm)	Thickness T (mm)	Electrode g (mm)	Electrode e (mm)
GA252DB3E2471MY02L	AC250 (r.m.s.)	B	470pF +20,-20%	5.7	2.8	2.0	3.5 min.	0.3 min.
GA252DB3E2102MY02L	AC250 (r.m.s.)	B	1000pF +20,-20%	5.7	2.8	2.0	3.5 min.	0.3 min.
GA252DB3E2222MY02L	AC250 (r.m.s.)	B	2200pF +20,-20%	5.7	2.8	2.0	3.5 min.	0.3 min.
GA252DB3E2472MY02L	AC250 (r.m.s.)	B	4700pF +20,-20%	5.7	2.8	2.0	3.5 min.	0.3 min.
GA252DB3E2103MY02L	AC250 (r.m.s.)	B	10000pF +20,-20%	5.7	2.8	2.0	3.5 min.	0.3 min.
GA252DB3E2223MY02L	AC250 (r.m.s.)	B	22000pF +20,-20%	5.7	2.8	2.0	3.5 min.	0.3 min.
GA252DB3E2473MY02L	AC250 (r.m.s.)	B	47000pF +20,-20%	5.7	2.8	2.0	3.5 min.	0.3 min.
GA255DB3E2104MY02L	AC250 (r.m.s.)	B	0.1μF +20,-20%	5.7	5.0	2.0	3.5 min.	0.3 min.

Specifications and Test Methods

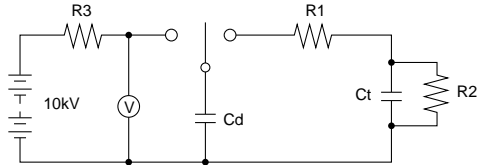
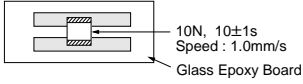
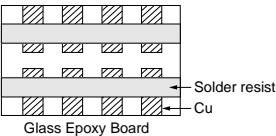
No.	Item	Specification	Test Method						
1	Operating Temperature Range	-25 to +85°C	-						
2	Appearance	No defects or abnormalities.	Visual inspection.						
3	Dimensions	Within the specified dimensions.	Using calipers.						
4	Dielectric Strength	No defects or abnormalities.	No failure shall be observed when voltage as table is applied between the terminations for 60±1 s, provided the charge/discharge current is less than 50mA. <table border="1" style="margin-left: auto; margin-right: auto;"> <thead> <tr> <th>Nominal Capacitance</th> <th>Test voltage</th> </tr> </thead> <tbody> <tr> <td>C≥10,000pF</td> <td>AC575V (r.m.s.)</td> </tr> <tr> <td>C<10,000pF</td> <td>AC1500V (r.m.s.)</td> </tr> </tbody> </table>	Nominal Capacitance	Test voltage	C≥10,000pF	AC575V (r.m.s.)	C<10,000pF	AC1500V (r.m.s.)
Nominal Capacitance	Test voltage								
C≥10,000pF	AC575V (r.m.s.)								
C<10,000pF	AC1500V (r.m.s.)								
5	Insulation Resistance (I.R.)	More than 2,000MΩ	The insulation resistance shall be measured with 500±50V and within 60±5 s of charging.						
6	Capacitance	Within the specified tolerance.	The capacitance/D.F. shall be measured at 20°C at a frequency of 1±0.2kHz and a voltage of 1±0.2V (r.m.s.)						
7	Dissipation Factor (D.F.)	0.025 max.							
8	Capacitance Temperature Characteristics	Cap. Change Within ±10%	The range of capacitance change compared with the 20°C value within -25 to +85°C shall be within the specified range. •Pretreatment Perform a heat treatment at 150±18°C for 60±5 min and then let sit for 24±2 h at room condition.						
9	Discharge Test (Application: Nominal Capacitance C<10,000pF)	Appearance No defects or abnormalities.	As in Fig., discharge is made 50 times at 5 s intervals from the capacitor(Cd) charged at DC voltage of specified.  Ct : Capacitor under test Cd : 0.001μF R1 : 1,000Ω R2 : 100MΩ R3 : Surge resistance						
10	Adhesive Strength of Termination	No removal of the terminations or other defects shall occur.	Solder the capacitor to the testing jig (glass epoxy board) shown in Fig.1 using a eutectic solder. Then apply 10N force in the direction of the arrow. The soldering shall be done either with an iron or using the reflow method and shall be conducted with care so that the soldering is uniform and free of defects such as heat shock.  Fig.1						
11	Vibration Resistance	Appearance	No defects or abnormalities.						
		Capacitance	Within the specified tolerance.						
	D.F.	0.025 max.	Solder the capacitor to the test jig (glass epoxy board). The capacitor shall be subjected to a simple harmonic motion having a total amplitude of 1.5mm, the frequency being varied uniformly between the approximate limits of 10 and 55Hz. The frequency range, from 10 to 55Hz and return to 10Hz, shall be traversed in approximately 1 min. This motion shall be applied for a period of 2 h in each 3 mutually perpendicular directions (total of 6 h). 						

"Room condition" Temperature : 15 to 35°C, Relative humidity : 45 to 75%, Atmosphere pressure : 86 to 106kPa

Continued on the following page.

Specifications and Test Methods

Continued from the preceding page.

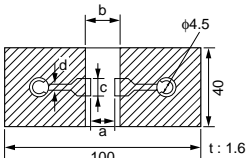
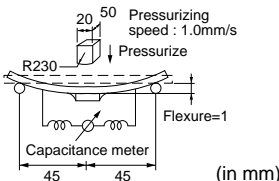
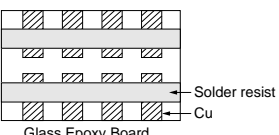
No.	Item	Specification	Test Method																		
12	Deflection	No cracking or marking defects shall occur.	<p>Solder the capacitor to the testing jig (glass epoxy board) shown in Fig.2 using a eutectic solder. Then apply a force in the direction shown in Fig. 3. The soldering shall be done either with an iron or using the reflow method and shall be conducted with care so that the soldering is uniform and free of defects such as heat shock.</p>  <table border="1" data-bbox="370 548 880 645"> <thead> <tr> <th rowspan="2">L×W (mm)</th> <th colspan="4">Dimension (mm)</th> </tr> <tr> <th>a</th> <th>b</th> <th>c</th> <th>d</th> </tr> </thead> <tbody> <tr> <td>5.7×2.8</td> <td>4.5</td> <td>8.0</td> <td>3.2</td> <td rowspan="2">1.0</td> </tr> <tr> <td>5.7×5.0</td> <td>4.5</td> <td>8.0</td> <td>5.6</td> </tr> </tbody> </table> <p style="text-align: center;">Fig.2</p>  <p style="text-align: center;">Fig.3</p>	L×W (mm)	Dimension (mm)				a	b	c	d	5.7×2.8	4.5	8.0	3.2	1.0	5.7×5.0	4.5	8.0	5.6
		L×W (mm)			Dimension (mm)																
a	b		c	d																	
5.7×2.8	4.5	8.0	3.2	1.0																	
5.7×5.0	4.5	8.0	5.6																		
13	Solderability of Termination	75% of the terminations are to be soldered evenly and continuously.	<p>Immerse the capacitor in a solution of ethanol (JIS-K-8101) and rosin (JIS-K-5902) (25% rosin in weight proportion). Immerse in eutectic solder solution for 2 ± 0.5 s at $235\pm 5^\circ\text{C}$. Immersing speed : 25 ± 2.5mm/s</p>																		
14	Humidity Insulation	Appearance	No marking defects.	<p>The capacitor shall be subjected to $40\pm 2^\circ\text{C}$, relative humidity of 90 to 98% for 8 h, and then removed in room condition for 16 h until 5 cycles.</p>																	
		Capacitance Change	Within $\pm 15\%$																		
		D.F.	0.05 max.																		
		I.R.	More than 1,000M Ω																		
		Dielectric Strength	Pass the item No.4.																		
15	Resistance to Soldering Heat	Appearance	No marking defects.	<p>Preheat the capacitor as table. Immerse the capacitor in eutectic solder solution at $260\pm 5^\circ\text{C}$ for 10 ± 1 s. Let sit at room condition for 24 ± 2 h, then measure. •Immersing speed : 25 ± 2.5mm/s •Pretreatment Perform a heat treatment at $150\pm 1.8^\circ\text{C}$ for 60 ± 5 min and then let sit for 24 ± 2 h at room condition.</p> <p>*Preheating</p> <table border="1" data-bbox="941 1243 1452 1321"> <thead> <tr> <th>Step</th> <th>Temperature</th> <th>Time</th> </tr> </thead> <tbody> <tr> <td>1</td> <td>100°C to 120°C</td> <td>1 min</td> </tr> <tr> <td>2</td> <td>170°C to 200°C</td> <td>1 min</td> </tr> </tbody> </table>	Step	Temperature	Time	1	100°C to 120°C	1 min	2	170°C to 200°C	1 min								
		Step	Temperature		Time																
		1	100°C to 120°C		1 min																
		2	170°C to 200°C		1 min																
		Capacitance Change	Within $\pm 10\%$																		
D.F.	0.025 max.																				
I.R.	More than 2,000M Ω																				
Dielectric Strength	Pass the item No.4.																				
16	Temperature Cycle	Appearance	No marking defects.	<p>Fix the capacitor to the supporting jig (glass epoxy board) shown in Fig.4 using a eutectic solder. Perform the five cycles according to the four heat treatments listed in the following table. Let sit for 24 ± 2 h at room condition, then measure.</p> <table border="1" data-bbox="941 1467 1452 1590"> <thead> <tr> <th>Step</th> <th>Temperature (°C)</th> <th>Time (min)</th> </tr> </thead> <tbody> <tr> <td>1</td> <td>Min. Operating Temp.±3</td> <td>30±3</td> </tr> <tr> <td>2</td> <td>Room Temp.</td> <td>2 to 3</td> </tr> <tr> <td>3</td> <td>Max. Operating Temp.±2</td> <td>30±3</td> </tr> <tr> <td>4</td> <td>Room Temp.</td> <td>2 to 3</td> </tr> </tbody> </table> <p>•Pretreatment Perform a heat treatment at $150\pm 1.8^\circ\text{C}$ for 60 ± 5 min and then let sit for 24 ± 2 h at room condition.</p>  <p style="text-align: center;">Fig.4</p>	Step	Temperature (°C)	Time (min)	1	Min. Operating Temp.±3	30±3	2	Room Temp.	2 to 3	3	Max. Operating Temp.±2	30±3	4	Room Temp.	2 to 3		
		Step	Temperature (°C)		Time (min)																
		1	Min. Operating Temp.±3		30±3																
		2	Room Temp.		2 to 3																
		3	Max. Operating Temp.±2		30±3																
4	Room Temp.	2 to 3																			
Capacitance Change	Within $\pm 7.5\%$																				
D.F.	0.025 max.																				
I.R.	More than 2,000M Ω																				
Dielectric Strength	Pass the item No.4.																				

"Room condition" Temperature : 15 to 35°C, Relative humidity : 45 to 75%, Atmosphere pressure : 86 to 106kPa

Continued on the following page. 

Specifications and Test Methods

 Continued from the preceding page.

No.	Item	Specification	Test Method									
17	Humidity (Steady State)	Appearance	No marking defects.									
		Capacitance Change	Within $\pm 15\%$									
		D.F.	0.05 max.									
		I.R.	More than 1,000M Ω									
		Dielectric Strength	Pass the item No.4.									
			Sit the capacitor at 40 $\pm 2^\circ\text{C}$ and relative humidity 90 to 95% for 500 $\pm 2\frac{3}{8}$ h. Remove and let sit for 24 ± 2 h at room condition, then measure. •Pretreatment Perform a heat treatment at 150 $\pm 1.8^\circ\text{C}$ for 60 ± 5 min and then let sit for 24 ± 2 h at room condition.									
18	Life	Appearance	No marking defects.									
		Capacitance Change	Within $\pm 15\%$									
		D.F.	0.05 max.									
		I.R.	More than 1,000M Ω									
		Dielectric Strength	Pass the item No.4.									
			Apply voltage and time as Table at 85 $\pm 2^\circ\text{C}$. Remove and let sit for 24 ± 2 h at room condition, then measure. The charge / discharge current is less than 50mA. <table border="1" style="margin-left: auto; margin-right: auto;"> <thead> <tr> <th>Nominal Capacitance</th> <th>Test Time</th> <th>Test voltage</th> </tr> </thead> <tbody> <tr> <td>$C \geq 10,000\text{pF}$</td> <td>1,000$\pm 4\frac{8}{8}$ h</td> <td>AC300V (r.m.s.)</td> </tr> <tr> <td>$C < 10,000\text{pF}$</td> <td>1,500$\pm 4\frac{8}{8}$ h</td> <td>AC500V (r.m.s.) *</td> </tr> </tbody> </table> * Except that once each hour the voltage is increased to AC1,000V (r.m.s.) for 0.1 s •Pretreatment Apply test voltage for 60 ± 5 min at test temperature. Remove and let sit for 24 ± 2 h at room condition.	Nominal Capacitance	Test Time	Test voltage	$C \geq 10,000\text{pF}$	1,000 $\pm 4\frac{8}{8}$ h	AC300V (r.m.s.)	$C < 10,000\text{pF}$	1,500 $\pm 4\frac{8}{8}$ h	AC500V (r.m.s.) *
Nominal Capacitance	Test Time	Test voltage										
$C \geq 10,000\text{pF}$	1,000 $\pm 4\frac{8}{8}$ h	AC300V (r.m.s.)										
$C < 10,000\text{pF}$	1,500 $\pm 4\frac{8}{8}$ h	AC500V (r.m.s.) *										
19	Humidity Loading	Appearance	No marking defects.									
		Capacitance Change	Within $\pm 15\%$									
		D.F.	0.05 max.									
		I.R.	More than 1,000M Ω									
		Dielectric Strength	Pass the item No.4.									
			Apply the rated voltage at 40 $\pm 2^\circ\text{C}$ and relative humidity 90 to 95% for 500 $\pm 2\frac{3}{8}$ h. Remove and let sit for 24 ± 2 h at room condition, then measure. •Pretreatment Apply test voltage for 60 ± 5 min at test temperature. Remove and let sit for 24 ± 2 h at room condition.									

"Room condition" Temperature : 15 to 35 $^\circ\text{C}$, Relative humidity : 45 to 75%, Atmosphere pressure : 86 to 106kPa

Chip Monolithic Ceramic Capacitors



Safety Standard Recognized Type

■ Features

1. Chip monolithic ceramic capacitor (certified as conforming to safety standards) for AC line.
2. A new monolithic structure for small, high-capacitance capable of operating at high-voltage levels.
3. Compared to lead type capacitors, this new capacitor is greatly downsized and low-profiled to 1/10 or less in volume, and 1/4 or less in height.
4. The type GB can be used as an X2-class capacitor.
5. The type GC can be used as an X1-class and Y2-class capacitor.
6. +125 degree C guaranteed.
7. Only for reflow soldering.

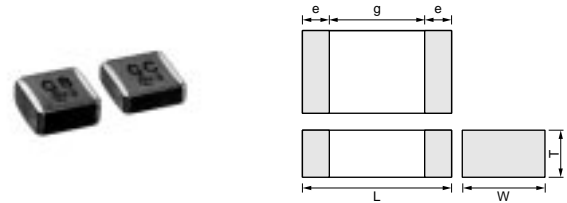

Part Number	Dimensions (mm)				
	L	W	T	e min.	g min.
GA355D	5.7 ±0.4	5.0 ±0.4	2.0 ±0.3	0.3	4.0
GA355X			2.7 ±0.3		

■ Applications

- Ideal use as Y capacitor or X capacitor for various switching power supply.
- Ideal use as linefilter for MODEM.

■ Standard Recognition

	Standard No.	Status of Recognition		Rated Voltage
		Type GB	Type GC	
UL	UL1414	—	◎*	AC250V (r.m.s.)
BSI	EN132400	—	◎	
VDE		◎	◎	
SEV		◎	◎	
SEMKO		◎	◎	
EN132400 Class		X2	X1, Y2	

* : Line By Pass only

Type GC

Part Number	Rated Voltage (V)	TC Code	Capacitance (pF)	Length L (mm)	Width W (mm)	Thickness T (mm)	Electrode g (mm)	Electrode e (mm)
GA355DR7GC101KY02L	AC250 (r.m.s.)	X7R	100 +10,-10%	5.7	5.0	2.0	4.0 min.	0.3 min.
GA355DR7GC151KY02L	AC250 (r.m.s.)	X7R	150 +10,-10%	5.7	5.0	2.0	4.0 min.	0.3 min.
GA355DR7GC221KY02L	AC250 (r.m.s.)	X7R	220 +10,-10%	5.7	5.0	2.0	4.0 min.	0.3 min.
GA355DR7GC331KY02L	AC250 (r.m.s.)	X7R	330 +10,-10%	5.7	5.0	2.0	4.0 min.	0.3 min.
GA355DR7GC471KY02L	AC250 (r.m.s.)	X7R	470 +10,-10%	5.7	5.0	2.0	4.0 min.	0.3 min.
GA355DR7GC681KY02L	AC250 (r.m.s.)	X7R	680 +10,-10%	5.7	5.0	2.0	4.0 min.	0.3 min.
GA355DR7GC102KY02L	AC250 (r.m.s.)	X7R	1000 +10,-10%	5.7	5.0	2.0	4.0 min.	0.3 min.
GA355DR7GC152KY02L	AC250 (r.m.s.)	X7R	1500 +10,-10%	5.7	5.0	2.0	4.0 min.	0.3 min.
GA355DR7GC222KY02L	AC250 (r.m.s.)	X7R	2200 +10,-10%	5.7	5.0	2.0	4.0 min.	0.3 min.
GA355DR7GC332KY02L	AC250 (r.m.s.)	X7R	3300 +10,-10%	5.7	5.0	2.0	4.0 min.	0.3 min.
GA355DR7GC472KY02L	AC250 (r.m.s.)	X7R	4700 +10,-10%	5.7	5.0	2.0	4.0 min.	0.3 min.

Type GB

Part Number	Rated Voltage (V)	TC Code	Capacitance (pF)	Length L (mm)	Width W (mm)	Thickness T (mm)	Electrode g (mm)	Electrode e (mm)
GA355DR7GB103KY02L	AC250 (r.m.s.)	X7R	10000 +10,-10%	5.7	5.0	2.0	4.0 min.	0.3 min.
GA355DR7GB153KY02L	AC250 (r.m.s.)	X7R	15000 +10,-10%	5.7	5.0	2.0	4.0 min.	0.3 min.
GA355DR7GB223KY02L	AC250 (r.m.s.)	X7R	22000 +10,-10%	5.7	5.0	2.0	4.0 min.	0.3 min.
GA355XR7GB333KY06L	AC250 (r.m.s.)	X7R	33000 +10,-10%	5.7	5.0	2.7	4.0 min.	0.3 min.

Specifications and Test Methods

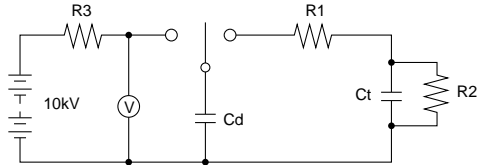
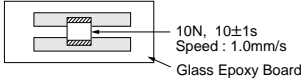
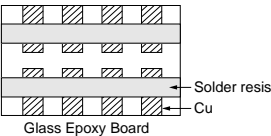
No.	Item	Specification	Test Method						
1	Operating Temperature Range	-55 to +125°C	-						
2	Appearance	No defects or abnormalities.	Visual inspection.						
3	Dimensions	Within the specified dimensions.	Using calipers.						
4	Dielectric Strength	No defects or abnormalities.	No failure shall be observed when voltage as table is applied between the terminations for 60±1 s, provided the charge/discharge current is less than 50mA. <table border="1" style="margin-left: auto; margin-right: auto;"> <thead> <tr> <th></th> <th>Test voltage</th> </tr> </thead> <tbody> <tr> <td>Type GB</td> <td>DC1075V</td> </tr> <tr> <td>Type GC</td> <td>AC1500V (r.m.s.)</td> </tr> </tbody> </table>		Test voltage	Type GB	DC1075V	Type GC	AC1500V (r.m.s.)
	Test voltage								
Type GB	DC1075V								
Type GC	AC1500V (r.m.s.)								
5	Insulation Resistance (I.R.)	More than 6,000MΩ	The insulation resistance shall be measured with 500±50V and within 60±5 s of charging.						
6	Capacitance	Within the specified tolerance.	The capacitance/D.F. shall be measured at 20°C at a frequency of 1±0.2kHz and a voltage of 1±0.2V (r.m.s.)						
7	Dissipation Factor (D.F.)	0.025 max.							
8	Capacitance Temperature Characteristics	Cap. Change Within ±15%	The range of capacitance change compared with the 25°C value within -55 to +125°C shall be within the specified range. •Pretreatment Perform a heat treatment at 150 ± 1°C for 60±5 min and then let sit for 24±2 h at room condition.						
9	Discharge Test (Application: Type GC)	Appearance	No defects or abnormalities.						
		I.R.	More than 1,000MΩ						
		Dielectric Strength	Pass the item No.4.						
			As in Fig., discharge is made 50 times at 5 s intervals from the capacitor(Cd) charged at DC voltage of specified.  Ct : Capacitor under test Cd : 0.001μF R1 : 1,000Ω R2 : 100MΩ R3 : Surge resistance						
10	Adhesive Strength of Termination	No removal of the terminations or other defect shall occur.	Solder the capacitor to the testing jig (glass epoxy board) shown in Fig.1 using a eutectic solder. Then apply 10N force in the direction of the arrow. The soldering shall be done either with an iron or using the reflow method and shall be conducted with care so that the soldering is uniform and free of defects such as heat shock.  Fig.1 10N, 10±1s Speed : 1.0mm/s Glass Epoxy Board						
11	Vibration Resistance	Appearance	No defects or abnormalities.						
		Capacitance	Within the specified tolerance.						
		D.F.	0.025 max.						
			Solder the capacitor to the test jig (glass epoxy board). The capacitor shall be subjected to a simple harmonic motion having a total amplitude of 1.5mm, the frequency being varied uniformly between the approximate limits of 10 and 55Hz. The frequency range, from 10 to 55Hz and return to 10Hz, shall be traversed in approximately 1 min. This motion shall be applied for a period of 2 h in each 3 mutually perpendicular directions (total of 6 h).  Solder resist Cu Glass Epoxy Board						

"Room condition" Temperature : 15 to 35°C, Relative humidity : 45 to 75%, Atmosphere pressure : 86 to 106kPa

Continued on the following page.

Specifications and Test Methods

Continued from the preceding page.

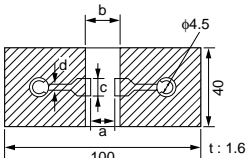
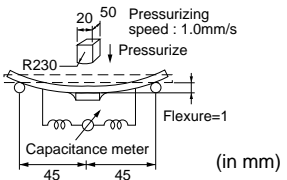
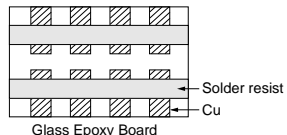
No.	Item	Specification	Test Method															
12	Deflection	No cracking or marking defects shall occur.	<p>Solder the capacitor to the testing jig (glass epoxy board) shown in Fig.2 using a eutectic solder. Then apply a force in the direction shown in Fig. 3. The soldering shall be done either with an iron or using the reflow method and shall be conducted with care so that the soldering is uniform and free of defects such as heat shock.</p>  <table border="1" data-bbox="375 548 885 627"> <thead> <tr> <th rowspan="2">L×W (mm)</th> <th colspan="4">Dimension (mm)</th> </tr> <tr> <th>a</th> <th>b</th> <th>c</th> <th>d</th> </tr> </thead> <tbody> <tr> <td>5.7×5.0</td> <td>4.5</td> <td>8.0</td> <td>5.6</td> <td>1.0</td> </tr> </tbody> </table> <p>Fig.2</p>	L×W (mm)	Dimension (mm)				a	b	c	d	5.7×5.0	4.5	8.0	5.6	1.0	
		L×W (mm)			Dimension (mm)													
a	b		c	d														
5.7×5.0	4.5	8.0	5.6	1.0														
			 <p>Fig.3</p>															
13	Solderability of Termination	75% of the terminations is to be soldered evenly and continuously.	<p>Immerse the capacitor in a solution of ethanol (JIS-K-8101) and rosin (JIS-K-5902) (25% rosin in weight proportion). Immerse in eutectic solder solution for 2±0.5 s at 235±5°C. Immersing speed : 25±2.5mm/s</p>															
14	Resistance to Soldering Heat	Appearance	No marking defects.															
		Capacitance Change	Within ±10%															
		I.R.	More than 1,000MΩ															
		Dielectric Strength	Pass the item No.4.															
			<p>Preheat the capacitor as table. Immerse the capacitor in eutectic solder solution at 260±5°C for 10±1 s. Let sit at room condition for 24±2 h, then measure.</p> <ul style="list-style-type: none"> •Immersing speed : 25±2.5mm/s •Pretreatment <p>Perform a heat treatment at 150 ± 1.8°C for 60±5 min and then let sit for 24±2 h at room condition.</p> <p>*Preheating</p> <table border="1" data-bbox="933 1019 1452 1097"> <thead> <tr> <th>Step</th> <th>Temperature</th> <th>Time</th> </tr> </thead> <tbody> <tr> <td>1</td> <td>100°C to 120°C</td> <td>1 min.</td> </tr> <tr> <td>2</td> <td>170°C to 200°C</td> <td>1 min.</td> </tr> </tbody> </table>	Step	Temperature	Time	1	100°C to 120°C	1 min.	2	170°C to 200°C	1 min.						
Step	Temperature	Time																
1	100°C to 120°C	1 min.																
2	170°C to 200°C	1 min.																
15	Temperature Cycle	Appearance	No marking defects.															
		Capacitance Change	Within ±15%															
		D.F.	0.05 max.															
		I.R.	More than 3,000MΩ															
		Dielectric Strength	Pass the item No.4.															
			<p>Fix the capacitor to the supporting jig (glass epoxy board) shown in Fig.4 using a eutectic solder. Perform the five cycles according to the four heat treatments listed in the following table. Let sit for 24±2 h at room condition, then measure.</p> <table border="1" data-bbox="933 1232 1452 1355"> <thead> <tr> <th>Step</th> <th>Temperature (°C)</th> <th>Time (min)</th> </tr> </thead> <tbody> <tr> <td>1</td> <td>Min. Operating Temp.±3</td> <td>30±3</td> </tr> <tr> <td>2</td> <td>Room Temp.</td> <td>2 to 3</td> </tr> <tr> <td>3</td> <td>Max. Operating Temp.±2</td> <td>30±3</td> </tr> <tr> <td>4</td> <td>Room Temp.</td> <td>2 to 3</td> </tr> </tbody> </table> <ul style="list-style-type: none"> •Pretreatment <p>Perform a heat treatment at 150 ± 1.8°C for 60±5 min and then let sit for 24±2 h at room condition.</p>  <p>Fig.4</p>	Step	Temperature (°C)	Time (min)	1	Min. Operating Temp.±3	30±3	2	Room Temp.	2 to 3	3	Max. Operating Temp.±2	30±3	4	Room Temp.	2 to 3
Step	Temperature (°C)	Time (min)																
1	Min. Operating Temp.±3	30±3																
2	Room Temp.	2 to 3																
3	Max. Operating Temp.±2	30±3																
4	Room Temp.	2 to 3																
16	Humidity (Steady State)	Appearance	No marking defects.															
		Capacitance Change	Within ±15%															
		D.F.	0.05 max.															
		I.R.	More than 3,000MΩ															
		Dielectric Strength	Pass the item No.4.															
			<p>Sit the capacitor at 40±2°C and relative humidity 90 to 95% for 500±12 h. Remove and let sit for 24±2 h at room condition, then measure.</p>															

"Room condition" Temperature : 15 to 35°C, Relative humidity : 45 to 75%, Atmosphere pressure : 86 to 106kPa

Continued on the following page. 

Specifications and Test Methods

 Continued from the preceding page.

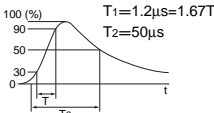
No.	Item	Specification	Test Method						
17	Life	Appearance	<p>Impulse Voltage</p> <p>Each individual capacitor shall be subjected to a 2.5kV (Type GC:5kV) Impulses (the voltage value means zero to peak) for three times. Then the capacitors are applied to life test.</p>  <p>Apply voltage as Table for 1,000 h at $125 \pm 2^{\circ}\text{C}$, relative humidity 50% max.</p> <table border="1" style="width: 100%;"> <thead> <tr> <th>Type</th> <th>Applied voltage</th> </tr> </thead> <tbody> <tr> <td>GB</td> <td>AC312.5V (r.m.s.), except that once each hour the voltage is increased to AC1,000V (r.m.s.) for 0.1s.</td> </tr> <tr> <td>GC</td> <td>AC425V (r.m.s.), except that once each hour the voltage is increased to AC1,000V (r.m.s.) for 0.1s.</td> </tr> </tbody> </table>	Type	Applied voltage	GB	AC312.5V (r.m.s.), except that once each hour the voltage is increased to AC1,000V (r.m.s.) for 0.1s.	GC	AC425V (r.m.s.), except that once each hour the voltage is increased to AC1,000V (r.m.s.) for 0.1s.
	Type	Applied voltage							
	GB	AC312.5V (r.m.s.), except that once each hour the voltage is increased to AC1,000V (r.m.s.) for 0.1s.							
	GC	AC425V (r.m.s.), except that once each hour the voltage is increased to AC1,000V (r.m.s.) for 0.1s.							
	Capacitance Change	Within $\pm 20\%$							
D.F.	0.05 max.								
I.R.	More than 3,000M Ω								
Dielectric Strength	Pass the item No.4.								
18	Humidity Loading	Appearance	<p>Apply the rated voltage at $40 \pm 2^{\circ}\text{C}$ and relative humidity 90 to 95% for 500 ± 2^4 h. Remove and let sit for 24 ± 2 h at room condition, then measure.</p>						
	Capacitance Change	Within $\pm 15\%$							
	D.F.	0.05 max.							
	I.R.	More than 3,000M Ω							
	Dielectric Strength	Pass the item No.4.							

"Room condition" Temperature : 15 to 35°C, Relative humidity : 45 to 75%, Atmosphere pressure : 86 to 106kPa

GRM/GA2/GA3 Series Data

■ Capacitance-Temperature Characteristics

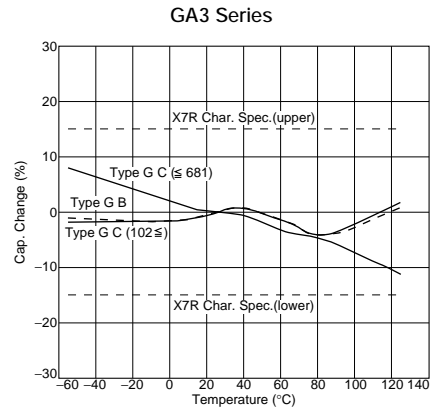
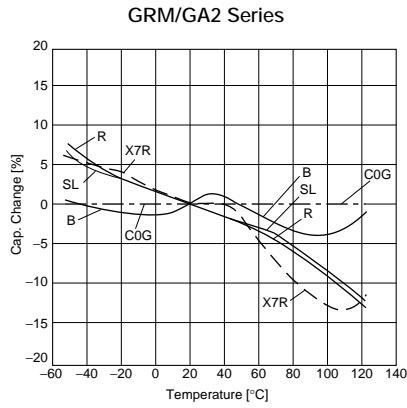

■ Impedance-Frequency Characteristics

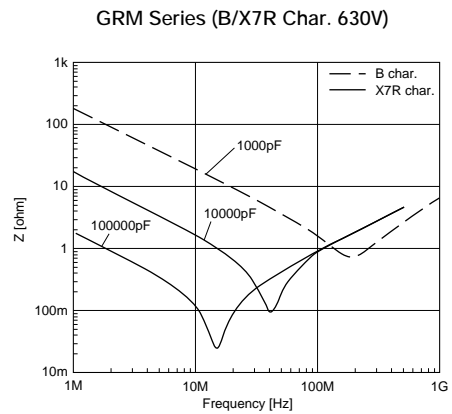
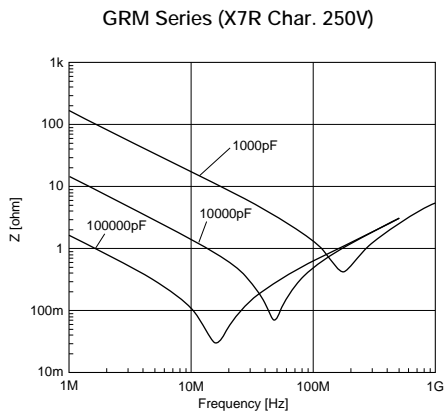
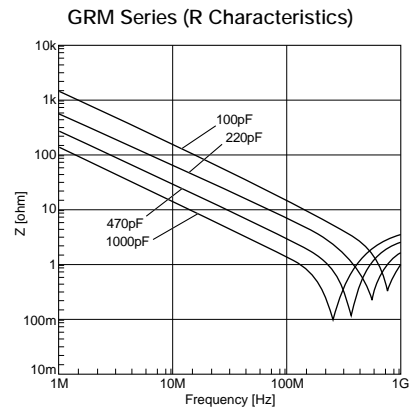
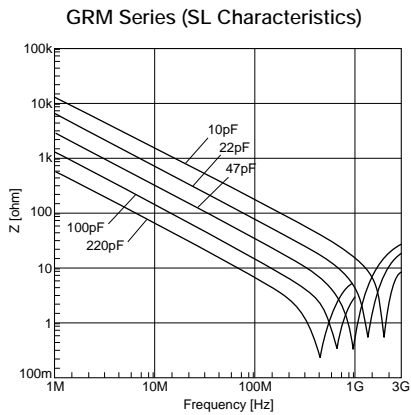

Continued on the following page.

GRM/GA2/GA3 Series Data

Continued from the preceding page.

Impedance-Frequency Characteristics

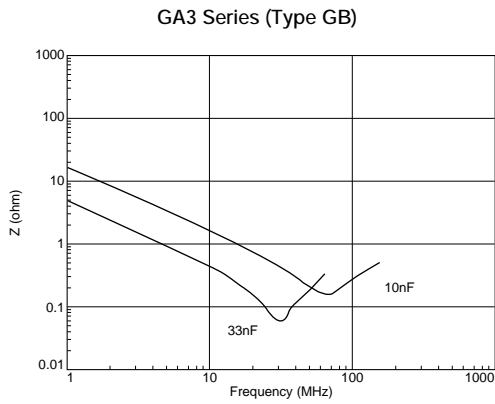
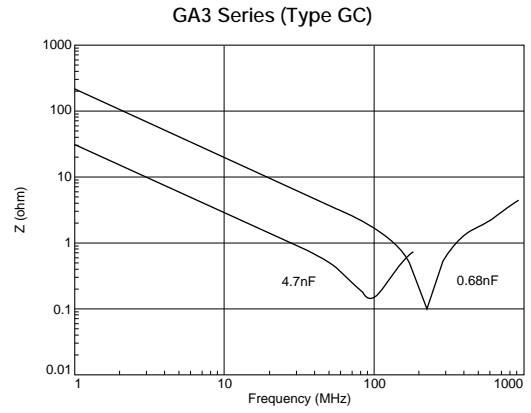
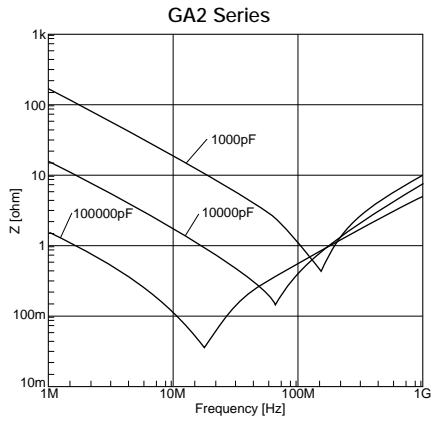

Capacitance-AC Voltage Characteristics

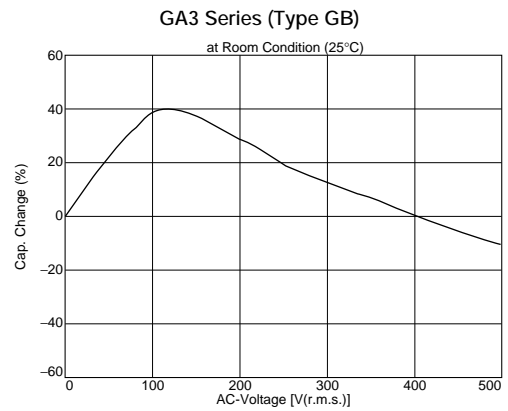
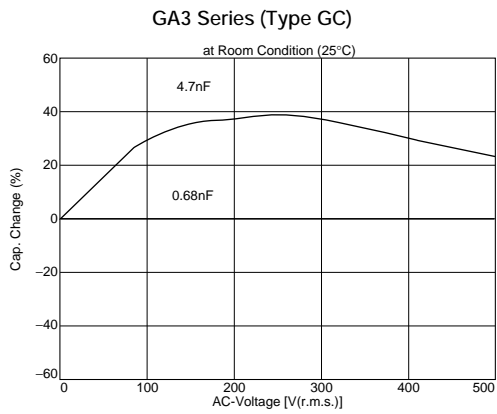

Package

Taping is standard packaging method.

■ Minimum Quantity Guide

Part Number		Dimensions (mm)			Quantity (pcs.)	
					φ180mm reel	
		L	W	T	Paper Tape	Plastic Tape
Medium-voltage	GRM21	2.0	1.25	1.0	4,000	-
				1.25	-	3,000
	GRM31	3.2	1.6	1.0	4,000	-
				1.25	-	3,000
				1.6	-	2,000
	GRM32	3.2	2.5	1.5	-	2,000
				2.0	-	1,000
	GRM42	4.5	2.0	2.0	-	2,000
				1.5	-	1,000
				2.0	-	1,000
2.5				-	500	
GRM43	4.5	3.2	2.6	-	500	
			2.0	-	1,000	
			2.5	-	500	
GRM55	5.7	5.0	2.0	-	1,000	
			2.7	-	500	
AC250V	GA252	5.7	2.8	2.0	-	1,000
	GA255	5.7	5.0	2.0	-	1,000
Safety Std. Recognition	GA355	5.7	5.0	2.0	-	1,000
				2.7	-	500

■ Tape Carrier Packaging

(1) Appearance of Taping

① Plastic Tape

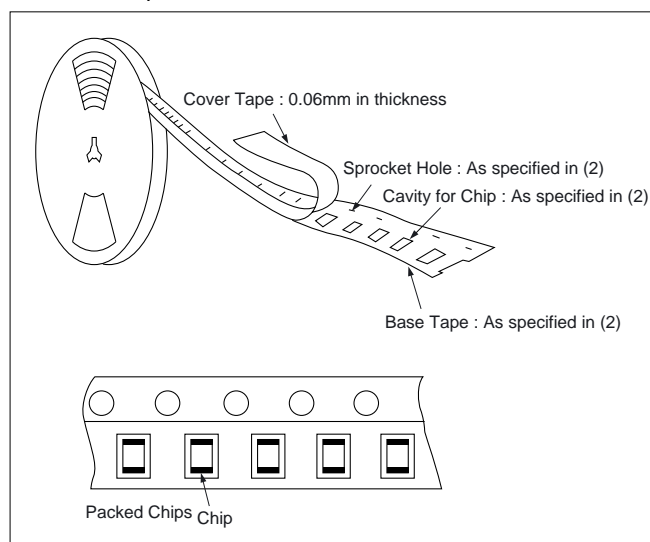

② Paper Tape

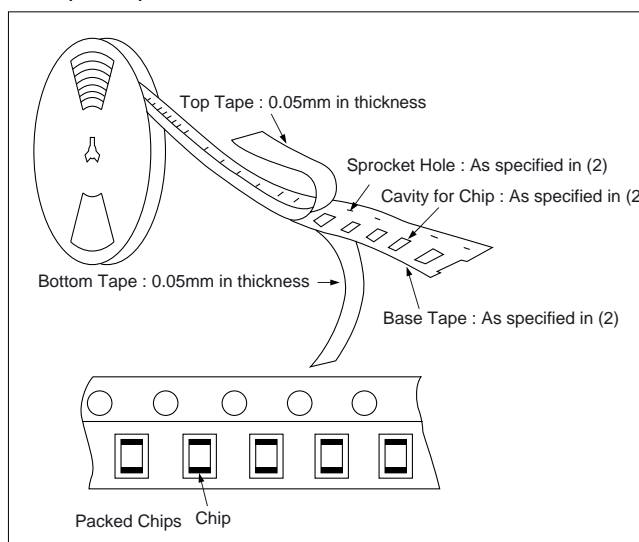

Continued on the following page.

Package

Continued from the preceding page.

(2) Dimensions of Tape

① Plastic Tape

8mm width 4mm pitch Tape ($T \geq 1.25$ rank)

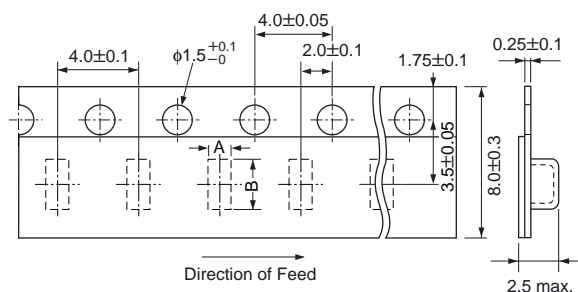

Part Number	A*	B*
GRM21	1.45	2.25
GRM31	2.0	3.6
GRM32	2.9	3.6

*Nominal Value

12mm width 8mm/4mm pitch Tape

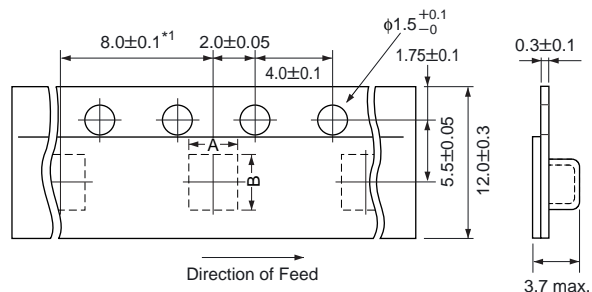

Part Number	A*	B*
GRM42	2.5	5.1
GRM43	3.6	4.9
GA252	3.2	6.1
GRM55		
GA255	5.4	6.1
GA355		

*1 4.0±0.1mm in case of GRM42

*Nominal Value

(in mm)

② Paper Tape

8mm width 4mm pitch Tape ($T=1.0$ rank)

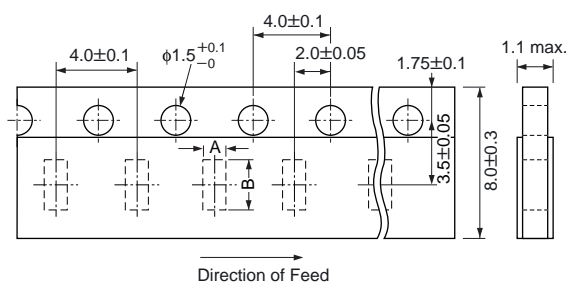

Part Number	A*	B*
GRM21	1.45	2.25
GRM31	2.0	3.6

*Nominal value
(in mm)

(3) Dimensions of Reel

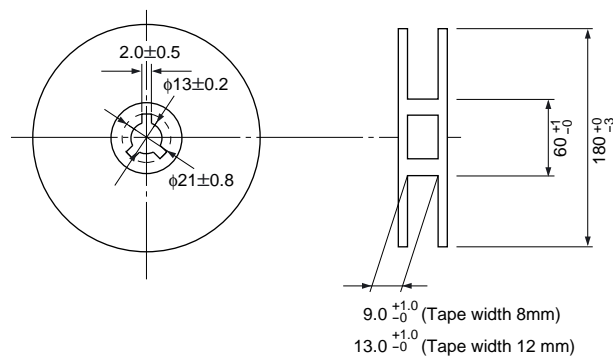

(in mm)

Continued on the following page.

Package

Continued from the preceding page.

(4) Taping Method

- ① Tapes for capacitors are wound clockwise. The sprocket holes are to the right as the tape is pulled toward the user.
- ② Part of the leader and part of the empty tape shall be attached to the end of the tape as right figure.
- ③ The top tape or cover tape and base tape are not attached at the end of the tape for a minimum of 5 pitches.
- ④ Missing capacitors number within 0.1% of the number per reel or 1 pc, whichever is greater, and are not continuous.
- ⑤ The top tape or cover tape and bottom tape shall not protrude beyond the edges of the tape and shall not cover sprocket holes.
- ⑥ Cumulative tolerance of sprocket holes, 10 pitches : $\pm 0.3\text{mm}$.
- ⑦ Peeling off force : 0.1 to 0.7N in the direction shown on the right.

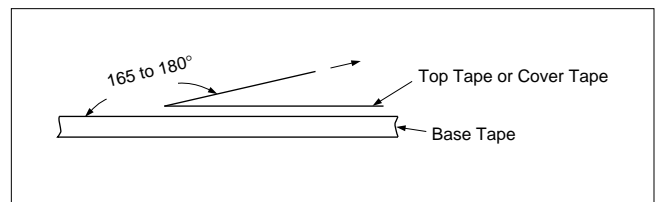
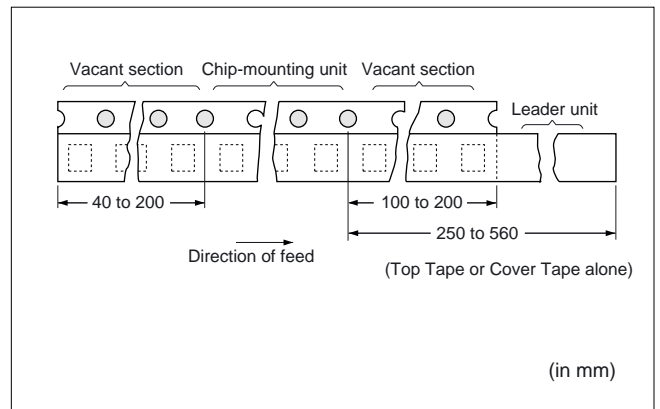



■ Storage and Operating Conditions

1. Operating and storage environment

Do not use or store capacitors in a corrosive atmosphere, especially where chloride gas, sulfide gas, acid, alkali, salt or the like are present and avoid exposure to moisture. Before cleaning, bonding or molding this product, verify that these processes do not affect product quality by testing the performance of a cleaned, bonded or molded product in

the intended equipment. Store the capacitors where the temperature and relative humidity do not exceed 5 to 40 degrees centigrade and 20 to 70%.

Use capacitors within 6 months. Confirm the solderability in case of 6 months or more.

Failure to follow the above cautions may result, worst case, in a short circuit and cause fuming or partial dispersion when the product is used.

■ Handling

1. Vibration and impact

Do not expose a capacitor to excessive shock or vibration during use.

Failure to follow the above cautions may result, worst case, in a short circuit and cause fuming or partial dispersion when the product is used.

Caution

Caution (Rating)

1. Operating Voltage

When DC-rated capacitors are to be used in AC or ripple current circuits, be sure to maintain the V_{p-p} value of the applied voltage or the V_{o-p} which contains DC bias within the rated voltage range.

When the voltage is started to apply to the circuit or it is stopped applying, the irregular voltage may be generated for a transit period because of resonance or switching. Be sure to use a capacitor within rated voltage containing these irregular voltage.

Voltage	DC Voltage	DC+AC Voltage	AC Voltage	Pulse Voltage (1)	Pulse Voltage (2)
Positional Measurement					

2. Operating Temperature and Self-generated Heat

(1) In case of B/X7R char.

Keep the surface temperature of a capacitor below the upper limit of its rated operating temperature range. Be sure to take into account the heat produced by the capacitor itself. When a capacitor is used in a high-frequency current, pulse current or the like, it may produce heat due to dielectric loss. Keep such self-generated temperature below 20°C. When measuring, use a thermocouple of small thermal capacity-K of $\phi 0.1$ mm and be in the condition where capacitor is not affected by radiant heat of other components and wind of surroundings. Excessive heat may lead to deterioration of the capacitor's characteristics and reliability.

(2) In case of C0G/R char.

Keep the surface temperature of a capacitor below the upper limit of its rated operating temperature range. Be sure to take into account the heat produced by the capacitor itself. When a capacitor is used in a high-frequency current, pulse current or the like, it may produce heat due to dielectric loss. The allowable frequency should be in less than 500kHz in sine wave. The applied voltage should be limited maximum 60% of the rated voltage (400Vp-p) : rated voltage : DC630V and maximum 70% of the rated voltage (700Vp-p) : rated voltage DC1kV at 500kHz in more than 10kHz domain as right figure. While, in case of non-sine wave which include a harmonic frequency, please contact our sales representatives or product engineers. The excessive heat may occur a deterioration of the electric characteristic or the reliability on a capacitor.

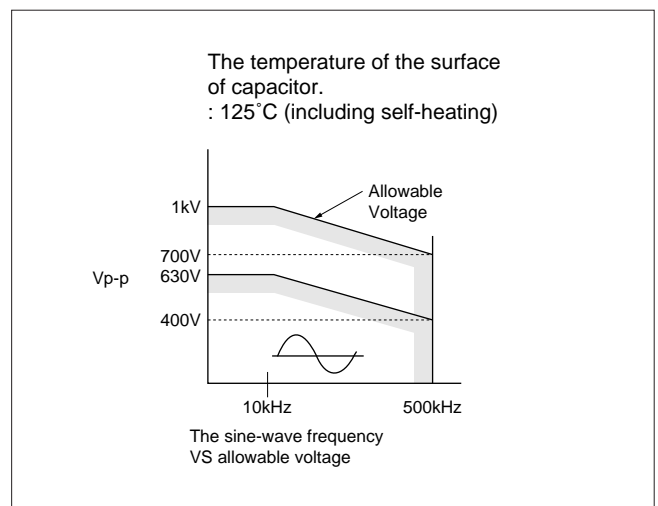

Continued on the following page.

Caution

Continued from the preceding page.

(3) In case of SL char.

Keep the surface temperature of a capacitor below the upper limit of its rated operating temperature range. Be sure to take into account the heat produced by the capacitor itself. When a capacitor is used in a high-frequency current, pulse current or the like, it may produce heat due to dielectric loss. The allowable frequency should be in less than 500kHz in sine wave. The applied voltage should be limited maximum 75% of the rated voltage(1.5kVp-p):rated voltage DC2kV and 55% of the rated voltage(1.75kVp-p):rated voltage DC3.15kV at 10kHz and maximum 40% of the rated voltage(800Vp-p):rated voltage DC2kV and 32% of the rated voltage(1.0kVp-p):rated voltage DC3.15kV at 500kHz respectively as right figure. While, in case of non-sine wave which include a harmonic frequency, please contact our sales representatives or product engineers. The excessive heat may occur a deterioration of the electric characteristic or the reliability on a capacitor.

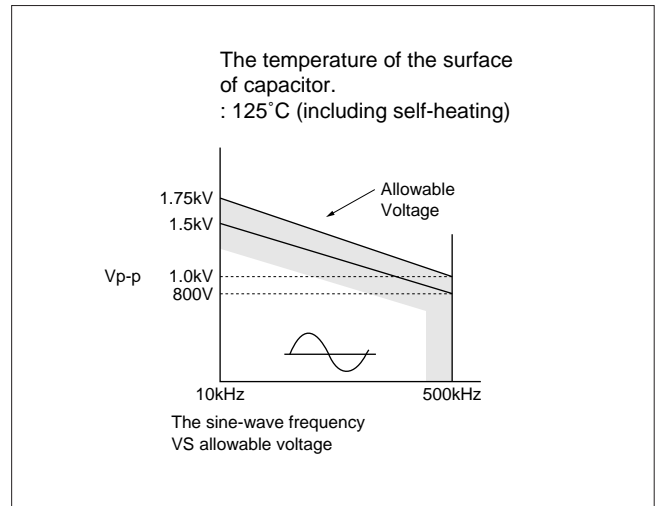

3. Test condition for AC withstanding Voltage

(1) Test Equipment

Test equipment for AC withstanding voltage shall be used with the performance of the wave similar to 50/60 Hz sine wave. If the distorted sine wave or over load exceeding the specified voltage value is applied, the defective may be caused.

(2) Voltage applied method

When the withstanding voltage is applied, capacitor's lead or terminal shall be firmly connected to the out-put of the withstanding voltage test equipment, and then the voltage shall be raised from near zero to the test voltage. If the test voltage without the raise from near zero voltage would be applied directly to capacitor, test voltage should be applied with the *zero cross. At the end of the test time, the test voltage shall be reduced to near zero, and then capacitor's lead or terminal shall be taken off the out-put of the withstanding voltage test equipment. If the test voltage without the raise from near zero voltage would be applied directly to capacitor, the surge voltage may arise, and therefore, the defective may be caused.

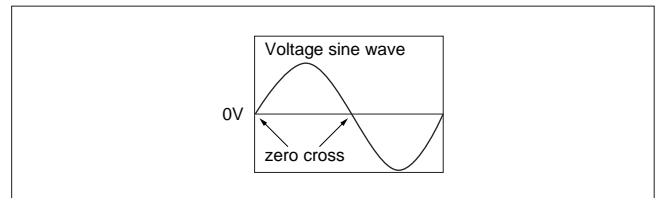

*ZERO CROSS is the point where voltage sine wave pass 0V.

- See the right figure -

Continued on the following page. ↗

⚠ Caution

☞ Continued from the preceding page.

4. Fail-Safe

When capacitor would be broken, failure may result in a short circuit. Be sure to provide an appropriate fail-safe function like a fuse on your product if failure would follow an electric shock, fire or fume.

Please be considered to use fuses on each AC lines in case that capacitors are used between AC input line to earth (line by-pass capacitor) preparing for the worst (short-circuit).

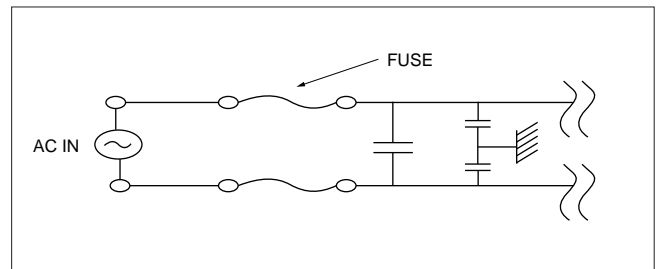

Failure to follow the above cautions may result, worst case, in a short circuit and cause fuming or partial dispersion when the product is used.

Caution

Caution (Soldering and Mounting)

1. Vibration and Impact

Do not expose a capacitor to excessive shock or vibration during use.

2. Circuit Board Material

Please contact our sales representatives or engineers in case that GR/GA products (size 4.5X3.2mm and over) are to be mounted upon a metal-board or metal-frame. Soldering heat causes the expansion and shrinkage of a board or frame. which may result in chip-cracking.

3. Land Layout for Cropping PC Board

Choose a mounting position that minimizes the stress imposed on the chip during flexing or bending of the board.

[Component Direction]

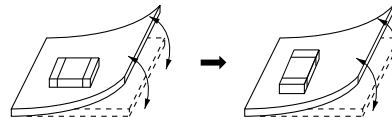

Locate chip horizontal to the direction in which stress acts.

[Chip Mounting Close to Board Separation Point]

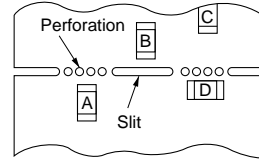

Chip arrangement Worst A>C>B=D Best

Continued on the following page. ↗

Caution

Continued from the preceding page.

4. Soldering (Prevention of the thermal shock)

If a chip component is heated or cooled abruptly during soldering, it may crack due to the thermal shock. To prevent this, adequate soldering condition should be taken following our recommendation below.

Carefully perform pre-heating so that temperature difference (ΔT) between the solder and component surface should be in the following range. When components are immersed in solvent after mounting, pay special attention to maintain the temperature difference within 100°C .

Chip Size	3.2×1.6mm and under	3.2×2.5mm and over
Soldering Method		
Reflow Method or Soldering Iron Method	$\Delta T \leq 190^{\circ}\text{C}$	$\Delta T \leq 130^{\circ}\text{C}$
Flow Method or Dip Soldering Method	$\Delta T \leq 150^{\circ}\text{C}$	—

When soldering chips with a soldering iron, it should be performed in following conditions.

Item	Conditions	
Chip Size	$\leq 2.0 \times 1.25\text{mm}$	$3.2 \times 1.6\text{mm}$
Temperature of Iron-tip	300°C max.	270°C max.
Soldering Iron Wattage	20W max.	
Diameter of Iron-tip	$\phi 3.0\text{mm}$ max.	
Soldering Time	3 sec. max.	
Caution	Do not allow the iron-tip to directly touch the ceramic element.	

Infrared Reflow Soldering Conditions (Example)

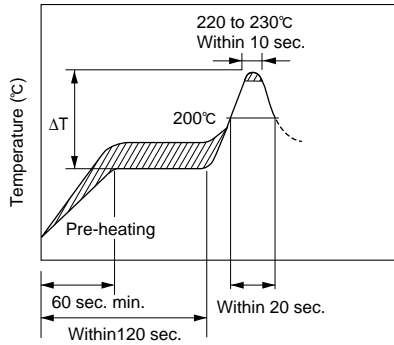

Vapor Reflow Soldering (VPS) Conditions (Example)

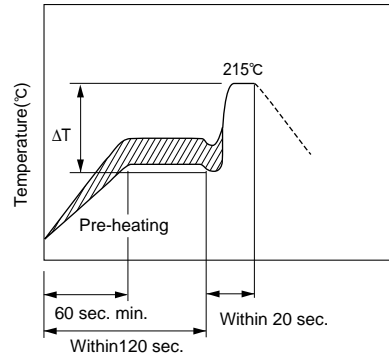

Flow Soldering Conditions (Example)

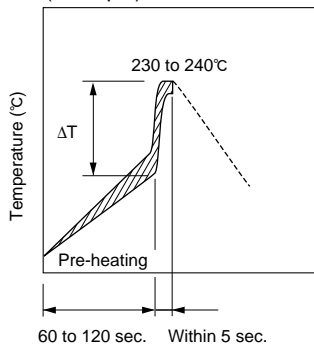

Dip Soldering/Soldering Iron Conditions (Example)

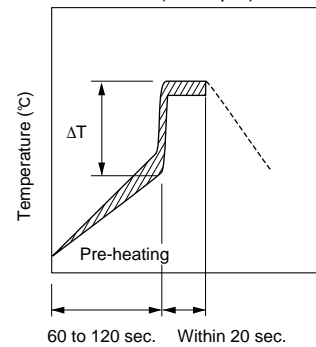

5. Soldering Method

GR/GA products whose sizes are $3.2 \times 1.6\text{mm}$ and under for flow and reflow soldering, and other sizes for reflow soldering.

Be sure to contact our sales representatives or engineers in case that GR/GA products (size $3.2 \times 2.5\text{mm}$ and over) are to be mounted with flow soldering. It may crack due to the thermal shock.

Failure to follow the above cautions may result, worst case, in a short circuit and fuming when the product is used.

Notice

■ Notice (Soldering and Mounting)

1. Mounting of Chips

● Mechanical shock of the chip placer

When the positioning claws and pick up nozzle are worn, the load is applied to the chip while positioning is concentrated to one position, thus causing cracks, breakage, faulty positioning accuracy, etc.

Careful checking and maintenance are necessary to prevent unexpected trouble.

An excessively low bottom dead point of the suction nozzle imposes great force on the chip during mounting, causing cracked chips. Please set the suction nozzle's bottom dead point on the upper surface of the board.

Termination Thickness of Chip Capacitor and Desirable Thickness of Adhesives Applied

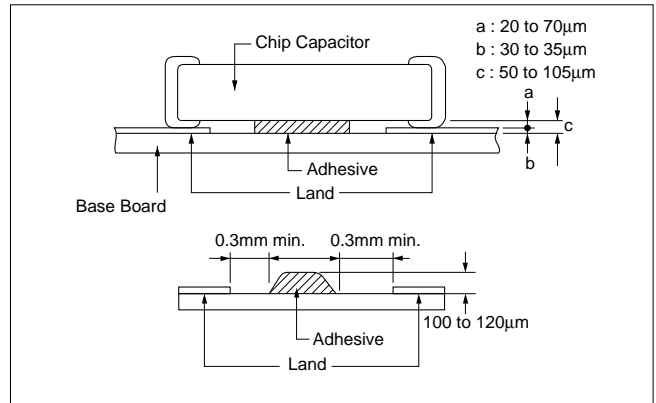

2. Construction of Board Pattern

After installing chips, if solder is excessively applied to the circuit board, mechanical stress will cause destruction resistance characteristics to lower. To prevent this, be extremely careful in determining shape and dimension before designing the circuit board diagram.

Construction and Dimensions of Pattern (Example)

Preparing slit help flux cleaning and resin coating on the back of the capacitor.

Flow Soldering

L×W	a	b	c
2.0×1.25	1.0-1.2	0.9-1.0	0.8-1.1
3.2×1.6	2.2-2.6	1.0-1.1	1.0-1.4

Reflow Soldering

L×W	a	b	c	d	e
2.0×1.25	1.0-1.2	0.9-1.0	0.8-1.1	-	-
3.2×1.6	2.2-2.4	0.8-0.9	1.0-1.4	1.0-2.0	3.2-3.7
3.2×2.5	2.0-2.4	1.0-1.2	1.8-2.3	1.0-2.0	4.1-4.6
4.5×2.0	2.8-3.4	1.2-1.4	1.4-1.8	1.0-2.8	3.6-4.1
4.5×3.2	2.8-3.4	1.2-1.4	2.3-3.0	1.0-2.8	4.8-5.3
5.7×2.8	4.0-4.6	1.4-1.6	2.1-2.6	1.0-4.0	4.4-4.9
5.7×5.0	4.0-4.6	1.4-1.6	3.5-4.8	1.0-4.0	6.6-7.1

(in mm)

Land Layout to Prevent Excessive Solder

	Mounting Close to a Chassis	Mounting with Leaded Components	Mounting Leaded Components Later
Examples of Arrangements to be Avoided	<p style="text-align: right;">in section</p>	<p style="text-align: right;">in section</p>	<p style="text-align: right;">in section</p>
Examples of Improvements by the Land Division	<p style="text-align: right;">in section</p>	<p style="text-align: right;">in section</p>	<p style="text-align: right;">in section</p>

Continued on the following page.

Notice

 Continued from the preceding page.

3. Soldering

(Care for minimizing loss of the terminations.)

Limit of losing effective area of the terminations and conditions needed for soldering.

Depending on the conditions of the soldering temperature and/or immersion (melting time), effective areas may be lost in some part of the terminations.

To prevent this, be careful in soldering so that any possible loss of the effective area on the terminations will securely remain minimum 25% on all edge length A-B-C-D of part with A, B, C, D, shown in the Figure below.

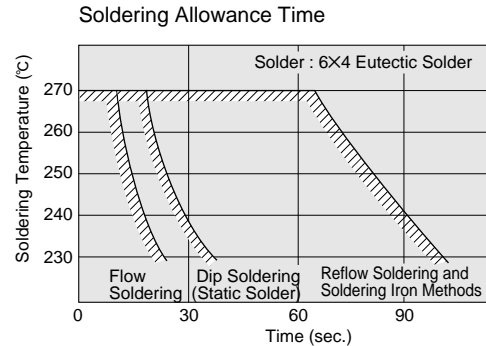
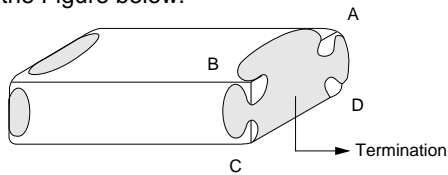

In case of repeated soldering, the accumulated soldering time must be within the range shown above.

(2) Flux

- Use rosin-type flux and do not use a highly acidic flux (any containing a minimum of 0.2wt% chlorine).

(3) Solder Buildup

① Flow soldering and iron soldering

Use as little solder as possible, and confirm that the solder is securely placed.

[Solder Buildup by Flow Method and Soldering Iron Method]

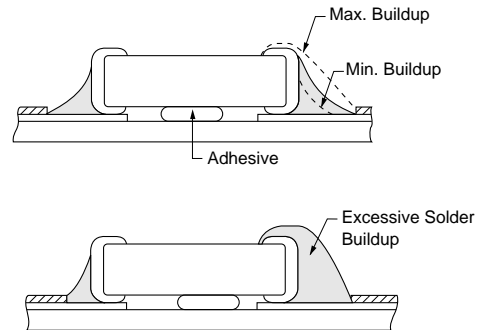

② Reflow soldering

When soldering, confirm that the solder is placed over 0.2mm of the surface of the terminations.

[Solder Buildup by Reflow Method]

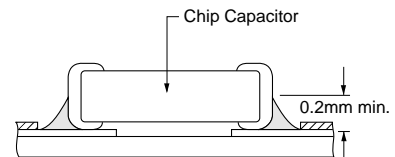

4. Cleaning

To perform ultrasonic cleaning, observe the following conditions on the right.

Rinse bath capacity : Output of 20 watts per liter or less.
Rinsing time : 5 minutes maximum.

5. Resin Coating

- When selecting resin materials, select those with low contraction and low moisture absorption coefficient (generally epoxy resin is used).
- Buffer coat can decrease the influence of the resin shrinking (generally silicone resin).

Notice

■ Notice (Rating)

Capacitance change of capacitor

1. Class 1 capacitors

Capacitance might change a little depending on a surrounding temperature or an applied voltage.

Please contact us if you use for the strict time constant circuit.

2. Class 2 and 3 capacitors

Class 2 and 3 capacitors like temperature characteristic B, E and F have an aging

characteristic, whereby the capacitor continually decreases its capacitance slightly if the capacitor leaves for a long time. Moreover, capacitance might change greatly depending on a surrounding temperature or an applied voltage. So, it is not likely to be able to use for the time constant circuit. Please contact us if you need a detail information.

ISO 9000 Certifications

Plant	Certified Date	Organization	Registration No.
Fukui Murata Manufacturing Co., Ltd.	Apr. 2, '97	UL *1 ISO9001	A5287
Izumo Murata Manufacturing Co., Ltd.	Jul. 25, '97		A5587
Murata Electronics Singapore (Pte.) Ltd.	Nov. 3, '99	PSB *2 ISO9001	99-2-1085
Murata Manufacturing (UK) Ltd.	Jun. 24, '98	BSI *3 ISO9001	FM 22169
Murata Amazonia Industria Comercio Ltda.	Jul. 28, '98	FUNDACAO VANZOLINI ISO9002	SQ-480-675/98
Murata Electronics North America State College Plant	Mar. 7, '96	UL *1 ISO9001	A1734
Beijing Murata Electronics Co., Ltd.	Dec. 10, '98	UL *1 ISO9002	A7123

*1 UL : Underwriters Laboratories Inc.

*2 PSB : Singapore Productivity and Standards Board

*3 BSI : British Standards Institution

⚠ Note:

1. Export Control

⟨For customers outside Japan⟩

Murata products should not be used or sold for use in the development, production, stockpiling or utilization of any conventional weapons or mass-destructive weapons (nuclear weapons, chemical or biological weapons, or missiles), or any other weapons.

⟨For customers in Japan⟩

For products which are controlled items subject to the "Foreign Exchange and Foreign Trade Law" of Japan, the export license specified by the law is required for export.

2. Please contact our sales representatives or product engineers before using our products listed in this catalog for the applications listed below which require especially high reliability for the prevention of defects which might directly cause damage to the third party's life, body or property, or when intending to use one of our products for other applications than specified in this catalog.

- ① Aircraft equipment
- ② Aerospace equipment
- ③ Undersea equipment
- ④ Power plant equipment
- ⑤ Medical equipment
- ⑥ Transportation equipment (vehicles, trains, ships, etc.)
- ⑦ Traffic signal equipment
- ⑧ Disaster prevention / crime prevention equipment
- ⑨ Data-processing equipment
- ⑩ Application of similar complexity and/or reliability requirements to the applications listed in the above

3. Product specifications in this catalog are as of May 2001. They are subject to change or our products in it may be discontinued without advance notice. Please check with our sales representatives or product engineers before your ordering. If there are any questions, please contact our sales representatives or product engineers.

4. Please read CAUTION and Notice in this catalog for safety. This catalog has only typical specifications. Therefore you are requested to approve our product specification or to transact the approval sheet for product specification, before your ordering.

5. Please note that unless otherwise specified, we shall assume no responsibility whatsoever for any conflict or dispute that may occur in connection with the effect of our and/or third party's intellectual property rights and other related rights in consideration of your using our products and/or information described or contained in our catalogs. In this connection, no representation shall be made to the effect that any third parties are authorized to use the rights mentioned above under licenses without our consent.

6. None of ozone depleting substances (ODS) under the Montreal Protocol is used in manufacturing process of us.