

Preliminary datasheet

EasyPACK™ module with CoolSiC™ Trench MOSFET and PressFIT / NTC

Features

- Electrical features
 - $V_{DSS} = 1200\text{ V}$
 - $I_{DN} = 25\text{ A} / I_{DRM} = 50\text{ A}$
 - High current density
 - Low inductive design
 - Low switching losses
- Mechanical features
 - Rugged mounting due to integrated mounting clamps
 - Integrated NTC temperature sensor
 - PressFIT contact technology

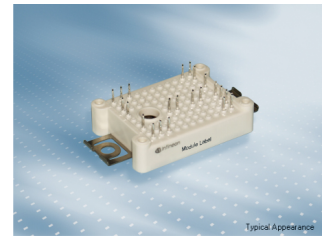

Potential applications

- DC/DC converter
- High Frequency Switching application
- Welding
- DC charger for EV

Product validation

- Qualified for industrial applications according to the relevant tests of IEC 60747, 60749 and 60068

Description

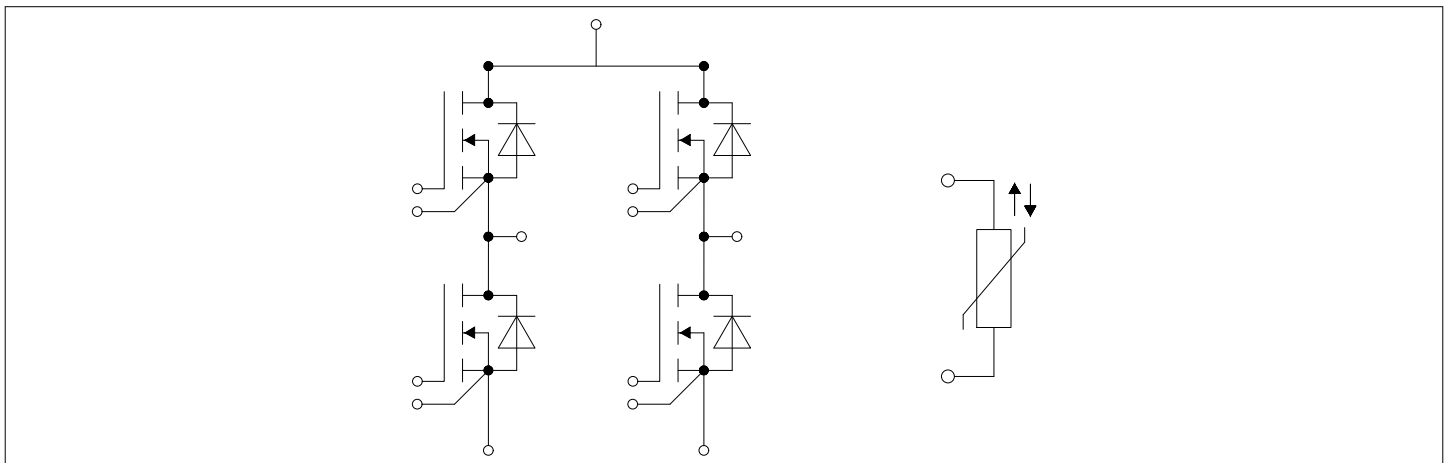

Table of contents

	Description	1
	Features	1
	Potential applications	1
	Product validation	1
	Table of contents	2
1	Package	3
2	MOSFET	3
3	Body diode	5
4	NTC-Thermistor	5
5	Characteristics diagrams	6
6	Circuit diagram	9
7	Package outlines	10
8	Module label code	11
	Disclaimer	12

1 Package

Table 1 Insulation Coordination

Parameter	Symbol	Note or test condition	Values	Unit
Isolation test voltage	V_{ISOL}	RMS, $f = 50$ Hz, $t = 1$ min	3.0	kV
Internal Isolation		basic insulation (class 1, IEC 61140)	Al_2O_3	
Creepage distance	d_{Creep}	terminal to heatsink	11.5	mm
Creepage distance	d_{Creep}	terminal to terminal	6.3	mm
Clearance	d_{Clear}	terminal to heatsink	10.0	mm
Clearance	d_{Clear}	terminal to terminal	5.0	mm
Comparative tracking index	CTI		> 200	
RTI Elec.	RTI	housing	140	°C

Table 2 Characteristic Values

Parameter	Symbol	Note or test condition	Values			Unit
			Min.	Typ.	Max.	
Stray inductance module	L_{SCE}			14		nH
Storage temperature	T_{stg}		-40		125	°C
Mounting force per clamp	F		20		50	N
Weight	G			24		g

Note: The current under continuous operation is limited to 25 A rms per connector pin.

Important note: The selection of positive and negative gate-source voltages impacts the long-term behavior of the device. The design guidelines described in Application Note AN 2018-09 must be considered to ensure sound operation of the device over the planned lifetime.

2 MOSFET

Table 3 Maximum Rated Values

Parameter	Symbol	Note or test condition	Values	Unit
Drain-source voltage	V_{DSS}	$T_{vj} = 25$ °C	1200	V
Implemented drain current	I_{DN}		25	A
Continuous DC drain current	I_{DDC}	$T_{vj} = 175$ °C, $V_{GS} = 15$ V $T_H = 65$ °C	25	A
Repetitive peak drain current	I_{DRM}	verified by design, t_p limited by T_{vjmax}	50	A
Gate-source voltage	V_{GSS}		-10/+20	V

Table 4 Characteristic Values

Parameter	Symbol	Note or test condition	Values			Unit
			Min.	Typ.	Max.	
Drain-source on resistance	$R_{DS(on)}$	$I_D = 25\text{ A}, V_{GS} = 15\text{ V}$ $T_{vj} = 25\text{ °C}$ $T_{vj} = 125\text{ °C}$ $T_{vj} = 150\text{ °C}$		45		mΩ
				59		
				66		
Gate threshold voltage	$V_{GS(th)}$	$I_D = 10\text{ mA}, V_{DS} = V_{GS}, T_{vj} = 25\text{ °C}$, (tested after 1ms pulse at $V_{GS} = +20\text{ V}$)	3.45	4.5	5.55	V
Total gate charge	Q_G	$V_{DS} = 800\text{ V}, V_{GS} = -5/+15\text{ V}$		0.062		μC
Internal gate resistor	R_{Gint}	$T_{vj} = 25\text{ °C}$		4		Ω
Input capacitance	C_{ISS}	$f = 1\text{ MHz}, V_{DS} = 800\text{ V}, V_{GS} = 0\text{ V}$ $T_{vj} = 25\text{ °C}$		1.84		nF
Output capacitance	C_{OSS}	$f = 1\text{ MHz}, V_{DS} = 800\text{ V}, V_{GS} = 0\text{ V}$ $T_{vj} = 25\text{ °C}$		0.11		nF
Reverse transfer capacitance	C_{rss}	$f = 1\text{ MHz}, V_{DS} = 800\text{ V}, V_{GS} = 0\text{ V}$ $T_{vj} = 25\text{ °C}$		0.014		nF
C_{OSS} stored energy	E_{OSS}	$V_{DS} = 800\text{ V}, V_{GS} = -5/+15\text{ V}, T_{vj} = 25\text{ °C}$		44		μJ
Drain-source leakage current	I_{DSS}	$V_{DS} = 1200\text{ V}, V_{GS} = -5\text{ V}$ $T_{vj} = 25\text{ °C}$		0.1	120	μA
Gate-source leakage current	I_{GSS}	$V_{DS} = 0\text{ V}, T_{vj} = 25\text{ °C}$ $V_{GS} = 20\text{ V}$			400	nA
Turn-on delay time (inductive load)	t_{don}	$I_D = 25\text{ A}, R_{Gon} = 7.5\text{ Ω}, V_{DS} = 600\text{ V}, V_{GS} = -5/+15\text{ V}$ $T_{vj} = 25\text{ °C}$ $T_{vj} = 125\text{ °C}$ $T_{vj} = 150\text{ °C}$		19		ns
				19		
				19		
Rise time (inductive load)	t_r	$I_D = 25\text{ A}, R_{Gon} = 7.5\text{ Ω}, V_{DS} = 600\text{ V}, V_{GS} = -5/+15\text{ V}$ $T_{vj} = 25\text{ °C}$ $T_{vj} = 125\text{ °C}$ $T_{vj} = 150\text{ °C}$		9		ns
				8		
				8		
Turn-off delay time (inductive load)	t_{doff}	$I_D = 25\text{ A}, R_{Goff} = 3.9\text{ Ω}, V_{DS} = 600\text{ V}, V_{GS} = -5/+15\text{ V}$ $T_{vj} = 25\text{ °C}$ $T_{vj} = 125\text{ °C}$ $T_{vj} = 150\text{ °C}$		39		ns
				42		
				43		
Fall time (inductive load)	t_f	$I_D = 25\text{ A}, R_{Goff} = 3.9\text{ Ω}, V_{DS} = 600\text{ V}, V_{GS} = -5/+15\text{ V}$ $T_{vj} = 25\text{ °C}$ $T_{vj} = 125\text{ °C}$ $T_{vj} = 150\text{ °C}$		16		ns
				16		
				16		
Turn-on energy loss per pulse	E_{on}	$I_D = 25\text{ A}, V_{DS} = 600\text{ V}, L_\sigma = 35\text{ nH}, V_{GS} = -5/+15\text{ V}, R_{Gon} = 7.5\text{ Ω}, di/dt = 2.3\text{ kA/}\mu\text{s}$ ($T_{vj} = 150\text{ °C}$) $T_{vj} = 25\text{ °C}$ $T_{vj} = 125\text{ °C}$ $T_{vj} = 150\text{ °C}$		0.313		mJ
				0.368		
				0.388		

Table 4 Characteristic Values (continued)

Parameter	Symbol	Note or test condition	Values			Unit
			Min.	Typ.	Max.	
Turn-off energy loss per pulse	E_{off}	$I_D = 25\text{ A}$, $V_{DS} = 600\text{ V}$, $L_\sigma = 35\text{ nH}$, $V_{GS} = -5/+15\text{ V}$, $R_{Goff} = 3.9\ \Omega$, $dv/dt = 38.2\text{ kV}/\mu\text{s}$ ($T_{vj} = 150\text{ }^\circ\text{C}$)		$T_{vj} = 25\text{ }^\circ\text{C}$	0.07	mJ
				$T_{vj} = 125\text{ }^\circ\text{C}$	0.071	
				$T_{vj} = 150\text{ }^\circ\text{C}$	0.071	
Thermal resistance, junction to heatsink	R_{thJH}	per MOSFET		1.82		K/W
Temperature under switching conditions	$T_{vj\text{op}}$		-40		150	$^\circ\text{C}$

3 Body diode

Table 5 Maximum Rated Values

Parameter	Symbol	Note or test condition	Values	Unit
DC body diode forward current	I_{SD}	$T_{vj} = 175\text{ }^\circ\text{C}$, $V_{GS} = -5\text{ V}$ $T_H = 65\text{ }^\circ\text{C}$	8	A

Table 6 Characteristic Values

Parameter	Symbol	Note or test condition	Values			Unit	
			Min.	Typ.	Max.		
Forward voltage	V_{SD}	$I_{SD} = 25\text{ A}$, $V_{GS} = -5\text{ V}$		$T_{vj} = 25\text{ }^\circ\text{C}$	4.6	5.65	V
				$T_{vj} = 125\text{ }^\circ\text{C}$	4.35		
				$T_{vj} = 150\text{ }^\circ\text{C}$	4.3		

4 NTC-Thermistor

Table 7 Characteristic Values

Parameter	Symbol	Note or test condition	Values			Unit
			Min.	Typ.	Max.	
Rated resistance	R_{25}	$T_{NTC} = 25\text{ }^\circ\text{C}$		5		k Ω
Deviation of R_{100}	$\Delta R/R$	$T_{NTC} = 100\text{ }^\circ\text{C}$, $R_{100} = 493\ \Omega$	-5		5	%
Power dissipation	P_{25}	$T_{NTC} = 25\text{ }^\circ\text{C}$			20	mW
B-value	$B_{25/50}$	$R_2 = R_{25} \exp[B_{25/50}(1/T_2 - 1/(298,15\text{ K}))]$		3375		K
B-value	$B_{25/80}$	$R_2 = R_{25} \exp[B_{25/80}(1/T_2 - 1/(298,15\text{ K}))]$		3411		K
B-value	$B_{25/100}$	$R_2 = R_{25} \exp[B_{25/100}(1/T_2 - 1/(298,15\text{ K}))]$		3433		K

Note: Specification according to the valid application note.

5 Characteristics diagrams

output characteristic (typical), MOSFET

$$I_D = f(V_{DS})$$

$$V_{GS} = 15 \text{ V}$$

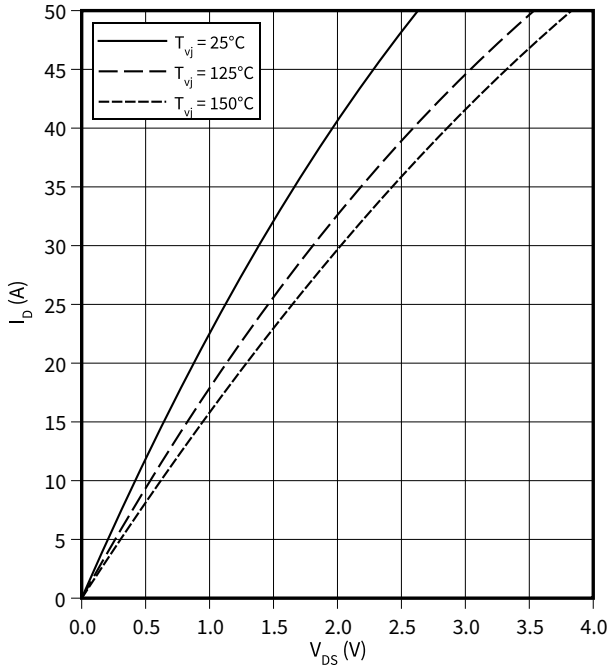

output characteristic (typical), MOSFET

$$I_D = f(V_{DS})$$

$$T_{vj} = 150^\circ\text{C}$$

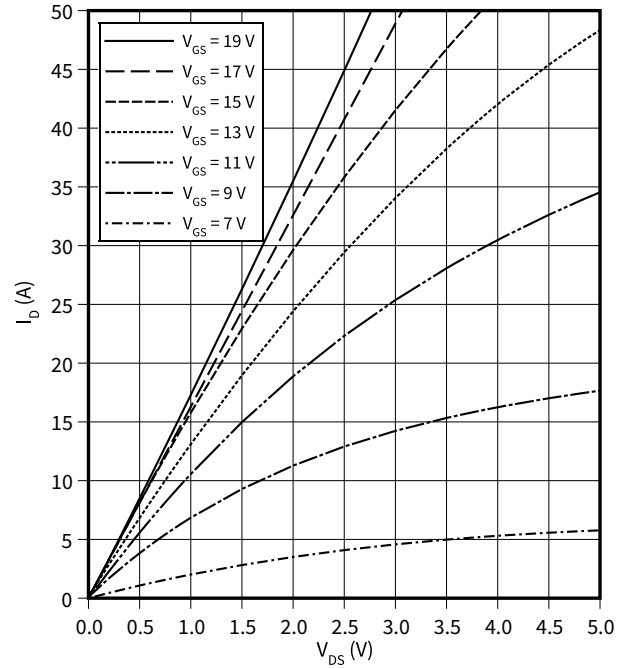

transfer characteristic (typical), MOSFET

$$I_D = f(V_{GS})$$

$$V_{DS} = 20 \text{ V}$$

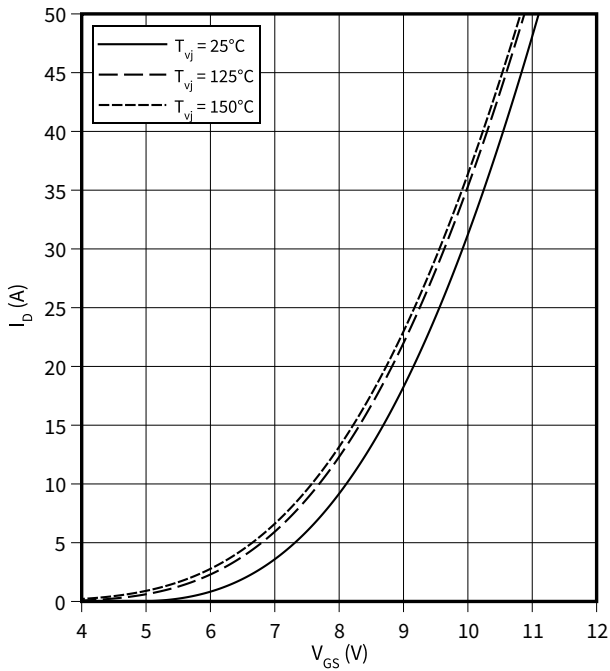

capacity characteristic (typical), MOSFET

$$C = f(V_{DS})$$

$$f = 1 \text{ MHz}, T_{vj} = 25^\circ\text{C}, V_{GS} = 0 \text{ V}$$

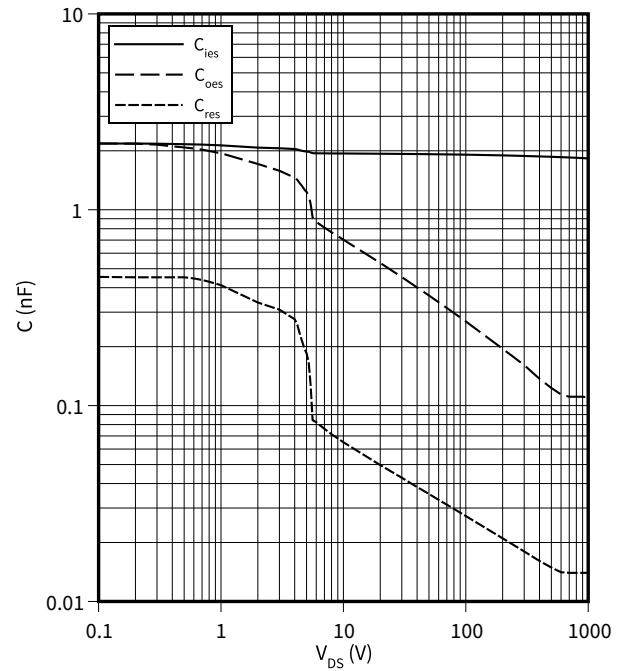

5 Characteristics diagrams

switching losses (typical), MOSFET

$E = f(I_D)$

$R_{Goff} = 3.9 \Omega$, $R_{Gon} = 7.5 \Omega$, $V_{DS} = 600 \text{ V}$, $V_{GS} = -5.0/15.0 \text{ V}$

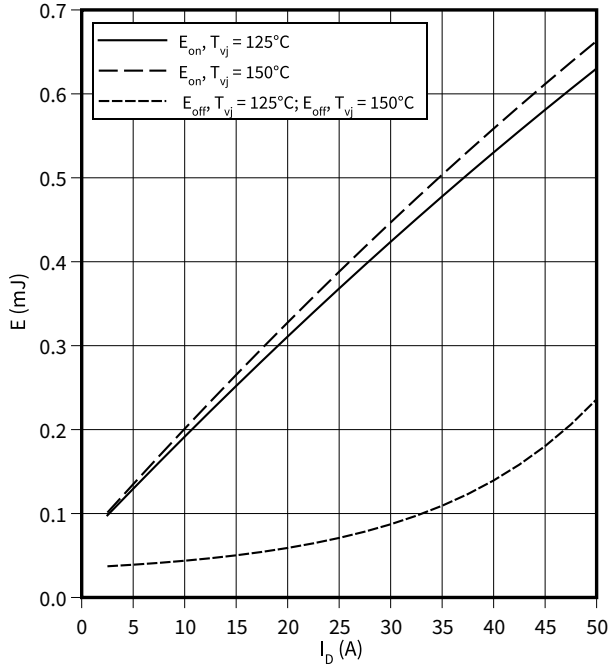

switching losses (typical), MOSFET

$E = f(R_G)$

$V_{DS} = 600 \text{ V}$, $I_D = 25 \text{ A}$, $V_{GS} = -5.0/15.0 \text{ V}$

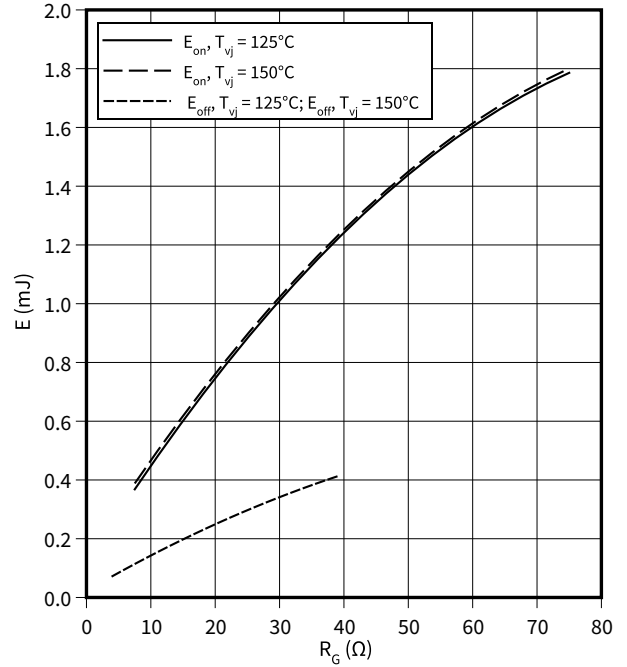

reverse bias safe operating area (RBSOA), MOSFET

$I_D = f(V_{DS})$

$R_{Goff} = 3.9 \Omega$, $T_{vj} = 150 \text{ °C}$, $V_{GS} = -5/15 \text{ V}$

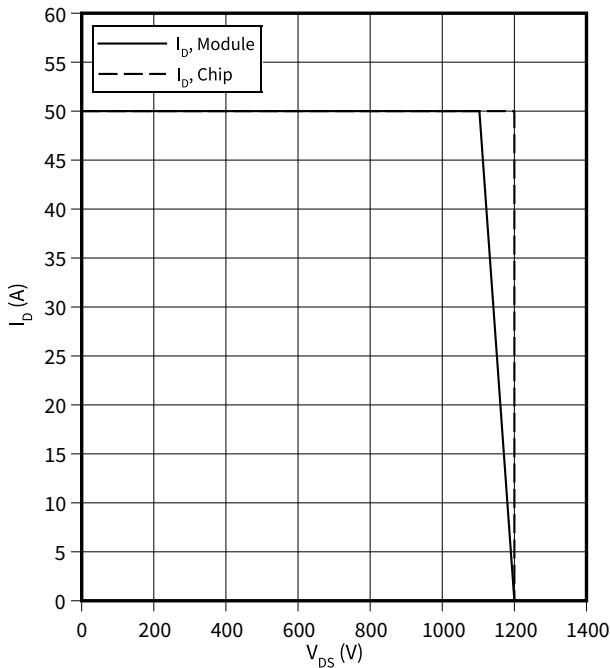

transient thermal impedance, MOSFET

$Z_{th} = f(t)$

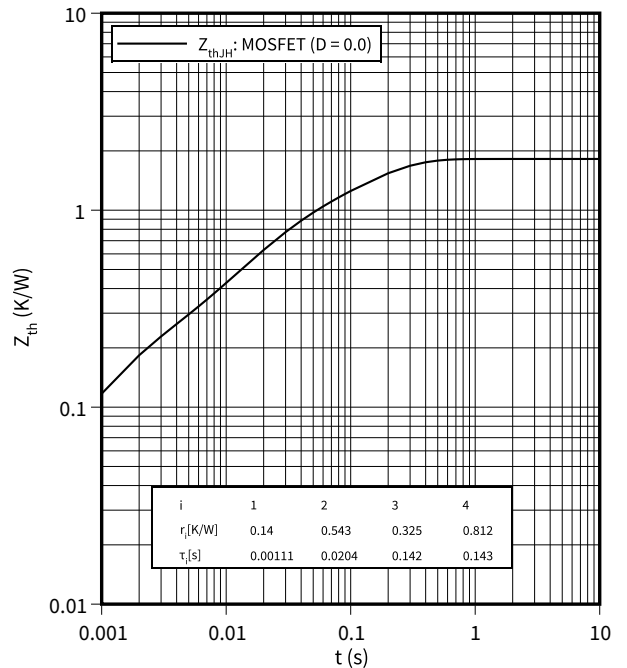

temperature characteristic (typical), NTC-Thermistor

$$R = f(T_{NTC})$$

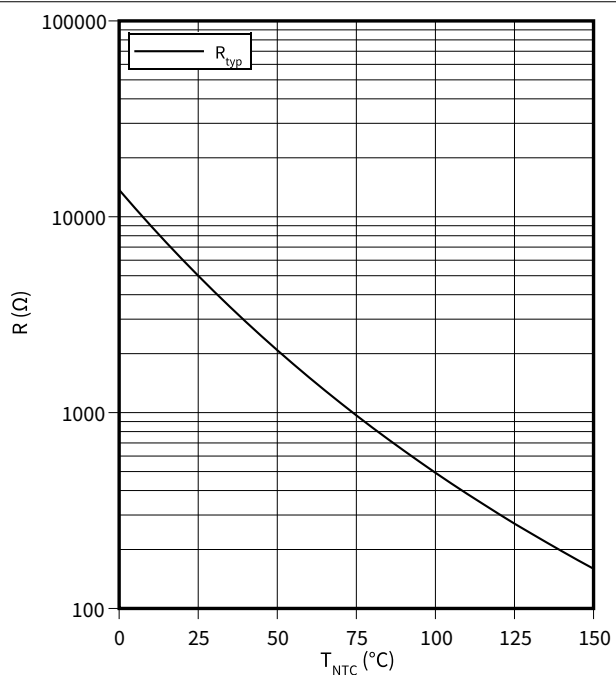

6 Circuit diagram

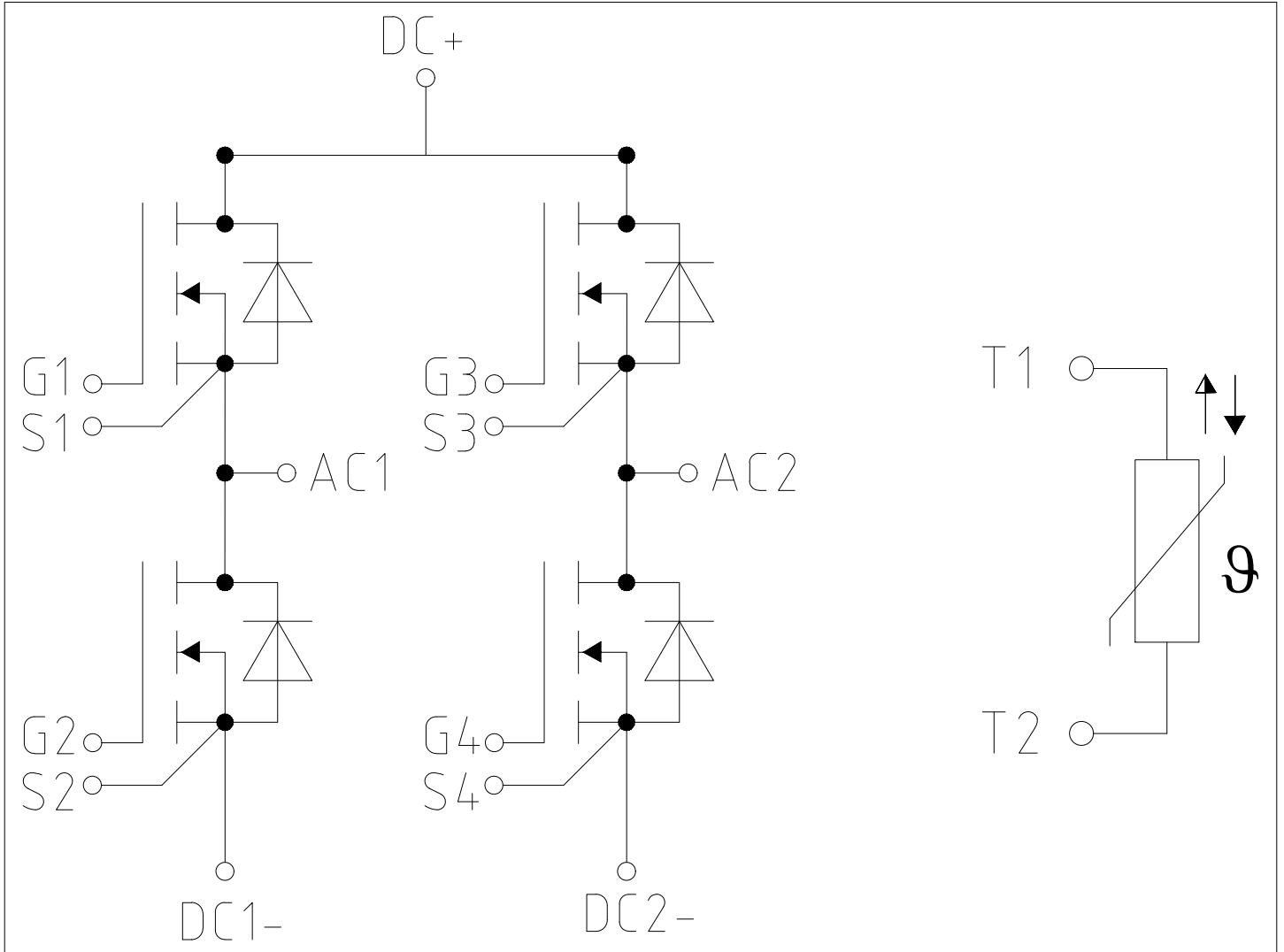

Figure 2

7 Package outlines

7 Package outlines

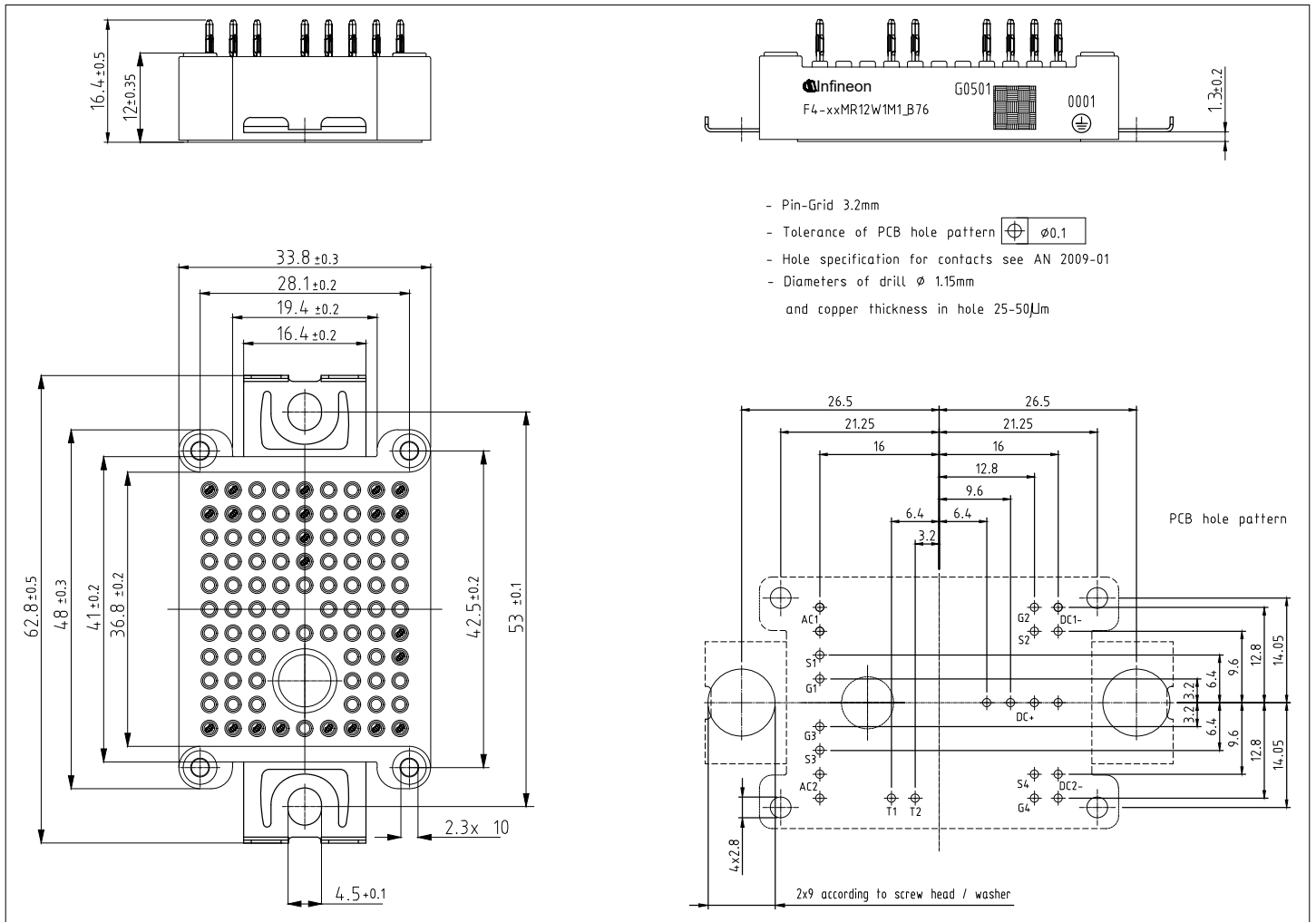

Figure 3

8 Module label code



Module label code			
Code format	Data Matrix	Barcode Code128	
Encoding	ASCII text	Code Set A	
Symbol size	16x16	23 digits	
Standard	IEC24720 and IEC16022	IEC8859-1	
Code content	<i>Content</i>	<i>Digit</i>	<i>Example</i>
	Module serial number	1 - 5	71549
	Module material number	6 - 11	142846
	Production order number	12 - 19	55054991
	Date code (production year)	20 - 21	15
	Date code (production week)	22 - 23	30
Example	 		
	71549142846550549911530		71549142846550549911530

Figure 4

Trademarks

All referenced product or service names and trademarks are the property of their respective owners.

Edition 2021-02-12

Published by

Infineon Technologies AG

81726 Munich, Germany

© 2021 Infineon Technologies AG

All Rights Reserved.

Do you have a question about any aspect of this document?

Email: erratum@infineon.com

Document reference

IFX-

IMPORTANT NOTICE

The information given in this document shall in no event be regarded as a guarantee of conditions or characteristics ("Beschaffheitsgarantie").

With respect to any examples, hints or any typical values stated herein and/or any information regarding the application of the product, Infineon Technologies hereby disclaims any and all warranties and liabilities of any kind, including without limitation warranties of non-infringement of intellectual property rights of any third party.

In addition, any information given in this document is subject to customer's compliance with its obligations stated in this document and any applicable legal requirements, norms and standards concerning customer's products and any use of the product of Infineon Technologies in customer's applications.

The data contained in this document is exclusively intended for technically trained staff. It is the responsibility of customer's technical departments to evaluate the suitability of the product for the intended application and the completeness of the product information given in this document with respect to such application.

Please note that this product is not qualified according to the AEC Q100 or AEC Q101 documents of the Automotive Electronics Council.

WARNINGS

Due to technical requirements products may contain dangerous substances. For information on the types in question please contact your nearest Infineon Technologies office.

Except as otherwise explicitly approved by Infineon Technologies in a written document signed by authorized representatives of Infineon Technologies, Infineon Technologies' products may not be used in any applications where a failure of the product or any consequences of the use thereof can reasonably be expected to result in personal injury.