

## Automotive MOSFET

## OptiMOS™-5 Power-Transistor



## Features

- OptiMOS™ power MOSFET for automotive applications
- N-channel – Enhancement mode – Normal Level
- Extended qualification beyond AEC-Q101
- Enhanced electrical testing
- Robust design
- MSL3 up to 260°C peak reflow
- 175°C operating temperature
- Green product (RoHS compliant)
- 100% Avalanche tested

## Potential applications

General automotive applications.

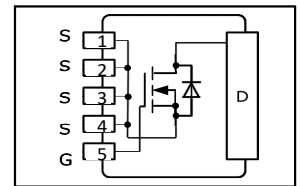
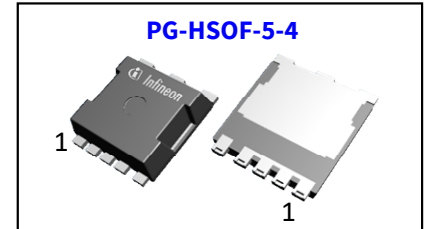

## Product Summary

$V_{DS}$	100	V
$R_{DS(on)}$	2.4	mΩ
$I_D$ (chip limited)	210	A

Type	Package	Marking
IAUA210N10S5N024	PG-HSOF-5-4	5N10024



**Table of Contents**

Description ..... 1

Maximum ratings ..... 3

Thermal characteristics ..... 4

Electrical characteristics ..... 4

Electrical characteristics diagrams ..... 6

Package outline & footprint ..... 10

Revision history ..... 11

Disclaimer ..... 12

## Maximum ratings

at  $T_j=25\text{ °C}$ , unless otherwise specified

Parameter	Symbol	Conditions	Value	Unit
Continuous drain current	$I_D$	$V_{GS}=10\text{ V}$ , Chip limitation <sup>1)</sup>	210	A
		$V_{GS}=10\text{ V}$ , DC current <sup>2)</sup>	210	
		$T_a=85\text{ °C}$ , $V_{GS}=10\text{ V}$ , $R_{thJA}$ on 2s2p <sup>2,3)</sup>	26	
Pulsed drain current <sup>2)</sup>	$I_{D,pulse}$	$T_C=25\text{ °C}$ , $t_p=100\text{ }\mu\text{s}$	674	
Avalanche energy, single pulse <sup>2)</sup>	$E_{AS}$	$I_D=105\text{ A}$	245	mJ
Avalanche current, single pulse	$I_{AS}$	-	170	A
Gate source voltage	$V_{GS}$	-	$\pm 20$	V
Power dissipation	$P_{tot}$	$T_C=25\text{ °C}$	238	W
Operating and storage temperature	$T_j, T_{stg}$	-	-55 ... +175	°C
IEC climatic category; DIN IEC 68-1	-	-	55/175/56	

## Thermal characteristics<sup>2)</sup>

Parameter	Symbol	Conditions	Values			Unit
			min.	typ.	max.	
Thermal resistance, junction - case	$R_{thJC}$	-	-	-	0.63	K/W
Thermal resistance, junction - ambient <sup>3)</sup>	$R_{thJA}$	-	-	22.7	-	

## Electrical characteristics

at  $T_j=25\text{ °C}$ , unless otherwise specified

Parameter	Symbol	Conditions	Values			Unit
			min.	typ.	max.	

### Static characteristics

Drain-source breakdown voltage	$V_{(BR)DSS}$	$V_{GS}=0\text{ V}, I_D=1\text{ mA}$	100	-	-	V
Gate threshold voltage	$V_{GS(th)}$	$V_{DS}=V_{GS}, I_D=150\text{ }\mu\text{A}$	2.2	3	3.8	
Zero gate voltage drain current	$I_{DSS}$	$V_{DS}=100\text{ V}, V_{GS}=0\text{ V}, T_j=25\text{ °C}$	-	0.1	1	$\mu\text{A}$
		$V_{DS}=100\text{ V}, V_{GS}=0\text{ V}, T_j=100\text{ °C}^{2)}$	-	1	100	
Gate-source leakage current	$I_{GSS}$	$V_{GS}=20\text{ V}, V_{DS}=0\text{ V}$	-	-	100	nA
Drain-source on-state resistance	$R_{DS(on)}$	$V_{GS}=6\text{ V}, I_D=50\text{ A}$	-	2.5	3.0	m $\Omega$
		$V_{GS}=10\text{ V}, I_D=100\text{ A}$	-	2.0	2.4	
Gate resistance <sup>2)</sup>	$R_G$	-	-	1.4	-	$\Omega$

Parameter	Symbol	Conditions	Values			Unit
			min.	typ.	max.	

**Dynamic characteristics<sup>2)</sup>**

Input capacitance	$C_{iss}$	$V_{GS}=0\text{ V}, V_{DS}=50\text{ V}, f=1\text{ MHz}$	-	6689	8696	pF
Output capacitance	$C_{oss}$		-	1073	1395	
Reverse transfer capacitance	$C_{rss}$		-	41	62	
Turn-on delay time	$t_{d(on)}$	$V_{DD}=50\text{ V}, V_{GS}=10\text{ V},$ $I_D=100\text{ A}, R_G=3.5\ \Omega$	-	16	-	ns
Rise time	$t_r$		-	8	-	
Turn-off delay time	$t_{d(off)}$		-	32	-	
Fall time	$t_f$		-	19	-	

**Gate Charge Characteristics<sup>2)</sup>**

Gate to source charge	$Q_{gs}$	$V_{DD}=50\text{ V}, I_D=100\text{ A},$ $V_{GS}=0\text{ to }10\text{ V}$	-	31	41	nC
Gate to drain charge	$Q_{gd}$		-	18	27	
Gate charge total	$Q_g$		-	91	119	
Gate plateau voltage	$V_{plateau}$		-	4.7	-	V

**Reverse Diode**

Diode continuous forward current <sup>2)</sup>	$I_S$	$T_C=25\text{ °C}$	-	-	210	A
Diode pulse current <sup>2)</sup>	$I_{S,pulse}$	$T_C=25\text{ °C}, t_p=100\ \mu\text{s}$	-	-	674	
Diode forward voltage	$V_{SD}$	$V_{GS}=0\text{ V}, I_F=100\text{ A},$ $T_j=25\text{ °C}$	-	0.9	1.2	V
Reverse recovery time <sup>2)</sup>	$t_{rr}$	$V_R=50\text{ V}, I_F=50\text{ A},$ $di_f/dt=100\text{ A}/\mu\text{s}$	-	63	-	ns
Reverse recovery charge <sup>2)</sup>	$Q_{rr}$		-	104	-	nC

<sup>1)</sup> Practically the current is limited by the overall system design including the customer-specific PCB.

<sup>2)</sup> The parameter is not subject to production testing – specified by design.

<sup>3)</sup> Device on 2s2p FR4 PCB defined in accordance with JEDEC standards (JESD51-5, -7). PCB is vertical in still air.

### Electrical characteristics diagrams

#### 1 Power dissipation

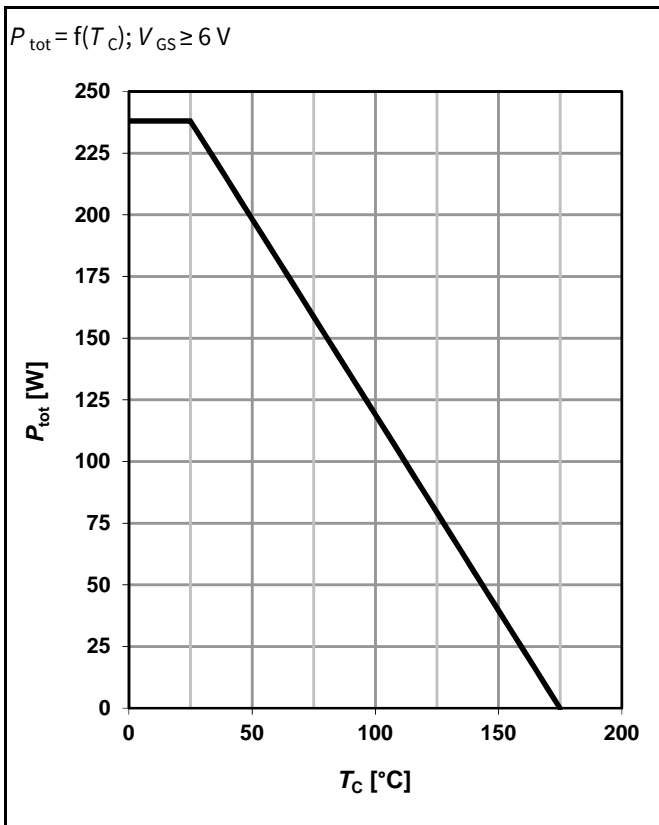

#### 2 Drain current

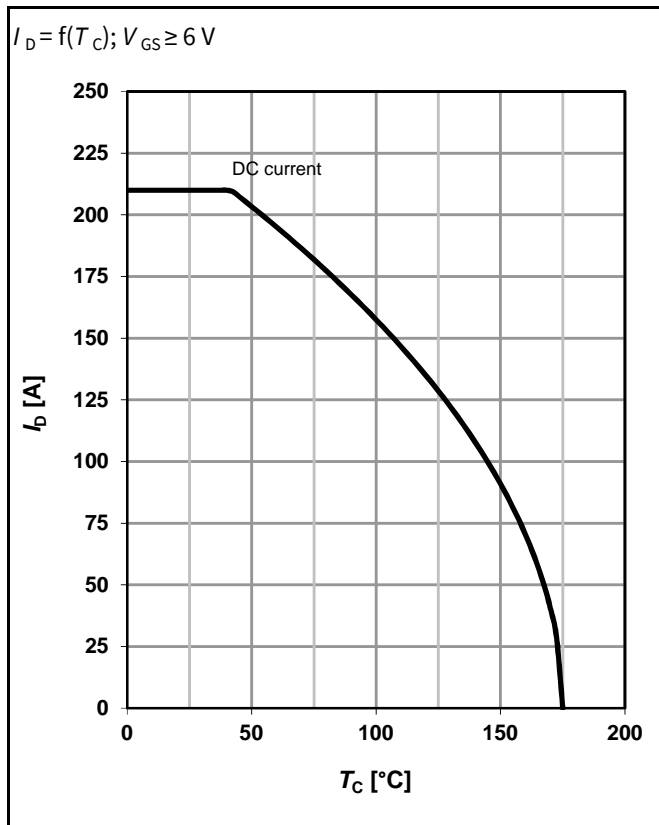

#### 3 Safe operating area

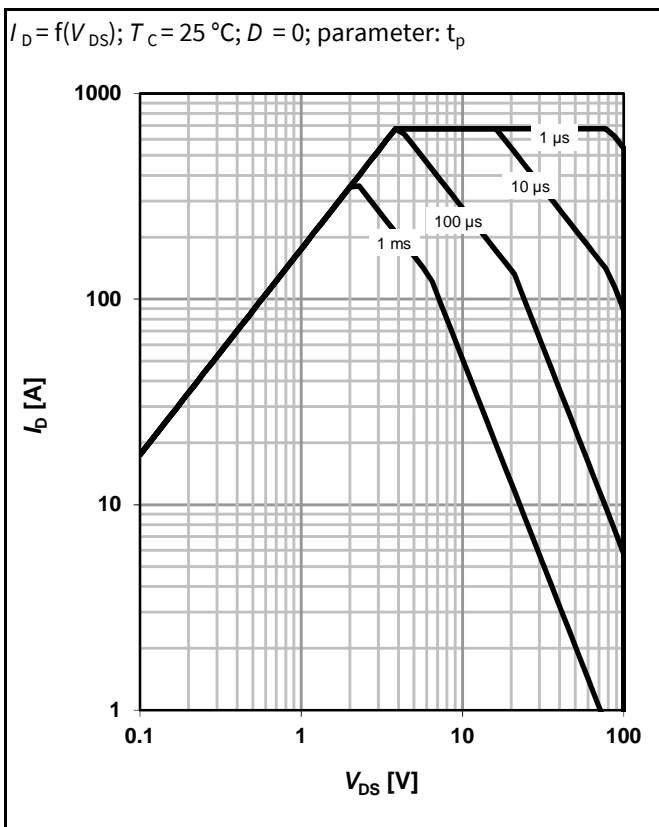

#### 4 Max. transient thermal impedance

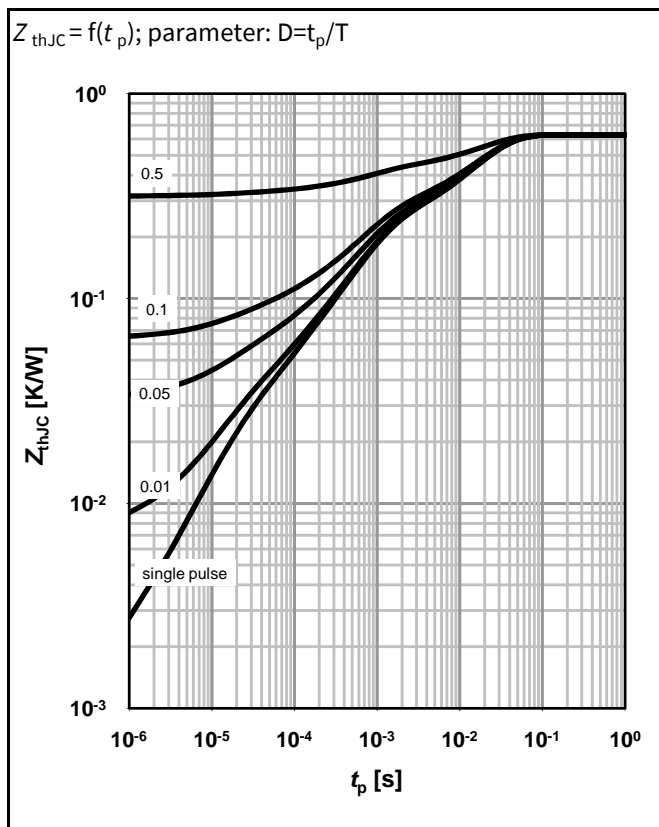

5 Typ. output characteristics

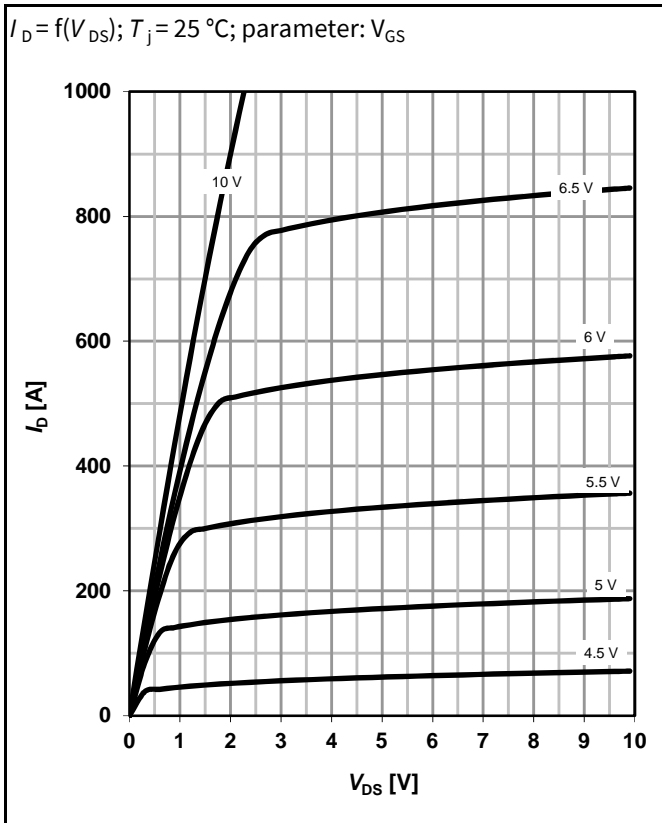

6 Typ. drain-source on-state resistance

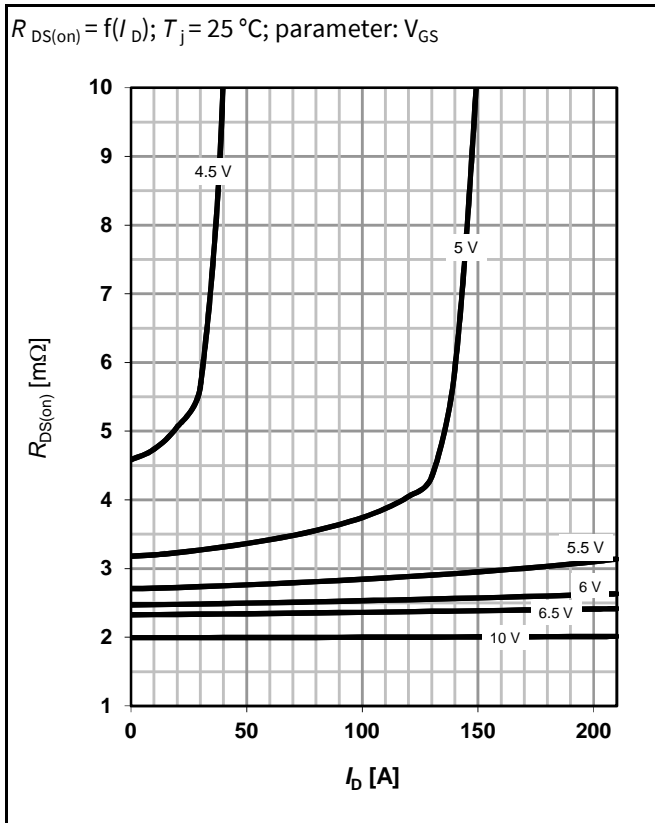

7 Typ. transfer characteristics

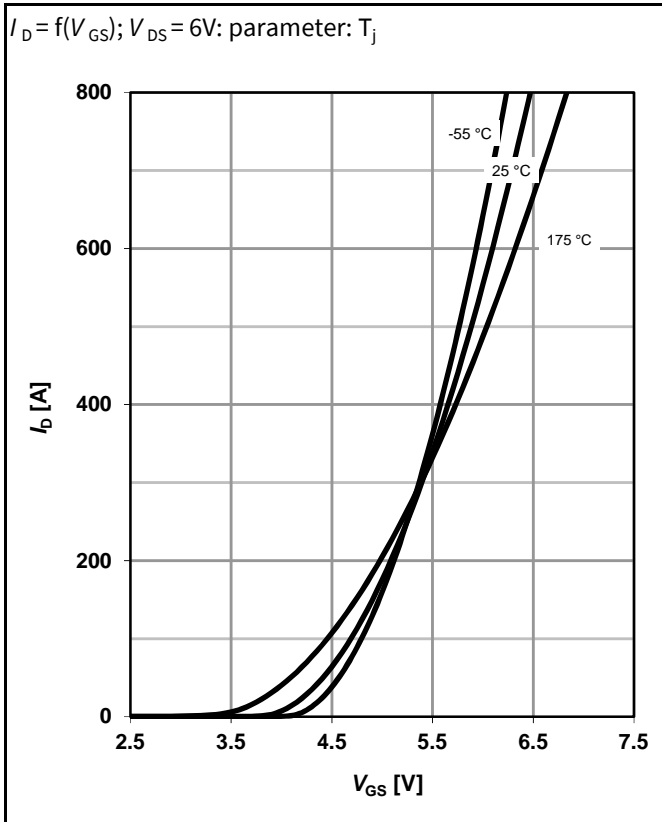

8 Typ. drain-source on-state resistance

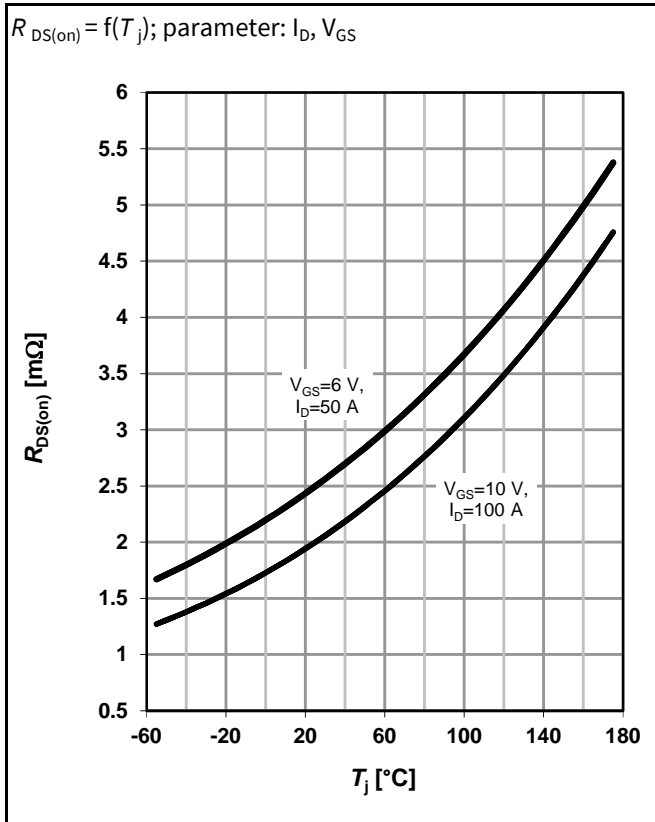

9 Typ. gate threshold voltage

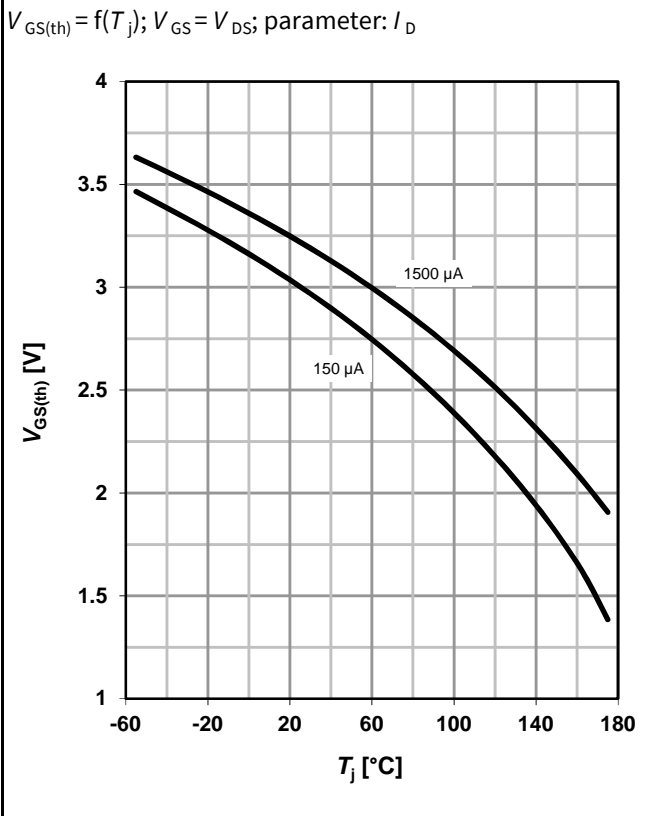

10 Typ. capacitances

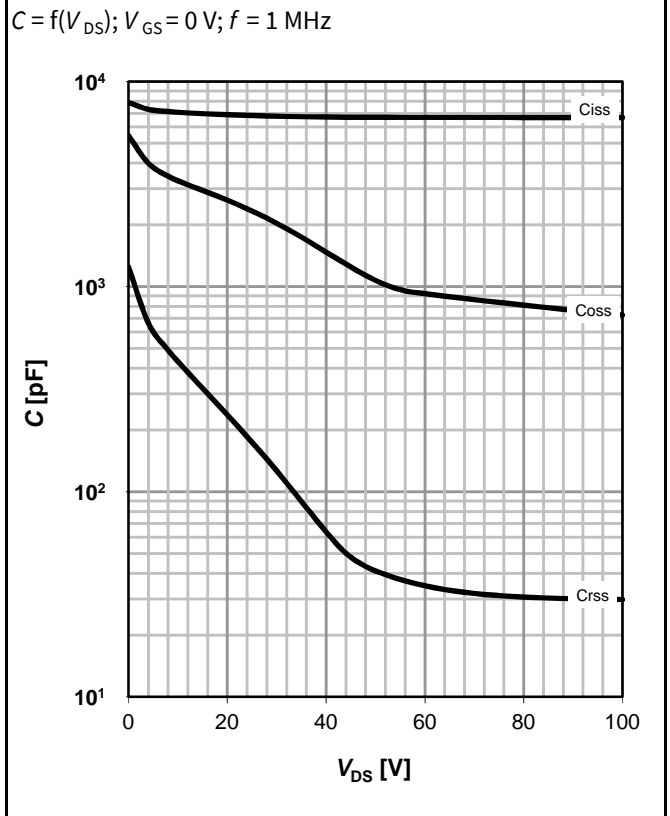

11 Typical forward diode characteristics

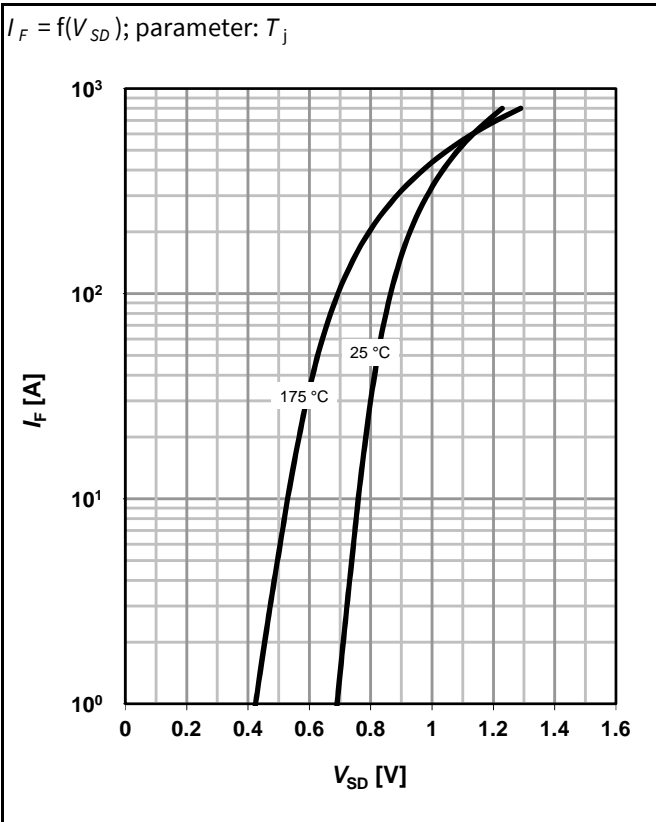

12 Typ. avalanche characteristics

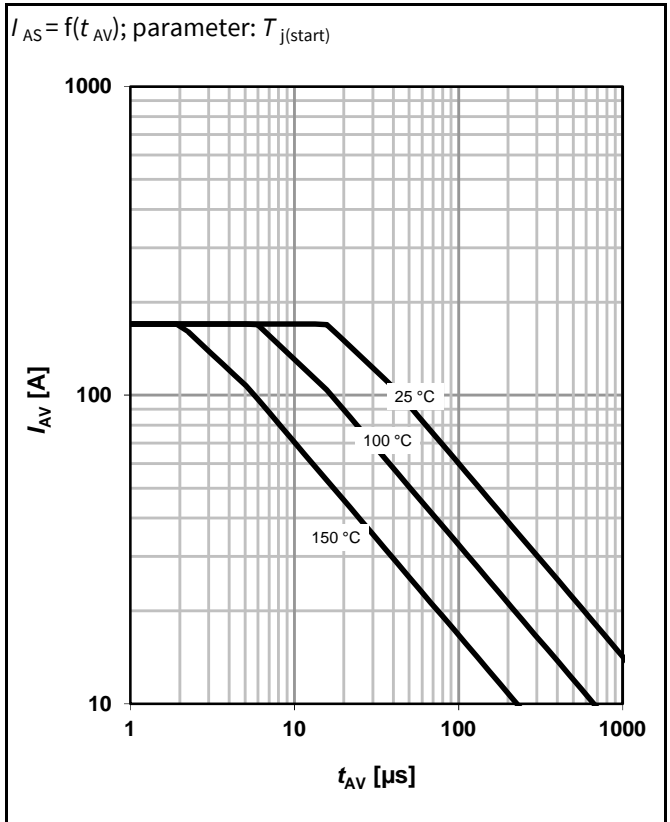



13 Typical avalanche energy

$E_{AS} = f(T_j)$ ; parameter: ID

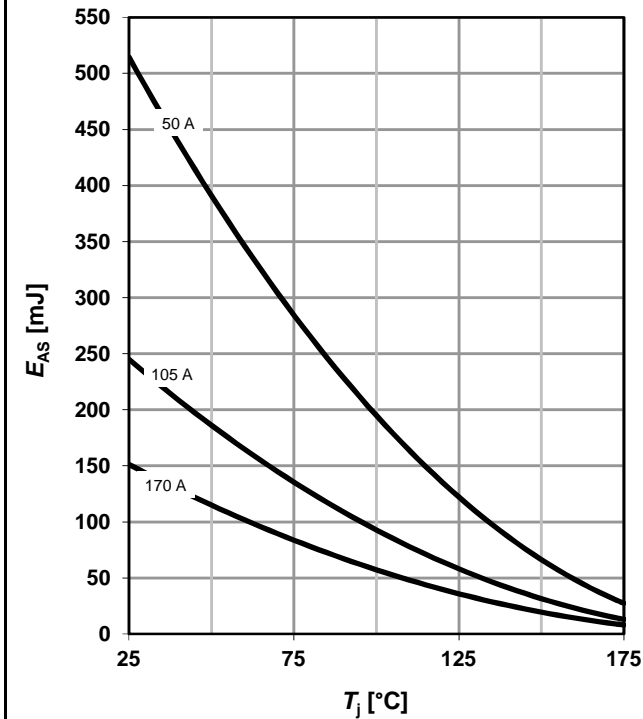

14 Drain-source breakdown voltage

$V_{BR(DSS)} = f(T_j)$ ;  $I_{D\_typ} = 1$  mA

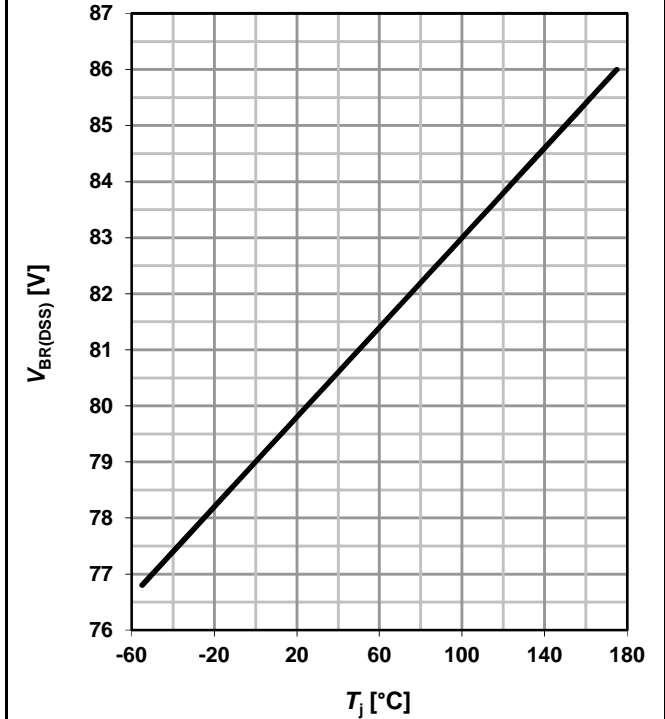

15 Typ. gate charge

$V_{GS} = f(Q_{gate})$ ;  $I_D = 100$  A pulsed; parameter:  $V_{DD}$

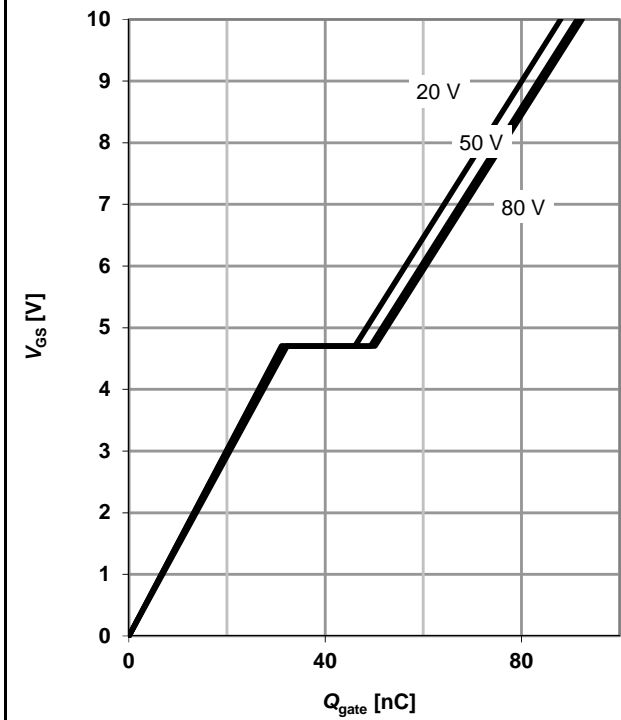

16 Gate charge waveforms

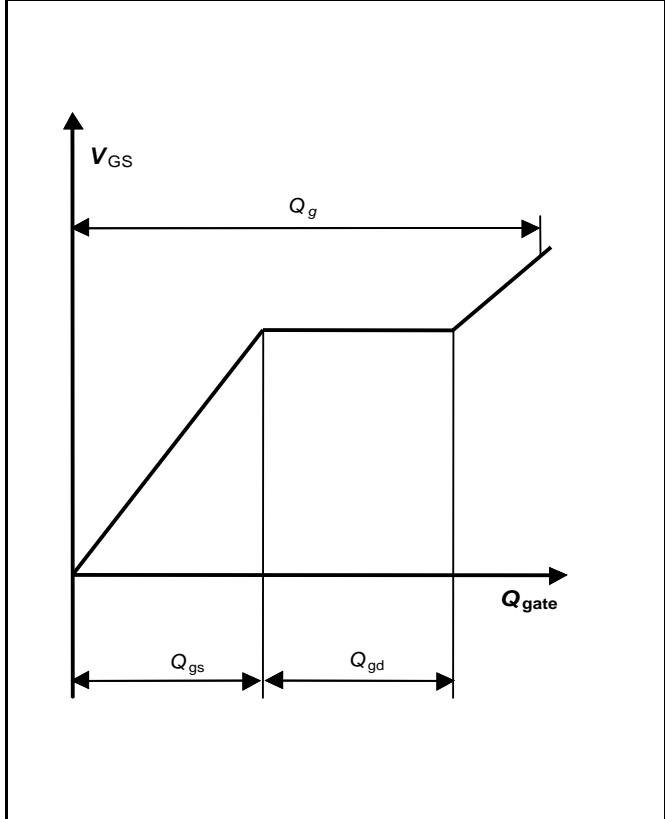

## Package Outline

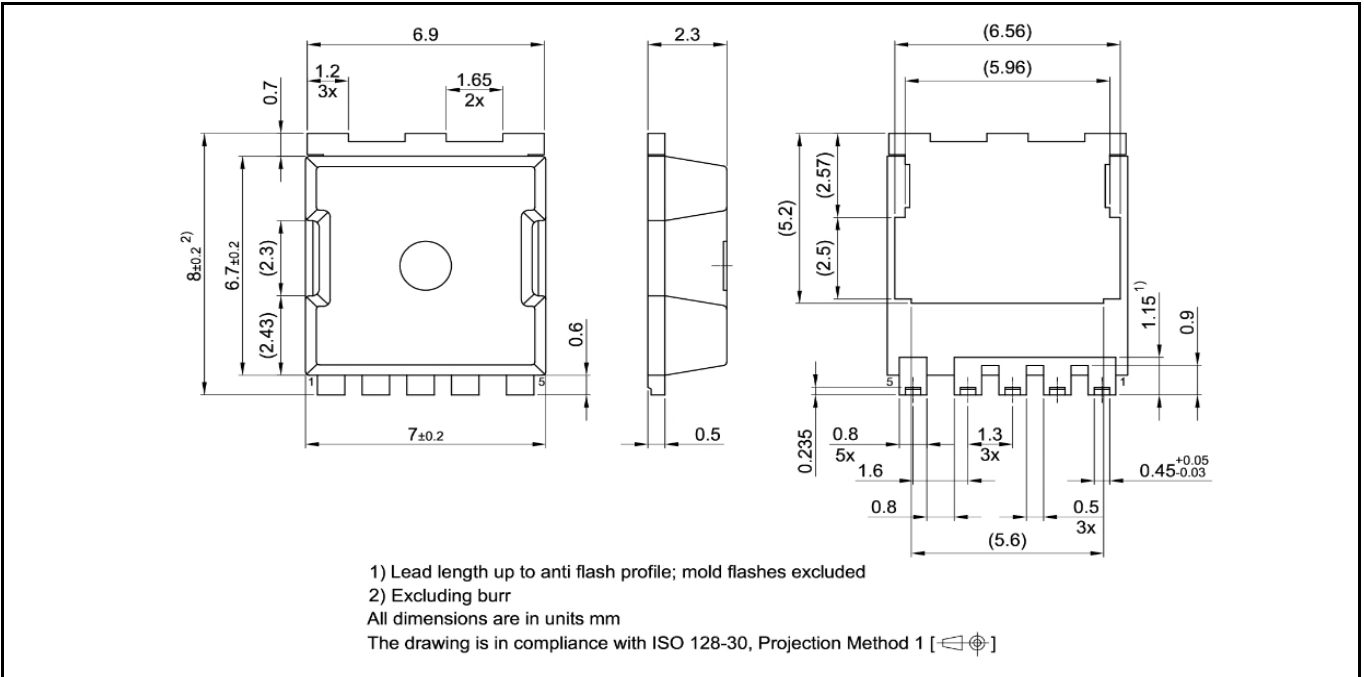

## Footprint

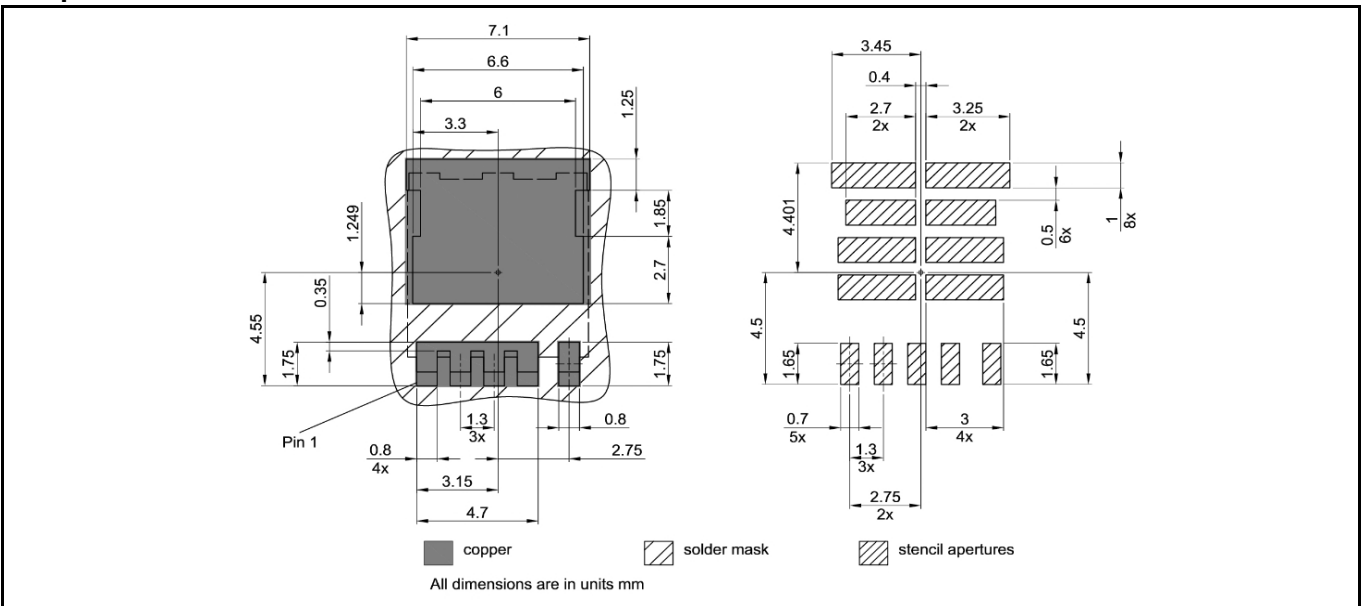

## Packaging

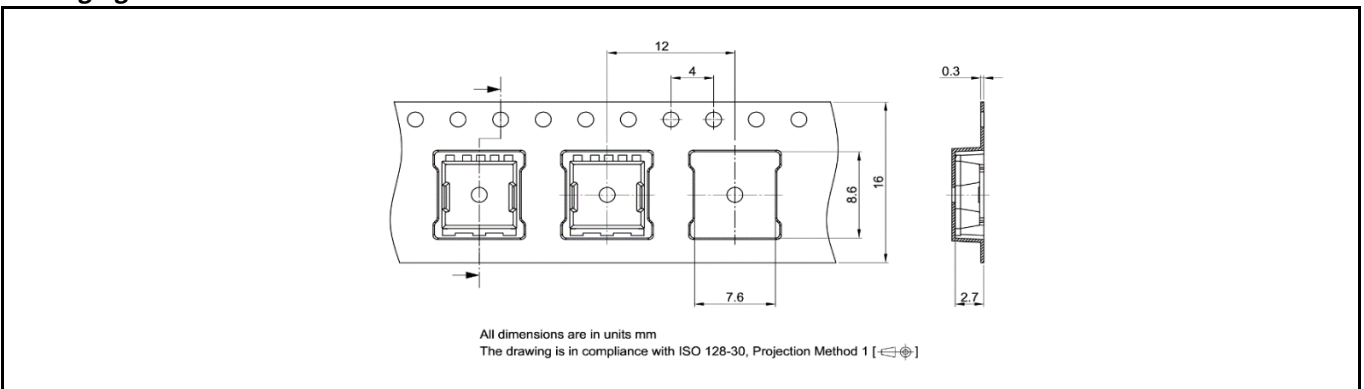

## Revision History

Revision	Date	Changes
Revision 1.0	17.03.2021	Final Datasheet

**Trademarks**

All referenced product or service names and trademarks are the property of their respective owners.

**Edition 2021-03-17****Published by****Infineon Technologies AG****81726 Munich, Germany****© 2021 Infineon Technologies AG****All Rights Reserved.****Do you have any questions about any aspect of this document?****Email: [erratum@infineon.com](mailto:erratum@infineon.com)****IMPORTANT NOTICE**

The information given in this document shall in no event be regarded as a guarantee of conditions or characteristics ("Beschaffenheitsgarantie").

With respect to any examples, hints or any typical values stated herein and/or any information regarding the application of the product, Infineon Technologies hereby disclaims any and all warranties and liabilities of any kind, including without limitation warranties of non-infringement of intellectual property rights of any third party.

In addition, any information given in this document is subject to customer's compliance with its obligations stated in this document and any applicable legal requirements, norms and standards concerning customer's products and any use of the product of Infineon Technologies in customer's applications. The data contained in this document is exclusively intended for technically trained staff. It is the responsibility of customer's technical departments to evaluate the suitability of the product for the intended application and the completeness of the product information given in this document with respect to such application.

For further information on technology, delivery terms and conditions and prices, please contact the nearest Infineon Technologies Office ([www.infineon.com](http://www.infineon.com)).

**WARNINGS**

Due to technical requirements products may contain dangerous substances. For information on the types in question please contact the nearest Infineon Technologies Office.

Except as otherwise explicitly approved by Infineon Technologies in a written document signed by authorized representatives of Infineon Technologies, Infineon Technologies' products may not be used in any applications where a failure of the product or any consequences of the use thereof can reasonably be expected to result in personal injury.