

Sixth generation, high speed soft switching series

High speed soft switching TRENCHSTOP™ IGBT 6 in Trench and Fieldstop technology copacked with soft and fast recovery anti-parallel diode

**Features:**

- 1200V TRENCHSTOP™ IGBT6 technology offering:
- High efficiency in hard switching and resonant topologies
  - Easy paralleling capability due to positive temperature coefficient in  $V_{CEsat}$
  - Low EMI
  - Low Gate Charge  $Q_g$
  - Very soft, fast recovery full current anti-parallel diode
  - Maximum junction temperature 175°C
  - Pb-free lead plating; RoHS compliant
  - Complete product spectrum and PSpice Models:  
<http://www.infineon.com/igbt/>

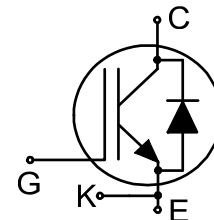

**Applications:**

- Industrial UPS
- Charger
- Energy storage
- Three-level Solar String Inverter
- Welding

**Product Validation:**

Qualified for industrial applications according to the relevant tests of JEDEC47/20/22



**Key Performance and Package Parameters**

Type	$V_{CE}$	$I_C$	$V_{CEsat}, T_{vj}=25^{\circ}C$	$T_{vjmax}$	Marking	Package
IKY40N120CS6	1200V	40A	1.85V	175°C	K40MCS6	PG-TO247-4-2

---

Sixth generation, high speed soft switching series

## Table of Contents

Description .....	1
Table of Contents .....	2
Maximum Ratings .....	3
Thermal Resistance .....	3
Electrical Characteristics .....	4
Electrical Characteristics Diagrams .....	6
Package Drawing .....	13
Testing Conditions .....	14
Revision History .....	15
Disclaimer .....	16

## Sixth generation, high speed soft switching series

**Maximum Ratings**

For optimum lifetime and reliability, Infineon recommends operating conditions that do not exceed 80% of the maximum ratings stated in this datasheet.

Parameter	Symbol	Value	Unit
Collector-emitter voltage, $T_{vj} \geq 25^{\circ}\text{C}$	$V_{CE}$	1200	V
DC collector current, limited by $T_{vjmax}$ $T_c = 25^{\circ}\text{C}$ $T_c = 100^{\circ}\text{C}$	$I_C$	80.0 40.0	A
Pulsed collector current, $t_p$ limited by $T_{vjmax}$	$I_{Cpuls}$	160.0	A
Turn off safe operating area $V_{CE} \leq 1200\text{V}$ , $T_{vj} \leq 175^{\circ}\text{C}$	-	160.0	A
Diode forward current, limited by $T_{vjmax}$ $T_c = 25^{\circ}\text{C}$ $T_c = 100^{\circ}\text{C}$	$I_F$	80.0 40.0	A
Diode pulsed current, $t_p$ limited by $T_{vjmax}$	$I_{Fpuls}$	160.0	A
Gate-emitter voltage Transient Gate-emitter voltage ( $t_p \leq 0.5\mu\text{s}$ , $D < 0.001$ )	$V_{GE}$	$\pm 20$ 25	V
Power dissipation $T_c = 25^{\circ}\text{C}$ Power dissipation $T_c = 100^{\circ}\text{C}$	$P_{tot}$	500.0 250.0	W
Operating junction temperature	$T_{vj}$	-40...+175	$^{\circ}\text{C}$
Storage temperature	$T_{stg}$	-55...+150	$^{\circ}\text{C}$
Soldering temperature, wave soldering 1.6mm (0.063in.) from case for 10s		260	$^{\circ}\text{C}$

**Thermal Resistance**

Parameter	Symbol	Conditions	Value			Unit
			min.	typ.	max.	
<b><math>R_{th}</math> Characteristics</b>						
IGBT thermal resistance, junction - case	$R_{th(j-c)}$		-	-	0.30	K/W
Diode thermal resistance, junction - case	$R_{th(j-c)}$		-	-	0.78	K/W
Thermal resistance junction - ambient	$R_{th(j-a)}$		-	-	40	K/W

Sixth generation, high speed soft switching series

**Electrical Characteristic, at  $T_{vj} = 25^{\circ}\text{C}$ , unless otherwise specified**

Parameter	Symbol	Conditions	Value			Unit
			min.	typ.	max.	
<b>Static Characteristic</b>						
Collector-emitter saturation voltage	$V_{CEsat}$	$V_{GE} = 15.0\text{V}$ , $I_C = 40.0\text{A}$ $T_{vj} = 25^{\circ}\text{C}$ $T_{vj} = 125^{\circ}\text{C}$ $T_{vj} = 175^{\circ}\text{C}$	- - -	1.85 2.15 2.25	2.15 - -	V
Diode forward voltage	$V_F$	$V_{GE} = 0\text{V}$ , $I_F = 40.0\text{A}$ $T_{vj} = 25^{\circ}\text{C}$ $T_{vj} = 175^{\circ}\text{C}$	- -	2.20 2.25	2.55 -	V
Gate-emitter threshold voltage	$V_{GE(th)}$	$I_C = 1.90\text{mA}$ , $V_{CE} = V_{GE}$	5.1	5.7	6.3	V
Zero gate voltage collector current	$I_{CES}$	$V_{CE} = 1200\text{V}$ , $V_{GE} = 0\text{V}$ $T_{vj} = 25^{\circ}\text{C}$ $T_{vj} = 175^{\circ}\text{C}$	- -	- 1600	850 -	$\mu\text{A}$
Gate-emitter leakage current	$I_{GES}$	$V_{CE} = 0\text{V}$ , $V_{GE} = 20\text{V}$	-	-	600	nA
Transconductance	$g_{fs}$	$V_{CE} = 20\text{V}$ , $I_C = 40.0\text{A}$	-	32.0	-	S

**Electrical Characteristic, at  $T_{vj} = 25^{\circ}\text{C}$ , unless otherwise specified**

Parameter	Symbol	Conditions	Value			Unit
			min.	typ.	max.	
<b>Dynamic Characteristic</b>						
Input capacitance	$C_{ies}$	$V_{CE} = 25\text{V}$ , $V_{GE} = 0\text{V}$ , $f = 1\text{MHz}$	-	2700	-	pF
Output capacitance	$C_{oes}$		-	185	-	
Reverse transfer capacitance	$C_{res}$		-	120	-	
Gate charge	$Q_G$	$V_{CC} = 960\text{V}$ , $I_C = 40.0\text{A}$ , $V_{GE} = 15\text{V}$	-	285.0	-	nC
Internal emitter inductance measured 5mm (0.197 in.) from case	$L_E$		-	13.0	-	nH

**Switching Characteristic, Inductive Load**

Parameter	Symbol	Conditions	Value			Unit
			min.	typ.	max.	

**IGBT Characteristic, at  $T_{vj} = 25^{\circ}\text{C}$** 

Turn-on delay time	$t_{d(on)}$	$T_{vj} = 25^{\circ}\text{C}$ , $V_{CC} = 600\text{V}$ , $I_C = 40.0\text{A}$ , $V_{GE} = 0.0/15.0\text{V}$ , $R_{G(on)} = 9.0\Omega$ , $R_{G(off)} = 9.0\Omega$ , $L\sigma = 70\text{nH}$ , $C\sigma = 67\text{pF}$ $L\sigma$ , $C\sigma$ from Fig. E Energy losses include "tail" and diode reverse recovery.	-	27	-	ns
Rise time	$t_r$		-	27	-	ns
Turn-off delay time	$t_{d(off)}$		-	315	-	ns
Fall time	$t_f$		-	27	-	ns
Turn-on energy	$E_{on}$		-	1.45	-	mJ
Turn-off energy	$E_{off}$		-	1.55	-	mJ
Total switching energy	$E_{ts}$		-	3.00	-	mJ

Sixth generation, high speed soft switching series

#### Diode Characteristic, at $T_{vj} = 25^{\circ}\text{C}$

Diode reverse recovery time	$t_{rr}$	$T_{vj} = 25^{\circ}\text{C}$ , $V_R = 600\text{V}$ , $I_F = 40.0\text{A}$ , $di_F/dt = 1650\text{A}/\mu\text{s}$ , $L\sigma = 70\text{nH}$ , $C\sigma = 67\text{pF}$	-	255	-	ns
Diode reverse recovery charge	$Q_{rr}$		-	2.60	-	$\mu\text{C}$
Diode peak reverse recovery current	$I_{rrm}$		-	39.0	-	A
Diode peak rate of fall of reverse recovery current during $t_b$	$di_{rr}/dt$		-	-450	-	$\text{A}/\mu\text{s}$

#### Switching Characteristic, Inductive Load

Parameter	Symbol	Conditions	Value			Unit
			min.	typ.	max.	

#### IGBT Characteristic, at $T_{vj} = 175^{\circ}\text{C}$

Turn-on delay time	$t_{d(on)}$	$T_{vj} = 175^{\circ}\text{C}$ , $V_{CC} = 600\text{V}$ , $I_C = 40.0\text{A}$ , $V_{GE} = 0.0/15.0\text{V}$ , $R_{G(on)} = 9.0\Omega$ , $R_{G(off)} = 9.0\Omega$ , $L\sigma = 70\text{nH}$ , $C\sigma = 67\text{pF}$ $L\sigma$ , $C\sigma$ from Fig. E Energy losses include "tail" and diode reverse recovery.	-	27	-	ns
Rise time	$t_r$		-	29	-	ns
Turn-off delay time	$t_{d(off)}$		-	390	-	ns
Fall time	$t_f$		-	55	-	ns
Turn-on energy	$E_{on}$		-	2.05	-	mJ
Turn-off energy	$E_{off}$		-	2.95	-	mJ
Total switching energy	$E_{ts}$		-	5.00	-	mJ

#### Diode Characteristic, at $T_{vj} = 175^{\circ}\text{C}$

Diode reverse recovery time	$t_{rr}$	$T_{vj} = 175^{\circ}\text{C}$ , $V_R = 600\text{V}$ , $I_F = 40.0\text{A}$ , $di_F/dt = 1650\text{A}/\mu\text{s}$ , $L\sigma = 70\text{nH}$ , $C\sigma = 67\text{pF}$	-	360	-	ns
Diode reverse recovery charge	$Q_{rr}$		-	5.30	-	$\mu\text{C}$
Diode peak reverse recovery current	$I_{rrm}$		-	53.0	-	A
Diode peak rate of fall of reverse recovery current during $t_b$	$di_{rr}/dt$		-	-580	-	$\text{A}/\mu\text{s}$

Sixth generation, high speed soft switching series

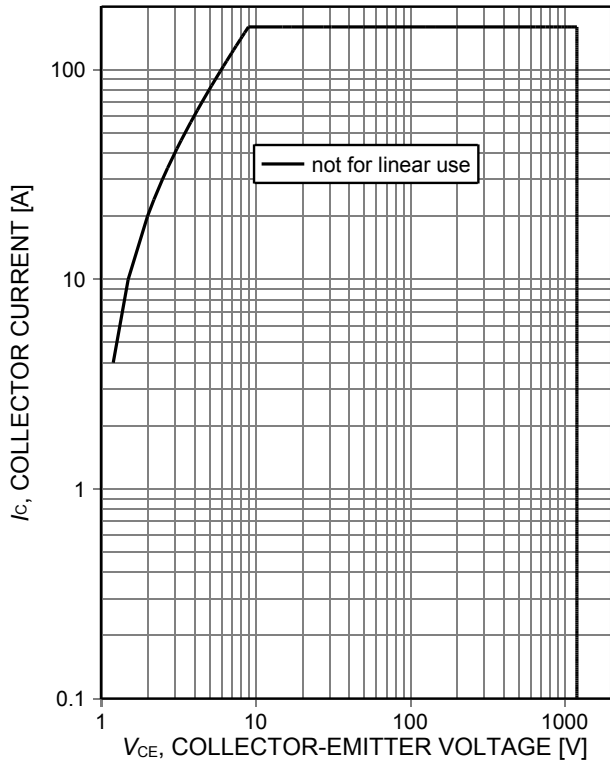

Figure 1. **Forward bias safe operating area**  
 ( $D=0$ ,  $T_{vj} \leq 175^{\circ}\text{C}$ ;  $V_{GE}=15\text{V}$ , pulse width limited by  $T_{vjmax}$ )

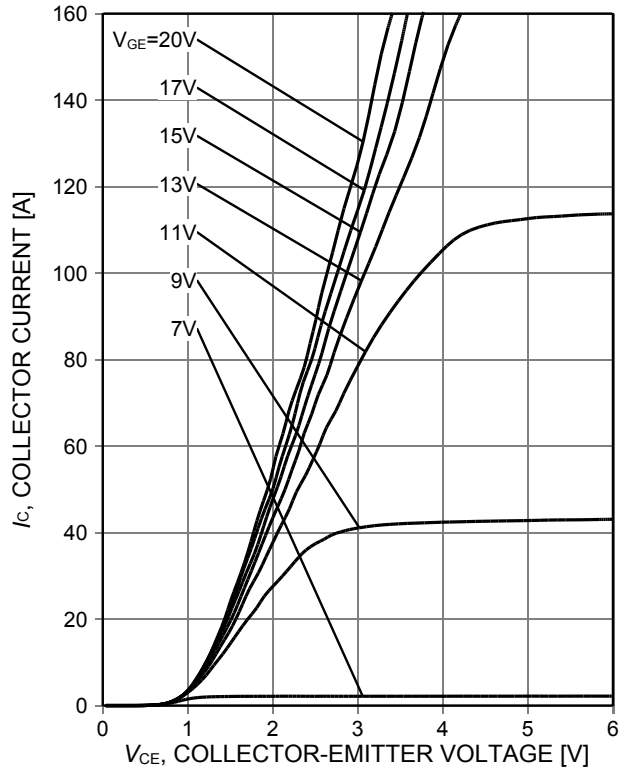

Figure 2. **Typical output characteristic**  
 ( $T_{vj}=25^{\circ}\text{C}$ )

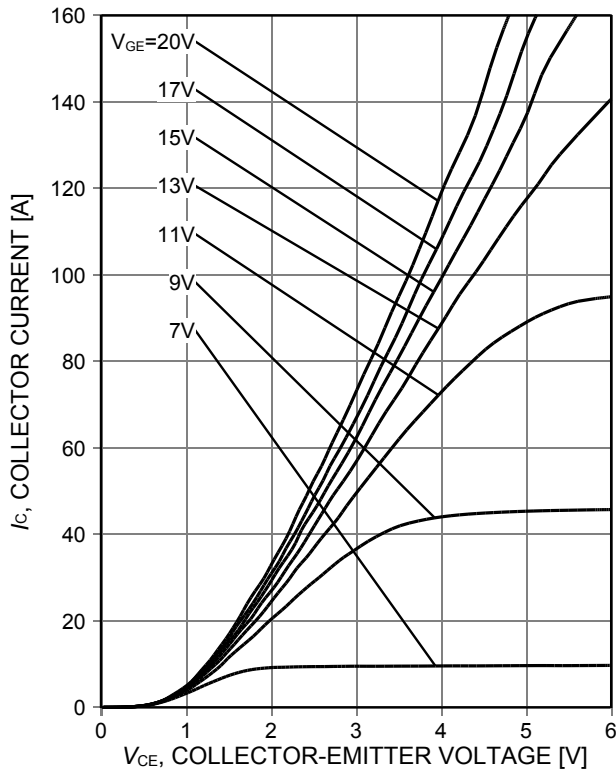

Figure 3. **Typical output characteristic**  
 ( $T_{vj}=175^{\circ}\text{C}$ )

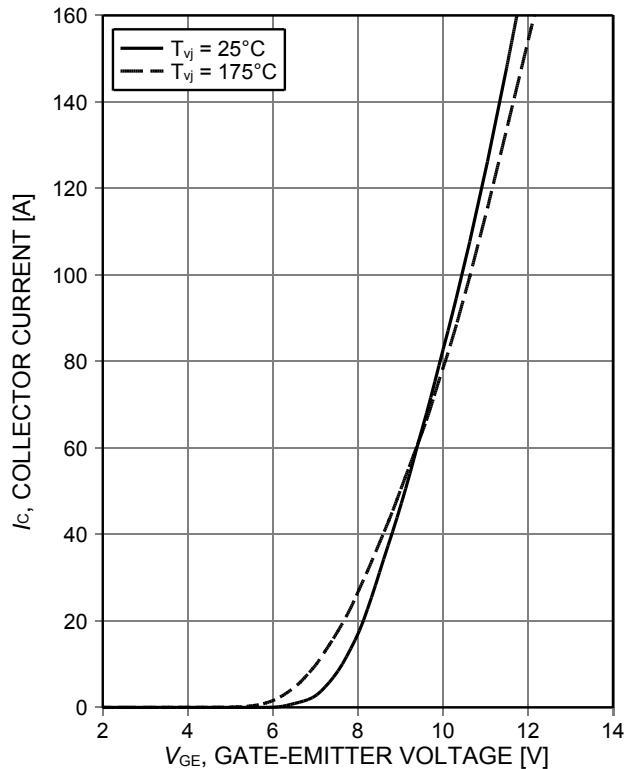

Figure 4. **Typical transfer characteristic**  
 ( $V_{CE}=20\text{V}$ )

Sixth generation, high speed soft switching series

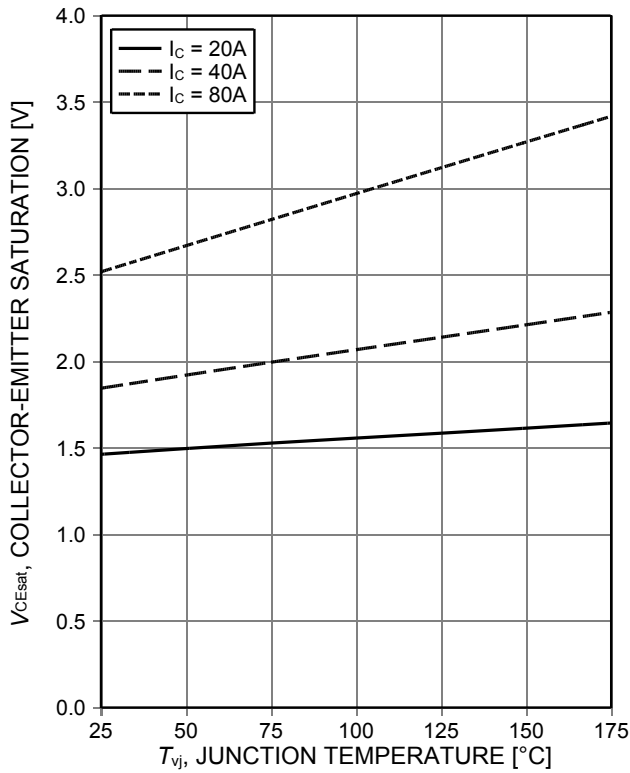

Figure 5. Typical collector-emitter saturation voltage as a function of junction temperature ( $V_{GE}=15V$ )

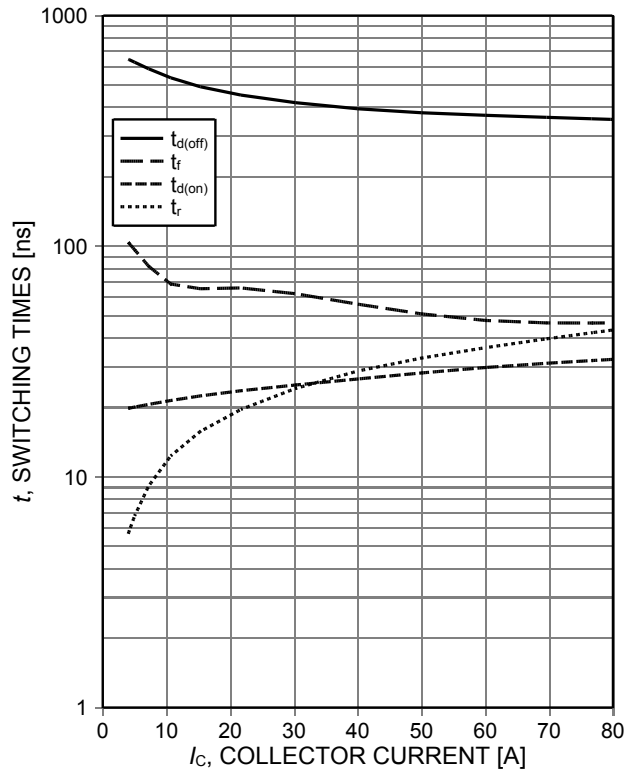

Figure 6. Typical switching times as a function of collector current (inductive load,  $T_{vj}=175^{\circ}C$ ,  $V_{CE}=600V$ ,  $V_{GE}=0/15V$ ,  $R_G=9\Omega$ , Dynamic test circuit in Figure E)

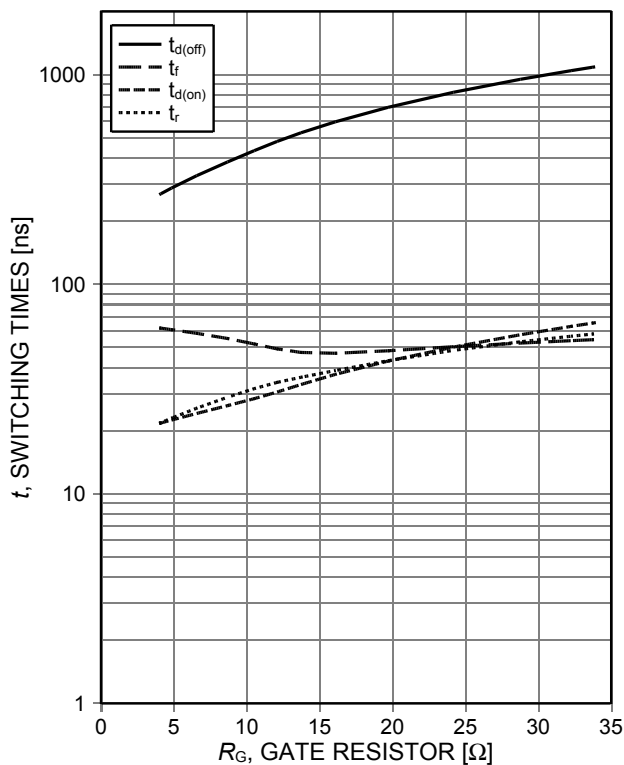

Figure 7. Typical switching times as a function of gate resistor (inductive load,  $T_{vj}=175^{\circ}C$ ,  $V_{CE}=600V$ ,  $V_{GE}=0/15V$ ,  $I_C=40A$ , Dynamic test circuit in Figure E)

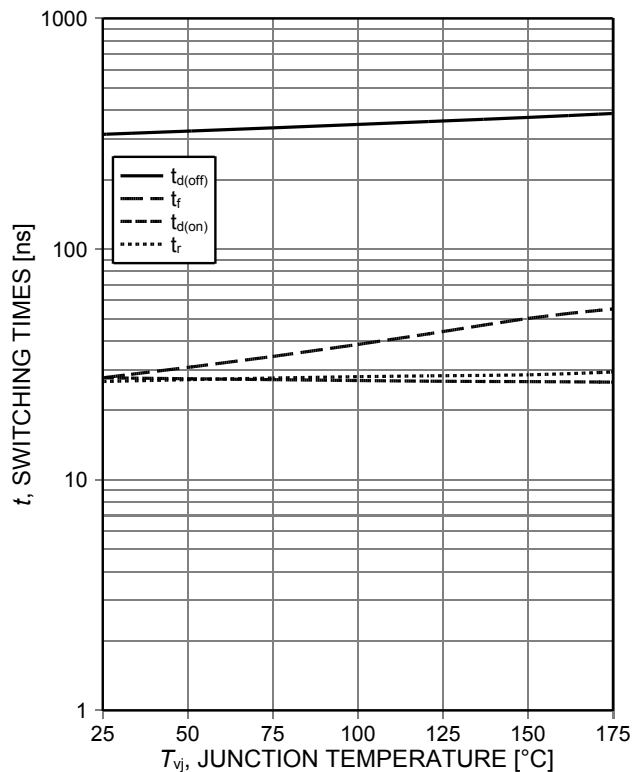

Figure 8. Typical switching times as a function of junction temperature (inductive load,  $V_{CE}=600V$ ,  $V_{GE}=0/15V$ ,  $I_C=40A$ ,  $R_G=9\Omega$ , Dynamic test circuit in Figure E)

Sixth generation, high speed soft switching series

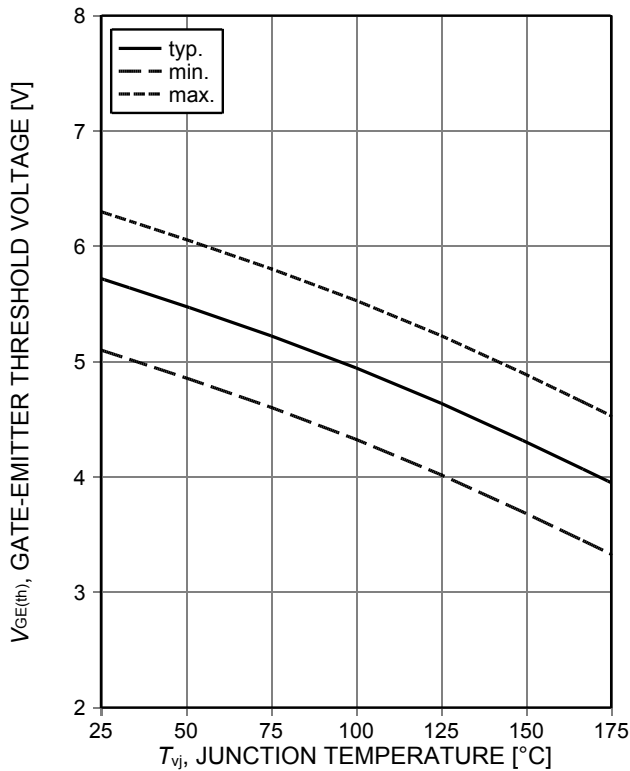

Figure 9. Gate-emitter threshold voltage as a function of junction temperature ( $I_C=1.9mA$ )

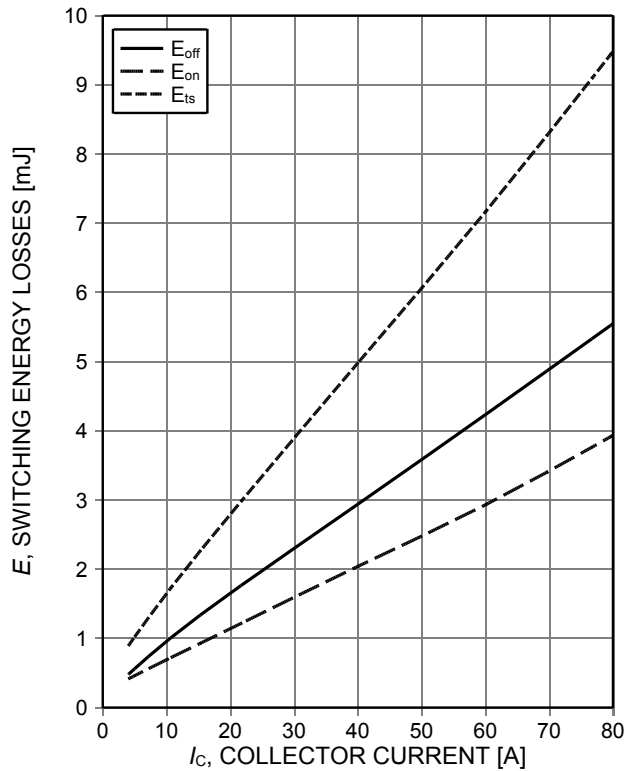

Figure 10. Typical switching energy losses as a function of collector current (inductive load,  $T_{vj}=175^{\circ}C$ ,  $V_{CE}=600V$ ,  $V_{GE}=0/15V$ ,  $R_G=9\Omega$ , Dynamic test circuit in Figure E)

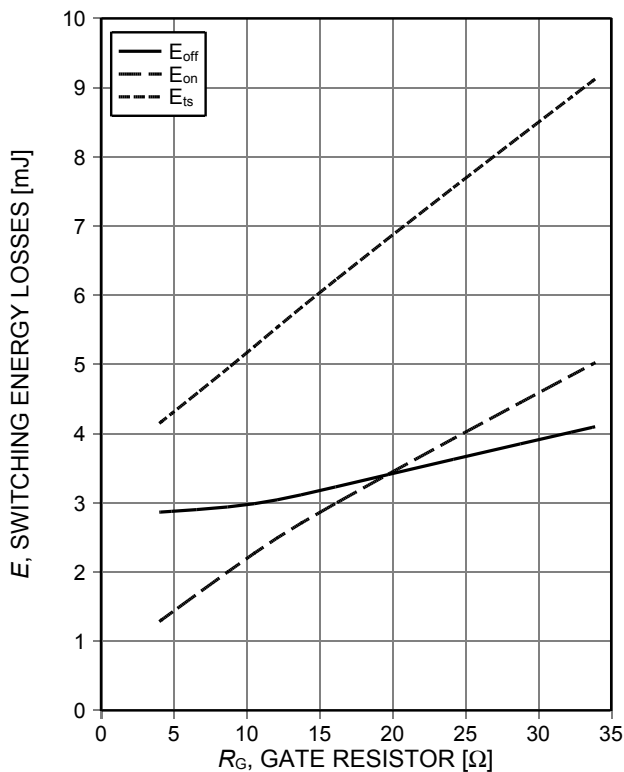

Figure 11. Typical switching energy losses as a function of gate resistor (inductive load,  $T_{vj}=175^{\circ}C$ ,  $V_{CE}=600V$ ,  $V_{GE}=0/15V$ ,  $I_C=40A$ , Dynamic test circuit in Figure E)

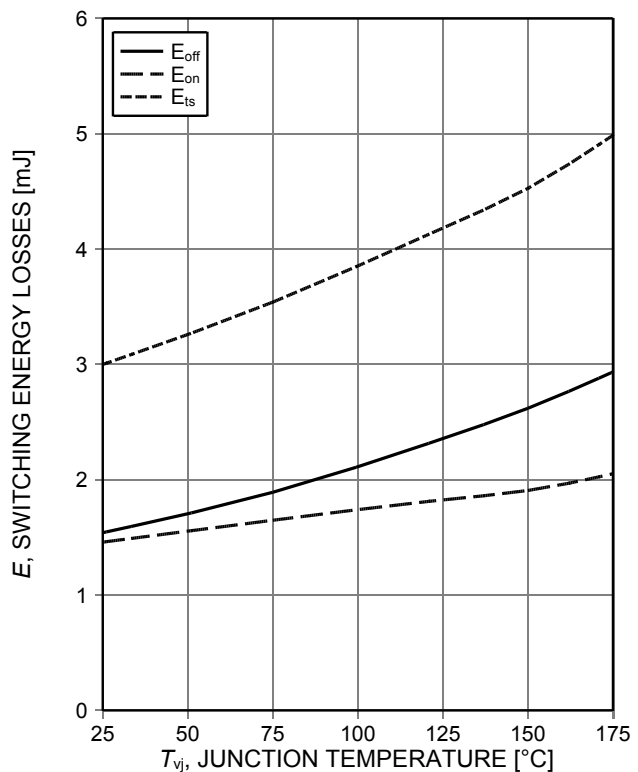

Figure 12. Typical switching energy losses as a function of junction temperature (inductive load,  $V_{CE}=600V$ ,  $V_{GE}=0/15V$ ,  $I_C=40A$ ,  $R_G=9\Omega$ , Dynamic test circuit in Figure E)



Sixth generation, high speed soft switching series

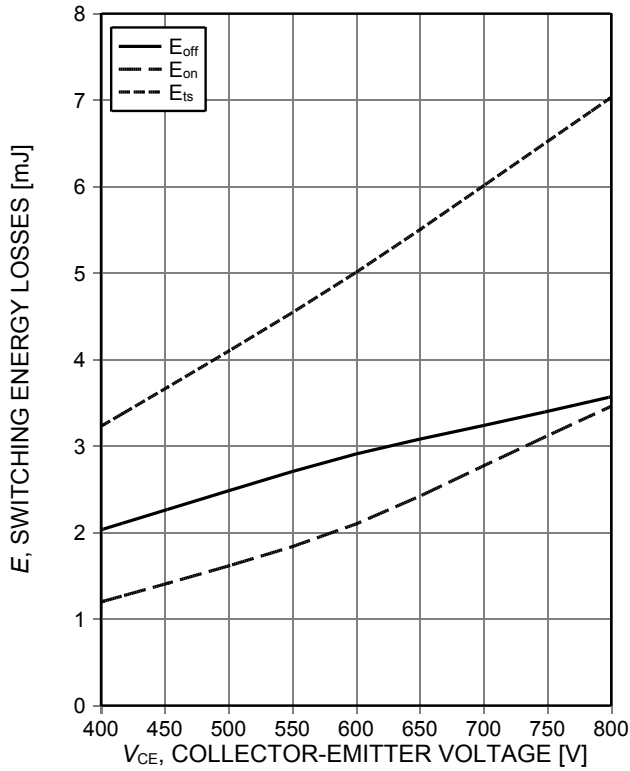

Figure 13. **Typical switching energy losses as a function of collector emitter voltage** (inductive load,  $T_{vj}=175^{\circ}\text{C}$ ,  $V_{GE}=0/15\text{V}$ ,  $I_C=40\text{A}$ ,  $R_G=9\Omega$ , Dynamic test circuit in Figure E)

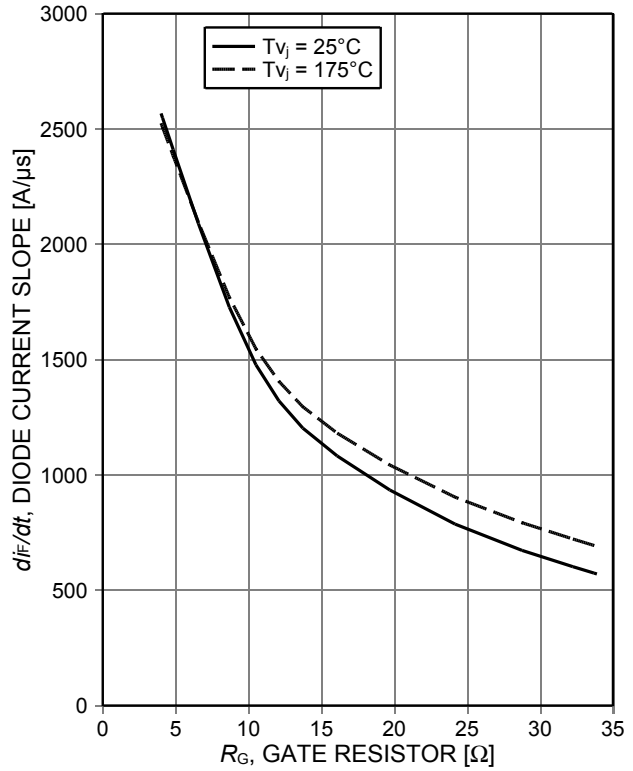

Figure 14. **Typical diode current slope as a function of gate resistor** (inductive load,  $V_{CE}=600\text{V}$ ,  $V_{GE}=0/15\text{V}$ ,  $I_C=40\text{A}$ , Dynamic test circuit in Figure E)

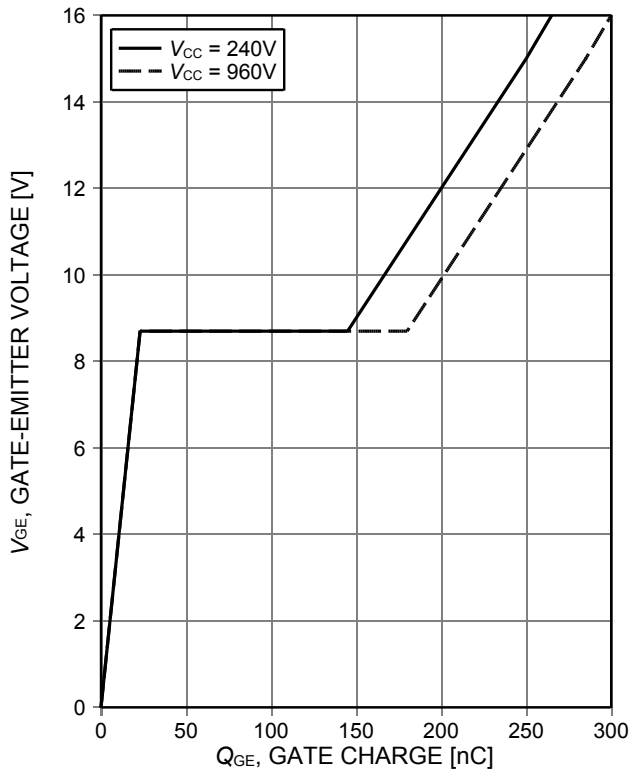

Figure 15. **Typical gate charge** ( $I_C=40\text{A}$ )

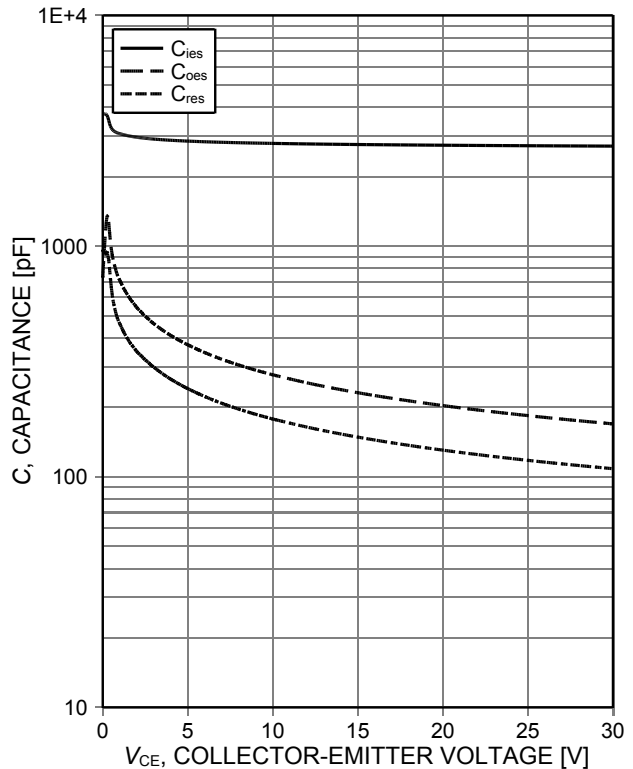

Figure 16. **Typical capacitance as a function of collector-emitter voltage** ( $V_{GE}=0\text{V}$ ,  $f=1\text{MHz}$ )

Sixth generation, high speed soft switching series

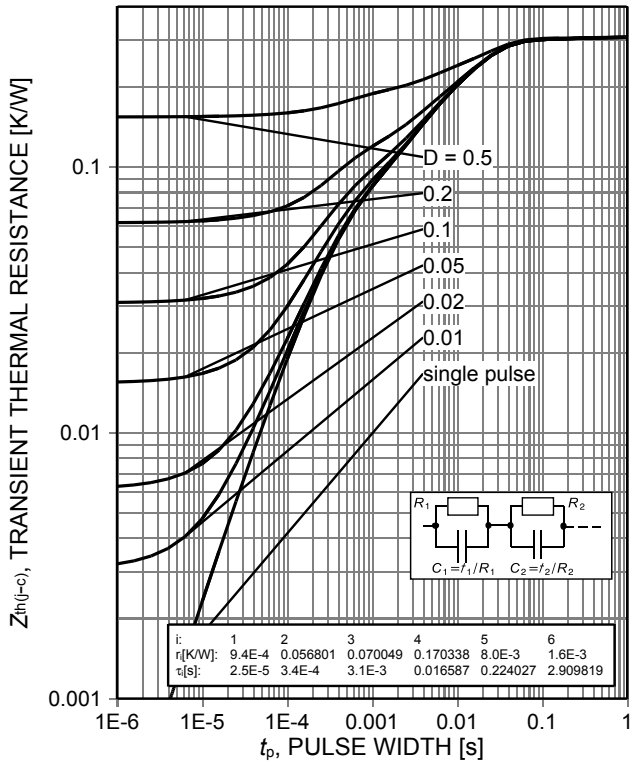

Figure 17. IGBT transient thermal resistance ( $D=t_p/T$ )

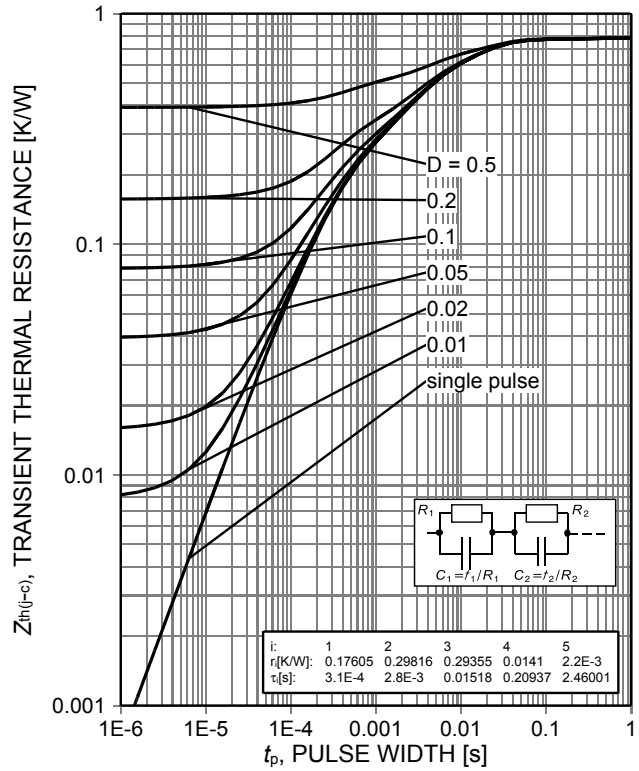

Figure 18. Diode transient thermal impedance as a function of pulse width ( $D=t_p/T$ )

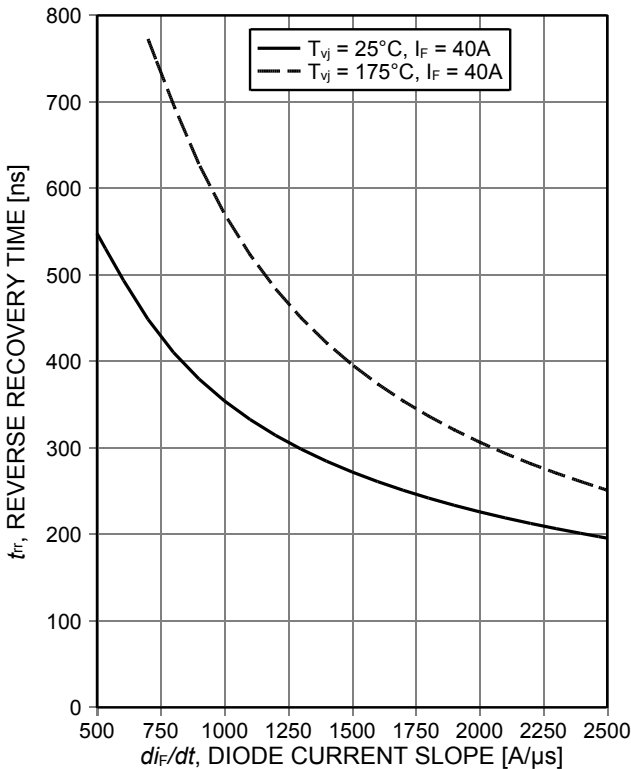

Figure 19. Typical reverse recovery time as a function of diode current slope ( $V_R=600V$ )

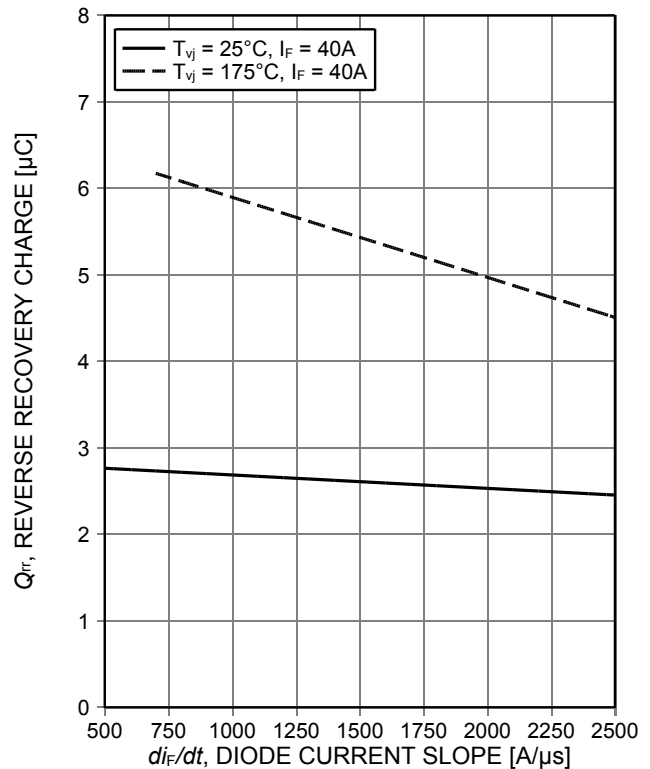

Figure 20. Typical reverse recovery charge as a function of diode current slope ( $V_R=600V$ )

Sixth generation, high speed soft switching series

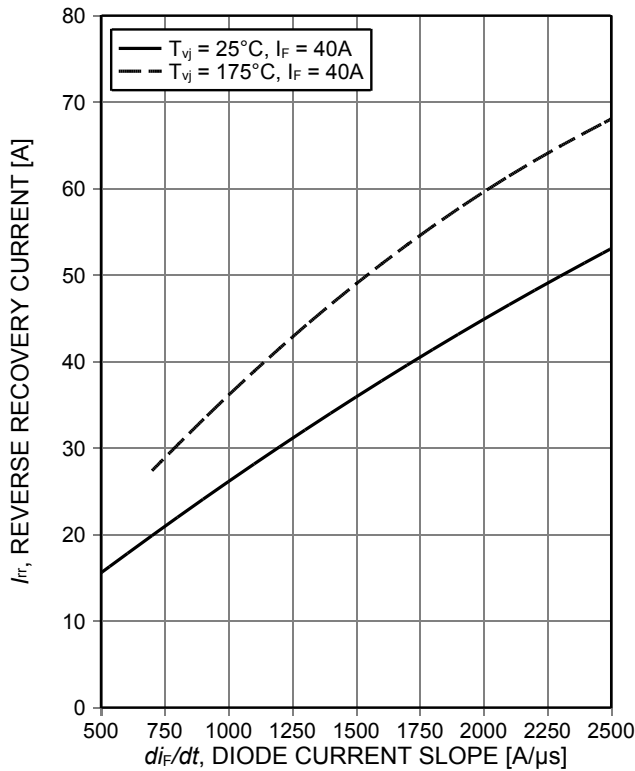

Figure 21. Typical reverse recovery current as a function of diode current slope (V<sub>R</sub>=600V)

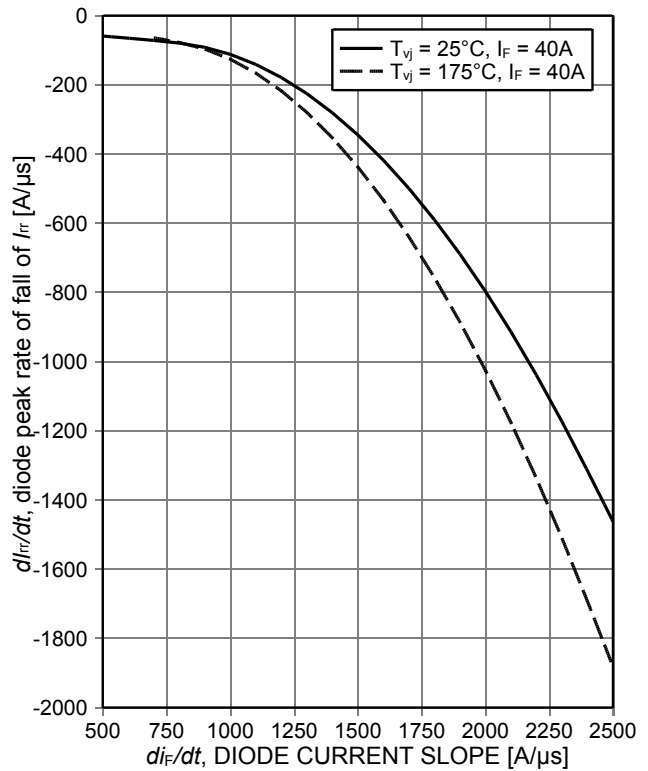

Figure 22. Typical diode peak rate of fall of reverse recovery current as a function of diode current slope (V<sub>R</sub>=600V)

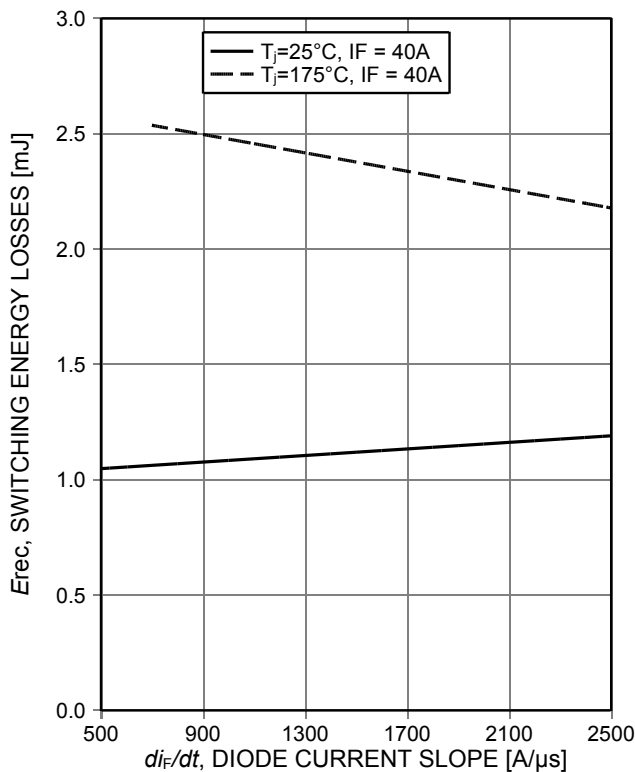

Figure 23. Typical reverse energy losses as a function of diode current slope (V<sub>R</sub>=600V)

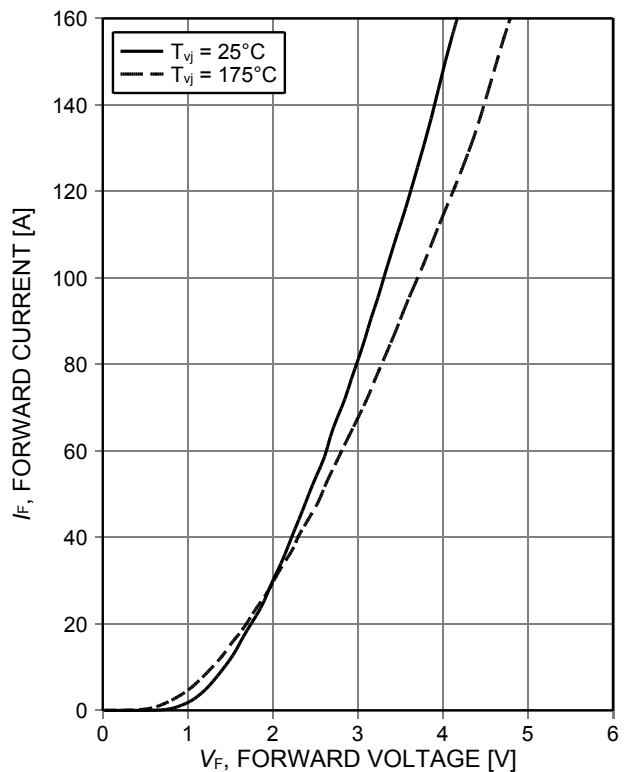

Figure 24. Typical diode forward current as a function of forward voltage

Sixth generation, high speed soft switching series

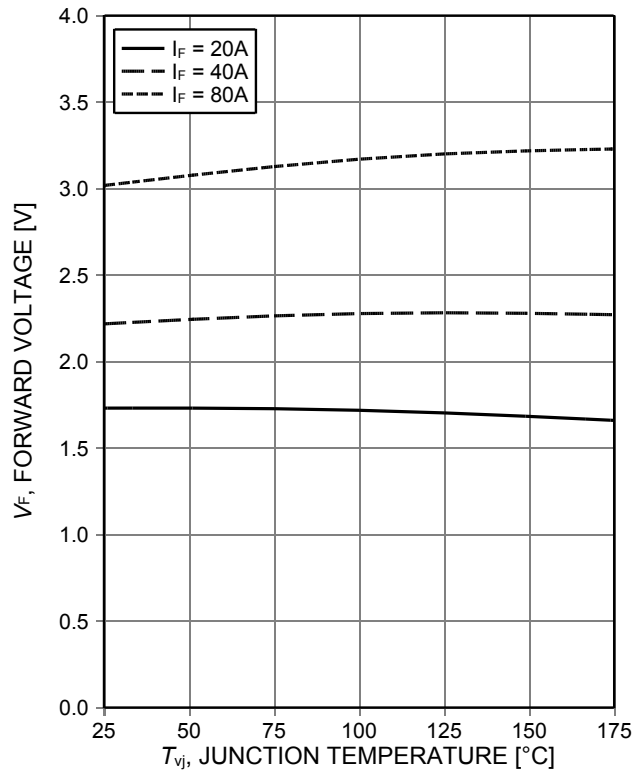
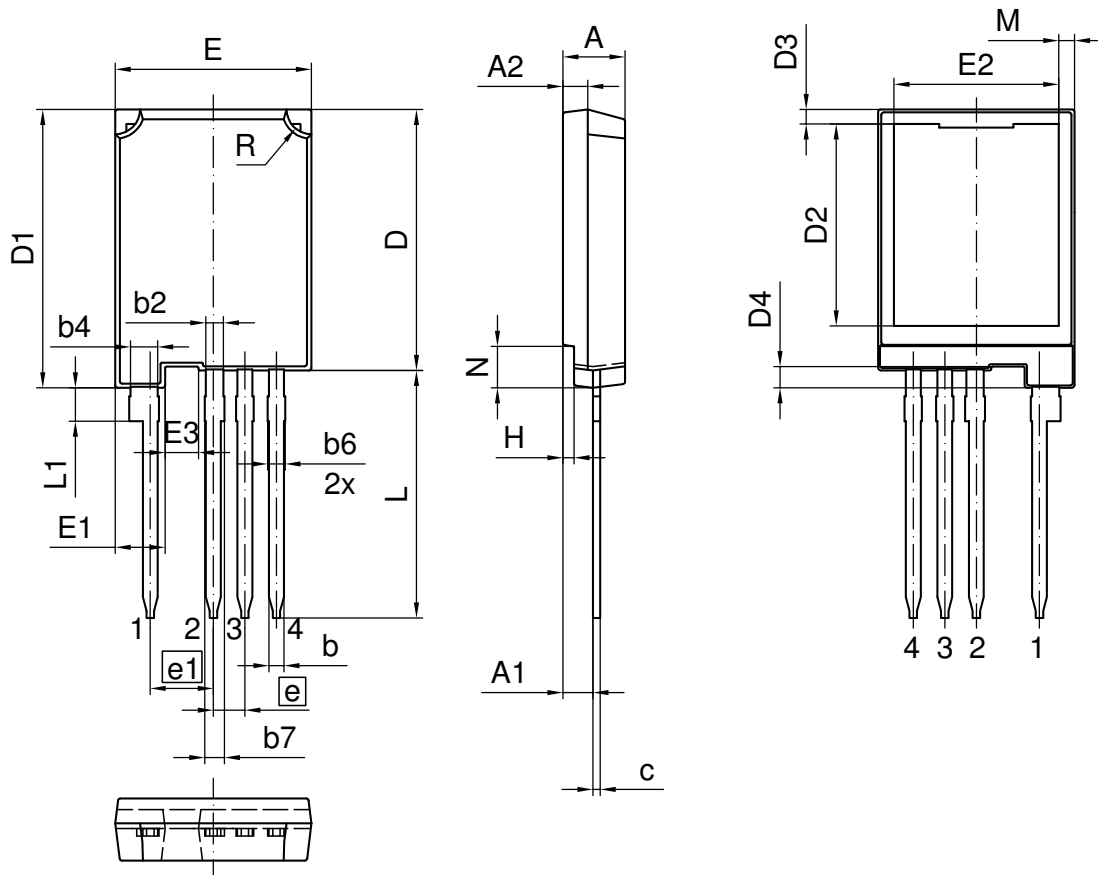

Figure 25. Typical diode forward voltage as a function of junction temperature

**PG-TO247-4-2**



**NOTES:**

PACKAGE SURFACE ROUTE BETWEEN PIN 1 & PIN 2 WILL BE 5.1mm MIN.

ALL b... AND c DIMENSIONS INCLUDING PLATING EXCEPT AREA OF CUTTING

DIMENSION	MILLIMETERS	
	MIN.	MAX.
A	4.9	5.1
A1	2.31	2.51
A2	1.9	2.1
b	1.16	1.29
b2	1.36	1.49
b4	2.16	2.29
b6	1.16	1.45
b7	1.16	1.65
c	0.59	0.66
D	20.9	21.1
D1	22.3	22.5
D2	15.95	16.55
D3	1	1.35
D4	1.6	1.8
E	15.7	15.9
E1	3.9	4.1
E2	13.1	13.5
E3	2.58	2.78
e	2.54	
e1	5.08	
H	0.8	1
L	19.8	20.1
L1	2.55	2.85
M	0.97	1.57
N	3.24	3.44
R	1.9	2.1

<b>DOCUMENT NO.</b> Z8B00182798
<b>REVISION</b> 01
<b>SCALE 2:1</b> 
<b>EUROPEAN PROJECTION</b> 
<b>ISSUE DATE</b> 23.09.2016

Testing Conditions



Figure A. Definition of switching times



Figure B. Definition of switching losses

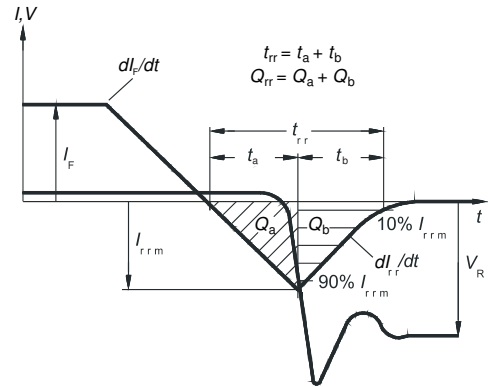

Figure C. Definition of diode switching characteristics

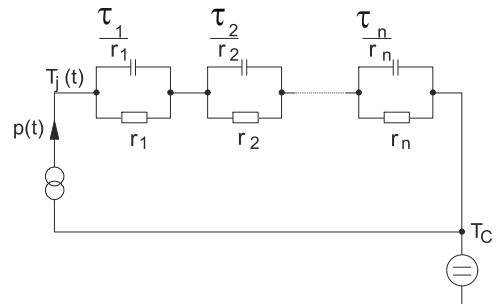

Figure D. Thermal equivalent circuit



Figure E. Dynamic test circuit  
Parasitic inductance  $L_{\sigma}$ ,  
parasitic capacitor  $C_{\sigma}$ ,  
relief capacitor  $C_r$ ,  
(only for ZVT switching)

---

Sixth generation, high speed soft switching series

## Revision History

---

IKY40N120CS6

**Revision: 2018-05-07, Rev. 2.1**

---

Previous Revision

Revision	Date	Subjects (major changes since last revision)
2.1	2018-05-07	Final data sheet

## Trademarks

All referenced product or service names and trademarks are the property of their respective owners.

**Published by**  
**Infineon Technologies AG**  
**81726 München, Germany**  
**© Infineon Technologies AG 2018.**  
**All Rights Reserved.**

## Important Notice

The information given in this document shall in no event be regarded as a guarantee of conditions or characteristics ("Beschaffenheitsgarantie"). With respect to any examples, hints or any typical values stated herein and/or any information regarding the application of the product, Infineon Technologies hereby disclaims any and all warranties and liabilities of any kind, including without limitation warranties of non-infringement of intellectual property rights of any third party.

In addition, any information given in this document is subject to customer's compliance with its obligations stated in this document and any applicable legal requirements, norms and standards concerning customer's products and any use of the product of Infineon Technologies in customer's applications.

The data contained in this document is exclusively intended for technically trained staff. It is the responsibility of customer's technical departments to evaluate the suitability of the product for the intended application and the completeness of the product information given in this document with respect to such application.

For further information on the product, technology, delivery terms and conditions and prices please contact your nearest Infineon Technologies office ([www.infineon.com](http://www.infineon.com)).

Please note that this product is not qualified according to the AEC Q100 or AEC Q101 documents of the Automotive Electronics Council.

## Warnings

Due to technical requirements products may contain dangerous substances. For information on the types in question please contact your nearest Infineon Technologies office.

Except as otherwise explicitly approved by Infineon Technologies in a written document signed by authorized representatives of Infineon Technologies, Infineon Technologies' products may not be used in any applications where a failure of the product or any consequences of the use thereof can reasonably be expected to result in personal injury.