

IRL6342PbF

HEXFET® Power MOSFET

V_{DS}	30	V
V_{GS}	±12	V
$R_{DS(on) max}$ (@ $V_{GS} = 4.5V$)	14.6	mΩ
Q_g (typical)	11	nC
I_D (@ $T_A = 25°C$)	9.9	A

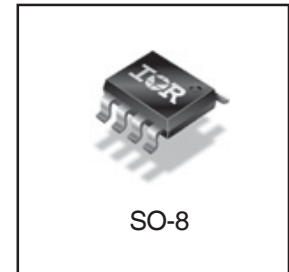
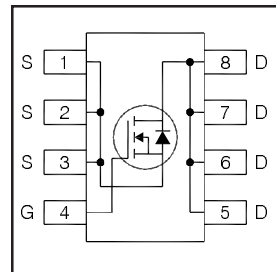

Applications

- Battery operated DC motor inverter MOSFET
- System/Load Switch

Features and Benefits

Features

Industry-Standard SO-8 Package
RoHS Compliant Containing no Lead, no Bromide and no Halogen
MSL1, Consumer Qualification



Resulting Benefits

Multi-Vendor Compatibility
Environmentally Friendlier
Increased Reliability

Orderable part number	Package Type	Standard Pack		Note
		Form	Quantity	
IRL6342PBF	SO-8	Tube/Bulk	95	
IRL6342TRPBF	SO-8	Tape and Reel	4000	

Absolute Maximum Ratings

	Parameter	Max.	Units
V_{DS}	Drain-to-Source Voltage	30	V
V_{GS}	Gate-to-Source Voltage	±12	
$I_D @ T_A = 25°C$	Continuous Drain Current, $V_{GS} @ 4.5V$	9.9	A
$I_D @ T_A = 70°C$	Continuous Drain Current, $V_{GS} @ 4.5V$	7.9	
I_{DM}	Pulsed Drain Current ①	79	
$P_D @ T_A = 25°C$	Power Dissipation ③	2.5	W
$P_D @ T_A = 70°C$	Power Dissipation ③	1.6	
	Linear Derating Factor	0.02	W/°C
T_J	Operating Junction and	-55 to + 150	°C
T_{STG}	Storage Temperature Range		

Notes ① through ④ are on page 2

Static @ $T_J = 25^\circ\text{C}$ (unless otherwise specified)

	Parameter	Min.	Typ.	Max.	Units	Conditions
BV_{DSS}	Drain-to-Source Breakdown Voltage	30	—	—	V	$V_{GS} = 0V, I_D = 250\mu A$
$\Delta BV_{DSS}/\Delta T_J$	Breakdown Voltage Temp. Coefficient	—	22	—	mV/°C	Reference to $25^\circ\text{C}, I_D = 1mA$
$R_{DS(on)}$	Static Drain-to-Source On-Resistance	—	12.0	14.6	mΩ	$V_{GS} = 4.5V, I_D = 9.9A$ ②
		—	15.0	19.0		$V_{GS} = 2.5V, I_D = 7.9A$ ②
$V_{GS(th)}$	Gate Threshold Voltage	0.5	—	1.1	V	$V_{DS} = V_{GS}, I_D = 10\mu A$
$\Delta V_{GS(th)}$	Gate Threshold Voltage Coefficient	—	-4.2	—	mV/°C	
I_{DSS}	Drain-to-Source Leakage Current	—	—	1.0	μA	$V_{DS} = 24V, V_{GS} = 0V$
		—	—	150		$V_{DS} = 24V, V_{GS} = 0V, T_J = 125^\circ\text{C}$
I_{GSS}	Gate-to-Source Forward Leakage	—	—	100	nA	$V_{GS} = 12V$
	Gate-to-Source Reverse Leakage	—	—	-100		$V_{GS} = -12V$
g_{fs}	Forward Transconductance	38	—	—	S	$V_{DS} = 10V, I_D = 7.9A$
Q_g	Total Gate Charge	—	11	—	nC	$V_{GS} = 4.5V$ $V_{DS} = 15V$ $I_D = 7.9A$
Q_{gs1}	Pre-V _{th} Gate-to-Source Charge	—	0.01	—		
Q_{gs2}	Post-V _{th} Gate-to-Source Charge	—	0.60	—		
Q_{gd}	Gate-to-Drain Charge	—	4.6	—		
Q_{godr}	Gate Charge Overdrive	—	5.79	—		
Q_{sw}	Switch Charge ($Q_{gs2} + Q_{gd}$)	—	5.2	—		
R_G	Gate Resistance	—	2.0	—	Ω	
$t_{d(on)}$	Turn-On Delay Time	—	6.0	—	ns	$V_{DD} = 15V, V_{GS} = 4.5V$ ③ $I_D = 7.9A$ $R_G = 6.8\Omega$ See Figs. 18
t_r	Rise Time	—	12	—		
$t_{d(off)}$	Turn-Off Delay Time	—	33	—		
t_f	Fall Time	—	14	—		
C_{iss}	Input Capacitance	—	1025	—	pF	$V_{GS} = 0V$ $V_{DS} = 25V$ $f = 1.0MHz$
C_{oss}	Output Capacitance	—	97	—		
C_{rss}	Reverse Transfer Capacitance	—	70	—		

Diode Characteristics

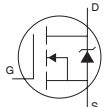
	Parameter	Min.	Typ.	Max.	Units	Conditions
I_S	Continuous Source Current (Body Diode)	—	—	2.5	A	MOSFET symbol showing the integral reverse p-n junction diode. 
I_{SM}	Pulsed Source Current (Body Diode) ①	—	—	79		
V_{SD}	Diode Forward Voltage	—	—	1.2	V	$T_J = 25^\circ\text{C}, I_S = 9.9A, V_{GS} = 0V$ ②
t_{rr}	Reverse Recovery Time	—	13	20	ns	$T_J = 25^\circ\text{C}, I_F = 7.9A, V_{DD} = 24V$
Q_{rr}	Reverse Recovery Charge	—	5.2	7.8	nC	$di/dt = 100/\mu s$ ②

Thermal Resistance

	Parameter	Typ.	Max.	Units
$R_{\theta JL}$	Junction-to-Drain Lead ④	—	20	°C/W
$R_{\theta JA}$	Junction-to-Ambient ③	—	50	

Notes:

- ① Repetitive rating; pulse width limited by max. junction temperature.
- ② Pulse width $\leq 400\mu s$; duty cycle $\leq 2\%$.
- ③ When mounted on 1 inch square copper board.
- ④ R_{θ} is measured at T_J of approximately 90°C .

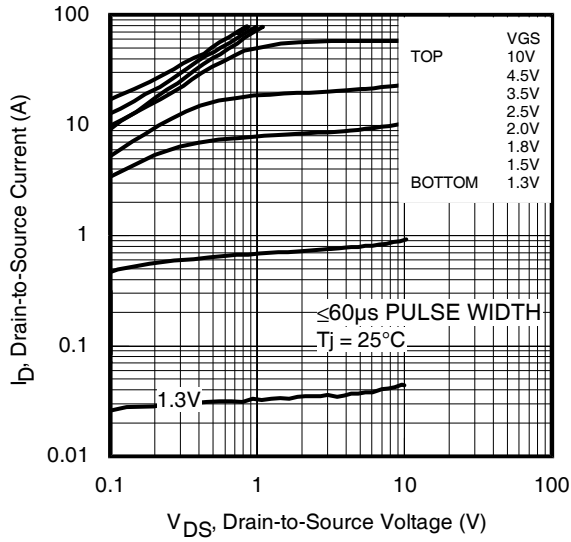

Fig 1. Typical Output Characteristics

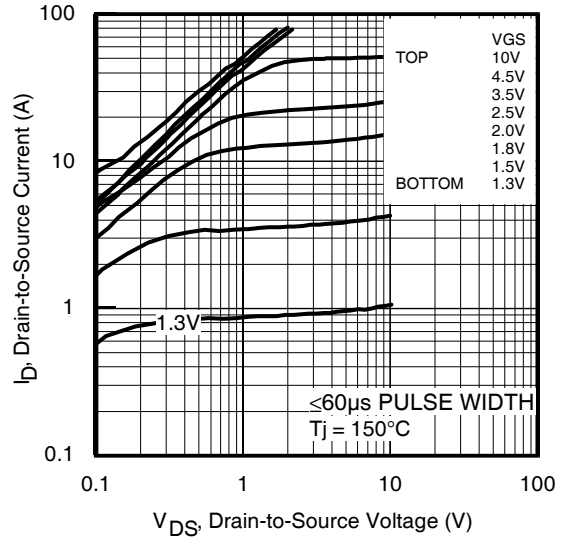

Fig 2. Typical Output Characteristics

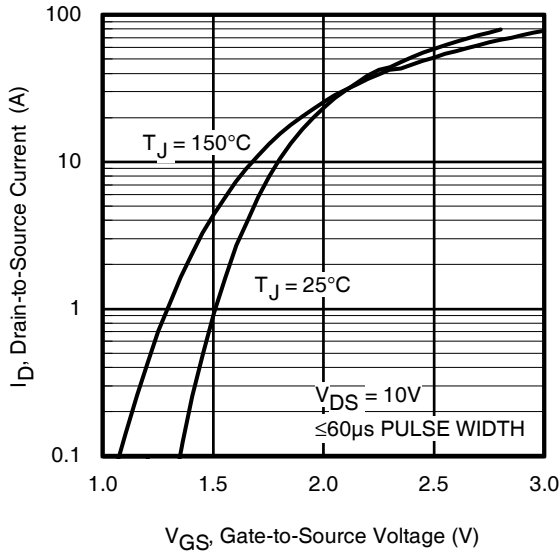

Fig 3. Typical Transfer Characteristics

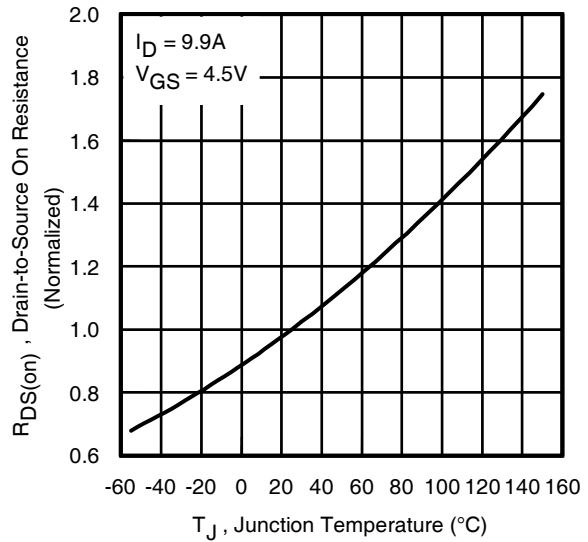

Fig 4. Normalized On-Resistance vs. Temperature

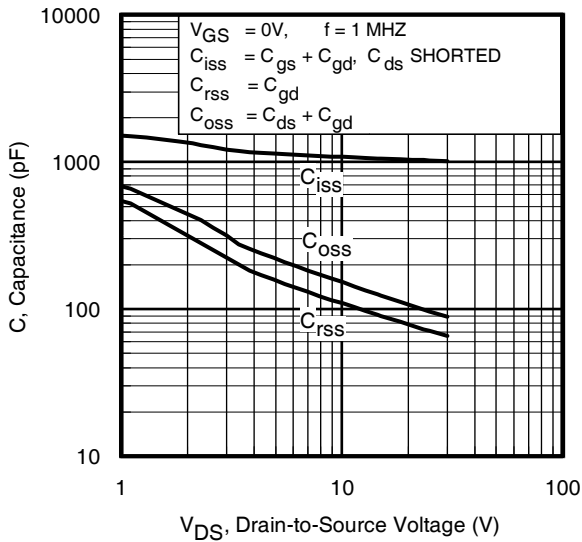

Fig 5. Typical Capacitance vs. Drain-to-Source Voltage
www.irf.com

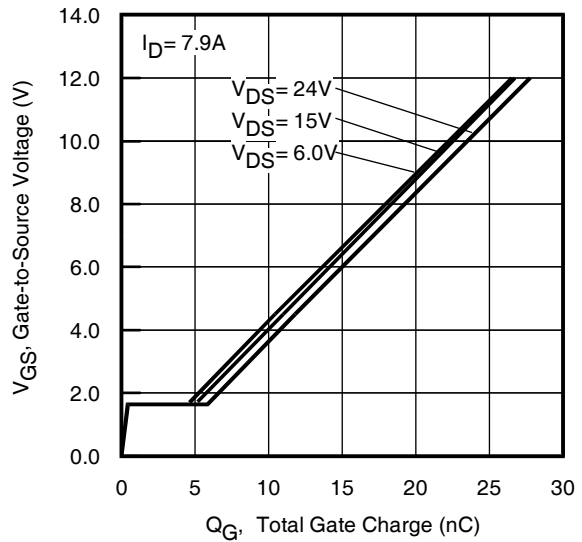

Fig 6. Typical Gate Charge vs. Gate-to-Source Voltage

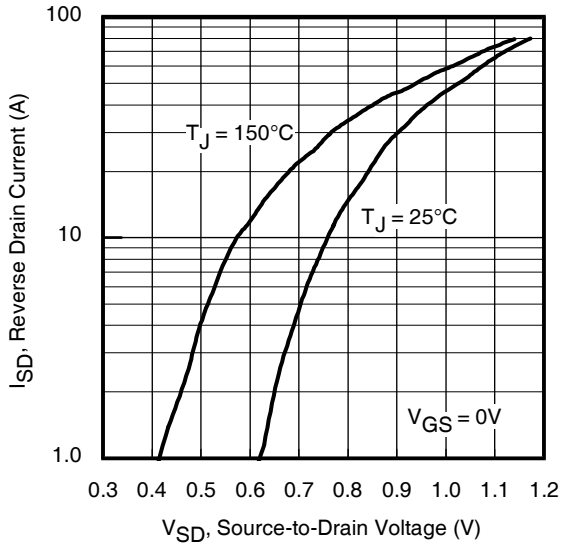

Fig 7. Typical Source-Drain Diode Forward Voltage

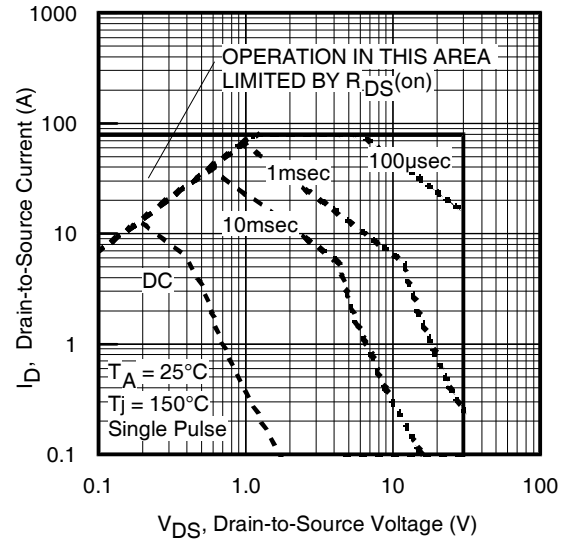

Fig 8. Maximum Safe Operating Area

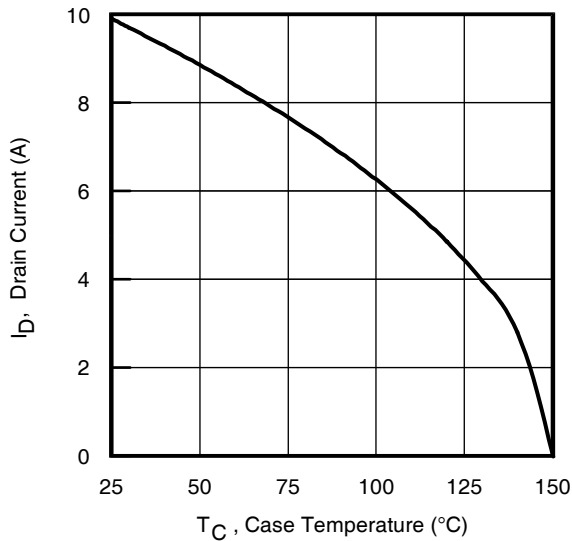

Fig 9. Maximum Drain Current vs. Case (Bottom) Temperature

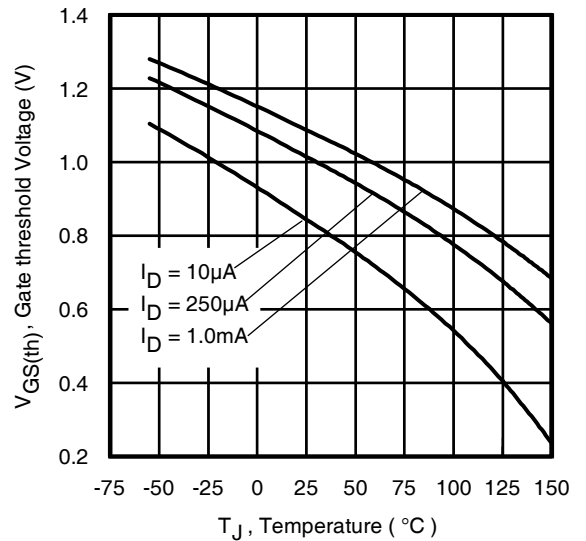

Fig 10. Threshold Voltage vs. Temperature

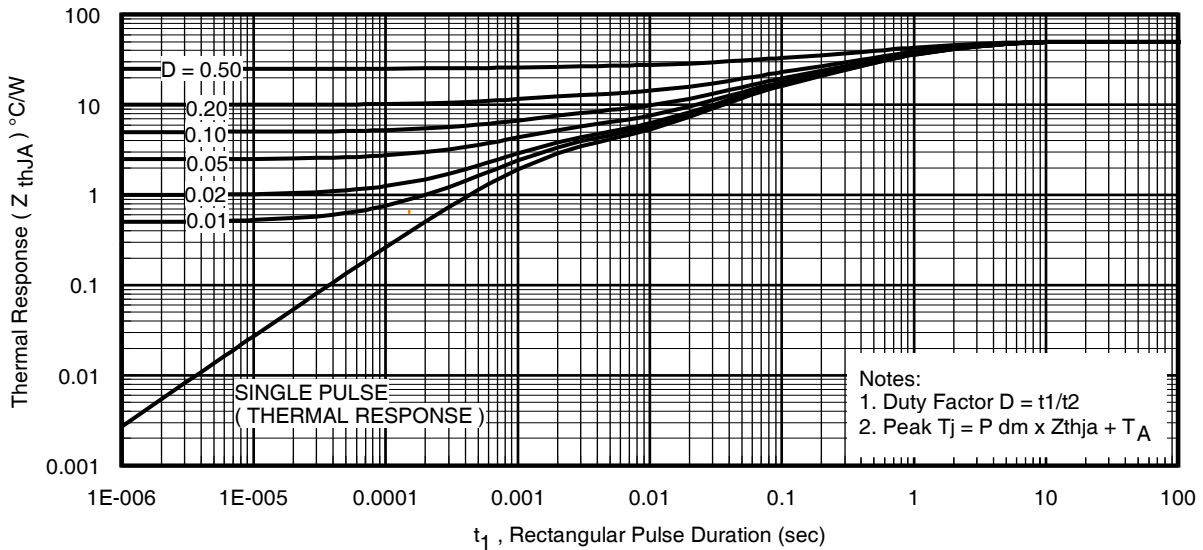

Fig 11. Maximum Effective Transient Thermal Impedance, Junction-to-Case (Bottom)

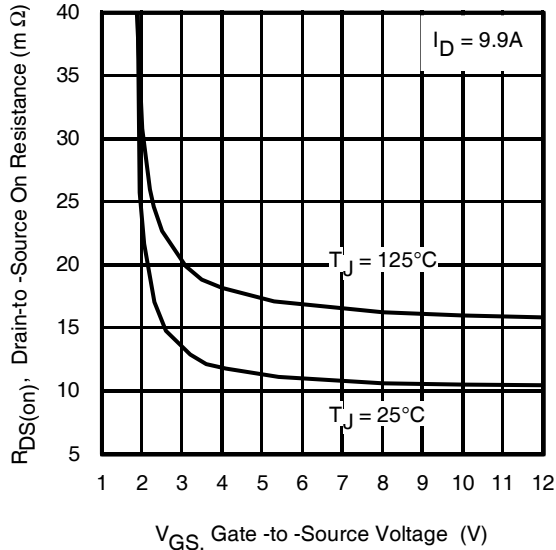

Fig 12. On-Resistance vs. Gate Voltage

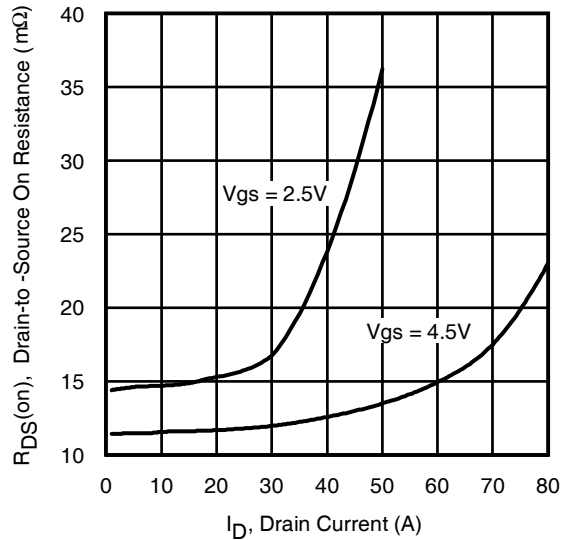

Fig 13. Typical On-Resistance vs. Drain Current

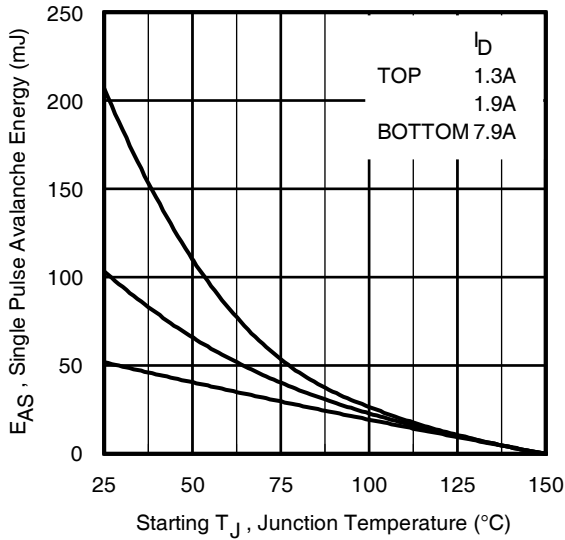

Fig 14. Maximum Avalanche Energy vs. Drain Current

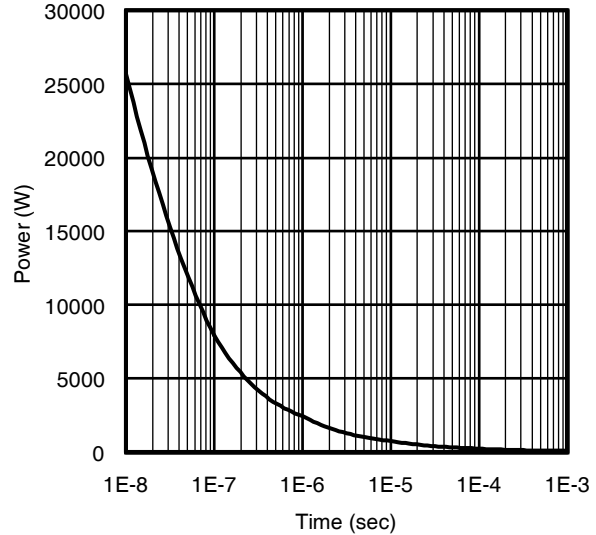
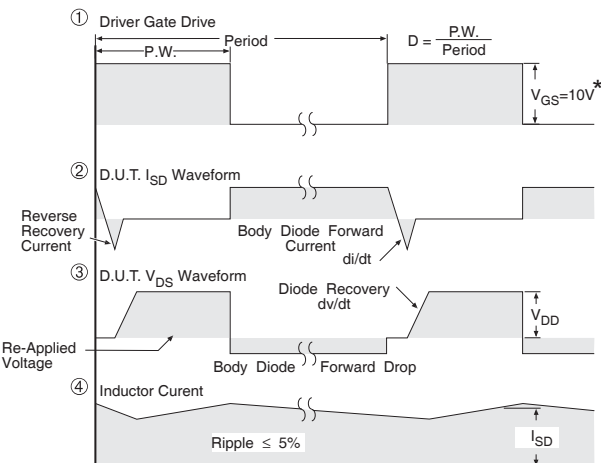
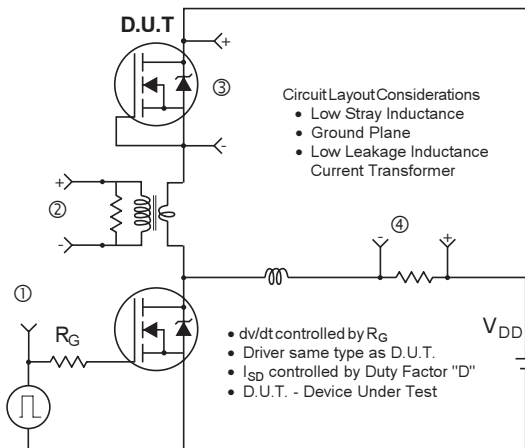

Fig 15. Typical Power vs. Time



* $V_{GS} = 5V$ for Logic Level Devices

Fig 16. Peak Diode Recovery dv/dt Test Circuit for N-Channel
HEXFET® Power MOSFETs

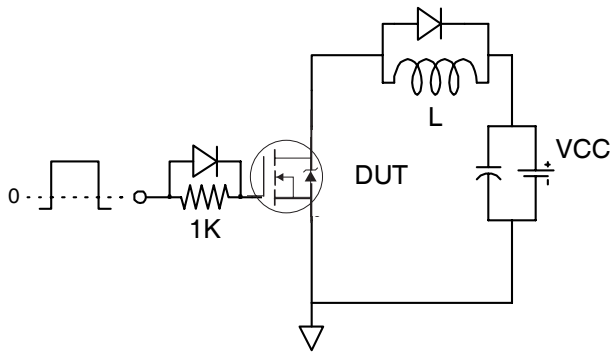

Fig 17a. Gate Charge Test Circuit

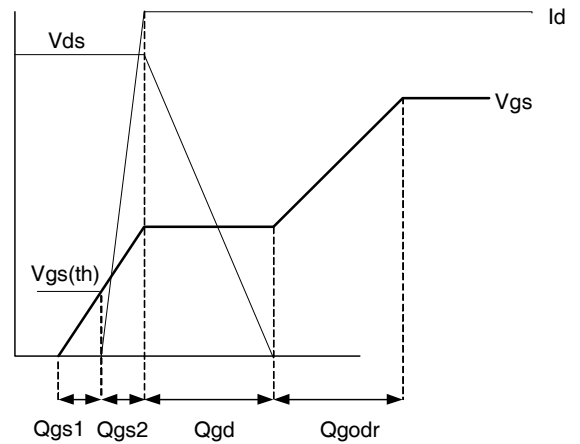

Fig 17b. Gate Charge Waveform

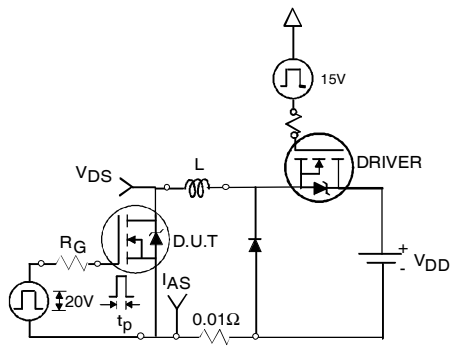

Fig 18a. Unclamped Inductive Test Circuit

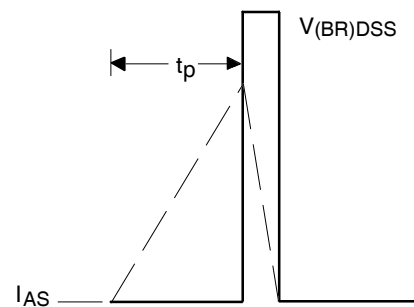

Fig 18b. Unclamped Inductive Waveforms

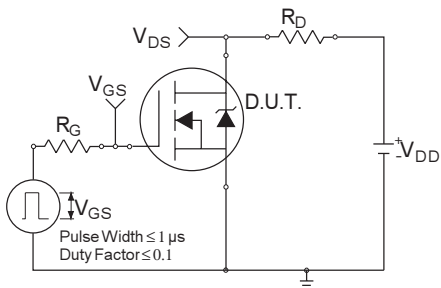

Fig 19a. Switching Time Test Circuit

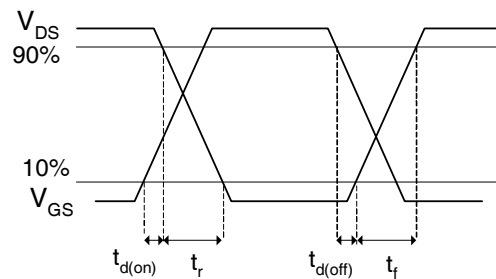
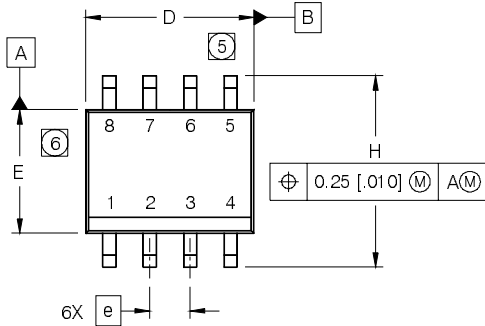

Fig 19b. Switching Time Waveforms

SO-8 Package Outline (Mosfet & Fetky)

Dimensions are shown in millimeters (inches)



DIM	INCHES		MILLIMETERS	
	MIN	MAX	MIN	MAX
A	.0532	.0688	1.35	1.75
A1	.0040	.0098	0.10	0.25
b	.013	.020	0.33	0.51
c	.0075	.0098	0.19	0.25
D	.189	.1968	4.80	5.00
E	.1497	.1574	3.80	4.00
e	.050 BASIC		1.27 BASIC	
e1	.025 BASIC		0.635 BASIC	
H	.2284	.2440	5.80	6.20
K	.0099	.0196	0.25	0.50
L	.016	.050	0.40	1.27
y	0°	8°	0°	8°

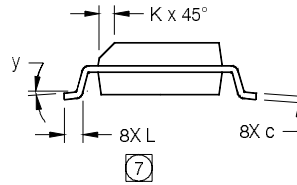
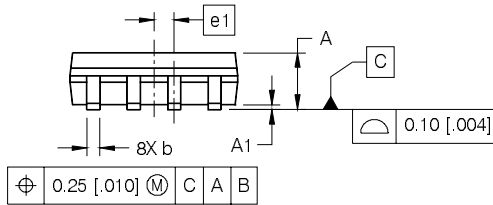

NOTES:

1. DIMENSIONING & TOLERANCING PER ASME Y14.5M-1994.
2. CONTROLLING DIMENSION: MILLIMETER
3. DIMENSIONS ARE SHOWN IN MILLIMETERS [INCHES].
4. OUTLINE CONFORMS TO JEDEC OUTLINE MS-012AA.
5. DIMENSION DOES NOT INCLUDE MOLD PROTRUSIONS. MOLD PROTRUSIONS NOT TO EXCEED 0.15 [.006].
6. DIMENSION DOES NOT INCLUDE MOLD PROTRUSIONS. MOLD PROTRUSIONS NOT TO EXCEED 0.25 [.010].
7. DIMENSION IS THE LENGTH OF LEAD FOR SOLDERING TO A SUBSTRATE.

FOOTPRINT

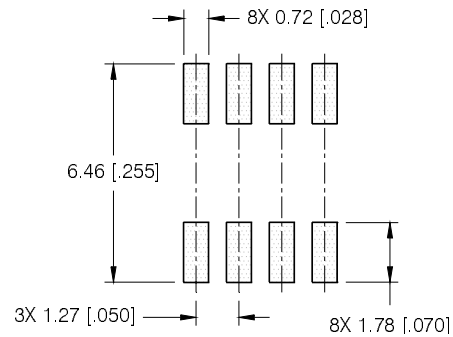

SO-8 Part Marking Information

EXAMPLE: THIS IS AN IRF7101 (MOSFET)

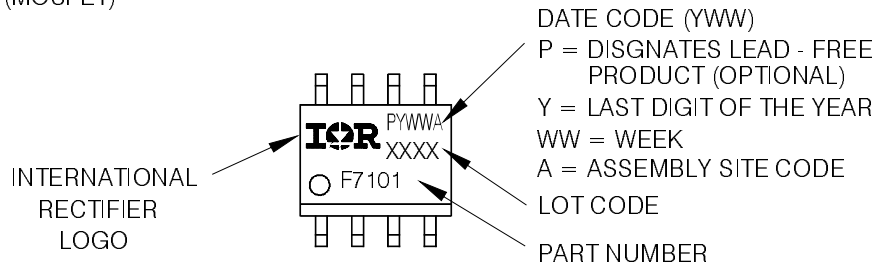

Note: For the most current drawing please refer to IR website at: <http://www.irf.com/package/>

SO-8 Tape and Reel

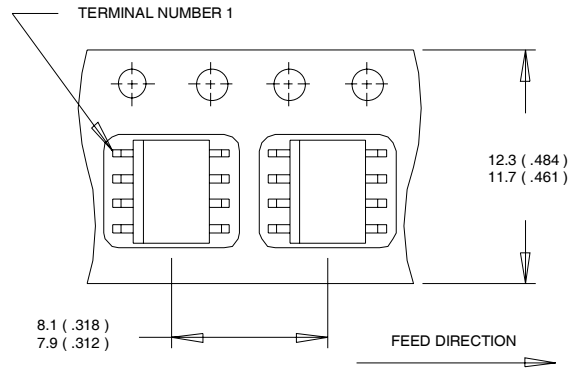

- NOTES:
1. CONTROLLING DIMENSION : MILLIMETER.
 2. ALL DIMENSIONS ARE SHOWN IN MILLIMETERS(INCHES).
 3. OUTLINE CONFORMS TO EIA-481 & EIA-541.

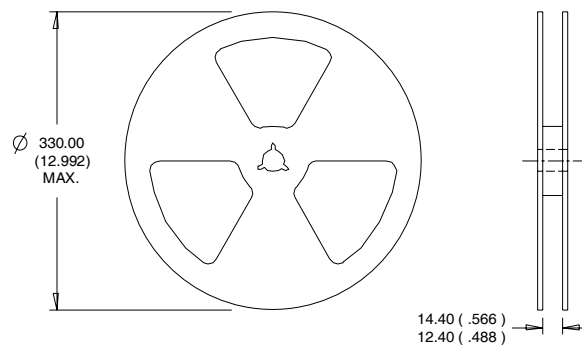

- NOTES :
1. CONTROLLING DIMENSION : MILLIMETER.
 2. OUTLINE CONFORMS TO EIA-481 & EIA-541.

Qualification information[†]

Qualification level	Consumer ^{††} (per JEDEC JESD47F ^{†††} guidelines)	
Moisture Sensitivity Level	SO-8	MSL1 (per JEDEC J-STD-020D ^{†††})
RoHS compliant	Yes	

[†] Qualification standards can be found at International Rectifier's web site
<http://www.irf.com/product-info/reliability>

^{††} Higher qualification ratings may be available should the user have such requirements.
Please contact your International Rectifier sales representative for further information:
<http://www.irf.com/whoto-call/salesrep/>

^{†††} Applicable version of JEDEC standard at the time of product release.

Data and specifications subject to change without notice.

International
IR Rectifier

IR WORLD HEADQUARTERS: 233 Kansas St., El Segundo, California 90245, USA Tel: (310) 252-7105
TAC Fax: (310) 252-7903

Visit us at www.irf.com for sales contact information.01/2011

www.irf.com

IMPORTANT NOTICE

The information given in this document shall in no event be regarded as a guarantee of conditions or characteristics ("Beschaffheitsgarantie").

With respect to any examples, hints or any typical values stated herein and/or any information regarding the application of the product, Infineon Technologies hereby disclaims any and all warranties and liabilities of any kind, including without limitation warranties of non-infringement of intellectual property rights of any third party.

In addition, any information given in this document is subject to customer's compliance with its obligations stated in this document and any applicable legal requirements, norms and standards concerning customer's products and any use of the product of Infineon Technologies in customer's applications.

The data contained in this document is exclusively intended for technically trained staff. It is the responsibility of customer's technical departments to evaluate the suitability of the product for the intended application and the completeness of the product information given in this document with respect to such application.

For further information on the product, technology, delivery terms and conditions and prices please contact your nearest Infineon Technologies office (www.infineon.com).

WARNINGS

Due to technical requirements products may contain dangerous substances. For information on the types in question please contact your nearest Infineon Technologies office.

Except as otherwise explicitly approved by Infineon Technologies in a written document signed by authorized representatives of Infineon Technologies, Infineon Technologies' products may not be used in any applications where a failure of the product or any consequences of the use thereof can reasonably be expected to result in personal injury.