

1 CHANNEL LOW CAPACITANCE TVS DIODE ARRAY

Features

- IEC 61000-4-2 (ESD): Air – ±15kV, Contact – ±8kV
- 1 Channel of ESD Protection
- Low Channel Input Capacitance of 0.85pF Typical
- Typically Used at High Speed Ports such as USB 2.0, IEEE1394, Serial ATA, DVI, HDMI, PCI
- **Totally Lead-Free & Fully RoHS Compliant (Notes 1 & 2)**
- **Halogen and Antimony Free. "Green" Device (Note 3)**
- **Qualified to AEC-Q101 Standards for High Reliability**

Mechanical Data

- Case: SOT23
- Case Material: Molded Plastic, "Green" Molding Compound. UL Flammability Classification Rating 94V-0
- Moisture Sensitivity: Level 1 per J-STD-020
- Terminals: Matte Tin Finish annealed over Alloy 42 leadframe (Lead Free Plating). Solderable per MIL-STD-202, Method 208 **e3**
- Weight: 0.0089 grams (approximate)

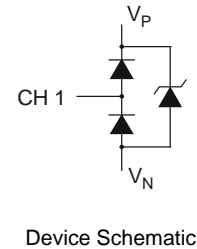
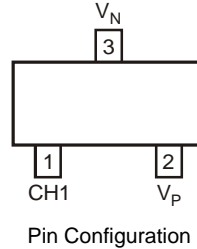

Ordering Information (Note 4)

Part Number	Case	Packaging
D1213A-01SO-7	SOT23	3000/Tape & Reel

- Notes:
1. No purposely added lead. Fully EU Directive 2002/95/EC (RoHS) & 2011/65/EU (RoHS 2) compliant.
 2. See <http://www.diodes.com> for more information about Diodes Incorporated's definitions of Halogen- and Antimony-free, "Green" and Lead-free.
 3. Halogen- and Antimony-free "Green" products are defined as those which contain <900ppm bromine, <900ppm chlorine (<1500ppm total Br + Cl) and <1000ppm antimony compounds.
 4. For packaging details, go to our website at <http://www.diodes.com>.

Marking Information

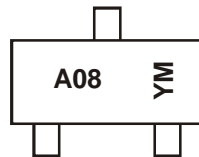

A08 = Product Type Marking Code
 YM = Date Code Marking
 Y = Year (ex: Z = 2012)
 M = Month (ex: 9 = September)

Date Code Key

Year	2011	2012	2013	2014	2015	2016	2017
Code	Y	Z	A	B	C	D	E

Month	Jan	Feb	Mar	Apr	May	Jun	Jul	Aug	Sep	Oct	Nov	Dec
Code	1	2	3	4	5	6	7	8	9	O	N	D

Maximum Ratings (@T_A = +25°C, unless otherwise specified.)

Characteristic	Symbol	Value	Unit	Conditions
Operating Supply Voltage	V _P - V _N	6.0	V	—
DC Voltage at any Channel Input	-	(V _N - 0.5) to (V _P + 0.5)	V	—
Peak Pulse Current	I _{PP}	5	A	8/20μs, Per Figure 3
ESD Protection – Contact Discharge	V _{ESD_Contact}	±8	kV	Standard IEC 61000-4-2
ESD Protection – Air Discharge	V _{ESD_Air}	±15	kV	Standard IEC 61000-4-2

Thermal Characteristics

Characteristic	Symbol	Value	Unit
Power Dissipation (Note 5)	P _D	300	mW
Thermal Resistance, Junction to Ambient (Note 5)	R _{θJA}	417	°C/W
Operating and Storage Temperature Range	T _J , T _{STG}	-65 to +150	°C

Electrical Characteristics (@T_A = +25°C, unless otherwise specified.)

Characteristic	Symbol	Min	Typ	Max	Unit	Test Conditions
Operating Supply Voltage	V _P	—	3.3	5.5	V	-
Operating Supply Current (Note 6)	I _P	—	—	8.0	μA	(V _P - V _N) = 3.3V
Channel Leakage Current (Note 6)	I _R	—	±0.1	±1.0	μA	V _P = 5V, V _N = 0V
Reverse breakdown voltage	V _{BR}	6.0	—	—	V	I _R = 1mA
Clamping Voltage, Positive Transients	V _{CL1}	—	10.0	—	V	I _{PP} = 1A, t _p = 8/20μs
Clamping Voltage, Negative Transients	V _{CL2}	—	-1.7	—	V	I _{PP} = -1A, t _p = 8/20μs
Forward Voltage for Top Diode	V _{FD1}	0.60	0.80	0.95	V	I _F = 8mA, CH1 to V _P
Forward Voltage for Bottom Diode	V _{FD2}	0.60	0.80	0.95	V	I _F = 8mA, V _N to CH1
Dynamic Resistance	R _{DYN}	—	0.9	—	Ω	I _{PP} = 1A, t _p = 8/20μs
Channel Input Capacitance	C _T	—	0.85	1.2	pF	V _{IN} = 1.65V, V _P = 3.3V, V _N = 0V, f = 1MHz

- Notes:
5. Device mounted on FR-4 PCB pad layout (2oz copper) as shown on Diodes, Inc. suggested pad layout AP02001, which can be found on our website at <http://www.diodes.com>.
 6. Short duration pulse test used to minimize self-heating effect.
 7. Measured from CH1 to V_N.
 8. Measured from V_P to V_N.
 9. For information on the impact of Diodes' USB 2.0 compatible ESD protectors on signal integrity including eye diagram plots, please refer to AN77 at the following URL: http://www.diodes.com/destdtools/appnote_dnote.html.

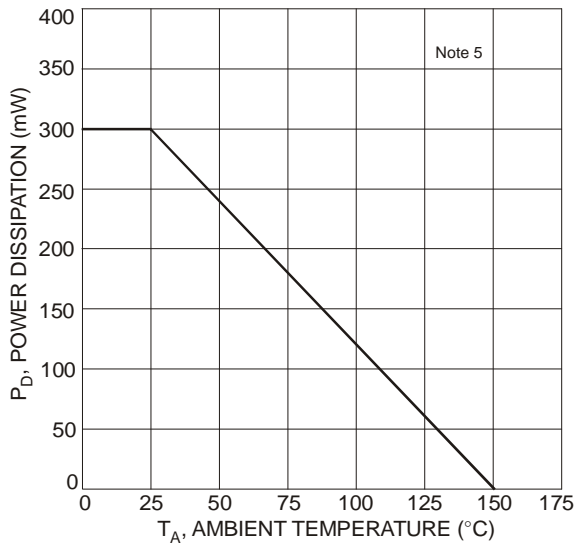

Figure 1 Power Derating Curve

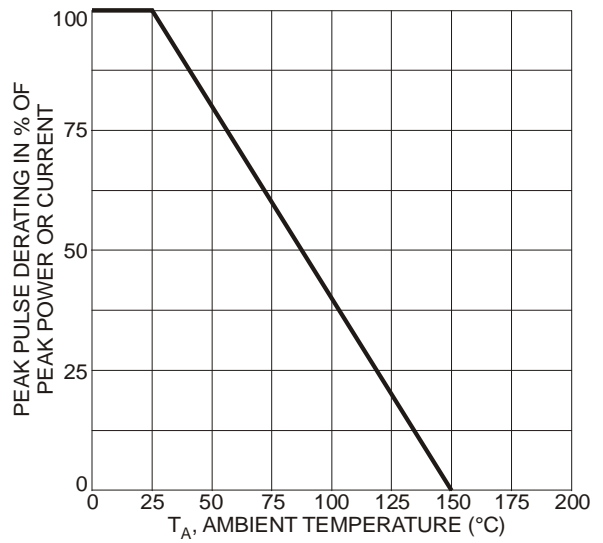

Figure 2 Pulse Derating Curve

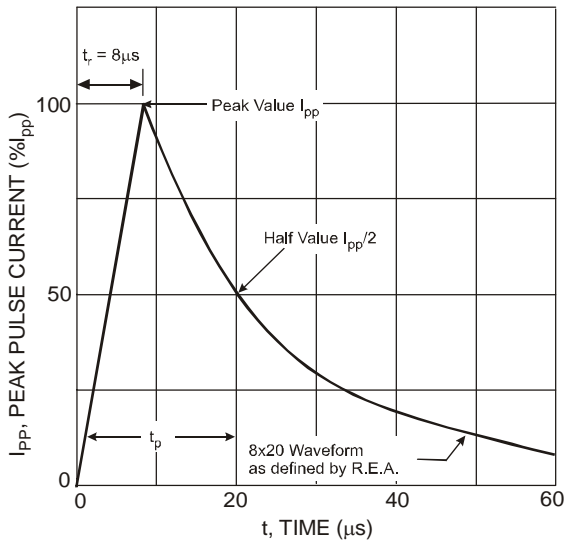

Figure 3 Typical 8 x 20µs Pulse Waveform

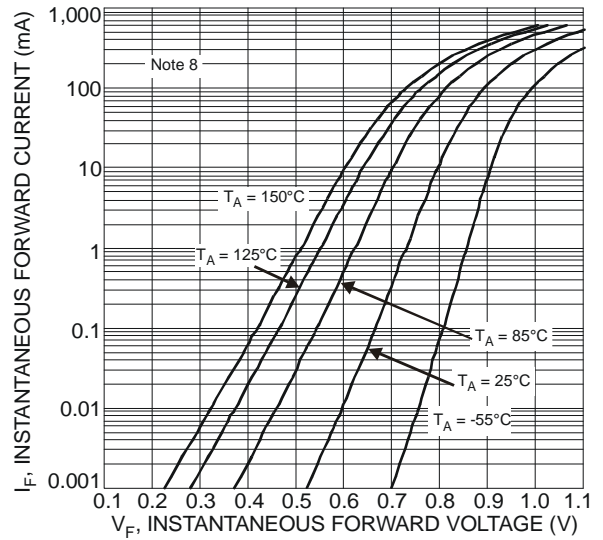

Figure 4 Typical Forward Characteristics

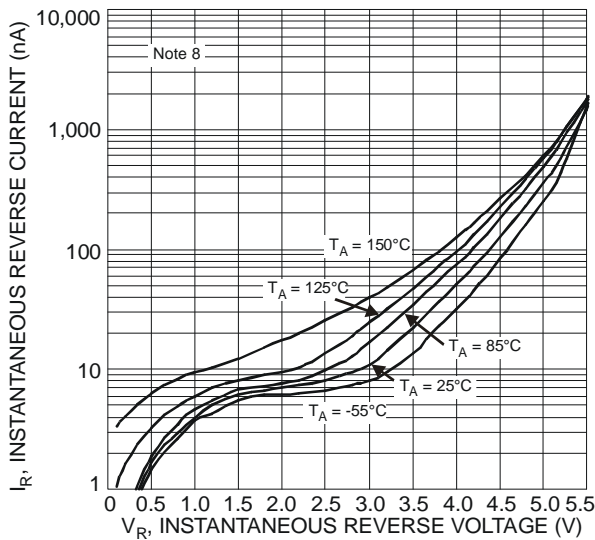

Figure 5 Typical Reverse Characteristics

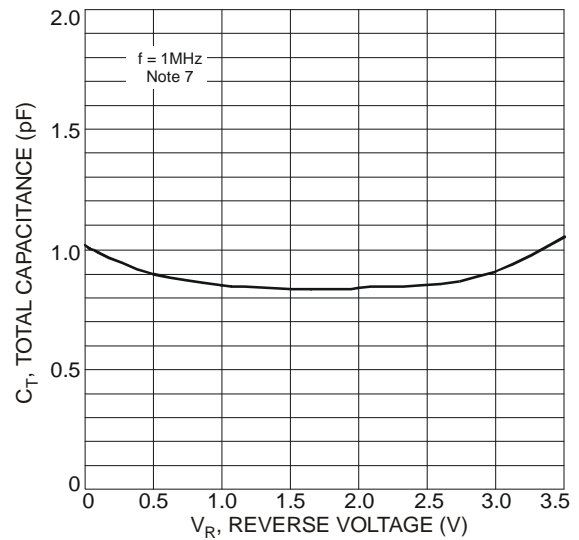
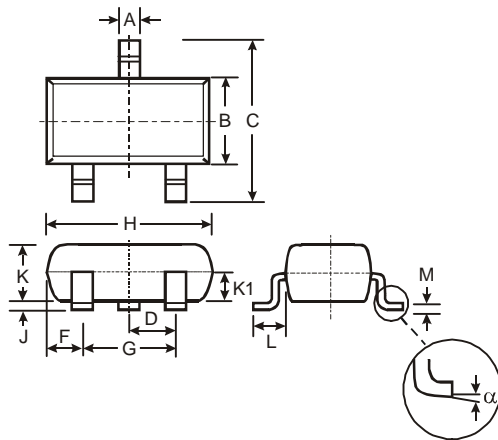

Figure 6 Typical Total Capacitance vs. Reverse Voltage

Package Outline Dimensions

Please see AP02002 at <http://www.diodes.com/datasheets/ap02002.pdf> for latest version.



SOT23			
Dim	Min	Max	Typ
A	0.37	0.51	0.40
B	1.20	1.40	1.30
C	2.30	2.50	2.40
D	0.89	1.03	0.915
F	0.45	0.60	0.535
G	1.78	2.05	1.83
H	2.80	3.00	2.90
J	0.013	0.10	0.05
K	0.903	1.10	1.00
K1	-	-	0.400
L	0.45	0.61	0.55
M	0.085	0.18	0.11
α	0°	8°	-
All Dimensions in mm			

Suggested Pad Layout

Please see AP02001 at <http://www.diodes.com/datasheets/ap02001.pdf> for the latest version.

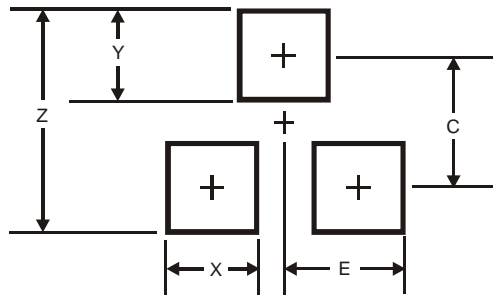

Dimensions	Value (in mm)
Z	2.9
X	0.8
Y	0.9
C	2.0
E	1.35

IMPORTANT NOTICE

DIODES INCORPORATED MAKES NO WARRANTY OF ANY KIND, EXPRESS OR IMPLIED, WITH REGARDS TO THIS DOCUMENT, INCLUDING, BUT NOT LIMITED TO, THE IMPLIED WARRANTIES OF MERCHANTABILITY AND FITNESS FOR A PARTICULAR PURPOSE (AND THEIR EQUIVALENTS UNDER THE LAWS OF ANY JURISDICTION).

Diodes Incorporated and its subsidiaries reserve the right to make modifications, enhancements, improvements, corrections or other changes without further notice to this document and any product described herein. Diodes Incorporated does not assume any liability arising out of the application or use of this document or any product described herein; neither does Diodes Incorporated convey any license under its patent or trademark rights, nor the rights of others. Any Customer or user of this document or products described herein in such applications shall assume all risks of such use and will agree to hold Diodes Incorporated and all the companies whose products are represented on Diodes Incorporated website, harmless against all damages.

Diodes Incorporated does not warrant or accept any liability whatsoever in respect of any products purchased through unauthorized sales channel. Should Customers purchase or use Diodes Incorporated products for any unintended or unauthorized application, Customers shall indemnify and hold Diodes Incorporated and its representatives harmless against all claims, damages, expenses, and attorney fees arising out of, directly or indirectly, any claim of personal injury or death associated with such unintended or unauthorized application.

Products described herein may be covered by one or more United States, international or foreign patents pending. Product names and markings noted herein may also be covered by one or more United States, international or foreign trademarks.

This document is written in English but may be translated into multiple languages for reference. Only the English version of this document is the final and determinative format released by Diodes Incorporated.

LIFE SUPPORT

Diodes Incorporated products are specifically not authorized for use as critical components in life support devices or systems without the express written approval of the Chief Executive Officer of Diodes Incorporated. As used herein:

A. Life support devices or systems are devices or systems which:

1. are intended to implant into the body, or
2. support or sustain life and whose failure to perform when properly used in accordance with instructions for use provided in the labeling can be reasonably expected to result in significant injury to the user.

B. A critical component is any component in a life support device or system whose failure to perform can be reasonably expected to cause the failure of the life support device or to affect its safety or effectiveness.

Customers represent that they have all necessary expertise in the safety and regulatory ramifications of their life support devices or systems, and acknowledge and agree that they are solely responsible for all legal, regulatory and safety-related requirements concerning their products and any use of Diodes Incorporated products in such safety-critical, life support devices or systems, notwithstanding any devices- or systems-related information or support that may be provided by Diodes Incorporated. Further, Customers must fully indemnify Diodes Incorporated and its representatives against any damages arising out of the use of Diodes Incorporated products in such safety-critical, life support devices or systems.

Copyright © 2012, Diodes Incorporated

www.diodes.com