

BAR64-03W

Single RF PIN diode

-  Order now
-  Technical documents
-  Simulation
-  Support

Product description

This Infineon RF PIN diode provides high-voltage handling capabilities, comes with low loss and offers low distortion levels. Its low forward resistance, low capacitance and low inductance simplify design-in and support designers in creating versatile end-solutions.



Feature list

- Very low capacitance $C = 0.2 \text{ pF}$ (typical) at voltage $V_R = 0 \text{ V}$ and frequencies $f \geq 1 \text{ GHz}$
- Low forward resistance $R_F = 3.1 \text{ } \Omega$ (typical) at forward current $I_F = 10 \text{ mA}$ and frequency $f = 1 \text{ GHz}$
- Low signal distortion
- Industry standard SOD323 package (2.5 mm x 1.25 mm x 0.9 mm)
- Pb-free, RoHS compliant and halogen-free

Product validation

Qualified for industrial applications according to the relevant tests of JEDEC47/20/22.

Potential applications

Optimized for low bias current RF and high-speed interface switches in:

- Wireless communications
- High speed data networks

Device information

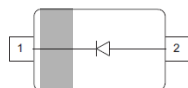

Table 1 Part information

Product name / Ordering code	Package	Configuration	Marking	Pieces / Reel
BAR64-03W / BAR6403WE6327HTSA1	SOD323	Single, with leads	blue 2	3 k

Attention: *ESD (Electrostatic discharge) sensitive device, observe handling precautions!*

Table of contents

Product description 1

Feature list 1

Product validation 1

Potential applications 1

Device information 1

Table of contents 2

1 Absolute maximum ratings 2

2 Electrical performance in test fixture 3

2.1 DC characteristics 3

2.2 AC characteristics 4

3 Thermal characteristics 9

4 Package information SOD323 11

Revision history 12

Disclaimer 13

1 Absolute maximum ratings

Table 2 Absolute maximum ratings at $T_A = 25\text{ °C}$, unless otherwise specified

Parameter	Symbol	Values		Unit	Note or test condition
		Min.	Max.		
Diode reverse voltage	V_R	-	150	V	
Forward current	I_F	-	100	mA	
Total power dissipation	P_{TOT}	-	250	mW	$T_S \leq 112\text{ °C}$ ¹⁾
Junction temperature	T_J	-	150	°C	
Operating temperature	T_{OP}	-55	125		
Storage temperature	T_{STG}	-55	150		

Attention: Stresses above the maximum values listed here may cause permanent damage to the device. Exposure to absolute maximum rating conditions for extended periods may affect device reliability. Exceeding only one of these values may cause irreversible damage to the component.

¹ T_S is the soldering point temperature.

Electrical performance in test fixture

2 Electrical performance in test fixture

2.1 DC characteristics

At $T_A = 25\text{ }^\circ\text{C}$, unless otherwise specified

Table 3 DC characteristics

Parameter	Symbol	Values			Unit	Note or test condition
		Min.	Typ.	Max.		
Breakdown voltage	V_{BR}	150	–	–	V	$I_R = 5\text{ }\mu\text{A}$
Reverse current	I_R	–	–	20	nA	$V_R = 20\text{ V}$
Forward voltage	V_F	–	0.82	–	V	$I_F = 10\text{ mA}$
		–	0.9	–		$I_F = 50\text{ mA}$
		–	0.95	1.1		$I_F = 100\text{ mA}$
I-region width	W_I	–	50	–	μm	

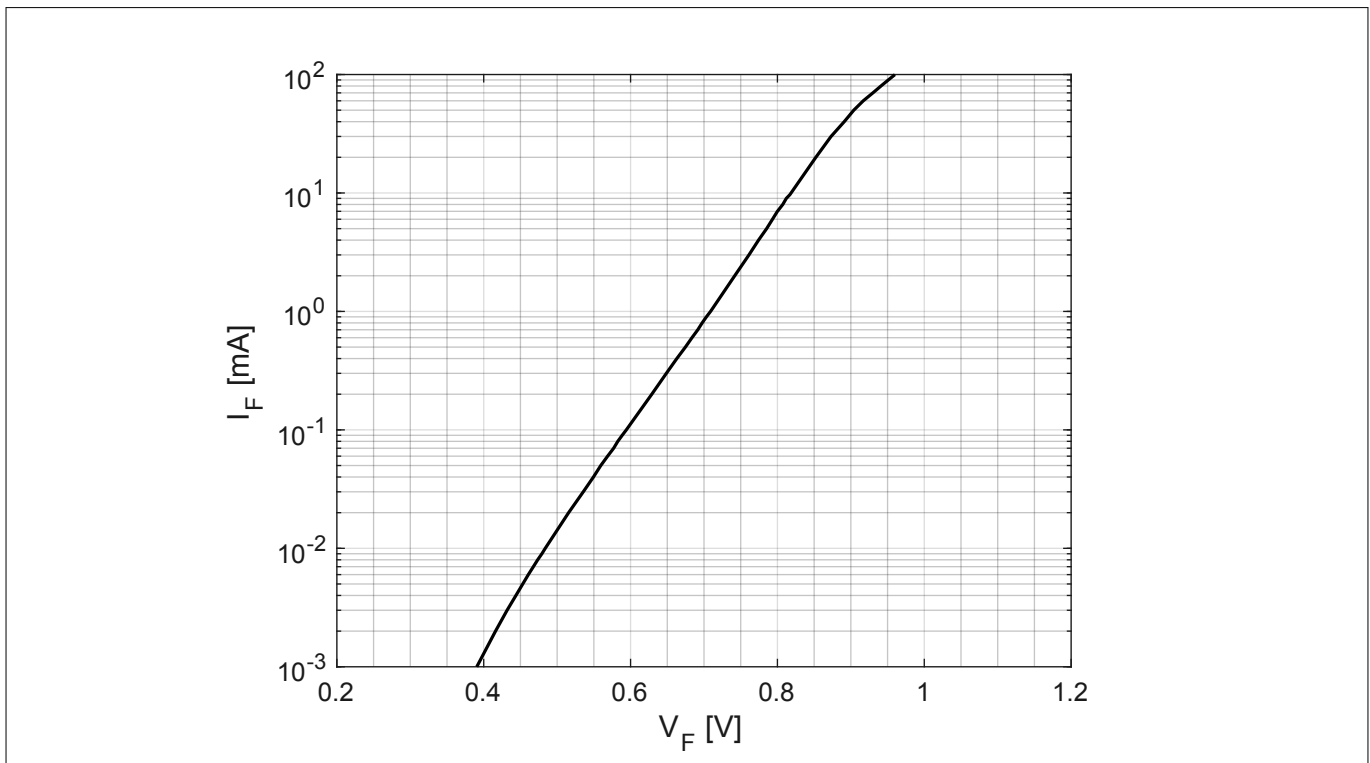

Figure 1 Forward current I_F vs. forward voltage V_F

Electrical performance in test fixture

2.2 AC characteristics

At $T_A = 25\text{ °C}$, unless otherwise specified

Table 4 Key parameter

Parameter	Symbol	Values			Unit	Note or test condition
		Min.	Typ.	Max.		
Capacitance	C	–	0.61	–	pF	$V_R = 0\text{ V}, f = 1\text{ MHz}$
		–	0.23	0.35		$V_R = 20\text{ V}, f = 1\text{ MHz}$
Forward resistance	R_F	–	11.1	20		$I_F = 1\text{ mA}, f = 100\text{ MHz}$
		–	5	–		$I_F = 3\text{ mA}, f = 100\text{ MHz}$
		–	3.8	–		$I_F = 5\text{ mA}, f = 100\text{ MHz}$
		–	2.7	2.8		$I_F = 10\text{ mA}, f = 100\text{ MHz}$
		–	–	1.35		$I_F = 100\text{ mA}, f = 100\text{ MHz}$
Inductance	L_S	–	1.8	–	nH	
Charge carrier lifetime	τ_{rr}	–	1550	–	ns	$I_F = 10\text{ mA}, I_R = 6\text{ mA}$, measured at $I_R = 3\text{ mA}$, $R_L = 100\ \Omega$

Table 5 AC parameter at $f = 1\text{ GHz}$

Parameter	Symbol	Values			Unit	Note or test condition
		Min.	Typ.	Max.		
Capacitance	C	–	0.2	–	pF	$V_R = 0\text{ V}$
Reverse parallel resistance	R_P	–	3.4	–	k Ω	$V_R = 0\text{ V}$
Forward resistance	R_F	–	10.8	–	Ω	$I_F = 1\text{ mA}$
		–	5.2	–		$I_F = 3\text{ mA}$
		–	4	–		$I_F = 5\text{ mA}$
		–	3.1	–		$I_F = 10\text{ mA}$
Insertion loss	I_L	–	0.88	–	dB	$I_F = 1\text{ mA}$
		–	0.45	–		$I_F = 3\text{ mA}$
		–	0.35	–		$I_F = 5\text{ mA}$
		–	0.27	–		$I_F = 10\text{ mA}$
Isolation	I_{SO}	–	20.4	–		$V_R = 0\text{ V}$

Table 6 AC parameter at $f = 1.8\text{ GHz}$

Parameter	Symbol	Values			Unit	Note or test condition
		Min.	Typ.	Max.		
Capacitance	C	–	0.2	–	pF	$V_R = 0\text{ V}$
Reverse parallel resistance	R_P	–	2.7	–	k Ω	$V_R = 0\text{ V}$

Electrical performance in test fixture

Table 6 AC parameter at $f = 1.8$ GHz (continued)

Parameter	Symbol	Values			Unit	Note or test condition
		Min.	Typ.	Max.		
Forward resistance	R_F	-	11	-	Ω	$I_F = 1$ mA
		-	5.3	-		$I_F = 3$ mA
		-	4.2	-		$I_F = 5$ mA
		-	3.2	-		$I_F = 10$ mA
Insertion loss	I_L	-	0.94	-	dB	$I_F = 1$ mA
		-	0.51	-		$I_F = 3$ mA
		-	0.42	-		$I_F = 5$ mA
		-	0.34	-		$I_F = 10$ mA
Isolation	I_{SO}	-	15.7	-		$V_R = 0$ V

Table 7 AC parameter at $f = 2.5$ GHz

Parameter	Symbol	Values			Unit	Note or test condition
		Min.	Typ.	Max.		
Capacitance	C	-	0.2	-	pF	$V_R = 0$ V
Reverse parallel resistance	R_P	-	2.4	-	k Ω	$V_R = 0$ V
Forward resistance	R_F	-	11.2	-	Ω	$I_F = 1$ mA
		-	5.6	-		$I_F = 3$ mA
		-	4.4	-		$I_F = 5$ mA
		-	3.4	-		$I_F = 10$ mA
Insertion loss	I_L	-	1	-	dB	$I_F = 1$ mA
		-	0.59	-		$I_F = 3$ mA
		-	0.5	-		$I_F = 5$ mA
		-	0.43	-		$I_F = 10$ mA
Isolation	I_{SO}	-	13	-		$V_R = 0$ V

Electrical performance in test fixture

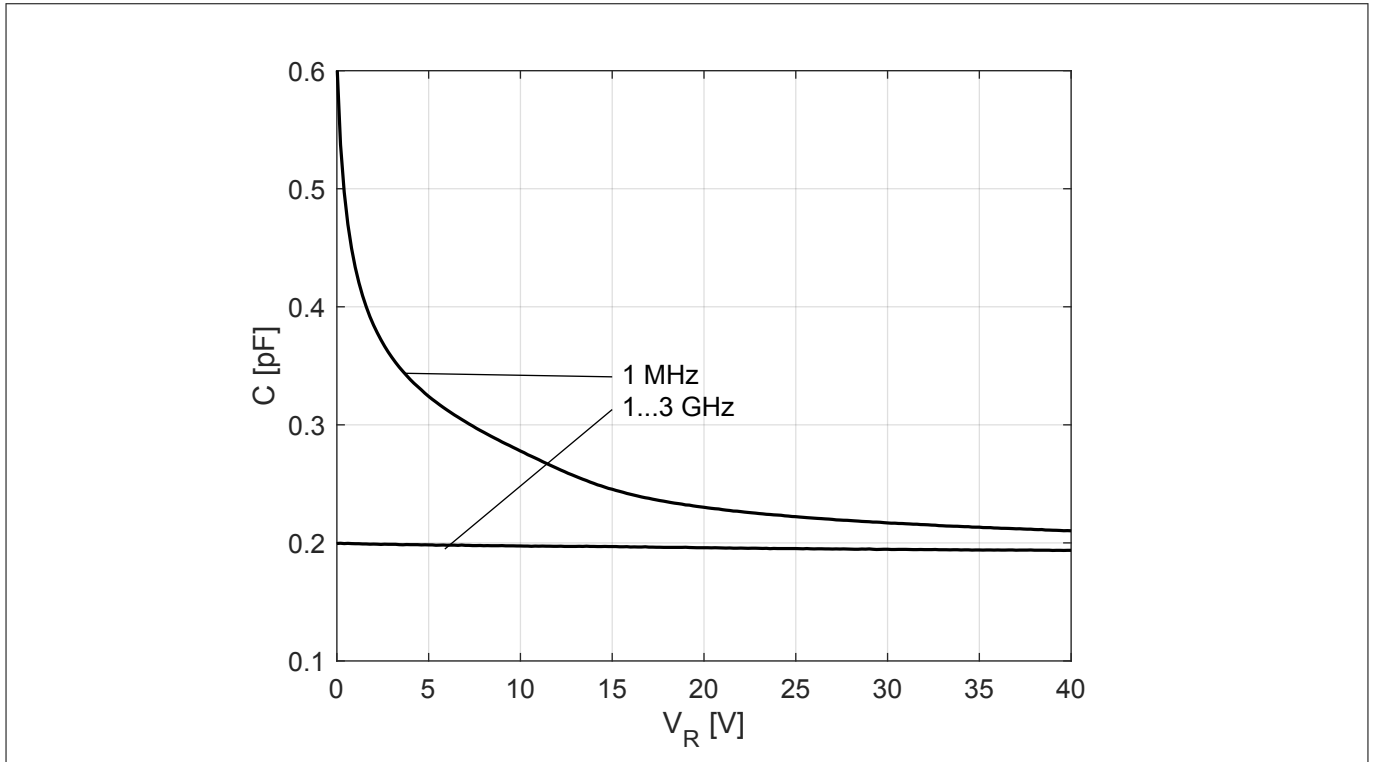

Figure 2 Capacitance C vs. reverse voltage V_R at different frequencies

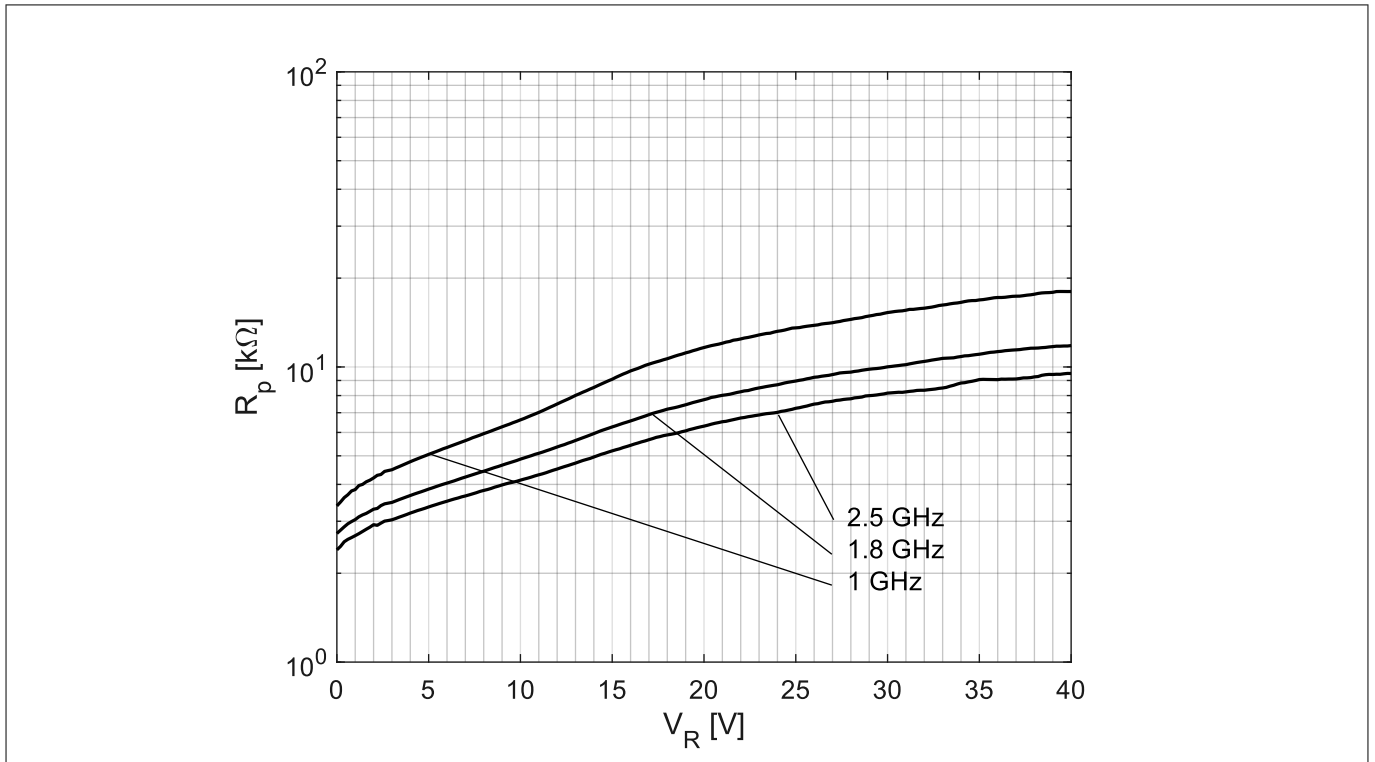

Figure 3 Reverse parallel resistance R_p vs. reverse voltage V_R at different frequencies

Electrical performance in test fixture

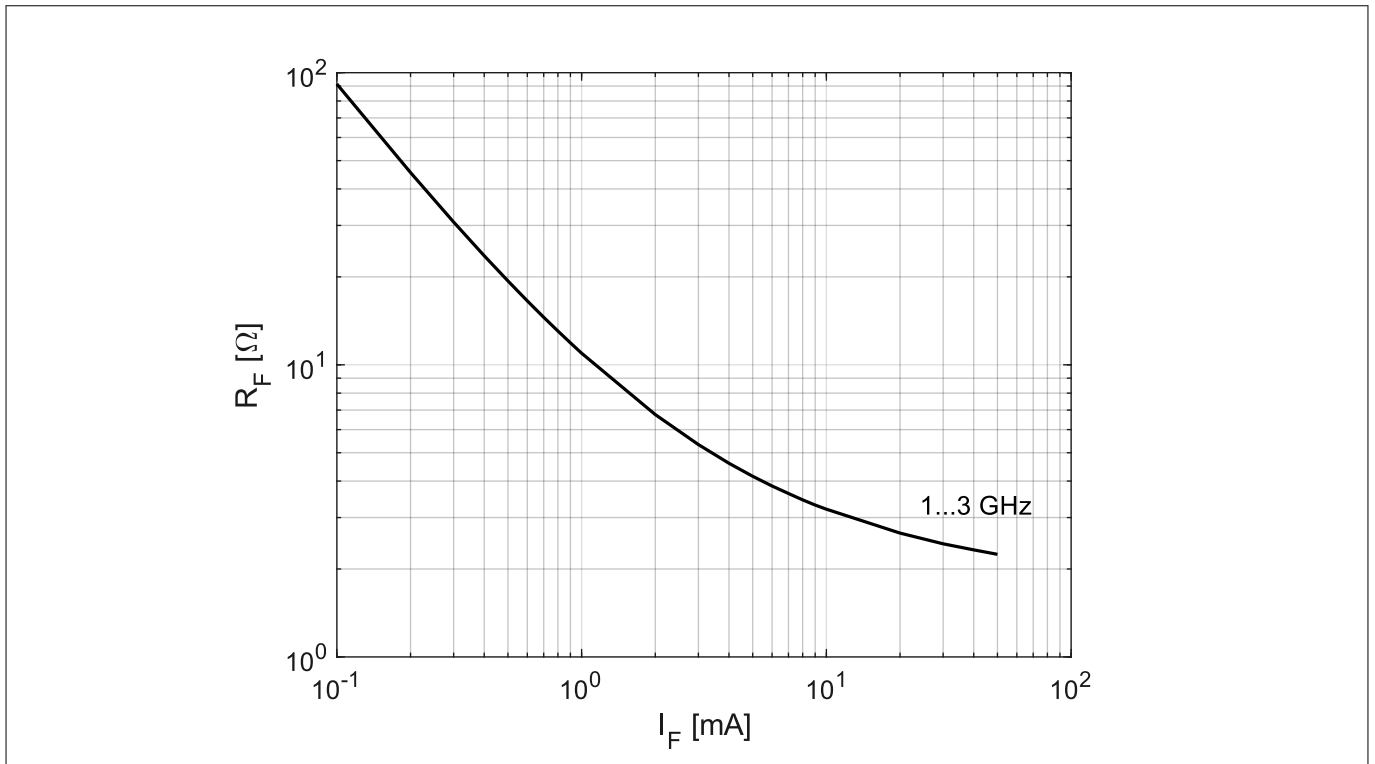

Figure 4 Forward resistance R_F vs. forward current I_F at different frequencies

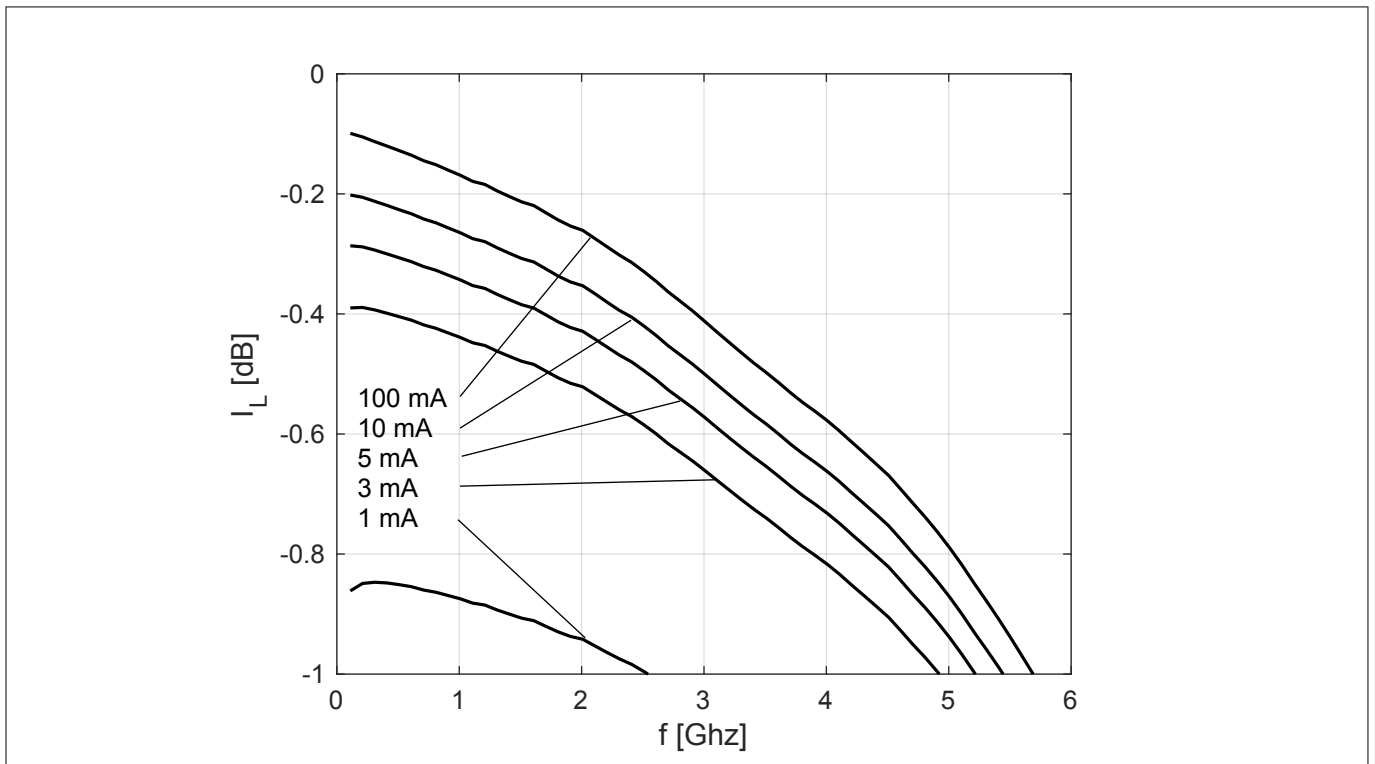

Figure 5 Insertion loss I_L vs. frequency f at different forward currents

Electrical performance in test fixture

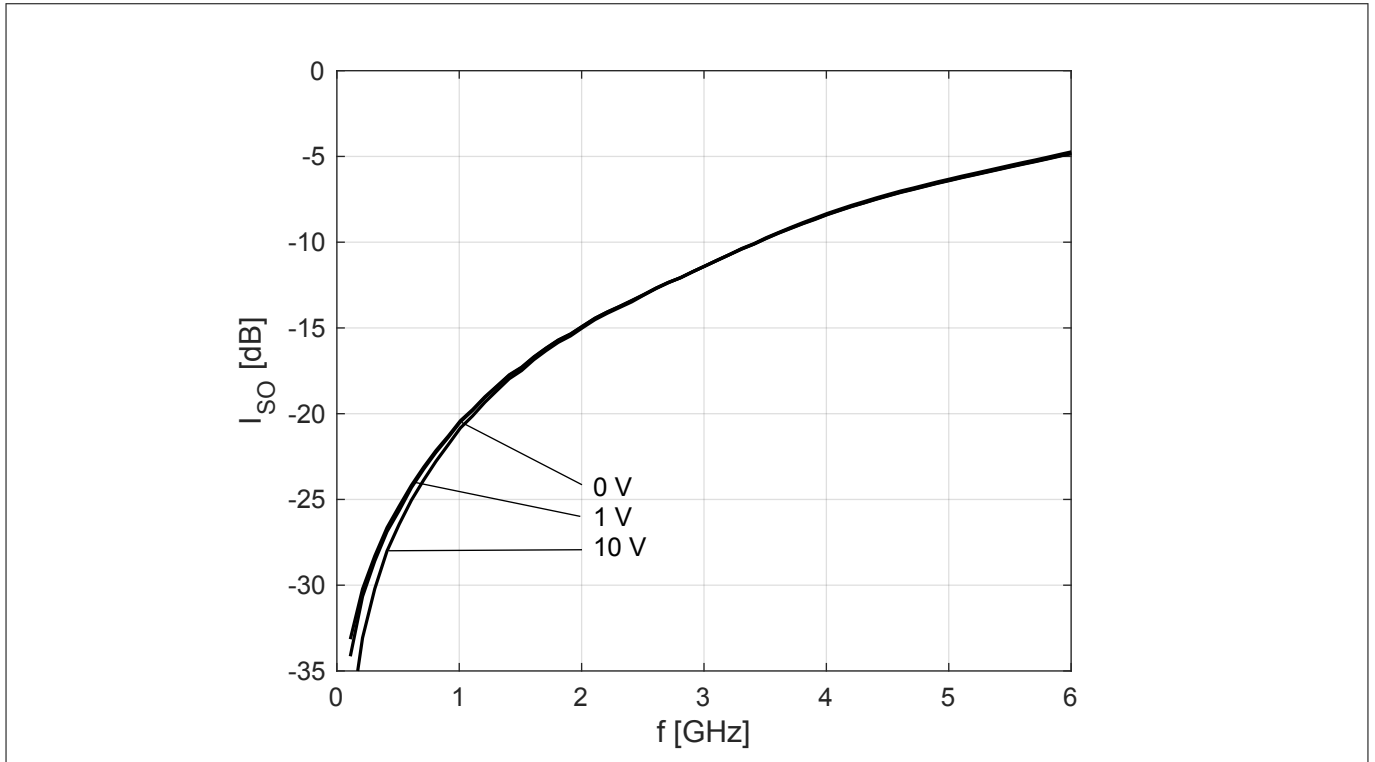

Figure 6 Isolation I_{50} vs. frequency f at different reverse voltages

Note: The curves shown in this chapter have been generated using typical devices but shall not be understood as a guarantee that all devices have identical characteristic curves.

Thermal characteristics

3 Thermal characteristics

Table 8 Thermal resistance

Parameter	Symbol	Values			Unit	Note or test condition
		Min.	Typ.	Max.		
Thermal resistance (junction - soldering point)	R_{thJS}	-	150	-	K/W	$T_S = 112\text{ °C}$ ¹⁾

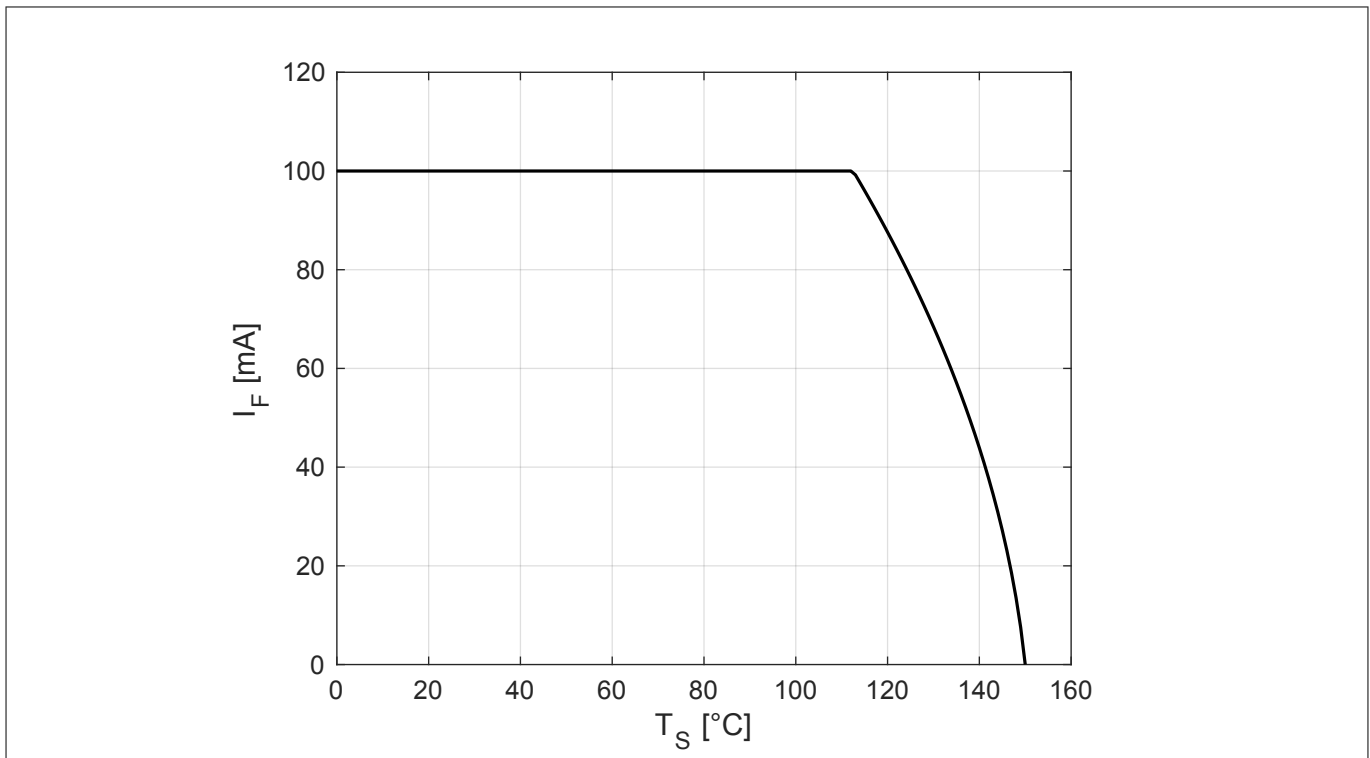

Figure 7 Permissible forward current I_F in DC operation

¹ For R_{thJS} in other conditions refer to the curves in this chapter.

Thermal characteristics

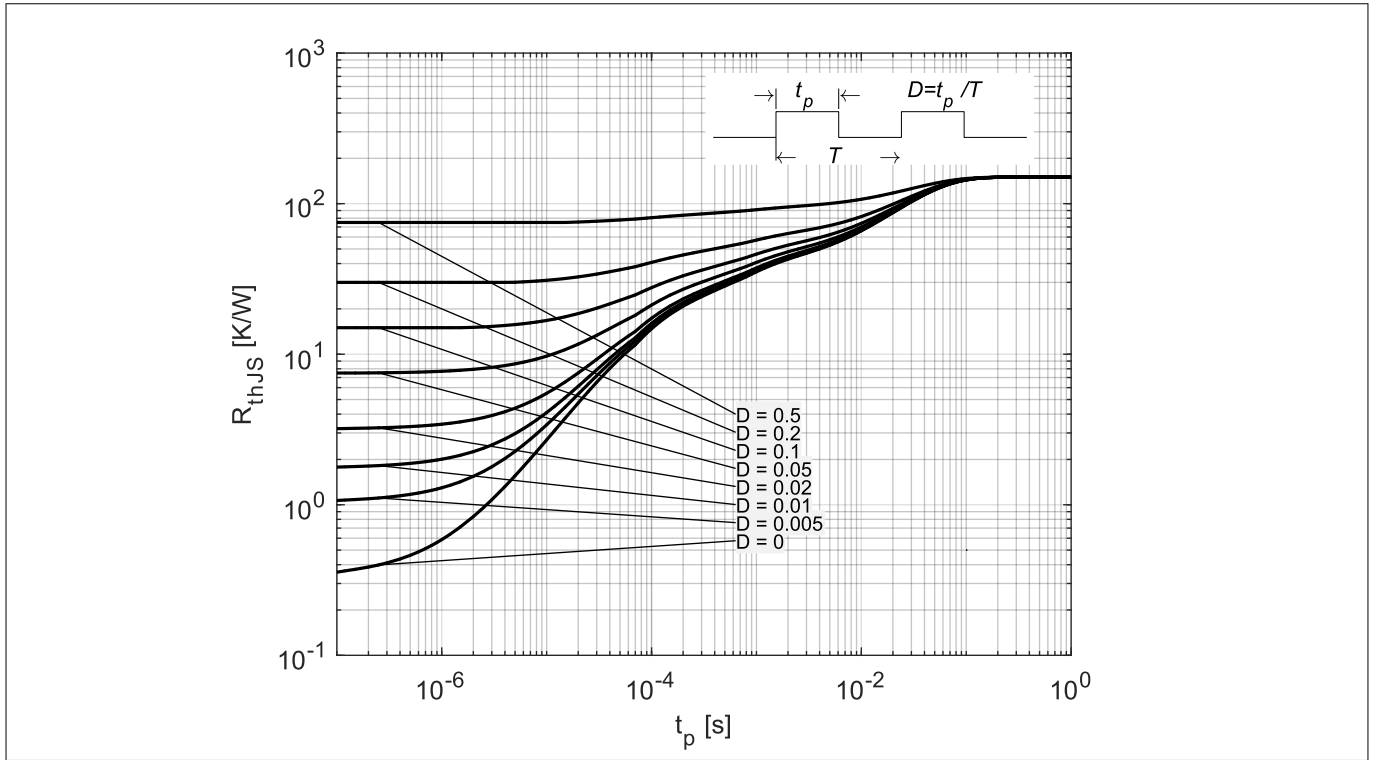

Figure 8 Thermal resistance R_{thJS} in pulse operation

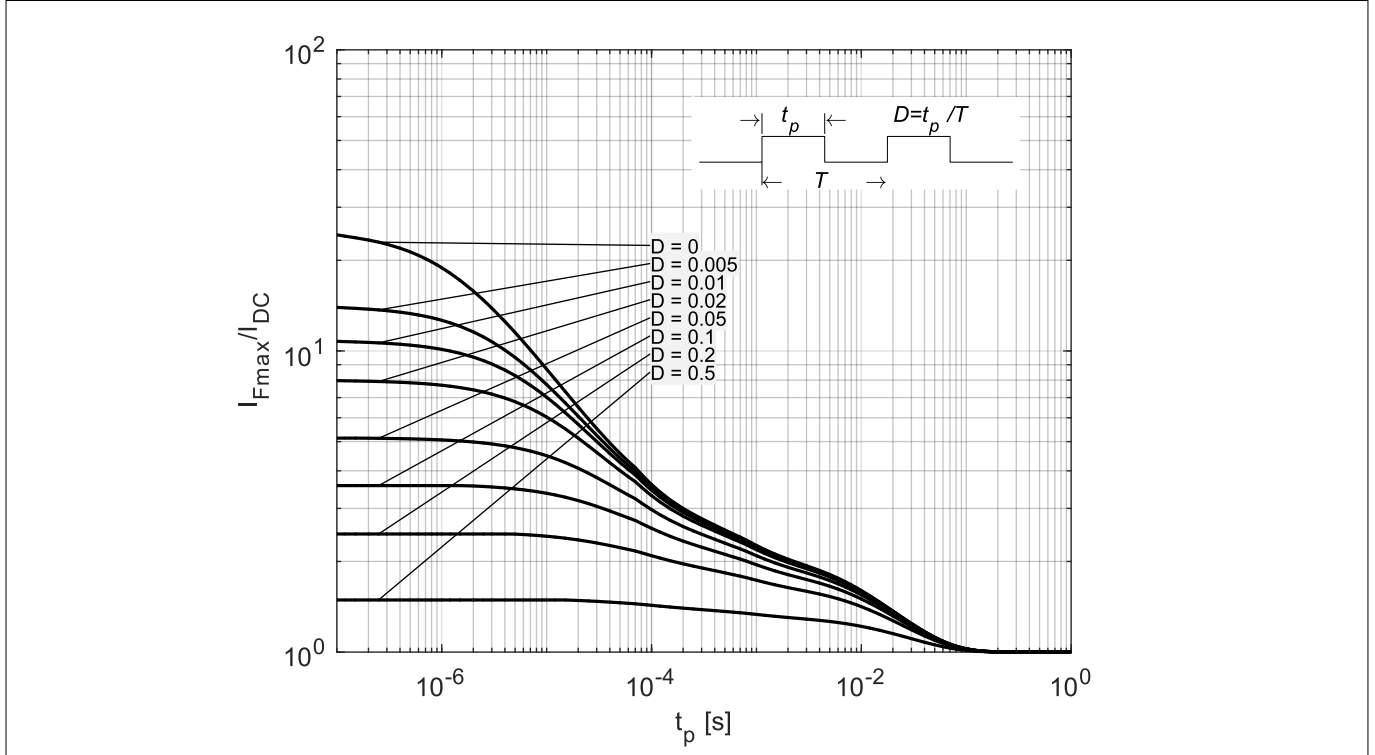

Figure 9 Permissible forward current ratio I_{Fmax}/I_{DC} in pulse operation

Package information SOD323

4 Package information SOD323

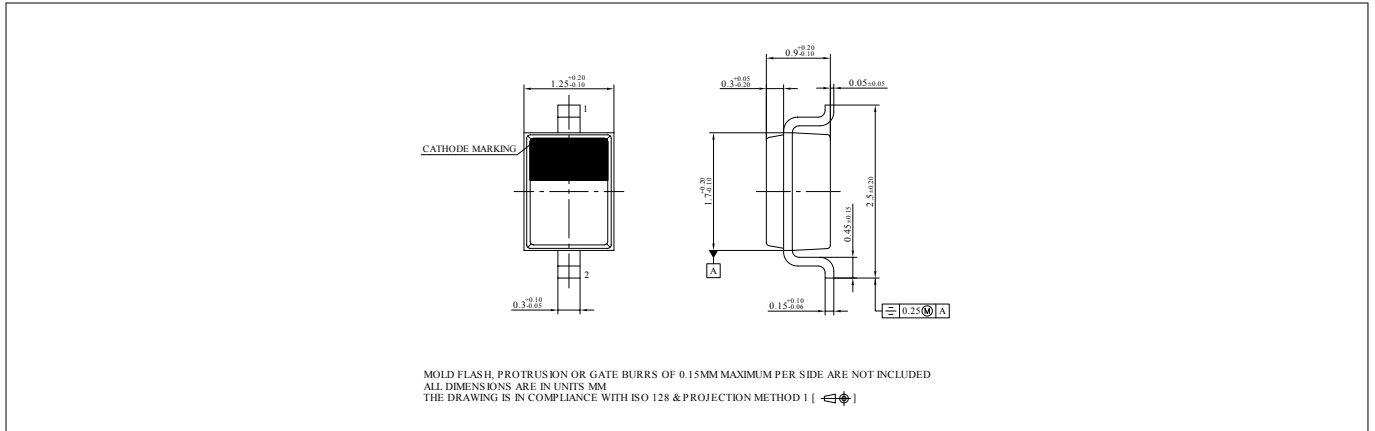

Figure 10 Package outline

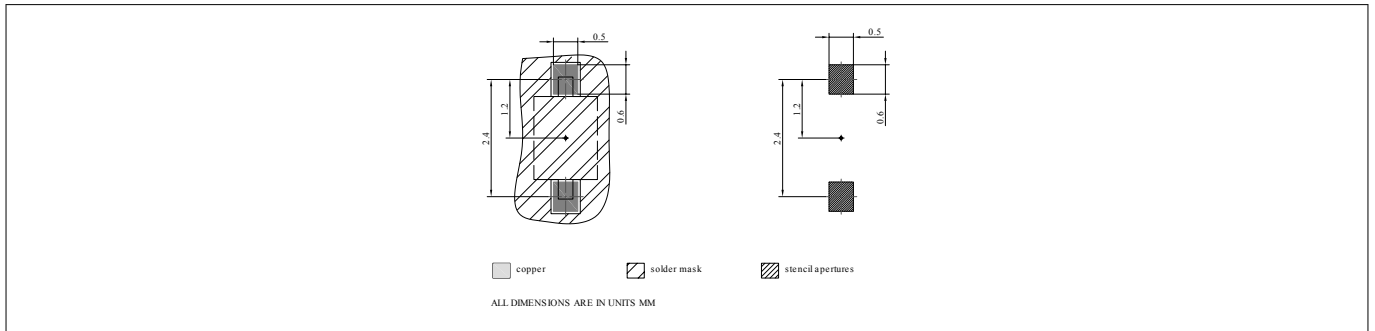

Figure 11 Foot print

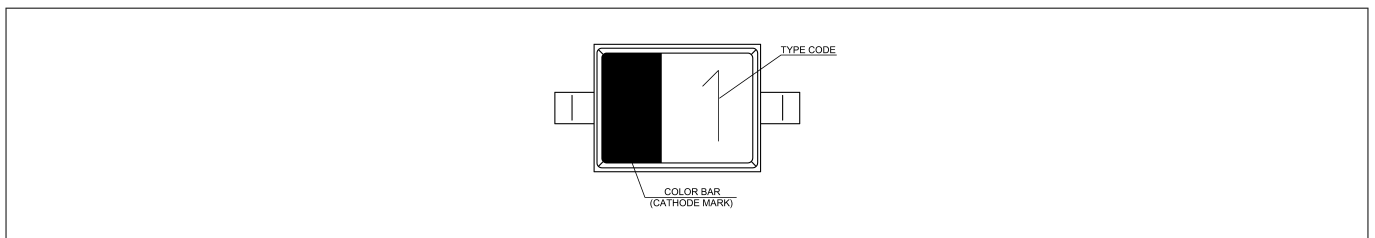

Figure 12 Marking layout example

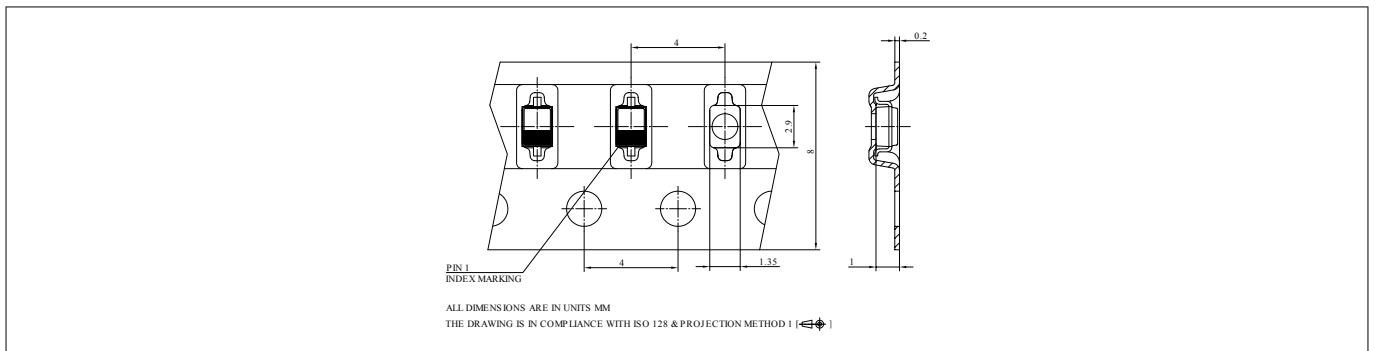

Figure 13 Tape dimensions

Revision history

Revision history

Document version	Date of release	Description of changes
1.0	2018-09-07	<ul style="list-style-type: none">• Change from series datasheet to individual one• Initial release of datasheet• Typical values and curves updated to the values of the production (No product or process change behind)• Maximum/typical values added• Typical curves/values removed

Trademarks

All referenced product or service names and trademarks are the property of their respective owners.

Edition 2018-06-30

Published by
Infineon Technologies AG
81726 Munich, Germany

© 2018 Infineon Technologies AG
All Rights Reserved.

Do you have a question about any aspect of this document?
Email: erratum@infineon.com

Document reference
IFX-siy1535443387081

IMPORTANT NOTICE

The information given in this document shall in no event be regarded as a guarantee of conditions or characteristics ("Beschaffheitsgarantie").

With respect to any examples, hints or any typical values stated herein and/or any information regarding the application of the product, Infineon Technologies hereby disclaims any and all warranties and liabilities of any kind, including without limitation warranties of non-infringement of intellectual property rights of any third party.

In addition, any information given in this document is subject to customer's compliance with its obligations stated in this document and any applicable legal requirements, norms and standards concerning customer's products and any use of the product of Infineon Technologies in customer's applications.

The data contained in this document is exclusively intended for technically trained staff. It is the responsibility of customer's technical departments to evaluate the suitability of the product for the intended application and the completeness of the product information given in this document with respect to such application.

WARNINGS

Due to technical requirements products may contain dangerous substances. For information on the types in question please contact your nearest Infineon Technologies office.

Except as otherwise explicitly approved by Infineon Technologies in a written document signed by authorized representatives of Infineon Technologies, Infineon Technologies' products may not be used in any applications where a failure of the product or any consequences of the use thereof can reasonably be expected to result in personal injury