

Key data

1x 900A rms at 400V rms, water cooled

General information

Stacks for various inverter application. Semiconductors, heat sinks, drivers and sensors included. These are only technical data!

Please read carefully the complete documentation and maintain the proper design environment! Especially note the EMC environment and the controller's functionality.

Topology	1/2 B2I	
Application / Modulation	Inverter / Sine	
Load type	resistive, inductive	
Cooling	water cooled	
Implemented sensors	current, voltage, temperature	
Semicond. (Unit 1)	none	
DC Link	none	
Semicond. (Unit 2)	IGBT	3x FF450R12KE4
Driver signals IGBT	electrical CMOS 0 .. 15V	
Standards	EN50178, UL94, prepared for UL508C	
Sales - name	2PS13512E43W35222	
Internal ID	35222	
Mechanical drawing number	34482_MB	
Electrical drawing number	2PS-C3-V	

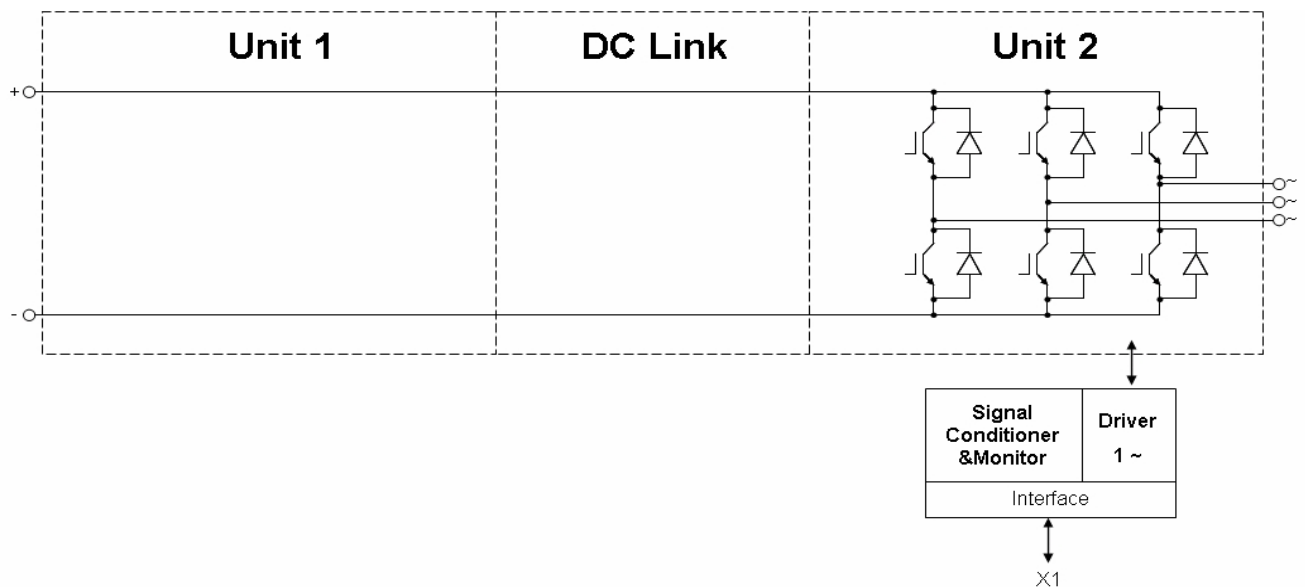
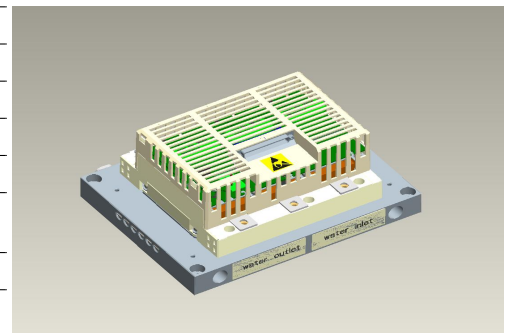

prepared by: OW	date of publication: 2014-03-17
approved by: KV	revision: 2.3

Technical Information

PrimeSTACK™

2PS13512E43W35222



Preliminary data

Note

The inverter current is limited by the current sensor.
 Heat sink with aluminum cooling channel.
 Composites of fluid: Water and 52 vol. % Antifrogen N.
 Alignment over temperature shutdown for water inlet temperatures up to 70Ω°C.

Electrical data

DC Link

			min	typ	max	units
Voltage		V_{DC}		650	850	V
Oversvoltage shutdown	within 600μs			850		V

Unit 2 AC

			min	typ	max	units
Voltage	depending on controller	V_{Unit2}		400		V_{RMS}
Continuous current	$V_{Unit2} = 400V_{RMS}$, $V_{DC} = 650V$, $T_{inlet} = 40^{\circ}C$, $T_J \leq 125^{\circ}C$, $f_{Unit2} = 50Hz$, $f_{sw2} = 5000Hz$, $\cos(\phi) = 0,85$	I_{Unit2}			900	A_{RMS}
Continuous current overload cap.	$T_{inlet} = 40^{\circ}C$, for overload capability 150% for 60s			727		A_{RMS}
DC current	no rotating field, $T_{inlet} = 40^{\circ}C$	$I_{Unit2 DC}$			547,0	A_{av}
Overcurrent shutdown	within 15μs			1860		A_{peak}
Switching frequency		f_{sw2}			8000	Hz
Power losses	$V_{Unit2} = 400V$, $V_{DC} = 650V$, $T_{inlet} = 40^{\circ}C$, $T_J \leq 125^{\circ}C$, $f_{Unit2} = 50Hz$, $f_{sw2} = 5000Hz$, $\cos(\phi) = 0,85$, $I_{Unit2} = 900A_{RMS}$	P_{loss2}		2940		W
Power factor		$\cos(\phi)_{Unit2}$	-1,00		1,00	

General data

			min	typ	max	units
Power losses (PCB)		$P_{loss aux}$			40	W
EMC test	according to IEC61800-3 at named interfaces	power		V_{Burst}	2	kV
		control		V_{Burst}	1	kV
		aux (24V)		V_{Surge}	1	kV
Insulation management is designed for		V_{Line}		500		V_{RMS}
Insulation test voltage	according to EN50178, $f = 50Hz$, $t = 60s$	V_{isol}		2,5		kV_{RMS}

Controller interface data

			min	typ	max	units
Auxiliary voltage		V_{aux}	13	24	30	V_{av}
Auxiliary power requirement	$V_{aux} = 24V_{av}$	P_{aux}		40		W
Driver and interface board	see separate technical information			DR240		
Driver core				EiceDRIVER 2ED300C17-ST		
Digital input level	resistor to GND 10,0kΩ, capacitor to GND 1nF	V_{in}	0,0		15,0	V
Digital output level	open collector, low = ok, max 15mA	V_{out}	0,0		30,0	V
Analog current outputs Unit 2	load max 1mA; at 900A	$V_{ana out}$	4,80	4,90	5,00	V
Analog DC Link voltage output	load max 1mA; at 850V	$V_{DC out}$	8,33	8,50	8,67	V
Analog temperature output	load max 1mA; at $T_{NTC} = 55^{\circ}C$ correspond to $T_j = 125^{\circ}C$	$V_{T out}$	4,47	4,56	4,65	V
Overtemperature shutdown	at $T_{NTC} = 81^{\circ}C$	$V_{T out OT}$		10		V

prepared by: OW	date of publication: 2014-03-17
approved by: KV	revision: 2.3

Technical Information

PrimeSTACK™

2PS13512E43W35222



Preliminary data

Heat sink water cooled / Thermal data

			min	typ	max	units
Water flow	according cooling water specification from infineon	$\Delta V/\Delta t_{\text{Water}}$	10			dm ³ /min
Water pressure drop		Δp_{Water}		30		mbar
Water pressure					8	bar
Cooling water inlet temperature		T_{inlet}	-40		70	°C
Water connection				3/4		in

prepared by: OW	date of publication: 2014-03-17
approved by: KV	revision: 2.3

Technical Information

PrimeSTACK™

2PS13512E43W35222



Preliminary data

IGBT data unit 2

Type	assumed		min	typ	max	units
collector-emitter saturation voltage	$I_c = 450A; V_{ge} = 15V; T_{vj} = 150^\circ C$	$V_{CE\ sat}$		2,05		V
parameter for linear model	$T_{vj} = 25^\circ C$	V_{ce1}		0,922		V
parameter for linear model	$T_{vj} = 25^\circ C$	r_{ce1}		1,84		mΩ
parameter for linear model	$T_{vj} = 150^\circ C$	V_{ce2}		0,79		V
parameter for linear model	$T_{vj} = 150^\circ C$	r_{ce2}		2,8		mΩ
turn-on / turn-off energy loss per pulse	$T_{vj} = 25^\circ C$	E_1		19 / 33		mJ
turn-on / turn-off energy loss per pulse	$T_{vj} = 150^\circ C$	E_2		36 / 56		mJ
thermal resistance, junction to case	per IGBT	R_{thjc}		0,062		K/W
thermal resistance, case to heatsink	per IGBT	R_{thch}		0,031		K/W

Diode data unit 2

Type	assumed		min	typ	max	units
forward voltage	$I_F = 450A; V_{ge} = 0V; T_{vj} = 150^\circ C$	V_F		1,75		V
parameter for linear model	$T_{vj} = 25^\circ C$	V_{F1}		1,05		V
parameter for linear model	$T_{vj} = 25^\circ C$	r_{F1}		1,444		mΩ
parameter for linear model	$T_{vj} = 150^\circ C$	V_{F2}		0,833		V
parameter for linear model	$T_{vj} = 150^\circ C$	r_{F2}		2,037		mΩ
reverse recovery energy	$T_{vj} = 25^\circ C$	E_{rec1}		19		mJ
reverse recovery energy	$T_{vj} = 150^\circ C$	E_{rec2}		39		mJ
thermal resistance, junction to case	per Diode	R_{thjc}		0,11		K/W
thermal resistance, case to heatsink	per Diode	R_{thch}		0,055		K/W

prepared by: OW	date of publication: 2014-03-17
approved by: KV	revision: 2.3

Technical Information

PrimeSTACK™

2PS13512E43W35222



Preliminary data

Environmental conditions

			min	typ	max	units
Storage temperature		T_{stor}	-40		85	°C
Ambient temperature		T_{amb}	-25		55	°C
Operating temperature	see chapter Heat sink water cooled / Thermal data					
Cooling air velocity (PCB)		$V_{Air PCB}$	0,3			m/s
Air pressure	standard atmosphere	p_{Air}	900		1100	hPa
Humidity	no condensation	Rel. F	5		85	%
Installation height			0		1000	m
Vibration	according to IEC60721				5	m/s ²
Shock	according to IEC60721				40	m/s ²
Protection degree			IP00			
Pollution degree			2			
Torque at DC Terminals		M_{DC}	6,0		10,0	Nm
Torque at AC Terminals		M_{AC}	16,0		20,0	Nm
Dimensions	width × depth × height		260	280	120	mm
Weight with heat sink	approximation			7,7		kg
Weight without heat sink	approximation			2,9		kg

prepared by: OW	date of publication: 2014-03-17
approved by: KV	revision: 2.3



Preliminary data

fo - derating curve IGBT (motor), Diode (generator)
 cos(phi) = ± 0,85
 T_{cool medium} = 40°C

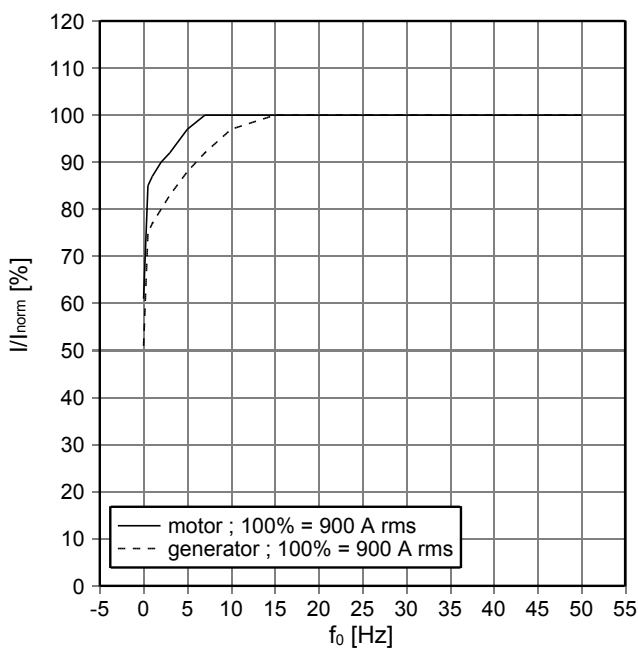

fsw - derating curve IGBT (motor), Diode (generator)
 cos(phi) = ± 0,85
 T_{cool medium} = 40°C

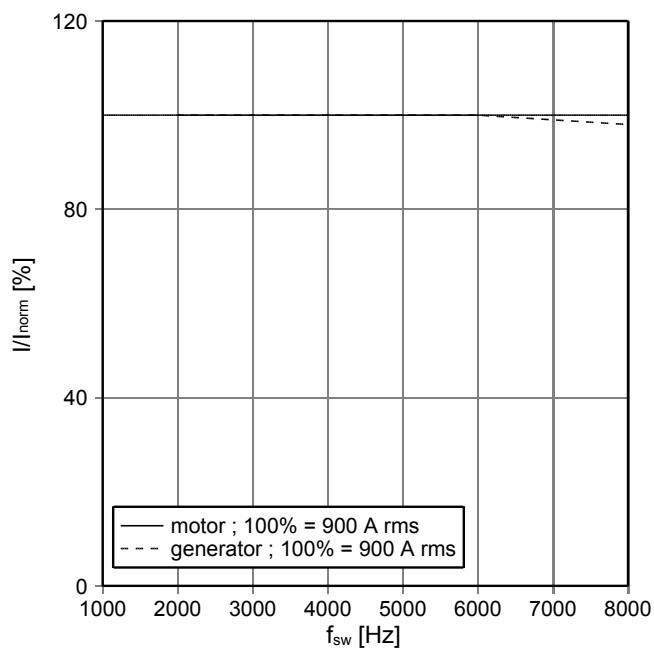

Continuous current derating curves vs. dc link voltage
 cos(phi) = ± 0,85
 T_{cool medium} = 40°C

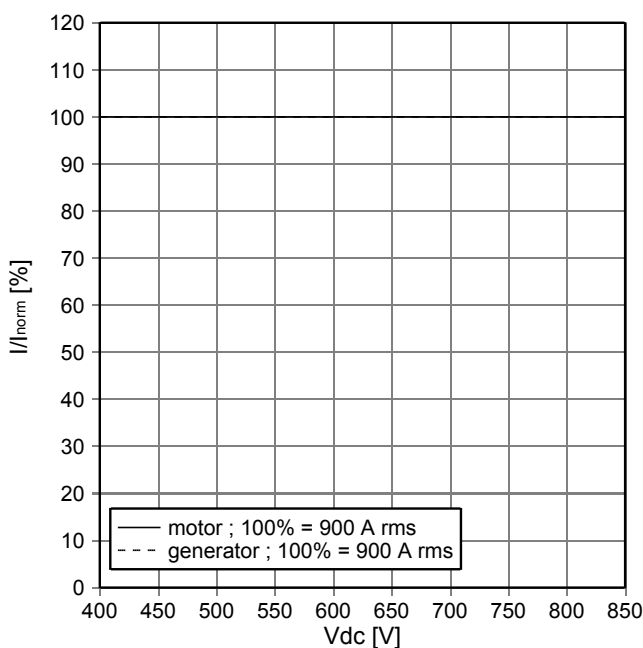

Continuous current derating curves vs. T_{cool medium}
 cos(phi) = ± 0,85

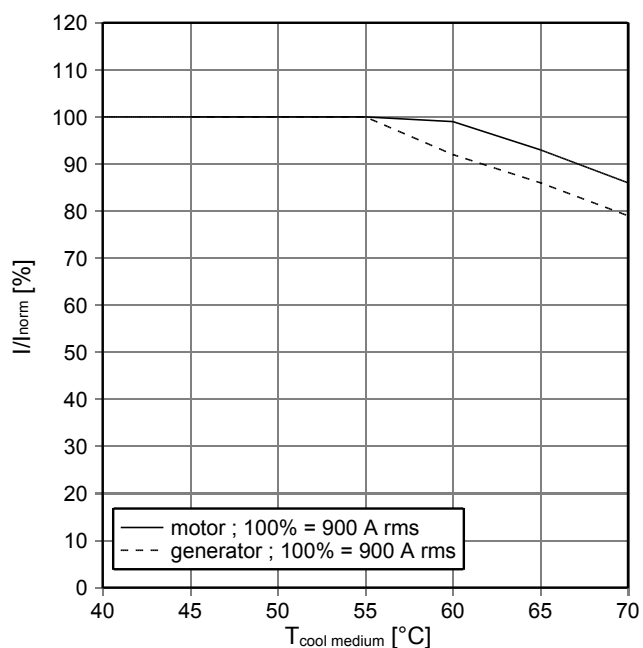

prepared by: OW	date of publication: 2014-03-17
approved by: KV	revision: 2.3



Preliminary data

Transient thermal impedance per switch

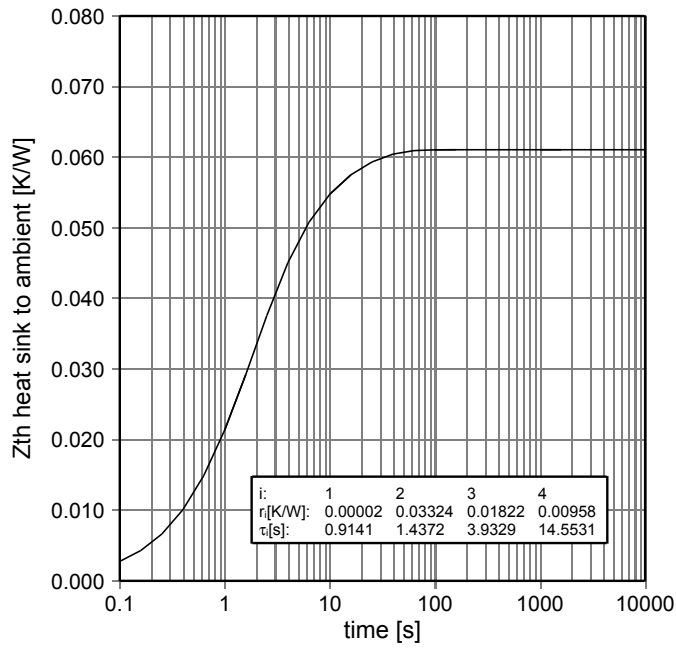

prepared by: OW	date of publication: 2014-03-17
approved by: KV	revision: 2.3

Circuit diagram

Circuit diagram

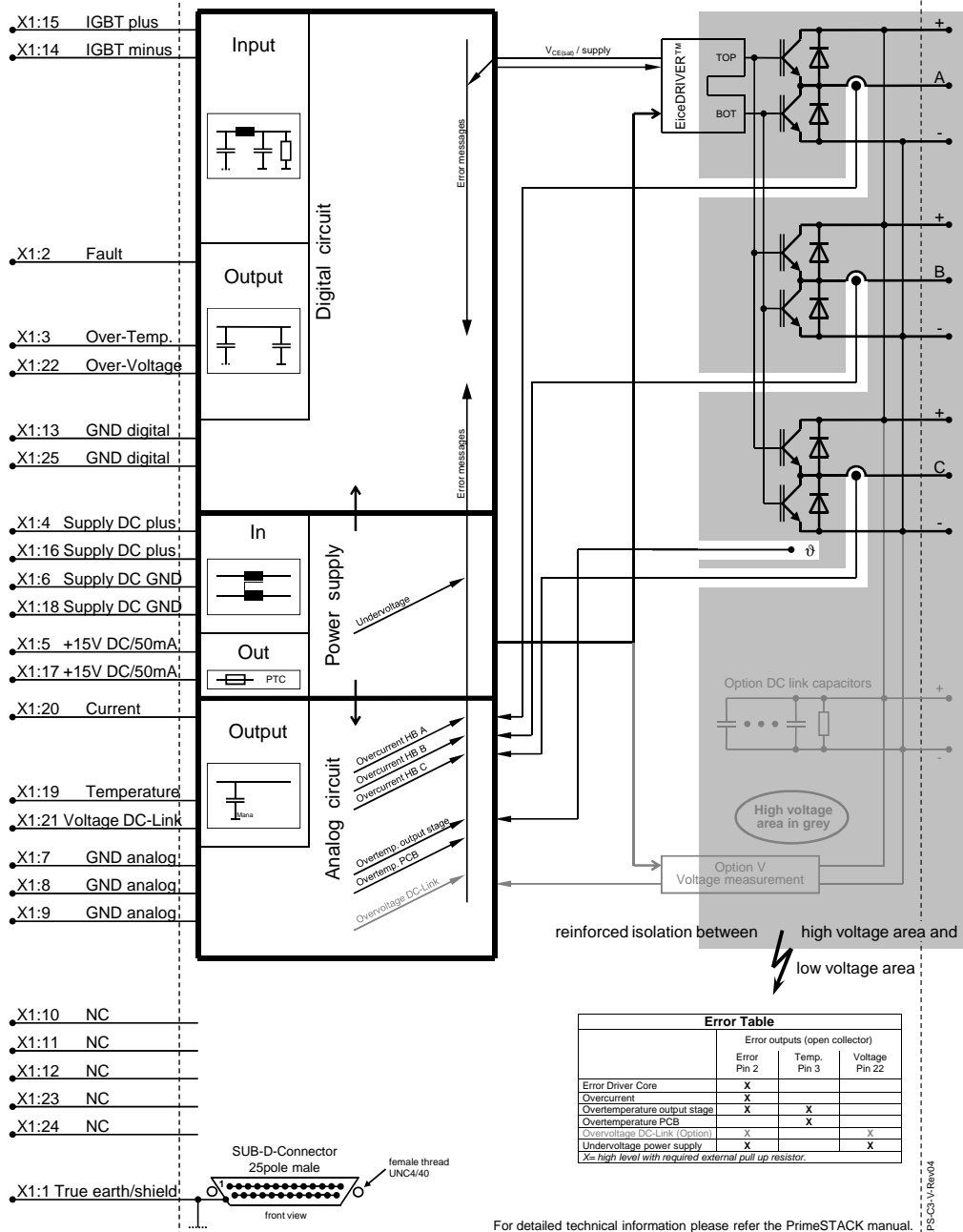

prepared by: OW	date of publication: 2014-03-17
approved by: KV	revision: 2.3



Preliminary data

Terms & Conditions of usage

The data contained in this product data sheet is exclusively intended for technically trained staff. You and your technical departments will have to evaluate the suitability of the product for the intended application and the completeness of the product data with respect to such application.

This product data sheet is describing the characteristics of this product for which a warranty is granted. Any such warranty is granted exclusively pursuant to the terms and conditions of the supply agreement. There will be no guarantee of any kind for the product and its characteristics.

Should you require product information in excess of the data given in this product data sheet or which concerns the specific application of our product, please contact the sales office, which is responsible for you (see www.infineon.com, sales&contact). For those that are specifically interested we may provide application notes.

Due to technical requirements our product may contain dangerous substances. For information on the types in question please contact the sales office, which is responsible for you.

Should you intend to use the Product in aviation applications, in health or live endangering or life support applications, please notify. Please note, that for any such applications we urgently recommend

- to perform joint Risk and Quality Assessments;
- the conclusion of Quality Agreements;
- to establish joint measures of an ongoing product survey, and that we may make delivery depended on the realization of any such measures.

If and to the extent necessary, please forward equivalent notices to your customers.

Changes of this product data sheet are reserved.

Safety Instructions

Prior to installation and operation, all safety notices and warnings and all warning signs attached to the equipment have to be carefully read. Make sure that all warning signs remain in a legible condition and that missing or damaged signs are replaced. To installation and operation, all safety notices and warnings and all warning signs attached to the equipment have to be carefully read. Make sure that all warning signs remain in a legible condition and that missing or damaged signs are replaced.

prepared by: OW	date of publication: 2014-03-17
approved by: KV	revision: 2.3