

**Product Summary**

- VR > 10V
- IF = 750mA
- IR = 1µA

**Description and Applications**

This compact SOD323 packaged Schottky diode offers users an excellent performance combination comprising high current operation, extremely low leakage and low forward voltage ensuring suitability for applications requiring efficient operation at higher temperatures (above 85°C) see Operational efficiency chart on page 4.

- Low power DC-DC conversion
- Level shifting
- Reverse blocking

**Features and Benefits**

- Extremely low leakage
- High current capability
- Low  $V_F$ , fast switching Schottky
- SOD323 package
- Package thermally rated to 150°C
- Lead, Halogen, and Antimony Free/RoHS Compliant (Note 1)
- “Green” Device (Note 2)

**Mechanical Data**

- Case: SOD323
- Case material: Molded Plastic. “Green” Molding Compound.
- UL Flammability Rating 94V-0
- Moisture Sensitivity: Level 1 per J-STD-020
- Terminals: Matte Tin Finish
- Weight: 0.0049 grams (Approximate)



SOD323



Device symbol



Partmark as example only for orientation

Top View Pin Configuration

**Ordering Information** (Note 3)

Device	Packaging	Shipping
ZLLS410TA	SOD323	3,000/Tape & Reel
ZLLS410TC	SOD323	10,000/Tape & Reel

- Notes:
1. No purposefully added lead. Halogen and Antimony Free.
  2. Diodes Inc's "Green" Policy can be found on our website at <http://www.diodes.com>
  3. For Packaging Details, go to our website at <http://www.diodes.com>.

**Marking Information**



41 = Product Type Marking Code

**Maximum Ratings** @T<sub>A</sub> = 25°C unless otherwise specified

Characteristic	Symbol	Value	Unit
Continuous Reverse Voltage	V <sub>R</sub>	10	V
Continuous Forward Current	I <sub>F</sub>	750	mA
Peak Repetitive Forward Current	I <sub>FPK</sub>	1.35	A
Rectangular Pulse Duty Cycle			
Non Repetitive Forward Current	I <sub>FSM</sub>	17	A
		4	A

**Thermal Characteristics**

Characteristic	Symbol	Value	Unit
Power Dissipation, T <sub>A</sub> = 25°C			
Single Die Continuous (Note 4)	P <sub>D</sub>	0.33	W
Single Die Measured at t < 5 secs (Note 5)		0.39	W
Junction to Ambient (Note 4)	R <sub>θJA</sub>	379	°C/W
Junction to Ambient (Note 5)	R <sub>θJA</sub>	317	°C/W
Storage Temperature Range	T <sub>STG</sub>	-55 to +150	°C

Notes: 4. For a device surface mounted on 25mm x 25mm x 1.6mm FR4 PCB with high coverage of single sided 1oz copper, in still air conditions.  
5. For a device surface mounted on FRB PCB measured at t < 5secs.

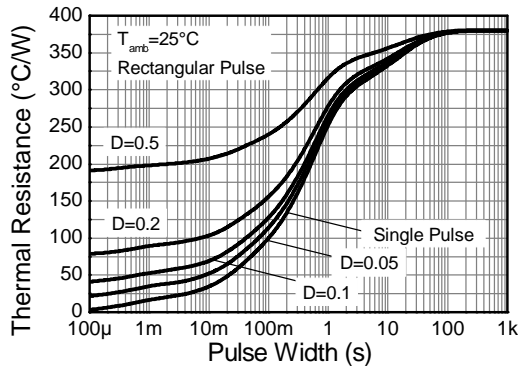

**Transient Thermal Impedance**

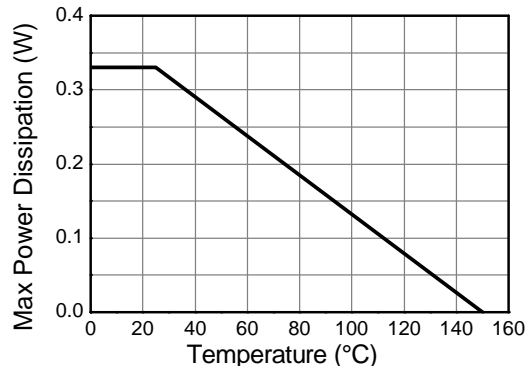

**Derating Curve**

**Electrical Characteristics** @T<sub>A</sub> = 25°C unless otherwise specified

Characteristic	Symbol	Min	Typ	Max	Unit	Test Condition
Reverse Breakdown Voltage	V <sub>(BR)R</sub>	10	–	–	V	I <sub>R</sub> = 200µA
Forward Voltage (Note 6)	V <sub>F</sub>	–	285	300	mV	I <sub>F</sub> = 10mA
		–	350	380	mV	I <sub>F</sub> = 100mA
		–	500	580	mV	I <sub>F</sub> = 1A
Reverse Current	I <sub>R</sub>	–	0.5	4	µA	V <sub>R</sub> = 5V
		–	0.7	5	µA	V <sub>R</sub> = 8V
		–	1	6	µA	V <sub>R</sub> = 10V
		–	–	200	µA	V <sub>R</sub> = 8V, T <sub>A</sub> = 85°C
Diode Capacitance	C <sub>D</sub>	–	37	–	pF	f = 1MHz, V <sub>R</sub> = 10V
Reverse Recovery Time	t <sub>rr</sub>	–	3	–	ns	Switched from I <sub>F</sub> = 500mA to V <sub>R</sub> = 5.5V
Reverse Recovery Charge	Q <sub>rr</sub>	–	210	–	pC	Measured @ I <sub>R</sub> = 50mA. di/dt = 500mA/ns, R <sub>source</sub> = 6Ω; R <sub>load</sub> = 10Ω

Notes: 6. Measured under pulsed conditions. Pulse width ≤ 300µs. Duty cycle < 2%

**Operational efficiency chart**

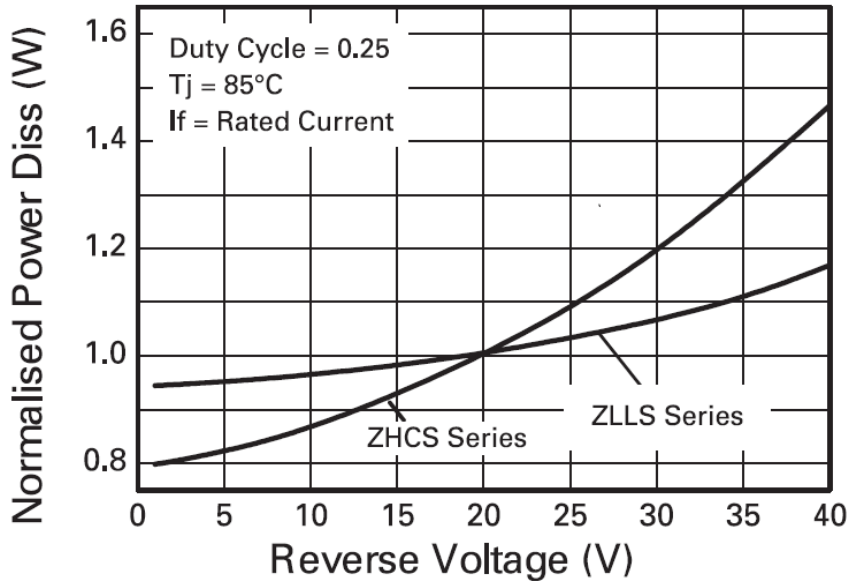

**Operational Efficiency Example**

The operational efficiency chart indicates the beneficial use of the ZLLS series diodes in applications requiring higher voltage, higher temperature operation. Circuits requiring low voltage low temperature operation will benefit from using Zetex low V<sub>F</sub> ZHCS series diodes.

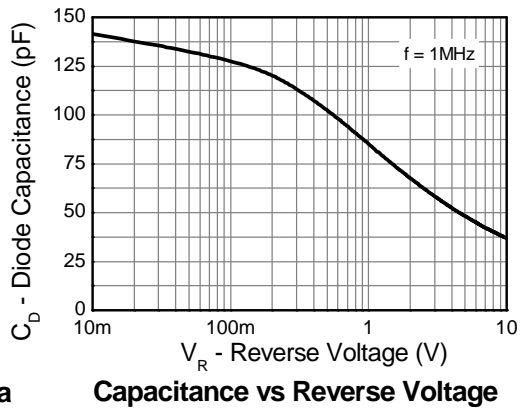
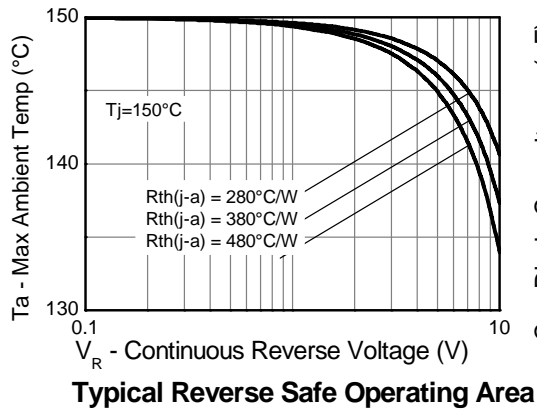
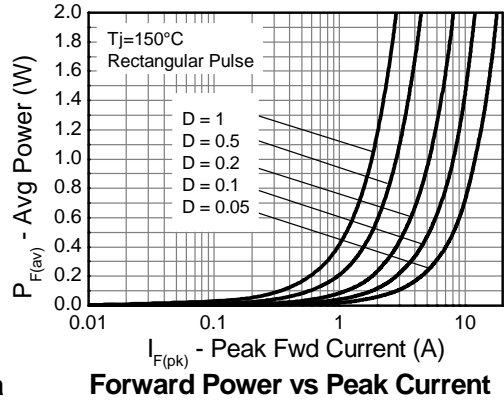
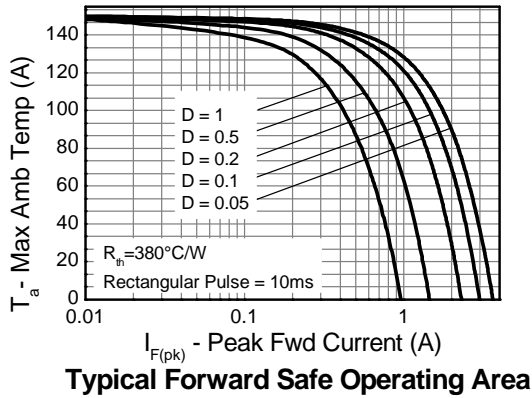
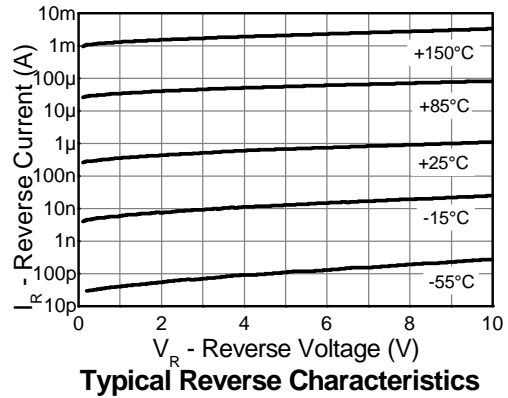
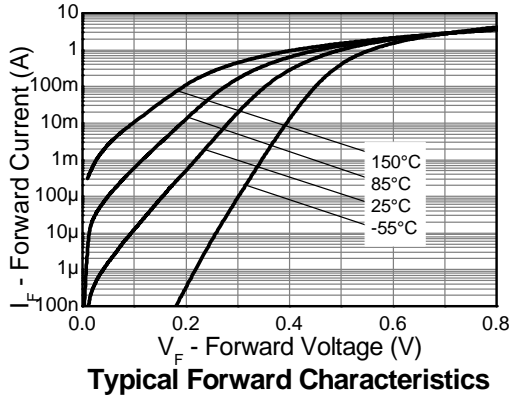

**Package Outline Dimensions**

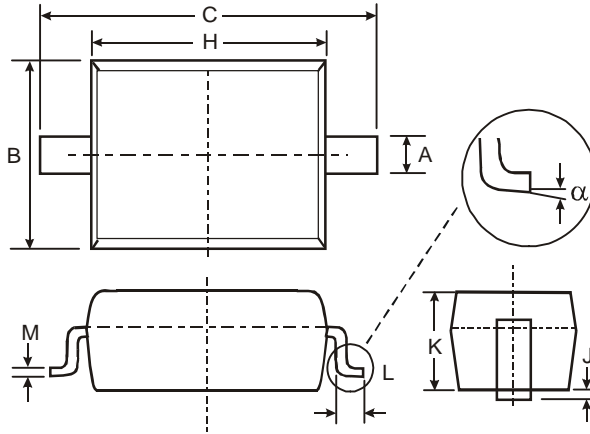

SOD323		
Dim	Min	Max
A	0.25	0.35
B	1.20	1.40
C	2.30	2.70
H	1.60	1.80
J	0.00	0.10
K	1.0	1.1
L	0.20	0.40
M	0.10	0.15
$\alpha$	0°	8°
All Dimensions in mm		

**Suggested Pad Layout**

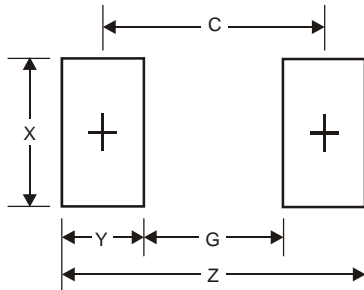

Dimensions	Value (in mm)
Z	3.75
G	1.05
X	0.65
Y	1.35
C	2.40

**IMPORTANT NOTICE**

DIODES INCORPORATED MAKES NO WARRANTY OF ANY KIND, EXPRESS OR IMPLIED, WITH REGARDS TO THIS DOCUMENT, INCLUDING, BUT NOT LIMITED TO, THE IMPLIED WARRANTIES OF MERCHANTABILITY AND FITNESS FOR A PARTICULAR PURPOSE (AND THEIR EQUIVALENTS UNDER THE LAWS OF ANY JURISDICTION).

Diodes Incorporated and its subsidiaries reserve the right to make modifications, enhancements, improvements, corrections or other changes without further notice to this document and any product described herein. Diodes Incorporated does not assume any liability arising out of the application or use of this document or any product described herein; neither does Diodes Incorporated convey any license under its patent or trademark rights, nor the rights of others. Any Customer or user of this document or products described herein in such applications shall assume all risks of such use and will agree to hold Diodes Incorporated and all the companies whose products are represented on Diodes Incorporated website, harmless against all damages.

Diodes Incorporated does not warrant or accept any liability whatsoever in respect of any products purchased through unauthorized sales channel. Should Customers purchase or use Diodes Incorporated products for any unintended or unauthorized application, Customers shall indemnify and hold Diodes Incorporated and its representatives harmless against all claims, damages, expenses, and attorney fees arising out of, directly or indirectly, any claim of personal injury or death associated with such unintended or unauthorized application.

Products described herein may be covered by one or more United States, international or foreign patents pending. Product names and markings noted herein may also be covered by one or more United States, international or foreign trademarks.

**LIFE SUPPORT**

Diodes Incorporated products are specifically not authorized for use as critical components in life support devices or systems without the express written approval of the Chief Executive Officer of Diodes Incorporated. As used herein:

A. Life support devices or systems are devices or systems which:

1. are intended to implant into the body, or
2. support or sustain life and whose failure to perform when properly used in accordance with instructions for use provided in the labeling can be reasonably expected to result in significant injury to the user.

B. A critical component is any component in a life support device or system whose failure to perform can be reasonably expected to cause the failure of the life support device or to affect its safety or effectiveness.

Customers represent that they have all necessary expertise in the safety and regulatory ramifications of their life support devices or systems, and acknowledge and agree that they are solely responsible for all legal, regulatory and safety-related requirements concerning their products and any use of Diodes Incorporated products in such safety-critical, life support devices or systems, notwithstanding any devices- or systems-related information or support that may be provided by Diodes Incorporated. Further, Customers must fully indemnify Diodes Incorporated and its representatives against any damages arising out of the use of Diodes Incorporated products in such safety-critical, life support devices or systems.

Copyright © 2012, Diodes Incorporated

**[www.diodes.com](http://www.diodes.com)**