

# ESD106-B1-W0201

Bi-directional ESD protection device, 5.5 V, 0.13 pF, 0201

- Order now
- Technical documents
- Simulation
- Support

## Product description

This Infineon ESD (electrostatic discharge) protection device has a bi-directional and symmetric I/V characteristic and excellent clamping performance.

## Feature list

- ESD / transient protection according to:
  - IEC61000-4-2 (ESD):  $\pm 15$  kV (air) /  $\pm 12$  kV (contact)
  - IEC61000-4-4 (EFT):  $\pm 1.5$  kV /  $\pm 30$  A (5/50 ns)
  - IEC61000-4-5 (Surge):  $\pm 1.5$  A (8/20  $\mu$ s)
- Bi-directional maximum working voltage:  $V_{WM} = \pm 5.5$  V
- Line capacitance:  $C_L = 0.13$  pF at  $f = 2.5$  GHz
- Clamping voltage:  $V_{cl} = 25$  V at  $I_{TLP} = 16$  A with  $R_{dyn} = 1.1 \Omega$
- Very low leakage current:  $I_L = 1$  nA
- Small form factor SMD size 0201, low profile (0.58 x 0.28 x 0.15 mm<sup>3</sup>)



## Potential applications

Tailored for ESD protection and capacitance sensitive applications like:

- Super high speed interface
- RF antenna

## Product validation

Qualified for industrial applications according to the relevant tests of JEDEC47/20/22.

## Device information

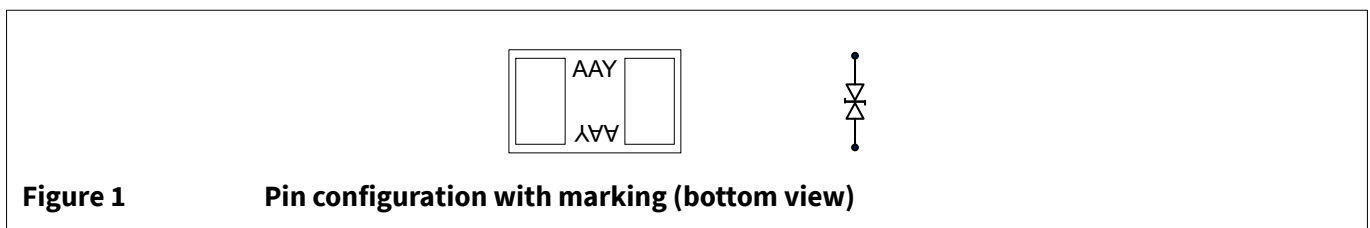

**Table 1** Part information

Product name / Ordering code	Package	Pin configuration	Marking	Pieces / Reel
ESD106-B1-W0201 / ESD106B1W0201E6327XTSA1	WLL-2-3	1 line, bi-directional	AAY	15 k

---

**Table of contents**

**Table of contents**

	<b>Product description</b> .....	1
	<b>Feature list</b> .....	1
	<b>Potential applications</b> .....	1
	<b>Product validation</b> .....	1
	<b>Device information</b> .....	1
	<b>Table of contents</b> .....	2
<b>1</b>	<b>Absolute maximum ratings</b> .....	3
<b>2</b>	<b>Electrical characteristics</b> .....	4
<b>3</b>	<b>Typical characteristic diagrams</b> .....	6
<b>4</b>	<b>Package information WLL-2-3</b> .....	11
<b>5</b>	<b>References</b> .....	12
<b>6</b>	<b>Revision history</b> .....	12
	<b>Disclaimer</b> .....	13

## 1 Absolute maximum ratings

### 1 Absolute maximum ratings

**Table 2** Absolute maximum ratings at  $T_A = 25^\circ\text{C}$ , unless otherwise specified

Parameter	Symbol	Values		Unit	Note or test condition
		Min.	Max.		
Working voltage	$V_{WM}$	-5.5	+5.5	V	
ESD discharge voltage	$V_{ESD}$ (contact)	-12	+12	kV	Discharge network: $R = 330 \Omega$ , $C = 150 \text{ pF}$ <sup>1)</sup>
	$V_{ESD}$ (air)	-15	+15		
Peak pulse power	$P_{PK}$	-	15	W	Stress pulse: 8/20 $\mu\text{s}$ current waveform <sup>2)</sup>
Peak pulse current	$I_{PP}$	-1.5	+1.5	A	
Operating temperature	$T_{op}$	-55	+125	$^\circ\text{C}$	
Storage temperature	$T_{stg}$	-65	+150		

**Attention:** Stresses above the maximum values listed here may cause permanent damage to the device. Exposure to absolute maximum rating conditions for extended periods may affect device reliability. Maximum ratings are absolute ratings. Exceeding only one of these values may cause irreversible damage to the component.

<sup>1</sup> Based on IEC61000-4-2.

<sup>2</sup> Based on IEC61000-4-5.

**2 Electrical characteristics**

**2 Electrical characteristics**

Note:  $T_A = 25^\circ\text{C}$ , unless otherwise specified. Device is electrically symmetrical.

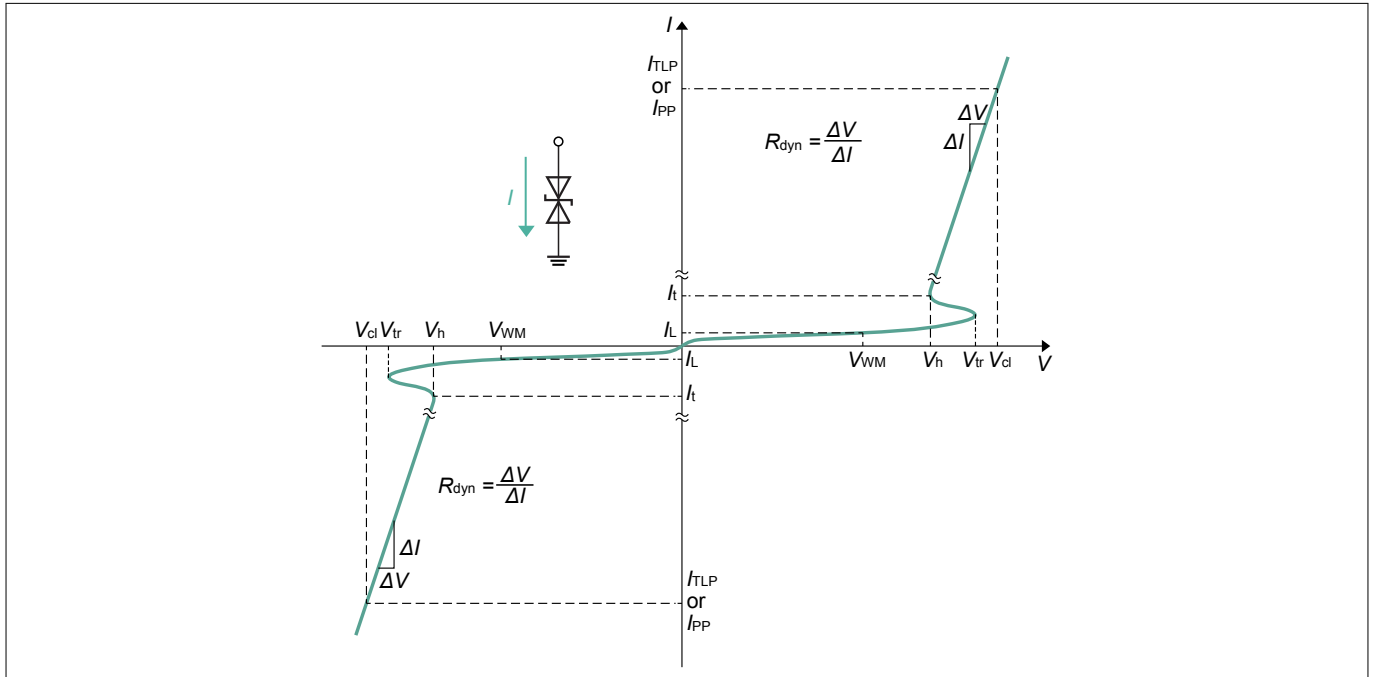

**Figure 2** I/V characteristic curve

**Table 3** I/V characteristic parameters

Symbol	Parameter
$I_h$	Holding current
$I_L$	Leakage current
$I_{PP}$	Peak pulse current, based on IEC61000-4-5
$I_t$	Test current
$I_{TLP}$	TLP current
$R_{dyn}$	Dynamic resistance
$V_{cl}$	Clamping voltage
$V_h$	Holding voltage
$V_t$	Test voltage
$V_{tr}$	Trigger voltage
$V_{WM}$	Maximum working voltage

**2 Electrical characteristics**

**Table 4 DC characteristics**

Parameter	Symbol	Values			Unit	Note or test condition
		Min.	Typ.	Max.		
Trigger voltage <sup>3)</sup>	$V_{tr}$	6.1	9.5	-	V	
Holding voltage	$V_h$	6.1	7.5	9		$I_t = 1 \text{ mA}$
Leakage current	$I_L$	-	1	20	nA	$V_{WM} = 5.5 \text{ V}$

**Table 5 AC characteristics**

Parameter	Symbol	Values			Unit	Note or test condition
		Min.	Typ.	Max.		
Line capacitance	$C_L$	-	-	0.25	pF	$V = 0 \text{ V}, f = 1 \text{ MHz}$
		-	0.13	-		$V = 0 \text{ V}, f = 2.5 \text{ GHz}$
Series inductance	$L_S$	-	<0.1	-	nH	Extracted from S-parameters

**Table 6 Protection characteristics**

Parameter	Symbol	Values			Unit	Note or test condition
		Min.	Typ.	Max.		
Clamping voltage (TLP) <sup>4) 5)</sup>	$V_{cl}$	-	12.2	-	V	$I_{TLP} = 4 \text{ A}$
		-	16	-		$I_{TLP} = 8 \text{ A}$
		-	25	-		$I_{TLP} = 16 \text{ A}$
Clamping voltage (8/20 $\mu\text{s}$ ) <sup>6)</sup>		-	8.5	-		$I_{PP} = 1 \text{ A}$
		-	10	-		$I_{PP} = 1.5 \text{ A}$
Dynamic resistance <sup>4)</sup>	$R_{dyn}$	-	1.1	-	$\Omega$	

<sup>3</sup> Verified by design.

<sup>4</sup> TLP parameters:  $Z_0 = 50 \Omega$ ,  $t_p = 100 \text{ ns}$ ,  $t_r = 0.6 \text{ ns}$ , averaging window 30-60 ns.

<sup>5</sup> Refer to application note AN210 [\[2\]](#)

<sup>6</sup>  $t_p = 8/20 \mu\text{s}$ . Stress pulse based on IEC61000-4-5.

3 Typical characteristic diagrams

### 3 Typical characteristic diagrams

Note:  $T_A = 25\text{ }^\circ\text{C}$ , unless otherwise specified.

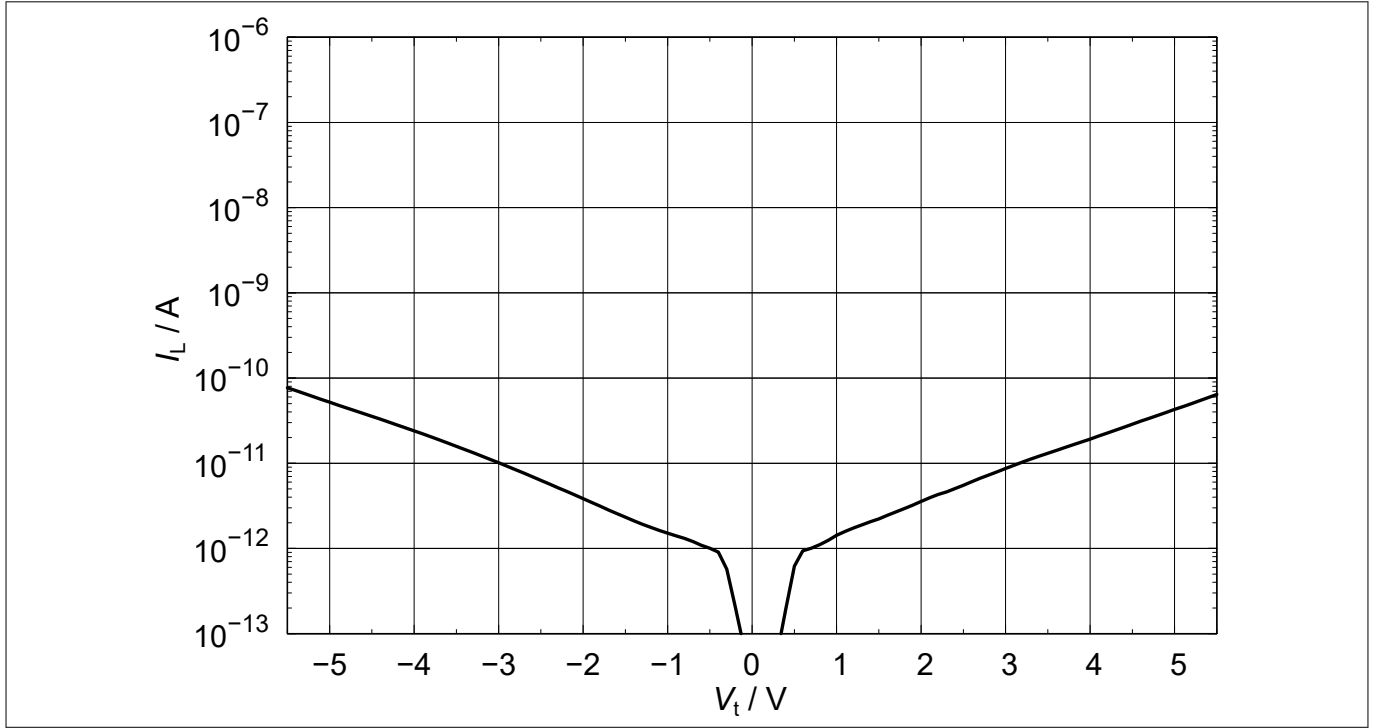

Figure 3 Leakage current:  $I_L = f(V_t)$

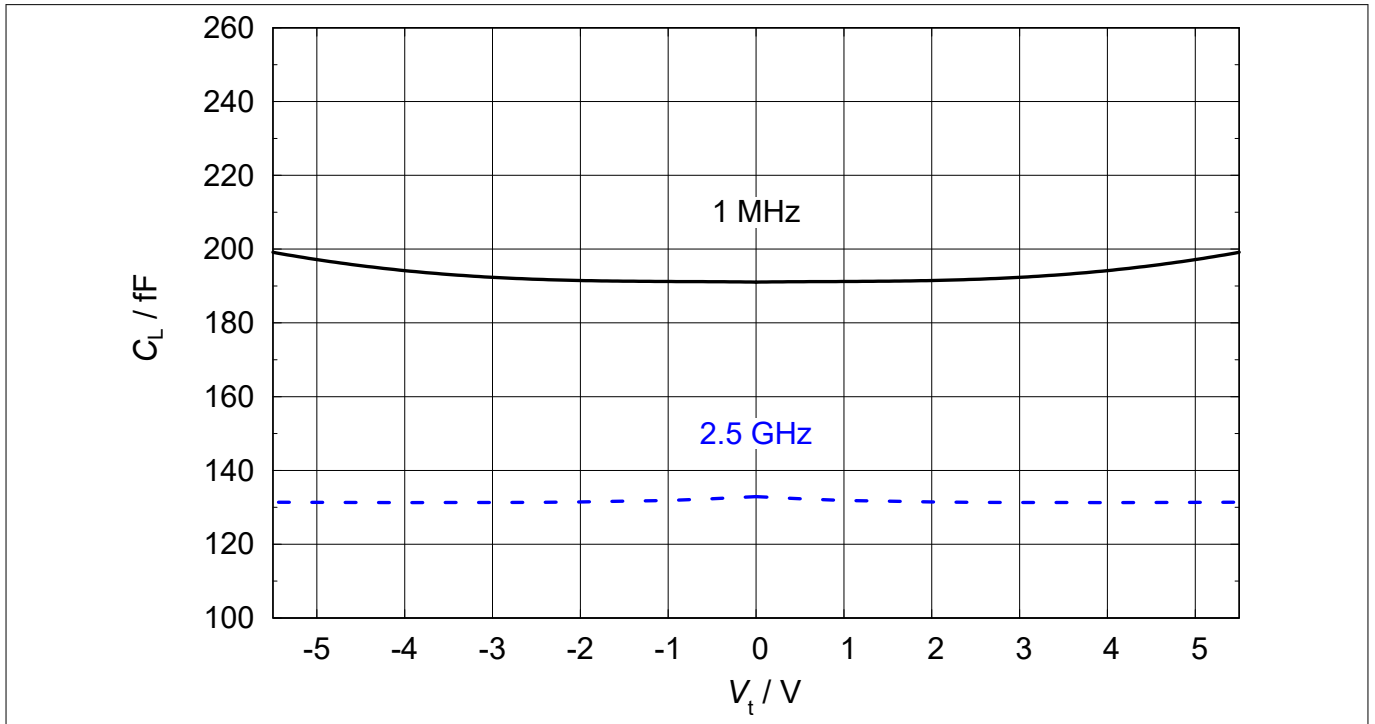
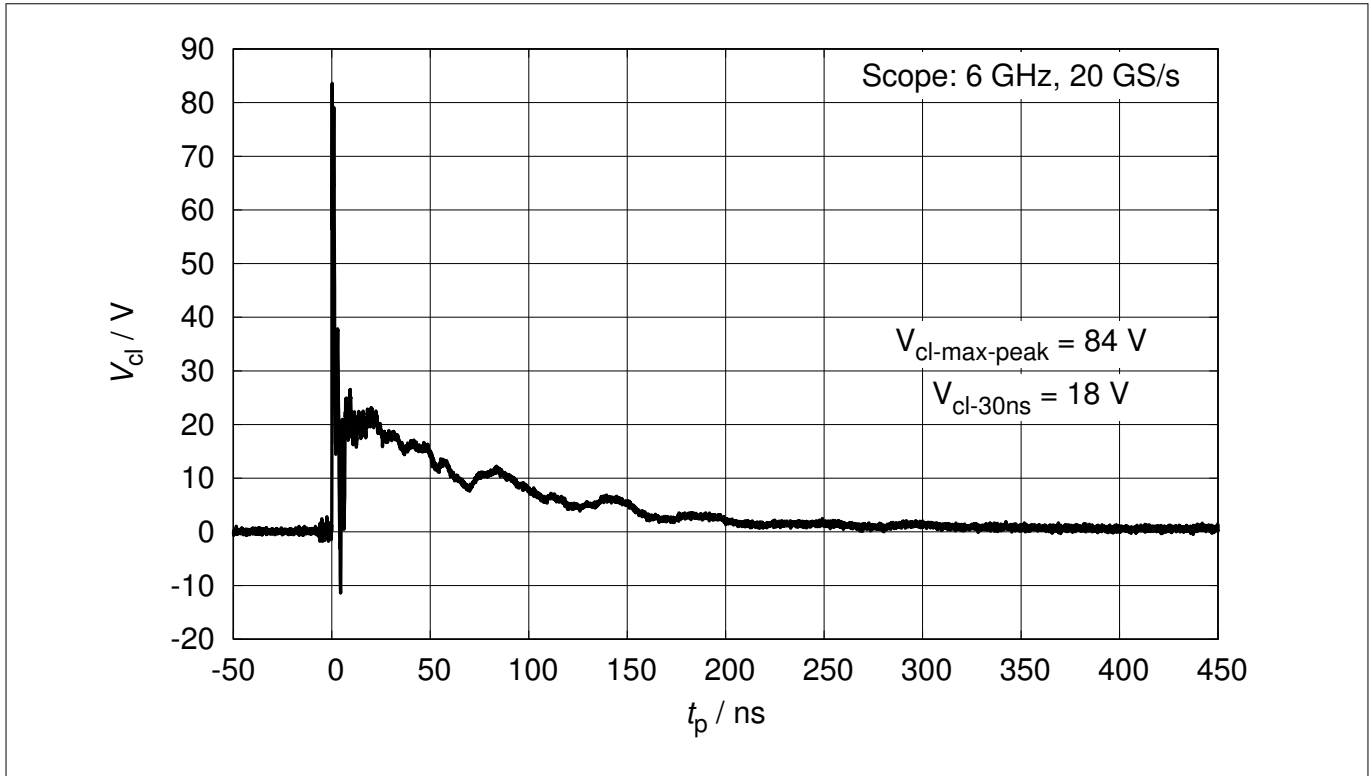
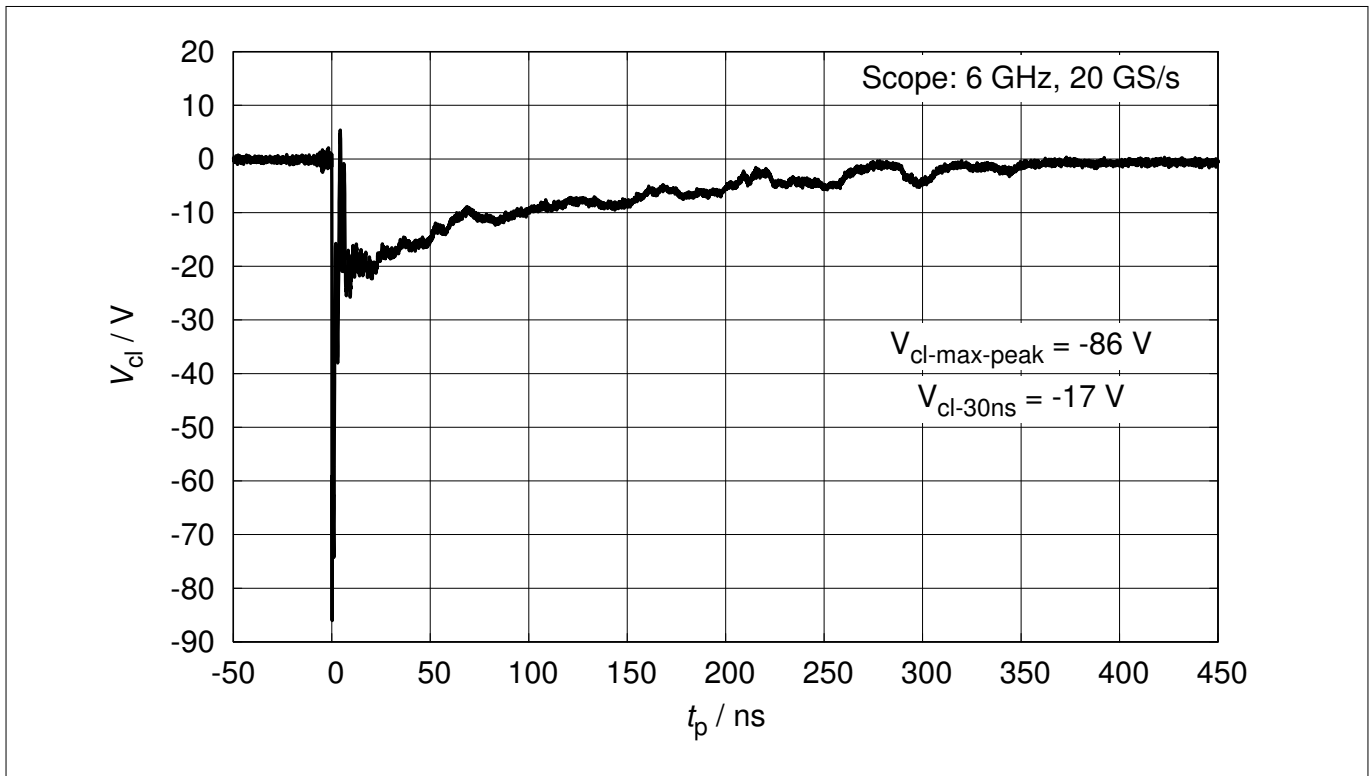

Figure 4 Line capacitance:  $C_L = f(V_t)$ ,  $f = 1\text{ MHz}, 2.5\text{ GHz}$

**3 Typical characteristic diagrams**

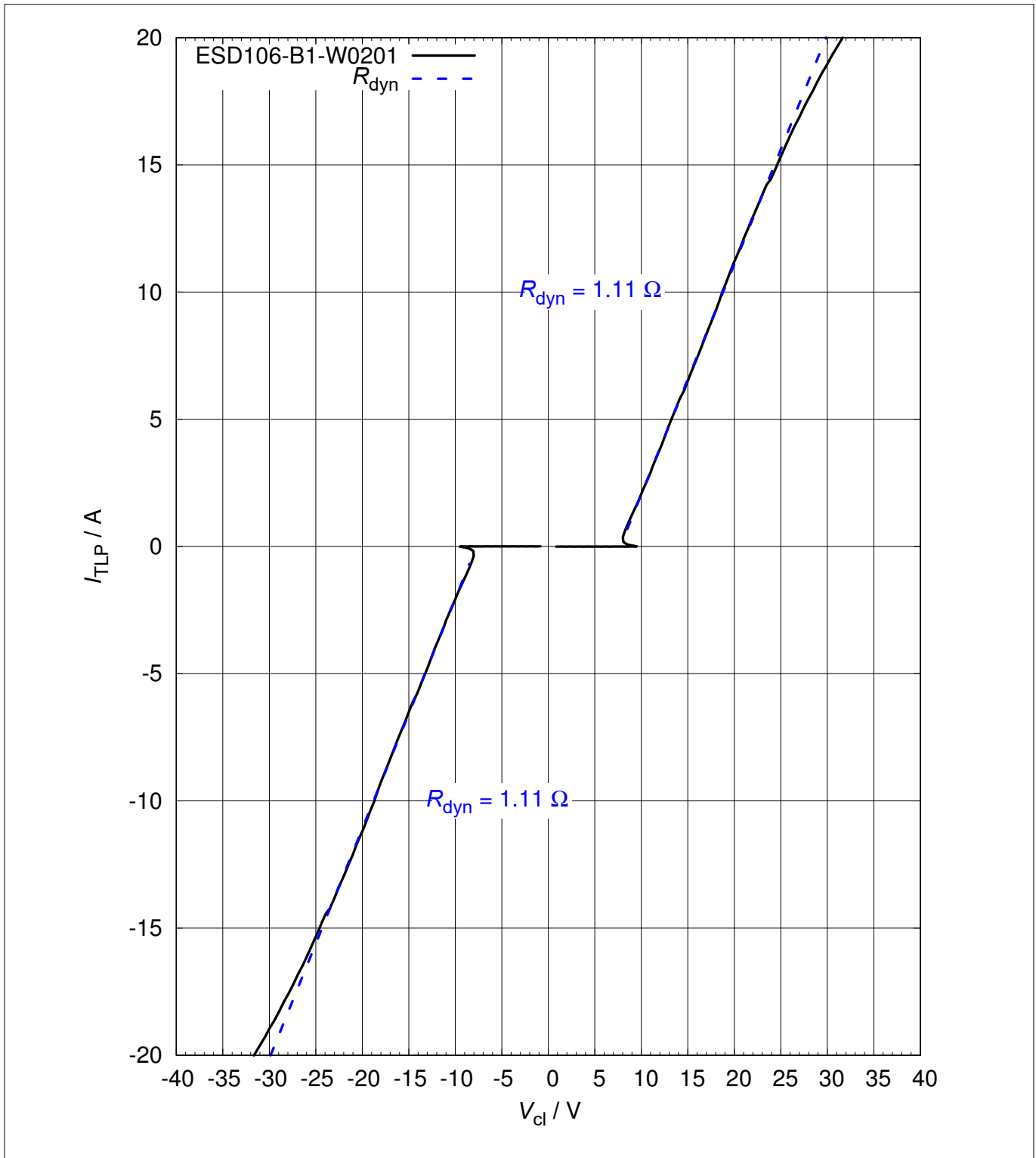

**Figure 5 Clamping voltage (ESD):  $V_{cl} = f(t_p)$ , 8 kV positive pulse based on IEC61000-4-2**



**Figure 6 Clamping voltage (ESD):  $V_{cl} = f(t_p)$ , 8 kV negative pulse based on IEC61000-4-2**

**3 Typical characteristic diagrams**



**Figure 7** Clamping voltage (TLP):  $I_{TLP} = f(V_{cl})$



**3 Typical characteristic diagrams**

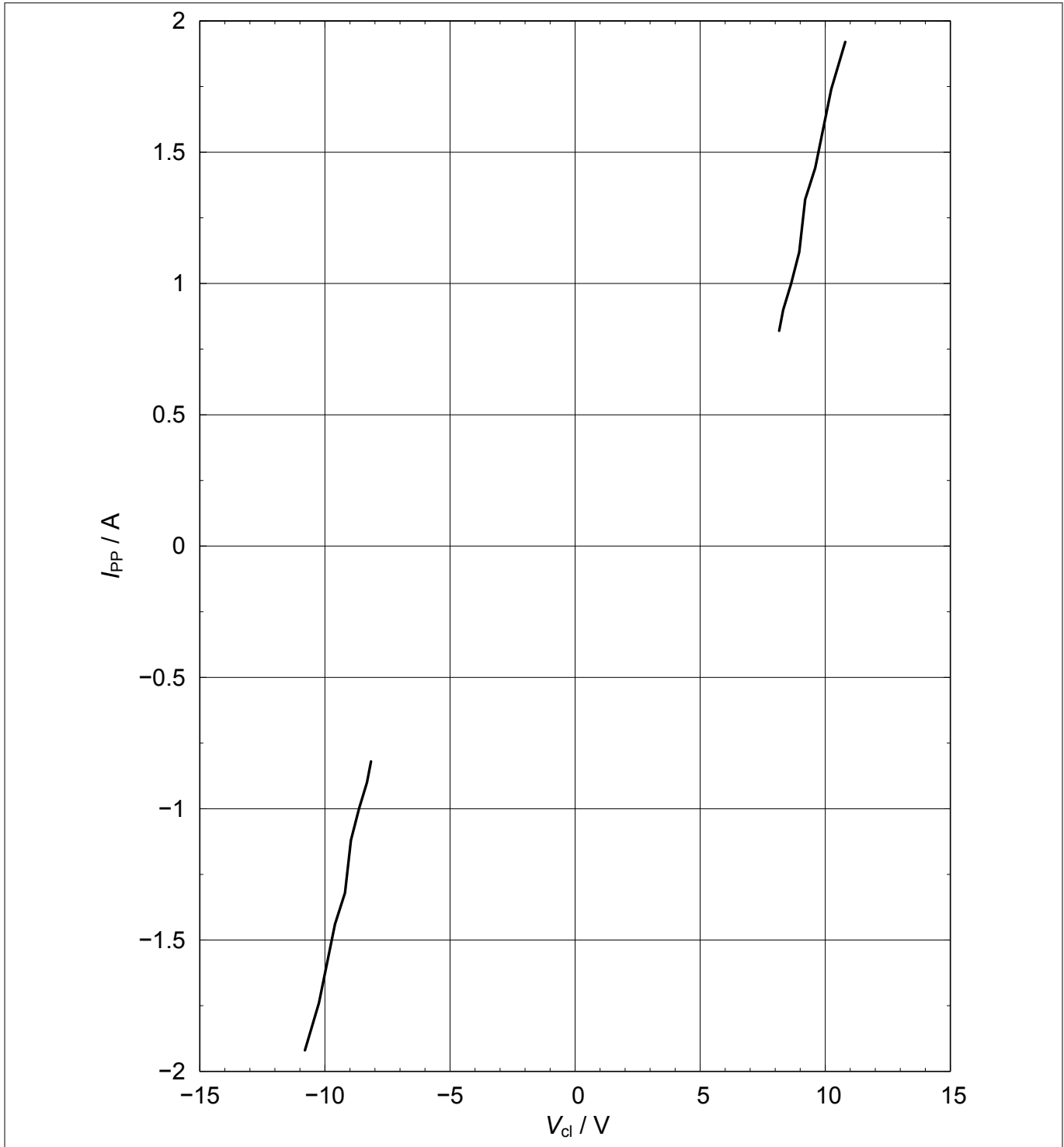

**Figure 8 Clamping voltage (Surge):  $I_{PP} = f(V_{cl})$ , based on IEC61000-4-5**

**3 Typical characteristic diagrams**

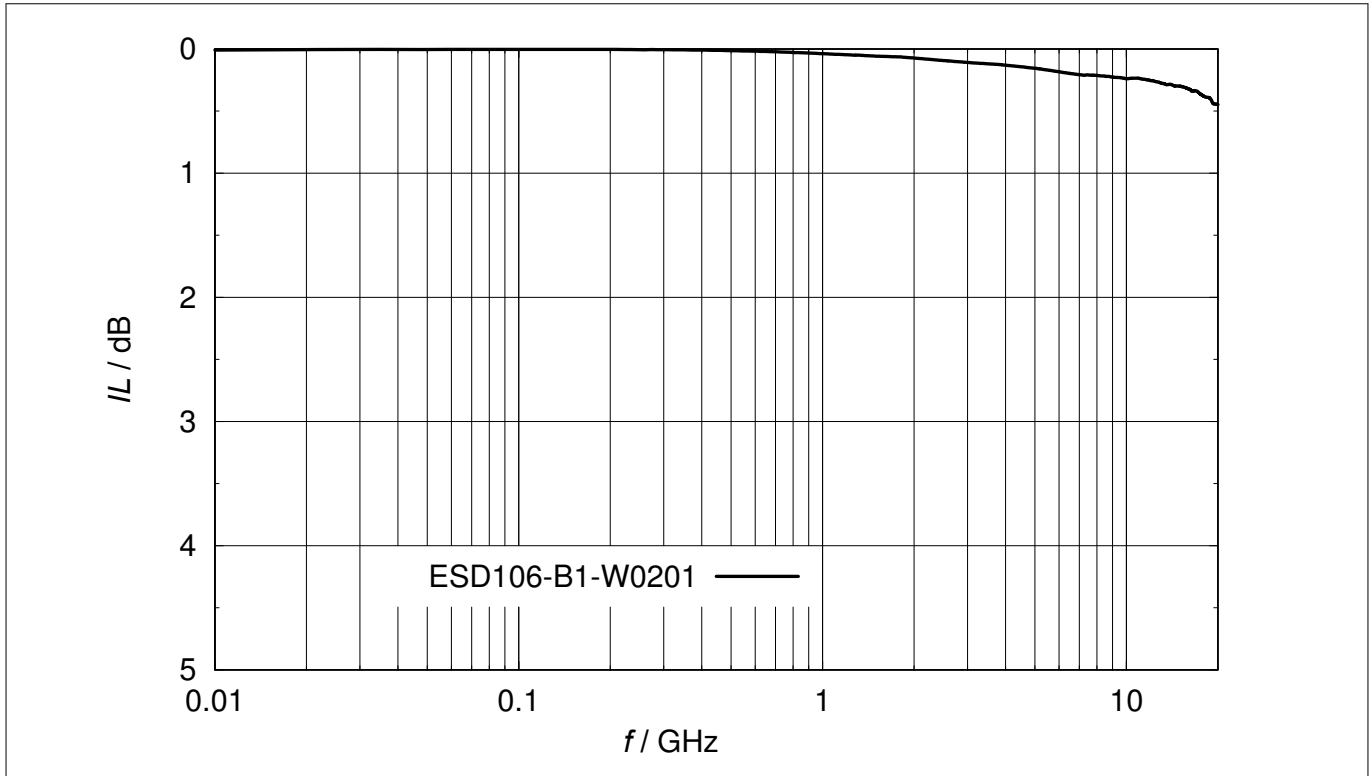

**Figure 9** Insertion loss  $IL = f(f)$ , measured in a 50  $\Omega$  system

4 Package information WLL-2-3

### 4 Package information WLL-2-3

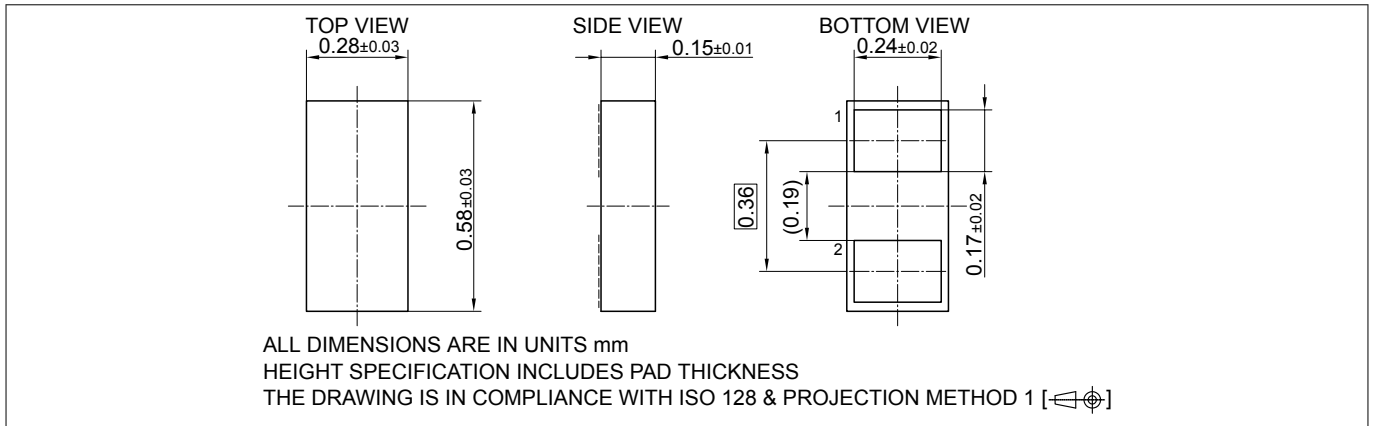

Figure 10 WLL-2-3 package

Note: For package information including footprint, packing and assembly recommendation refer to:

<https://www.infineon.com/packages/SG-WLL-2-3/>

---

**5 References**

**5 References**

[1]	Infineon AG - Understanding ESD protection device characteristics
[2]	Infineon AG - <b>Application note AN210</b> : Effective ESD Protection Design at System Level Using VF-TLP Characterization Methodology

**6 Revision history**

Document version	Date of release	Description of changes
1.0	2018-09-19	<ul style="list-style-type: none"><li>• VESD (air) value updated</li></ul>
1.1	2018-09-21	<ul style="list-style-type: none"><li>• CL diagram updated</li></ul>
2.0	2019-08-09	<ul style="list-style-type: none"><li>• New datasheet layout, values updated</li></ul>
2.1	2020-06-22	<ul style="list-style-type: none"><li>• Datasheet layout update</li></ul>

## Trademarks

All referenced product or service names and trademarks are the property of their respective owners.

**Edition 2020-06-22**

**Published by**  
**Infineon Technologies AG**  
**81726 Munich, Germany**

**© 2020 Infineon Technologies AG**  
**All Rights Reserved.**

**Do you have a question about any aspect of this document?**  
**Email: [erratum@infineon.com](mailto:erratum@infineon.com)**

**Document reference**  
**IFX-r1z1584369202658**

## IMPORTANT NOTICE

The information given in this document shall in no event be regarded as a guarantee of conditions or characteristics ("Beschaffheitsgarantie").

With respect to any examples, hints or any typical values stated herein and/or any information regarding the application of the product, Infineon Technologies hereby disclaims any and all warranties and liabilities of any kind, including without limitation warranties of non-infringement of intellectual property rights of any third party.

In addition, any information given in this document is subject to customer's compliance with its obligations stated in this document and any applicable legal requirements, norms and standards concerning customer's products and any use of the product of Infineon Technologies in customer's applications.

The data contained in this document is exclusively intended for technically trained staff. It is the responsibility of customer's technical departments to evaluate the suitability of the product for the intended application and the completeness of the product information given in this document with respect to such application.

## WARNINGS

Due to technical requirements products may contain dangerous substances. For information on the types in question please contact your nearest Infineon Technologies office.

Except as otherwise explicitly approved by Infineon Technologies in a written document signed by authorized representatives of Infineon Technologies, Infineon Technologies' products may not be used in any applications where a failure of the product or any consequences of the use thereof can reasonably be expected to result in personal injury.