

PTFC270101M

High Power RF LDMOS Field Effect Transistor
10 W, 28 V, 900 – 2700 MHz

Description

The PTFC270101M is an unmatched 10-watt LDMOS FET suitable for power amplifier applications with frequencies from 900 MHz to 2700 MHz. This LDMOS transistor offers excellent gain, efficiency and linearity performance in a small overmolded plastic package.

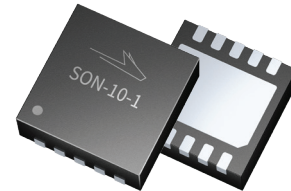

PTFC270101M
Package PG-SON-10

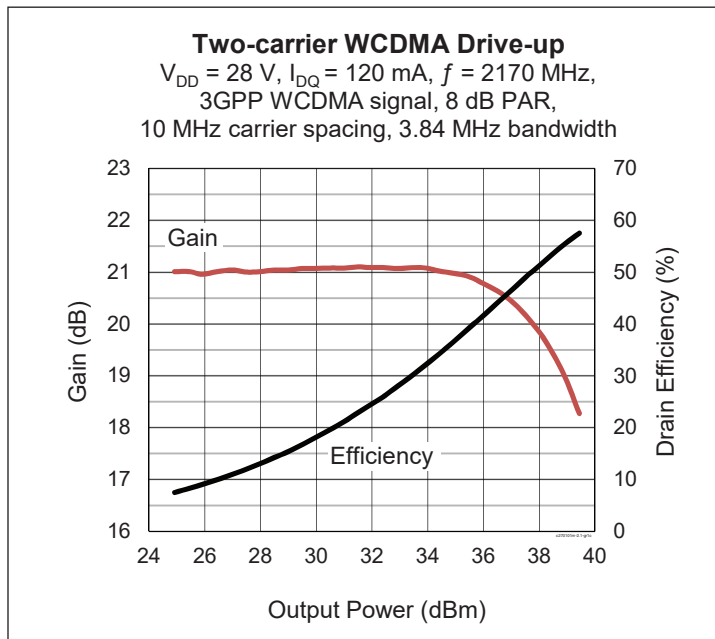

Features

- Unmatched input and output
- Typical CW performance, 2170 MHz, 28 V
 - Output power @ $P_{1dB} = 10\text{ W}$
 - Gain = 20 dB
 - Efficiency = 60%
- Typical two-carrier WCDMA performance, 2170 MHz, 28 V, 8 dB PAR
 - Output power = 1.3 W avg
 - Gain = 21 dB
 - Efficiency = 21%
 - ACPR = -44.9 dBc @ 5 MHz
- Capable of handling 10:1 VSWR @ 28 V, 10 W (CW) output power
- Integrated ESD protection
- Pb-free and RoHS compliant

RF Characteristics

Two-carrier WCDMA Specifications (tested in Wolfspeed production test fixture)

$V_{DD} = 28\text{ V}$, $I_{DQ} = 120\text{ mA}$, $P_{OUT} = 2.4\text{ W avg}$, $f = 2170\text{ MHz}$
 3GPP WCDMA signal, 3.84 MHz channel bandwidth, 8 dB peak/average @ 0.01% CCDF

Characteristic	Symbol	Min	Typ	Max	Unit
Gain	G_{ps}	19.5	20.5	—	dB

All published data at $T_{CASE} = 25^\circ\text{C}$ unless otherwise indicated
 ESD: Electrostatic discharge sensitive device—observe handling precautions!



DC Characteristics

Characteristic	Conditions	Symbol	Min	Typ	Max	Unit
Drain-Source Breakdown Voltage	$V_{GS} = 0\text{ V}, I_{DS} = 10\text{ mA}$	$V_{(BR)DSS}$	65	—	—	V
Drain Leakage Current	$V_{DS} = 28\text{ V}, V_{GS} = 0\text{ V}$	I_{DSS}	—	—	1	μA
	$V_{DS} = 63\text{ V}, V_{GS} = 0\text{ V}$	I_{DSS}	—	—	10	μA
Gate Leakage Current	$V_{GS} = 10\text{ V}, V_{DS} = 0\text{ V}$	I_{GSS}	—	1	—	μA
On-State Resistance	$V_{GS} = 10\text{ V}, V_{DS} = 0.1\text{ V}$	$R_{DS(on)}$	—	1	—	Ω
Operating Gate Voltage	$V_{DS} = 28\text{ V}, I_{DQ} = 120\text{ mA}$	V_{GS}	2.2	2.7	3.2	V

Maximum Ratings

Parameter	Symbol	Value	Unit
Drain-Source Voltage	V_{DSS}	65	V
Gate-Source Voltage	V_{GS}	-6 to +10	V
Operating Voltage	V_{DD}	0 to +32	V
Junction Temperature	T_J	225	$^{\circ}\text{C}$
Storage Temperature Range	T_{STG}	-65 to +150	$^{\circ}\text{C}$
Thermal Resistance ($T_{CASE} = 70^{\circ}\text{C}, 12\text{ W CW}$)	$R_{\theta JC}$	4.04	$^{\circ}\text{C/W}$

Moisture Sensitivity Level

Level	Test Standard	Package Temperature	Unit
3	IPC/JEDEC J-STD-020	260	$^{\circ}\text{C}$

ESD Ratings

Test Type	Rated Class	Standard
Human Body Model (HBM)	1B	ANSI/ESDA/JEDEC JS-001
Charge Device Model (CDM)	II	JESD 22-C101

Ordering Information

Type	Order Code	Package and Description	Shipping
PTFC270101M V1 R1K	PTFC270101M-V1-R1K	PG-SON-10, molded plastic, SMD	Tape & Reel, 1000 pcs

Evaluation Boards

Order Code	Frequency	Description
LTN/PTFC270101M V1	2110 – 2170 MHz	Class AB with combined outputs, R04360, 0.508 mm thick
LTN/PTFC270101M E3	2620 – 2690 MHz	Class AB with combined outputs, R04360, 0.508 mm thick
LTN/PTFC270101M E4	920 – 960 MHz	Class AB with combined outputs, R04360, 0.508 mm thick

Find Gerber files for these reference fixtures on the Wolfspeed Web site at www.wolfspeed.com/RF

See next page for Typical RF Performance



Typical RF Performance, 2110 – 2170 MHz (data taken in production test fixture)

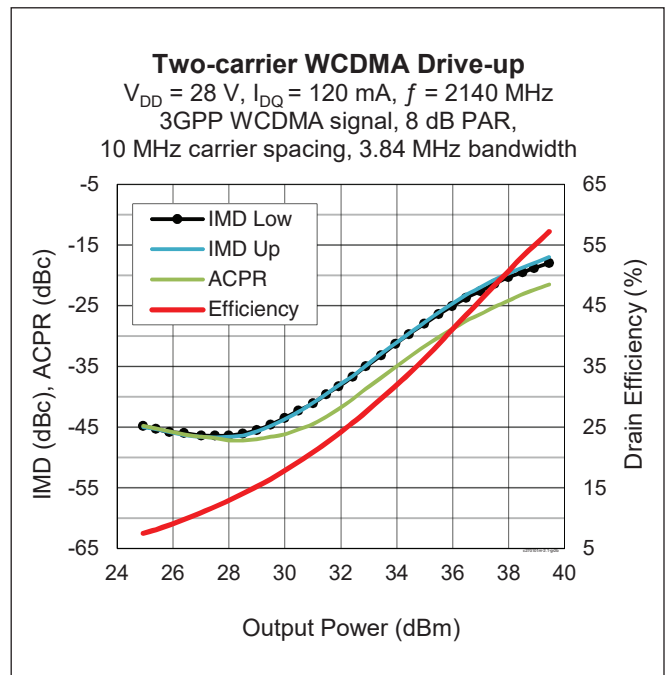
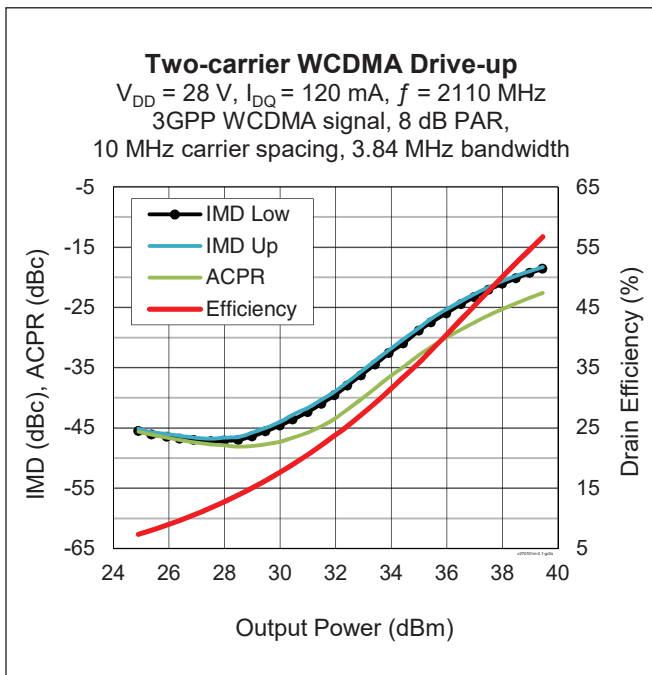
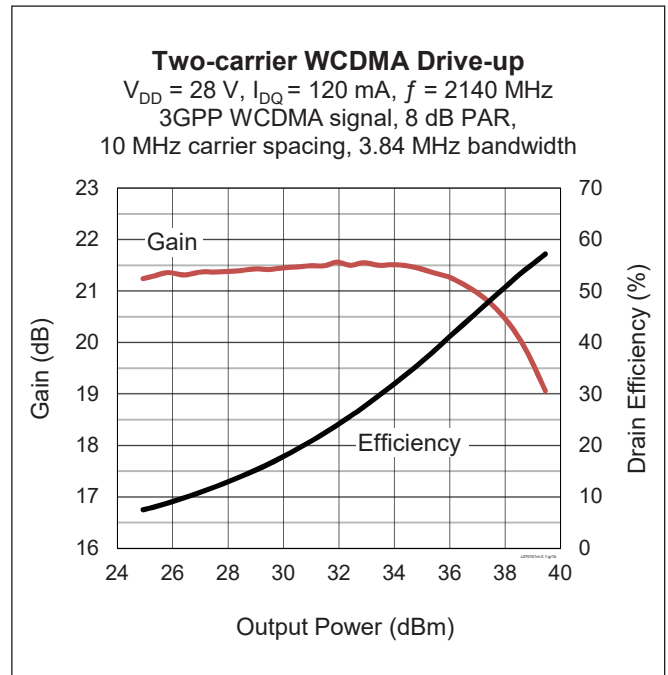
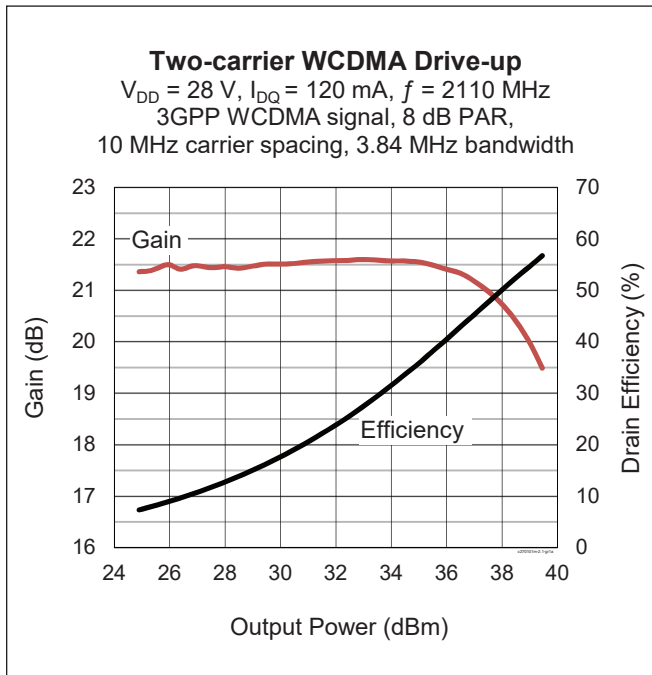

Typical RF Performance, 2110 – 2170 MHz (cont.)

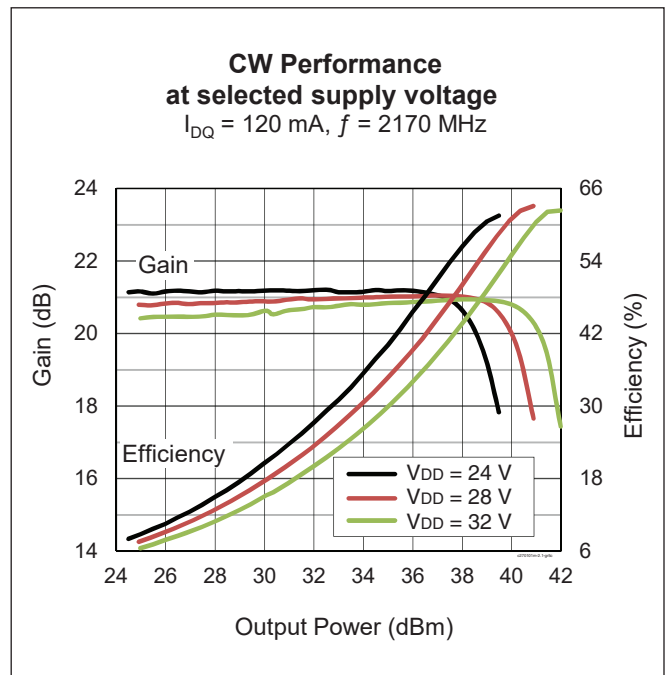
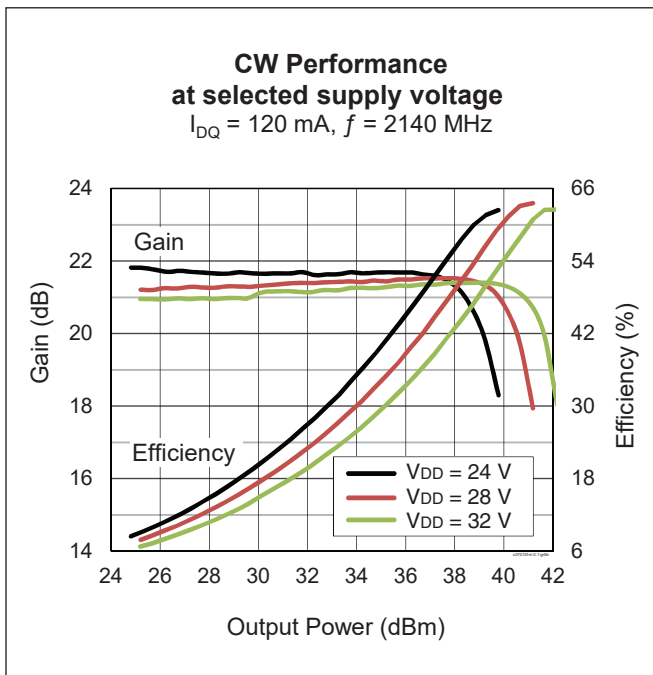
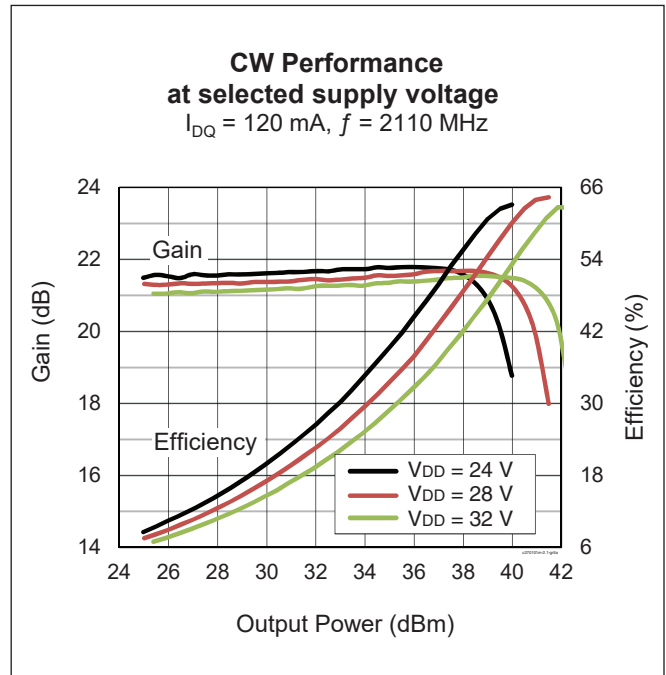
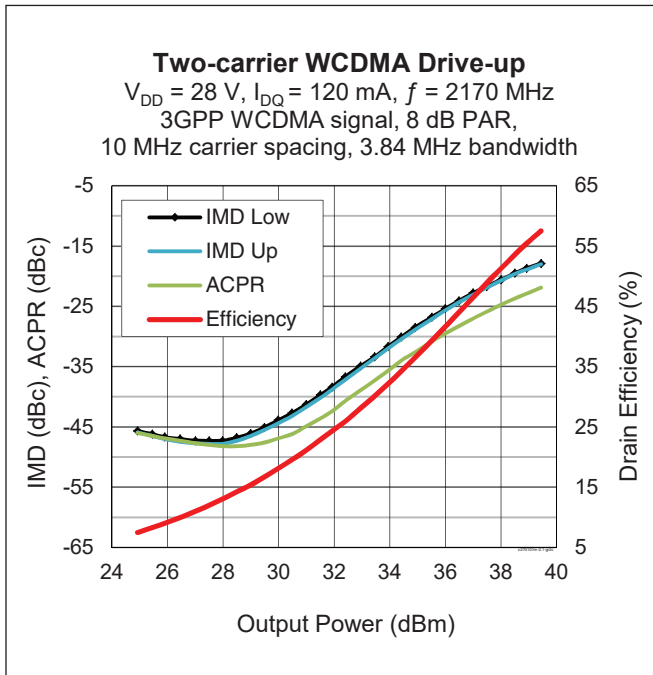

Typical RF Performance, 2110 – 2170 MHz (cont.)

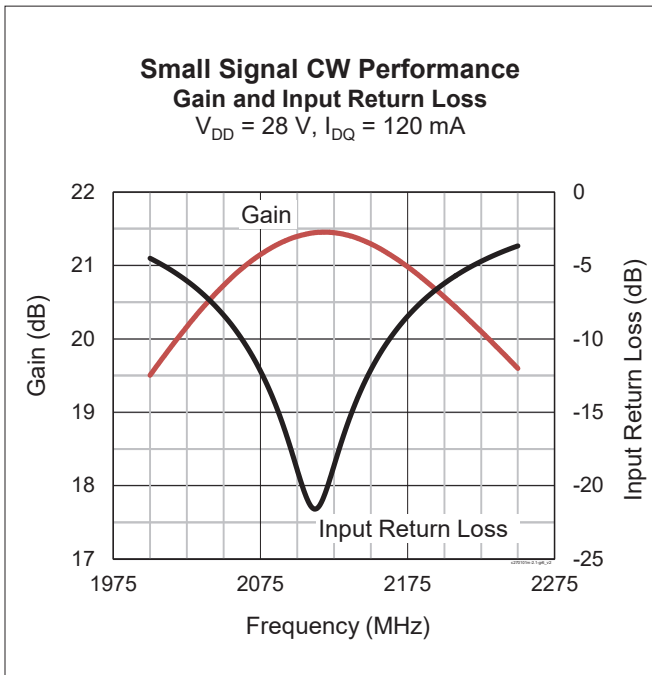
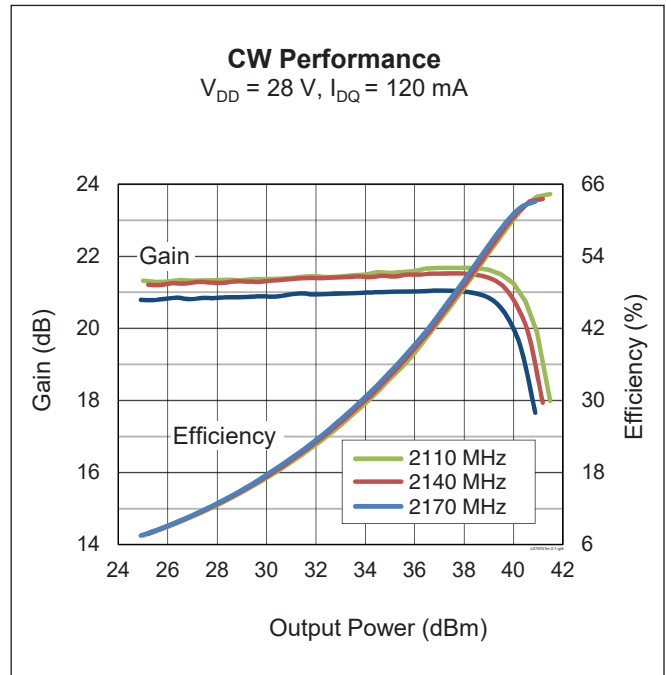
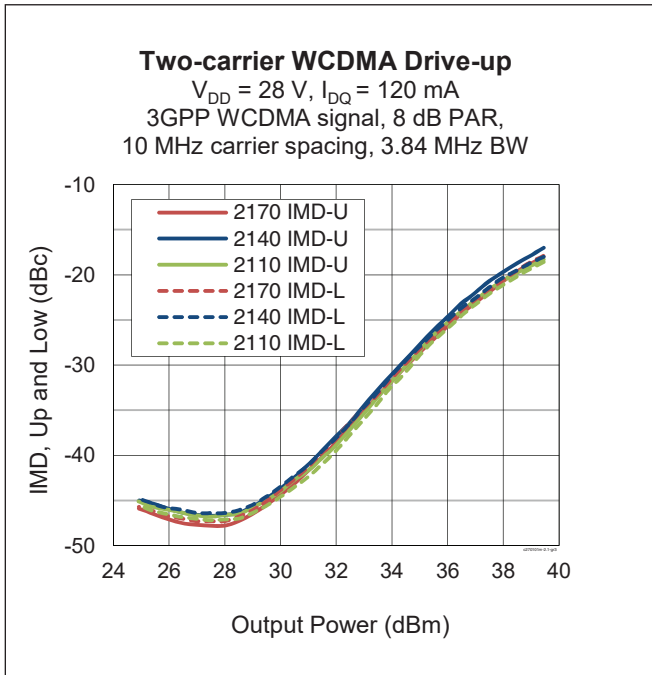

Broadband Circuit Impedance

Freq [MHz]	Z Source Ω		Z Load Ω	
	R	jX	R	jX
2110	2.1	-6.7	5.6	-6.1
2140	2.1	-6.5	5.6	-5.8
2170	2.1	-6.3	5.6	-5.5

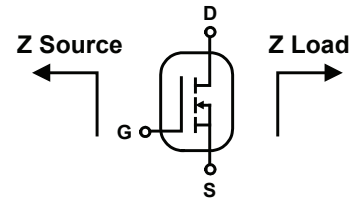

Load Pull Performance

Pulsed CW signal: 160 μ sec, 10% duty cycle; 28 V, 120 mA

Class AB		P_{1dB}									
		Max Output Power					Max PAE				
Freq [MHz]	Zs [Ω]	Zl [Ω]	Gain [dB]	POUT [dBm]	POUT [W]	PAE [%]	Zl [Ω]	Gain [dB]	POUT [dBm]	POUT [W]	PAE [%]
2110	2.1 - 6.1	7.15 - 7.2	19.4	42.06	16.07	59.5	4.8 - 4	21	40.81	12.05	66.8
2140	2.1 - 6.5	6.54 - 7.6	19.2	42.05	16.03	59.3	5.14 - 4.4	21	40.92	12.36	65.8
2170	2.1 - 6.6	7.2 - 7.9	19.3	41.93	15.6	58.2	5.2 - 4.8	21	40.84	12.13	64.6

Reference Circuit, 2100 MHz

DUT	PTFC270101M V1
Reference Circuit No.	LTN/PTFC270101M V1
Order Code	LTNPTFC270101MV1TOBO1
PCB	Rogers RO4350, 0.508 mm [.020"] thick, 2 oz. copper, $\epsilon_r = 3.66$

Find Gerber files for this reference fixture on the Wolfspeed Web site at www.wolfspeed.com/RF

Reference Circuit, 2100 MHz (cont.)

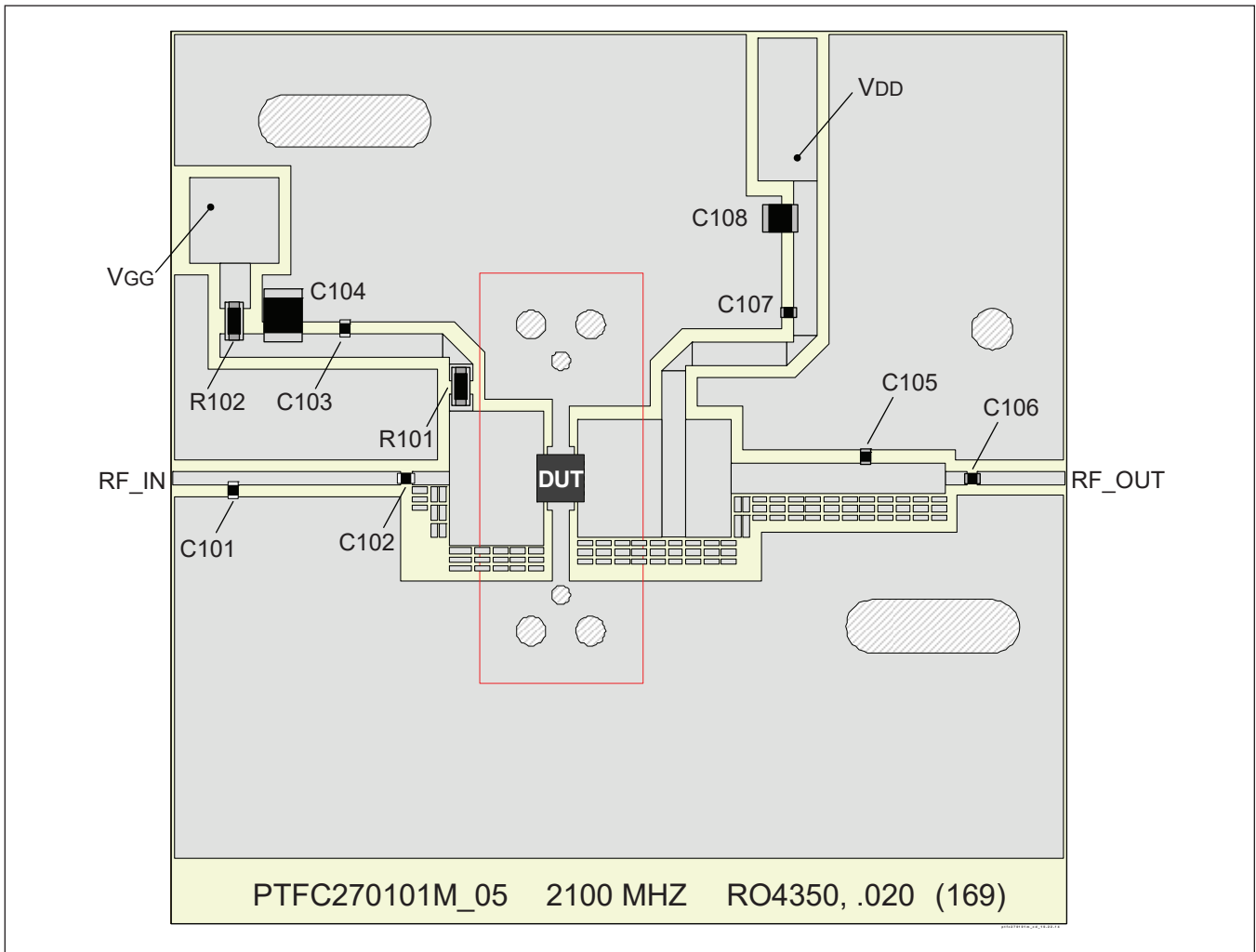

Assembly diagram for reference circuit LTN/PTFC270101M V1, 2100 MHz (not to scale)

Components Information

Component	Description	Manufacturer	P/N
C101	Capacitor, 1.5 pF	ATC	ATC600F1R5CW250
C102, C103, C106, C107	Capacitor, 12 pF	ATC	ATC600F120JW250
C104	Capacitor, 1.0 μ F	TDK Corporation	C4532X7R2A105M230KA
C105	Capacitor, 1.2 pF	ATC	ATC600F1R2CW250
C108	Capacitor, 10 μ F	Taiyo Yuden	UMK325C7106MM-T
R101, R102	Resistor, 10 ohms	Panasonic Electronic Components	ERJ-8GEYJ100V

RF Characteristics

Two-carrier WCDMA Characteristics (not subject to production test)

$V_{DD} = 28\text{ V}$, $I_{DQ} = 120\text{ mA}$, $P_{OUT} = 1.3\text{ W avg}$, $f_1 = 947.5\text{ MHz}$, $f_2 = 957.5\text{ MHz}$,
3GPP WCDMA signal, 3.84 MHz channel bandwidth, 8 dB peak/average @ 0.01% CCDF

Characteristic	Symbol	Min	Typ	Max	Unit
Gain	G_{ps}	—	23	—	dB
Drain Efficiency	η_D	—	20	—	%
Intermodulation Distortion	IMD	—	-39	—	dBc

Typical RF Performance, 920 – 960 MHz (data taken in production test fixture)

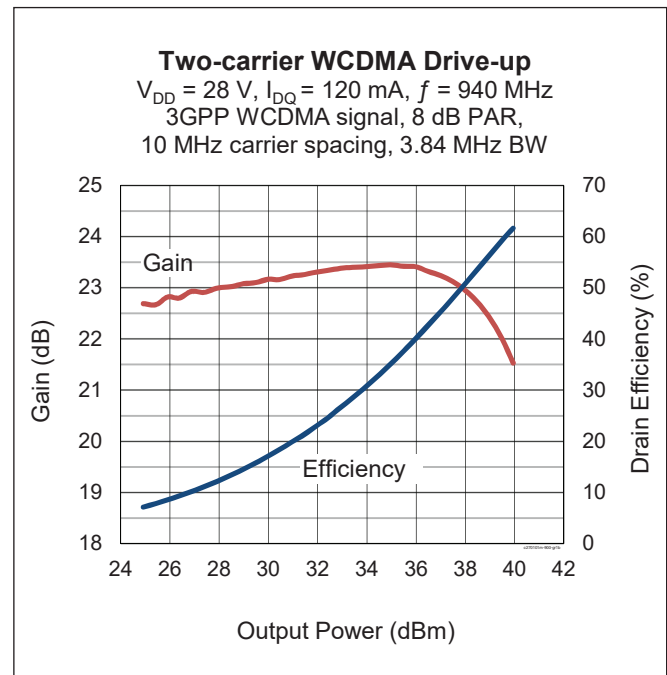
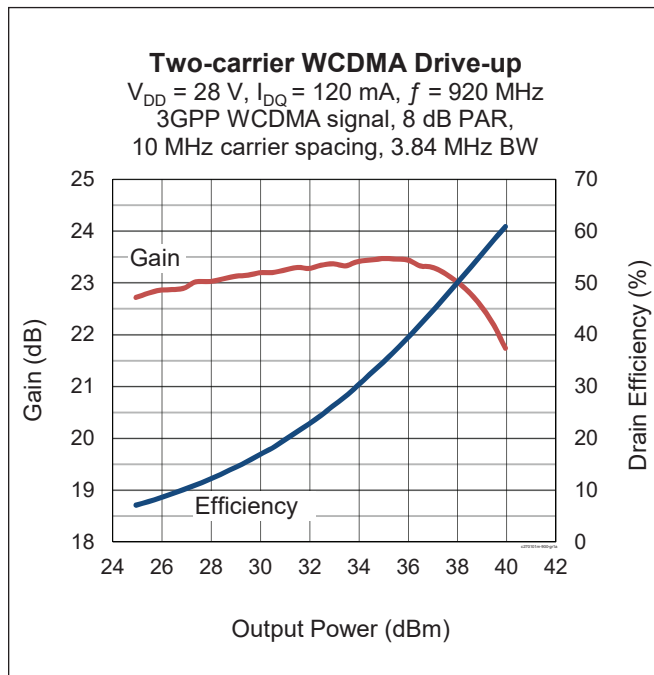

Typical RF Performance, 920 – 960 MHz (cont.)

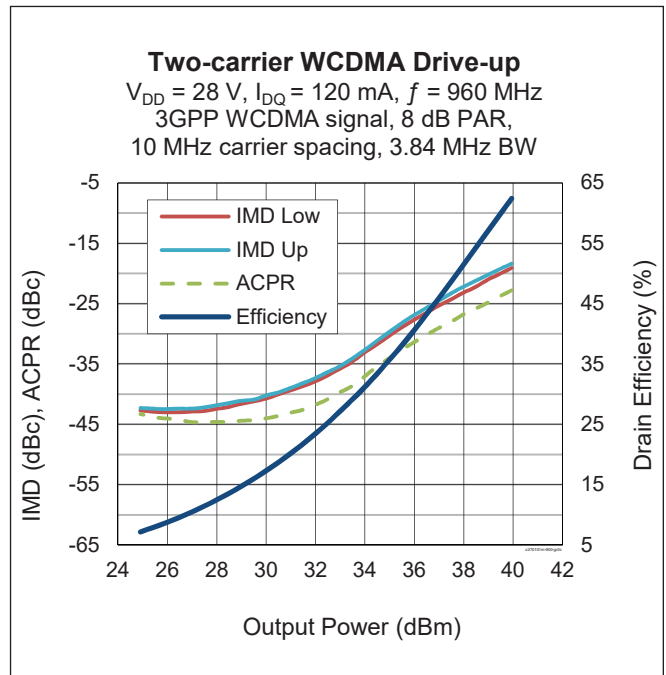
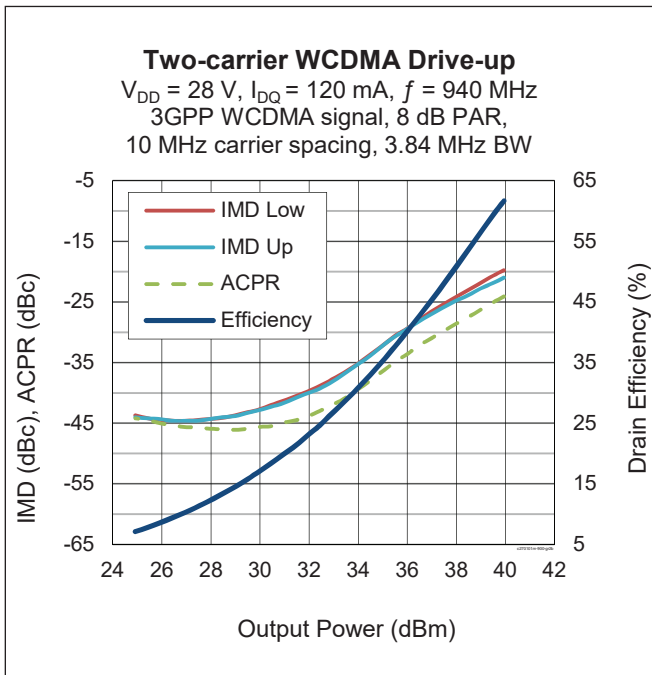
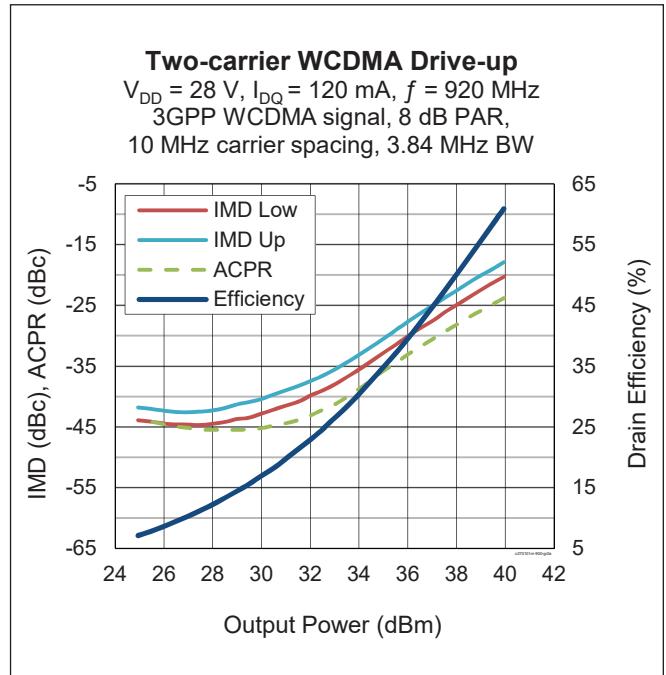
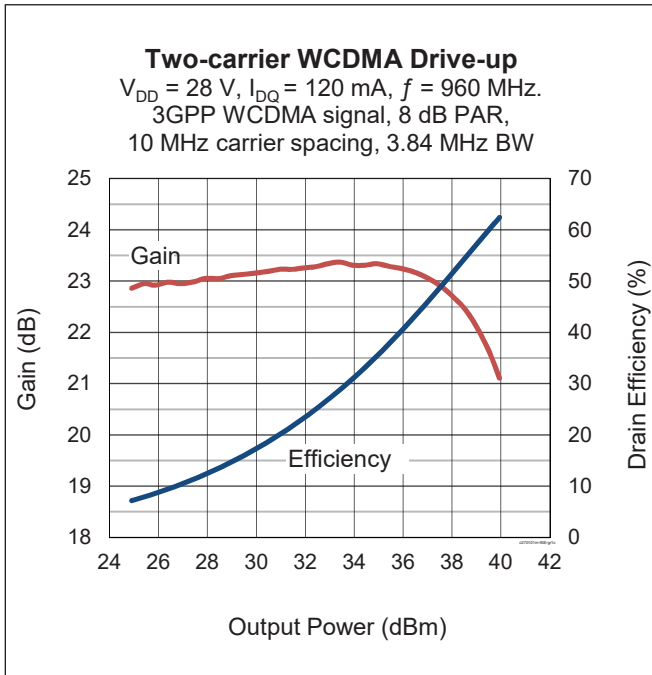

Typical RF Performance, 920 – 960 MHz (cont.)

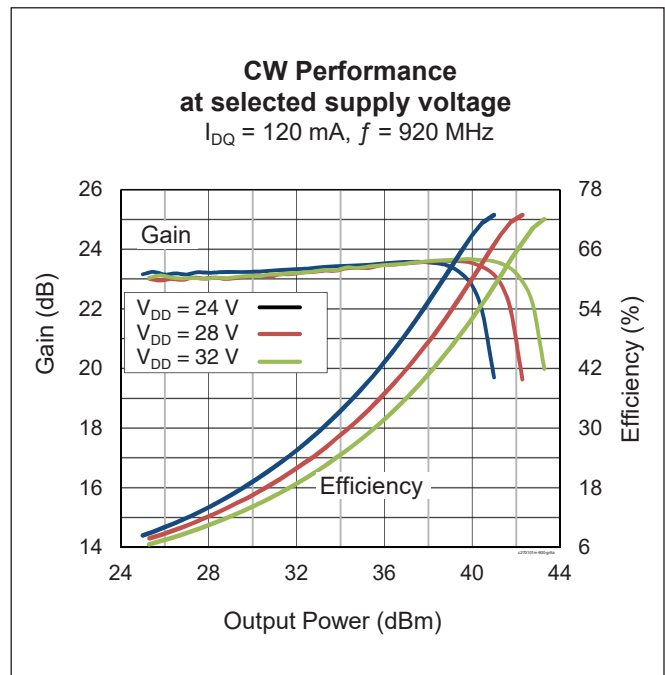
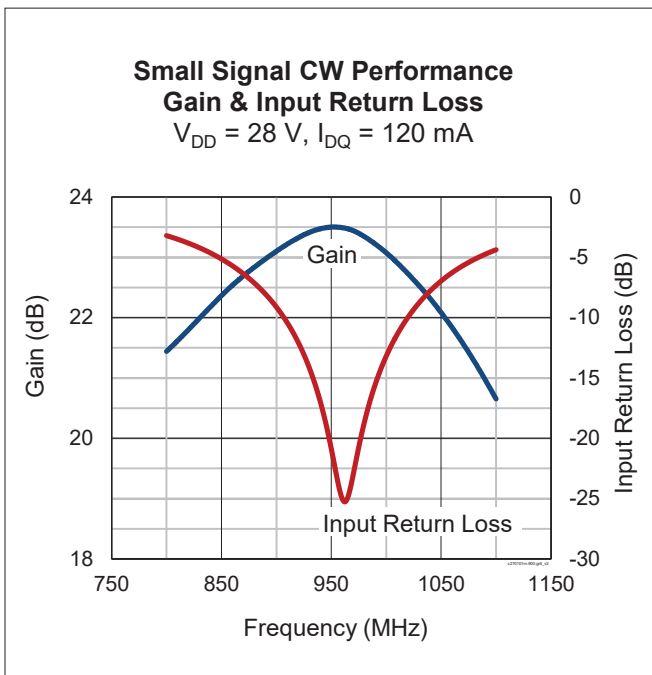
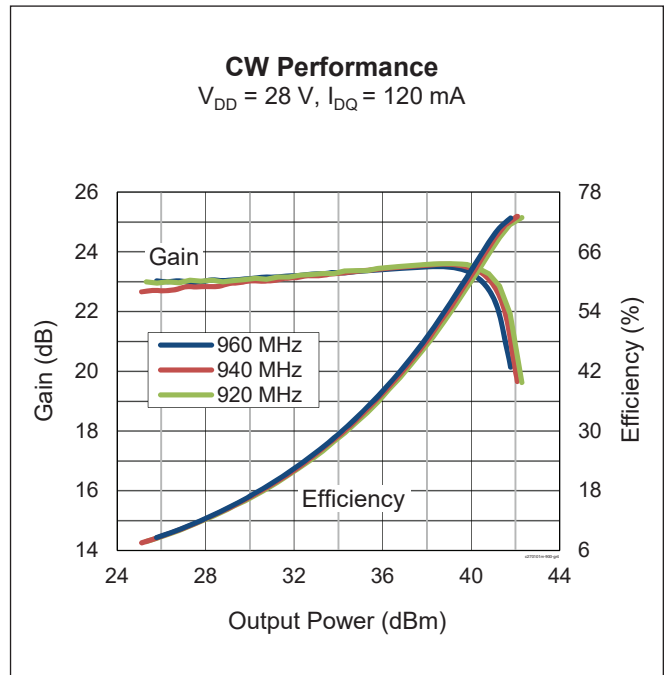
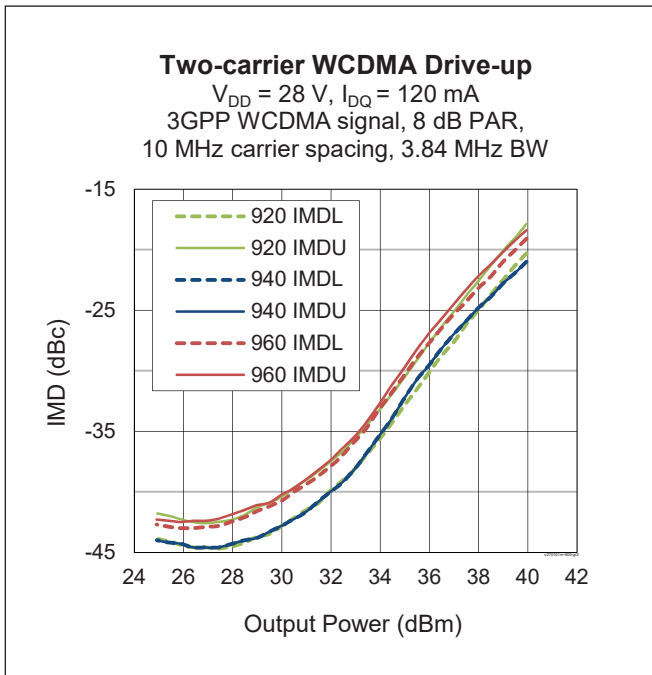

Typical RF Performance, 920 – 960 MHz (cont.)

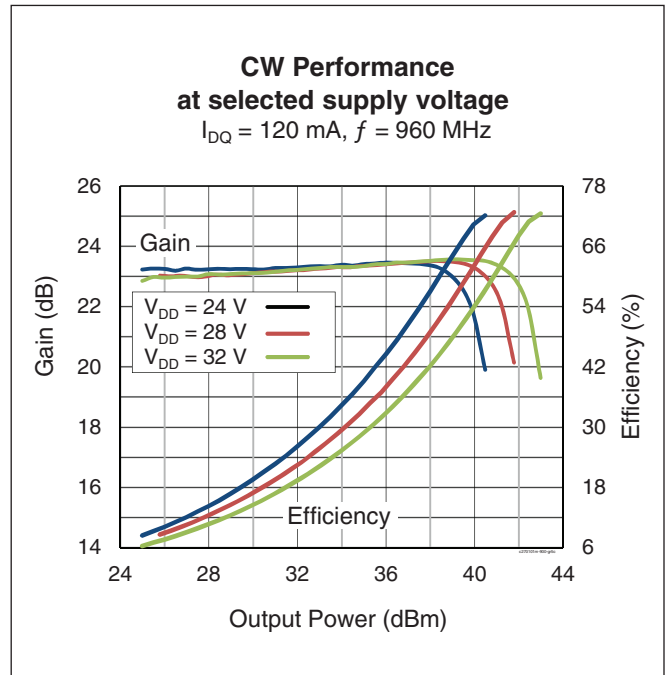
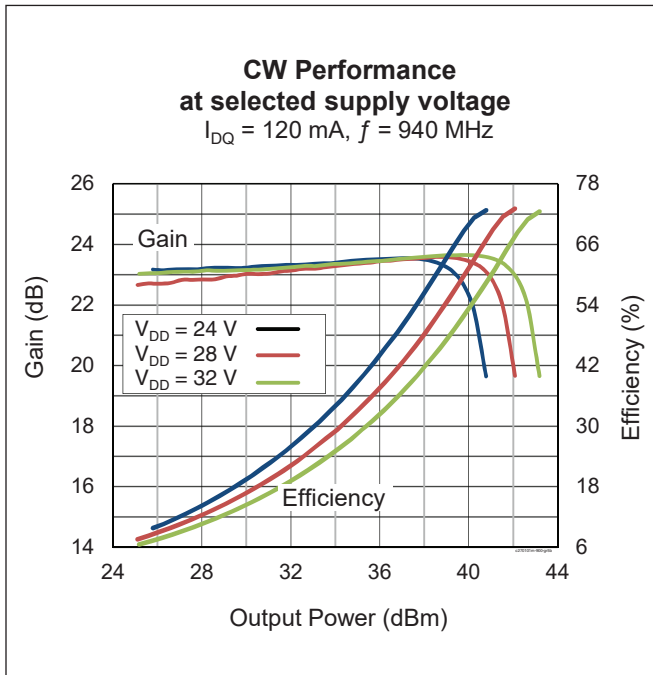

Broadband Circuit Impedance

Freq [MHz]	Z Source Ω		Z Load Ω	
	R	jX	R	jX
920	2.5	3.8	16.3	3.0
940	2.5	4.0	16.3	3.2
960	2.5	4.3	16.3	3.4

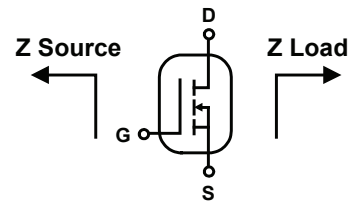

Load Pull Performance

Pulsed CW signal: 160 μ sec, 10% duty cycle; 28 V, 120 mA

Class AB		P _{1dB}									
		Max Output Power					Max PAE				
Freq [MHz]	Z _s [Ω]	Z _l [Ω]	Gain [dB]	P _{OUT} [dBm]	P _{OUT} [W]	PAE [%]	Z _l [Ω]	Gain [dB]	P _{OUT} [dBm]	P _{OUT} [W]	PAE [%]
920	2.02 + j3.96	13.8 - j1.0	24.0	42.3	16.98	62.3	15.7 + j8.1	26.0	40.7	11.75	70.1
940	2.78 + j4.60	15.2 - j2.1	23.7	42.1	16.22	60.5	17.5 + j8.4	25.7	40.3	10.72	67.8
960	2.22 + j3.69	16.1 - j3.3	23.4	42.2	16.6	57.7	16.5 + j8.1	25.7	40.3	10.72	65.8

Reference Circuit, 900 MHz

DUT	PTFC270101M V1
Reference Circuit No.	LTN/PTFC270101M E4
Order Code	LTNPTFC270101ME4TOBO1
PCB	Rogers RO4350, 0.508 mm [.020"] thick, 2 oz. copper, $\epsilon_r = 3.66$
Find Gerber files for this reference fixture on the Wolfspeed Web site at www.wolfspeed.com/RF	

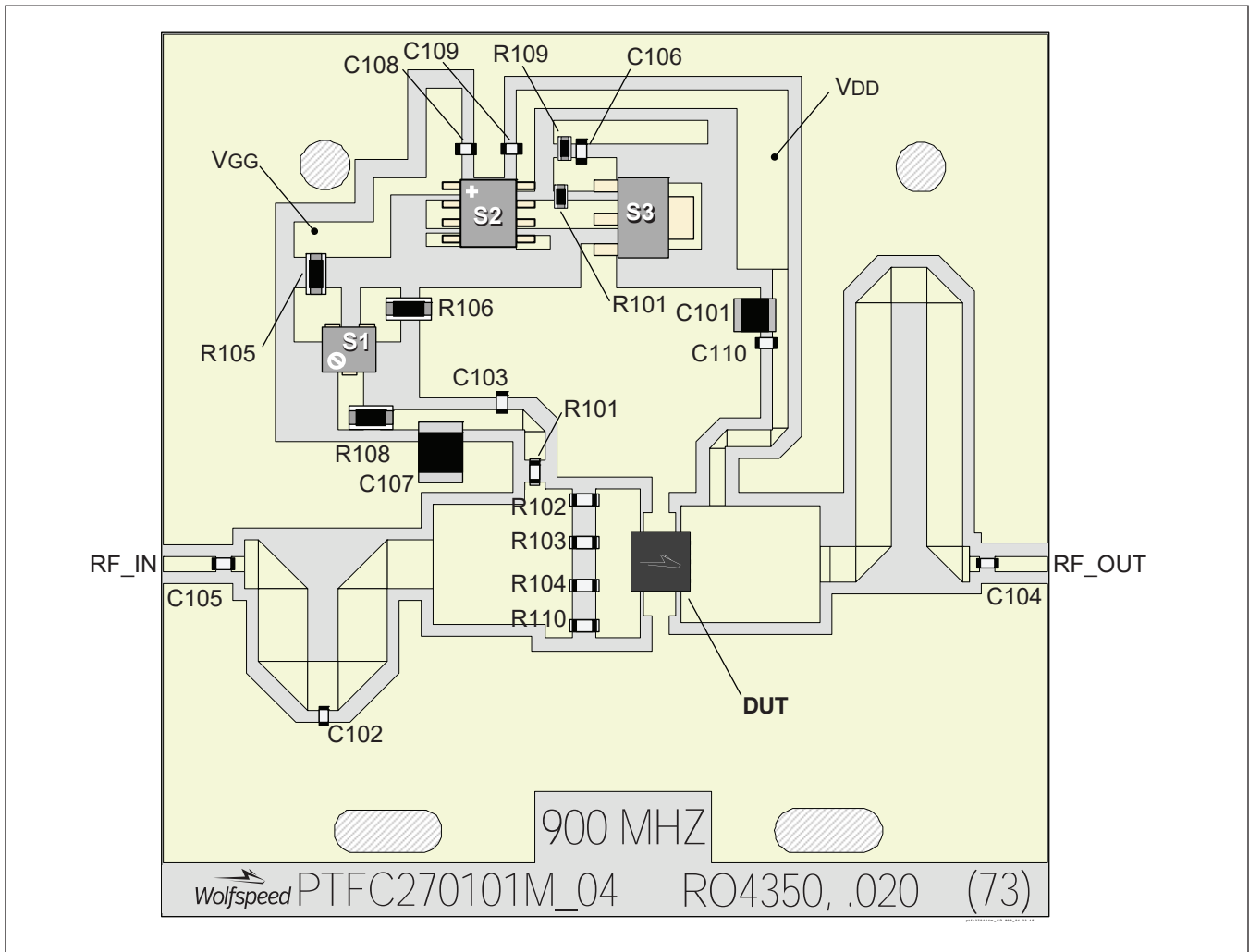

Assembly diagram for reference circuit LTN/PTFC270101M E4, 900 MHz (not to scale)

Reference Circuit, 900 MHz (cont.)**Components Information**

Component	Description	Manufacturer	P/N
C101	Capacitor, 10 μ F	Taiyo Yuden	UMK325C7106MM-T
C102	Capacitor, 5.6 pF	ATC	ATC600F5R6JW250
C103, C104 C105, C110	Capacitor, 56 pF	ATC	ATC100A560JW250
C106, C108, C109	Capacitor, .001 μ F	Panasonic	ECJ-1VB1H102K
C107	Capacitor, 2.2 μ F	TDK Corporation	C3225X7R1H225K250AB
R101, R102, R103, R104, R110	Resistor, 10 ohms	Panasonic – ECG	ERJ-3GEYJ100V
R105, R108	Resistor, 10 ohms	Panasonic Electronic Components	ERJ-8GEYJ100V
R106	Resistor, 1.1K ohms	Panasonic Electronic Components	ERJ-8GEYJ112V
R107	Resistor, 1.2K ohms	Panasonic Electronic Components	ERJ-3GEYJ122V
R109	Resistor, 1.3K ohms	Panasonic Electronic Components	ERJ-3GEYJ132V
S1	Potentiometer, 2k ohms	Bourns Inc.	3224W-1-202E
S2	Voltage Regulator	Texas Instruments	LM78L05ACM
S3	Transistor	Infineon Technologies	BCP56-10

See next page for 2600 MHz operation

RF Characteristics

Two-carrier WCDMA Characteristics (not subject to production test)

$V_{DD} = 28\text{ V}$, $I_{DQ} = 120\text{ mA}$, $P_{OUT} = 1.3\text{ W avg}$, $f_1 = 2650\text{ MHz}$, $f_2 = 2660\text{ MHz}$,
 3GPP WCDMA signal, 3.84 MHz channel bandwidth, 8 dB peak/average @ 0.01% CCDF

Characteristic	Symbol	Min	Typ	Max	Unit
Gain	G_{ps}	—	18.2	—	dB
Drain Efficiency	η_D	—	19.7	—	%
Intermodulation Distortion	IMD	—	-45	—	dBc

Typical RF Performance, 2620 – 2690 MHz (data taken in production test fixture)

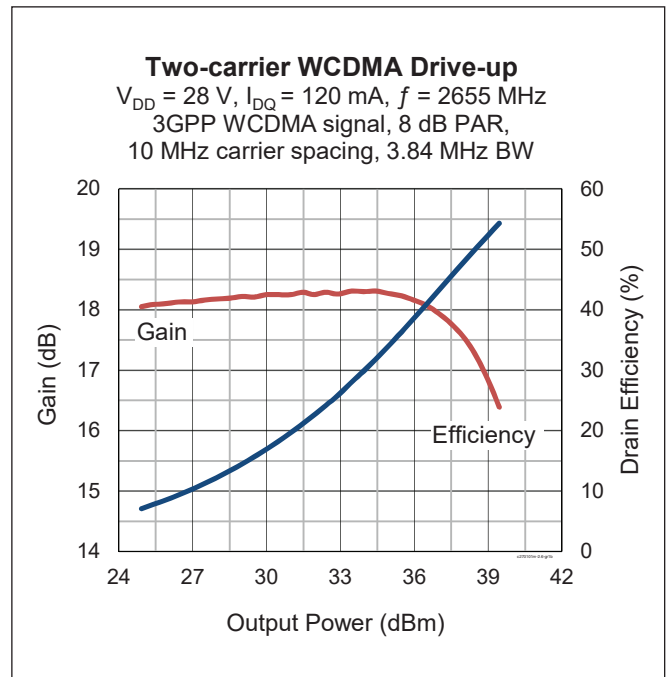
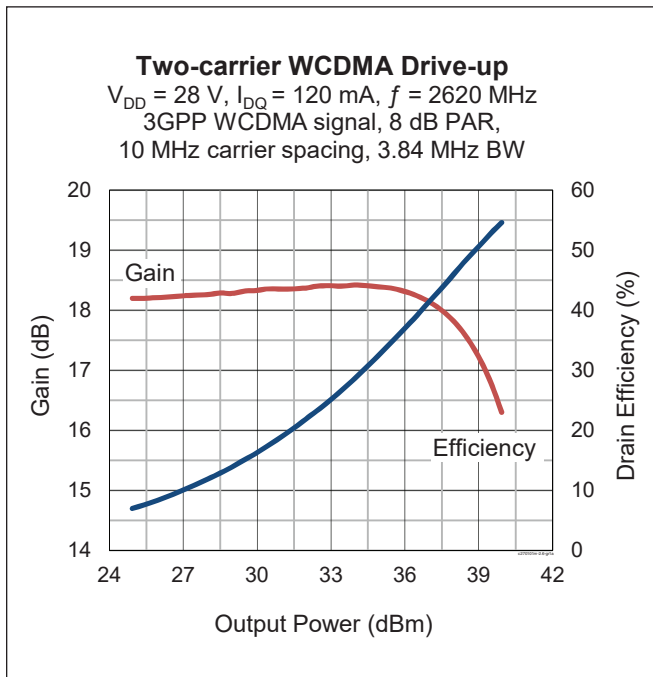

Typical RF Performance, 2620 – 2690 MHz (cont.)

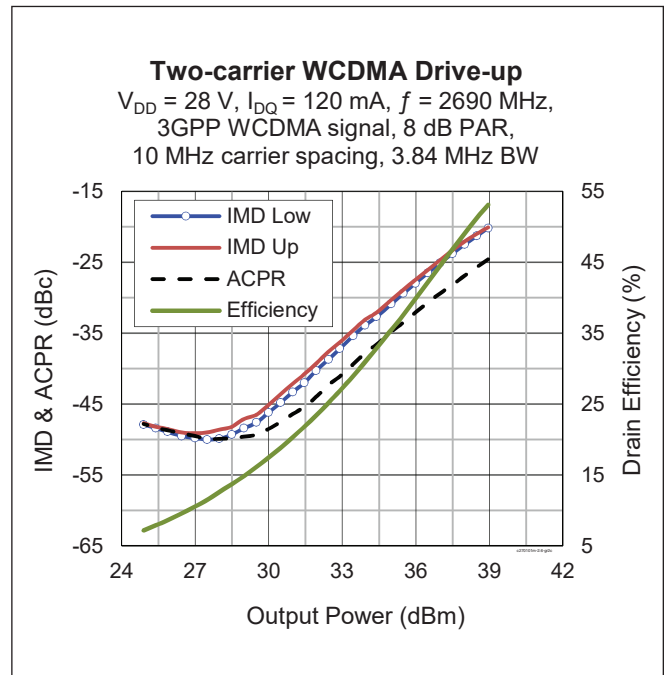
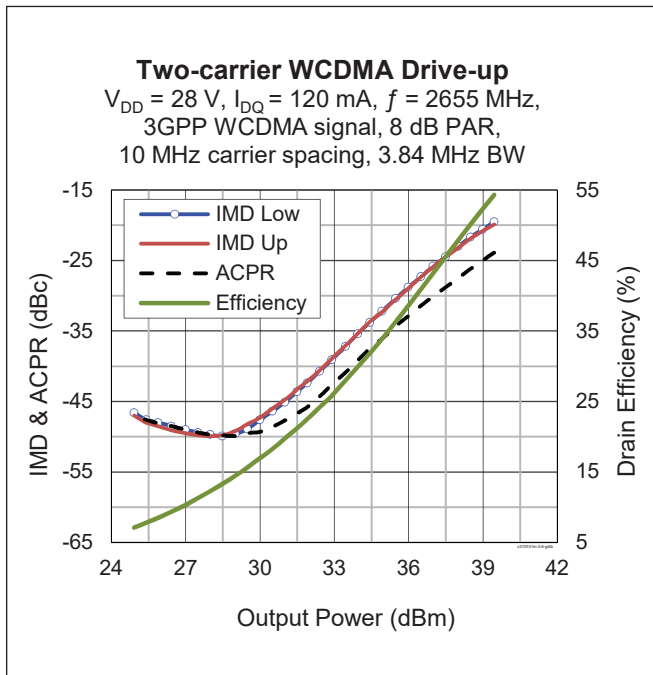
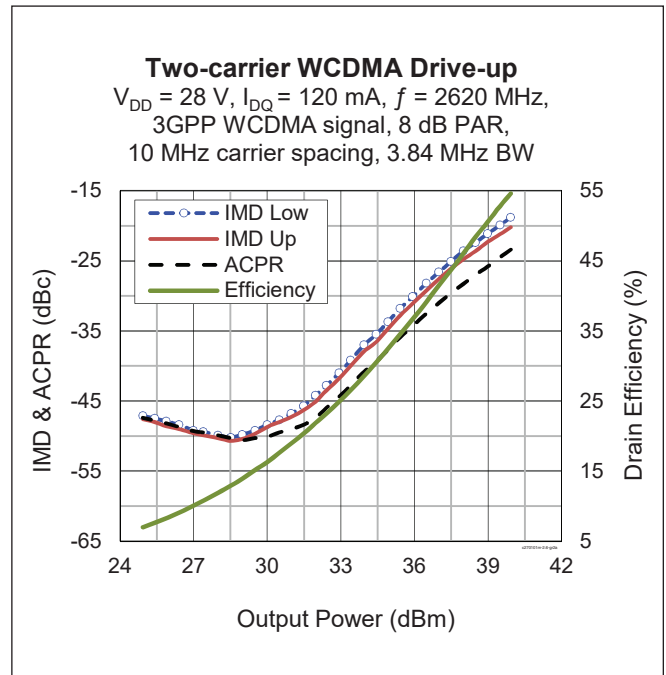
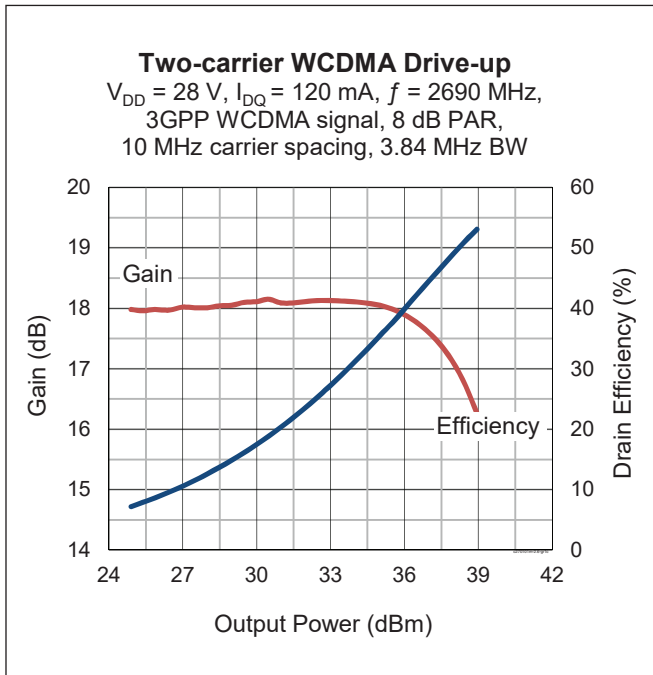

Typical RF Performance, 2620 – 2690 MHz (cont.)

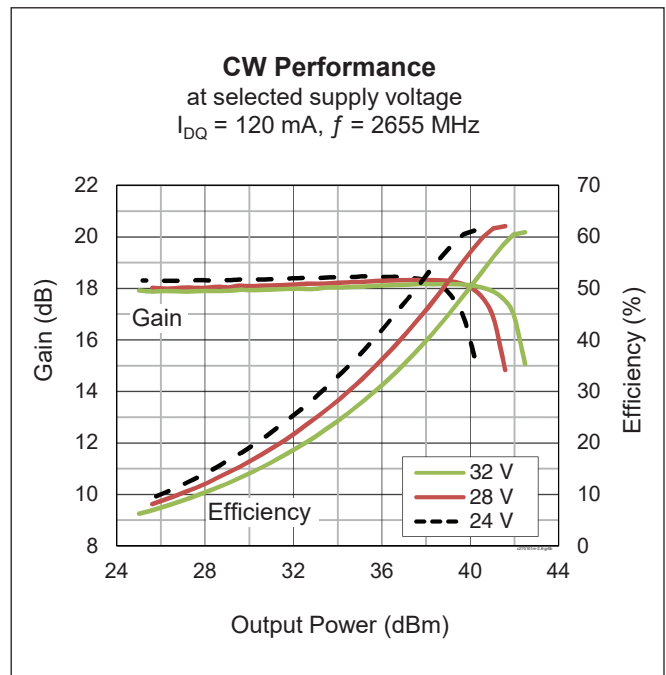
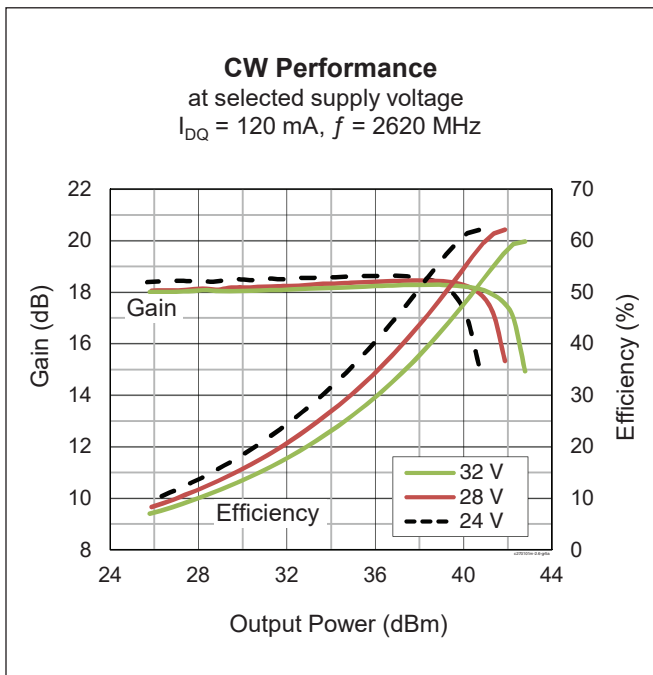
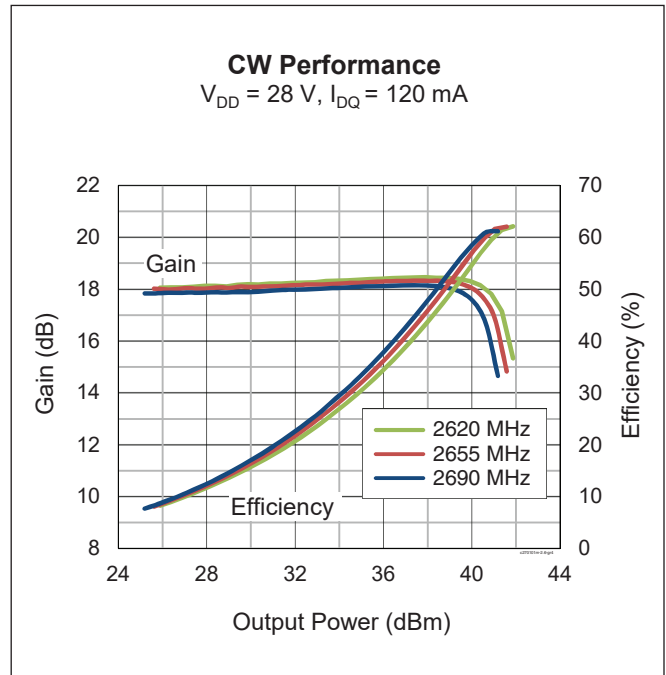
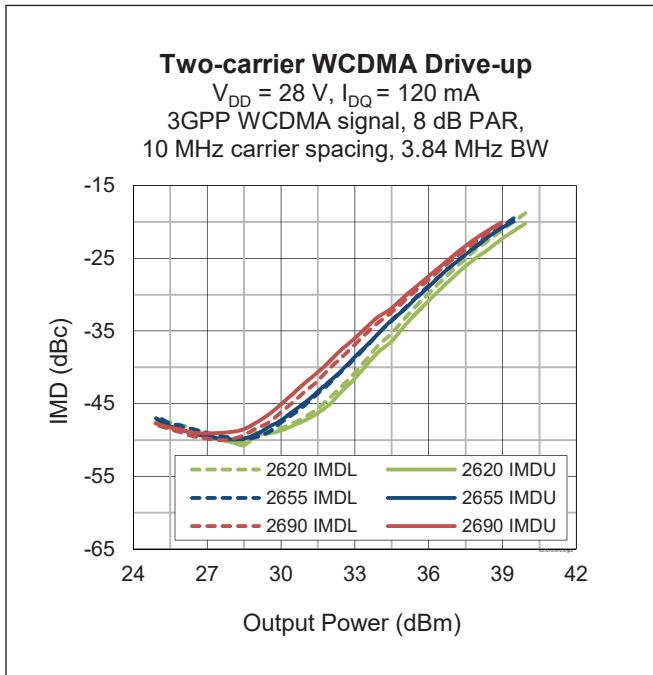

Typical RF Performance, 2620 – 2690 MHz (cont.)

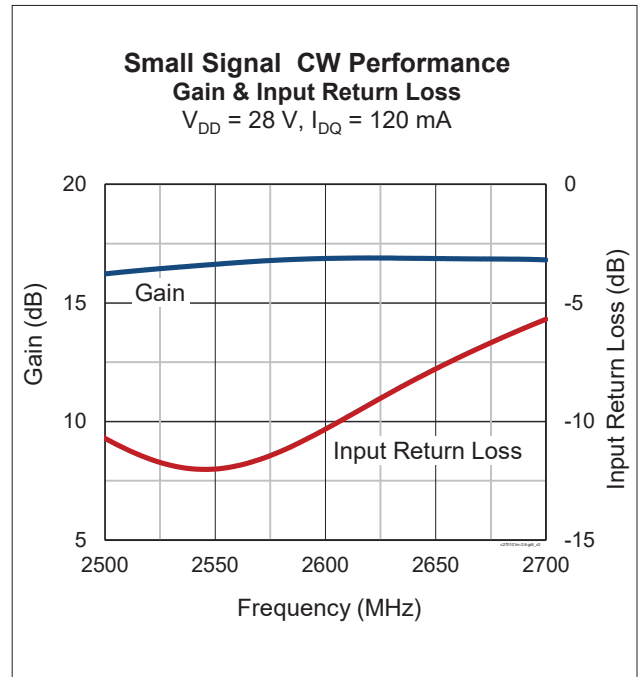
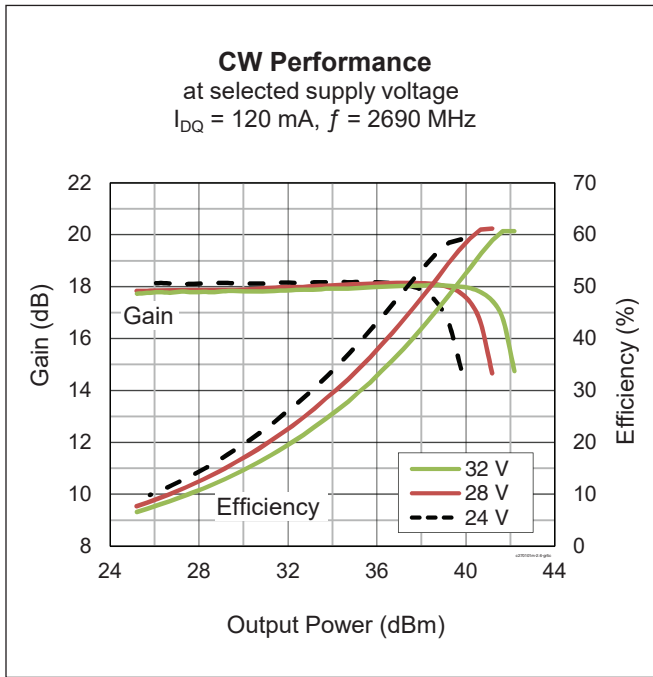

Broadband Circuit Impedance

Freq [MHz]	Z Source Ω		Z Load Ω	
	R	jX	R	jX
2620	2.2	-8.4	5.0	-12.4
2655	2.2	-8.2	5.0	-12.1
2690	2.2	-8.0	5.0	-11.8

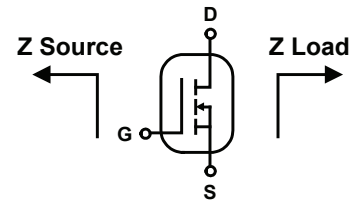

Load Pull Performance

Pulsed CW signal: 160 μsec , 10% duty cycle; 28 V, 120 mA

Class AB		P_{1dB}									
		Max Output Power					Max PAE				
Freq [MHz]	Zs [Ω]	Zl [Ω]	Gain [dB]	P _{OUT} [dBm]	P _{OUT} [W]	PAE [%]	Zl [Ω]	Gain [dB]	P _{OUT} [dBm]	P _{OUT} [W]	PAE [%]
2620	2.1 - j7.9	6.35 - j13	17.6	41.48	14.06	55.6	4.35 - j10.8	19.2	40.5	11.22	61.68
2655	2.2 - j8.2	5.93 - j13.2	17.4	41.46	14	54.7	4 - j11	19.1	40.43	11.04	60.8
2690	2.3 - j8.1	5.04 - j13.6	16.5	41.4	13.8	54.5	3.54 - j11.5	18.71	40.21	10.5	61.23

Reference Circuit, 2620 – 2690 MHz

DUT	PTFC270101M V1
Reference Circuit No.	LTN/PTFC270101M E3
Order Code	LTNPTFC270101ME3TOBO1
PCB	Rogers RO4350, 0.508 mm [.020"] thick, 2 oz. copper, $\epsilon_r = 3.66$
Find Gerber files for this reference fixture on the Wolfspeed Web site at www.wolfspeed.com/RF	

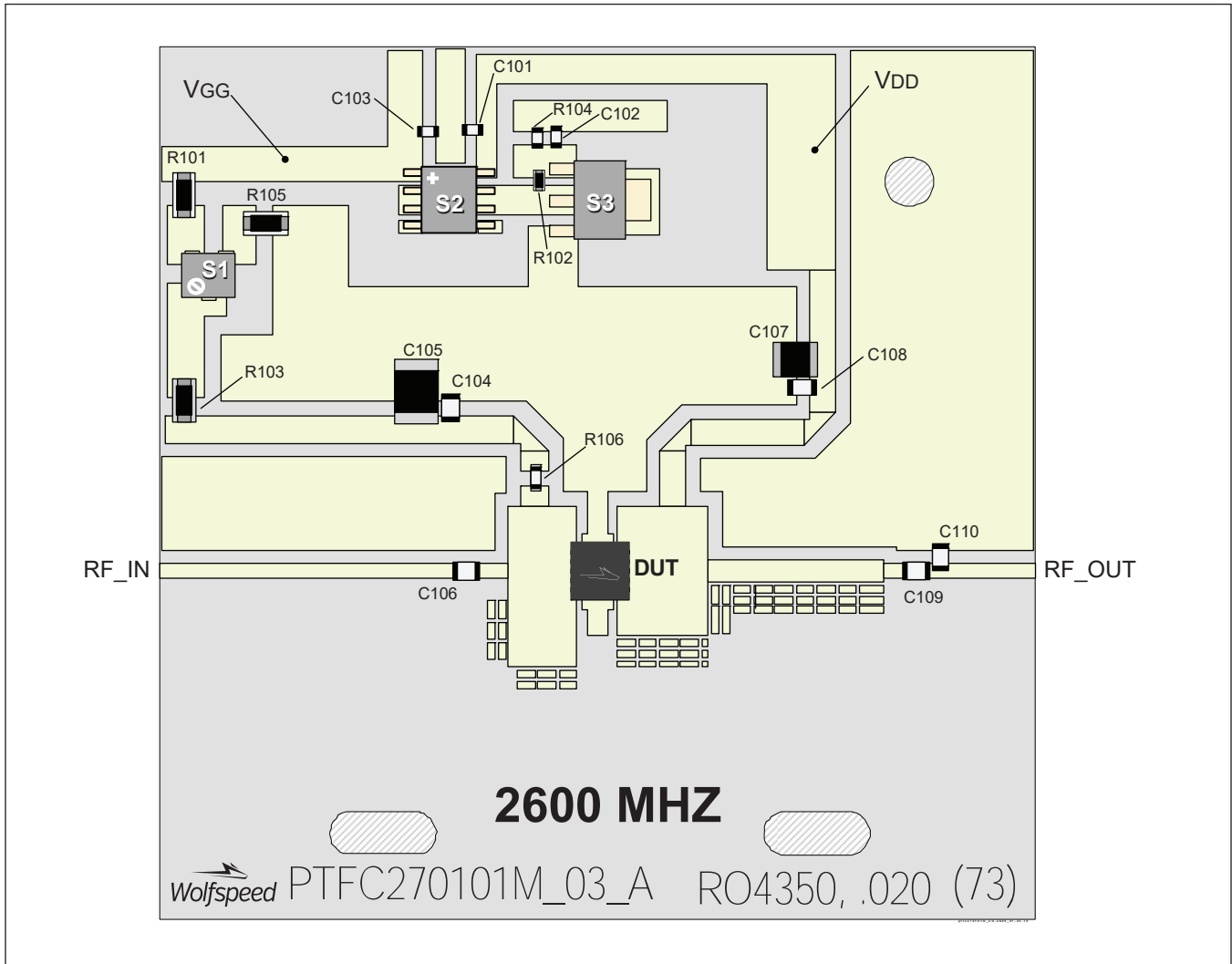

Assembly diagram for reference circuit LTN/PTFC270101M E3, 2600 MHz (not to scale)

Reference Circuit, 2620 – 2690 MHz (cont.)**Components Information**

Component	Description	Manufacturer	P/N
C101, C102, C103	Capacitor, 0.001 μ F	Panasonic	ECJ-1VB1H102K
C104, C108, C109	Capacitor, 12 pF	ATC	ATC600S120JW250
C105	Capacitor, 2.2 μ F	TDK Corporation	C3225X7R1H225K250AB
C106	Capacitor, 1 pF	ATC	ATC600S1R0CW250
C107	Capacitor, 10 μ F	Taiyo Yuden	UMK325C7106MM-T
C110	Capacitor, 0.3 pF	ATC	ATC600S0R3CW250
R101, R103	Resistor, 10 ohms	Panasonic Electronic Components	ERJ-8GEYJ100V
R102	Resistor, 1.2K ohms	Panasonic Electronic Components	ERJ-3GEYJ122V
R104	Resistor, 1.3K ohms	Panasonic Electronic Components	ERJ-3GEYJ132V
R105	Resistor, 470 ohms	Panasonic Electronic Components	ERJ-8GEYJ471V
R106	Resistor, 10 ohms	Panasonic Electronic Components	ERJ-3GEYJ100V
S1	Potentiometer, 2k ohms	Bourns Inc.	3224W-1-202E
S2	Voltage Regulator	Texas Instruments	LM78L05ACM
S3	Transistor	Infineon Technologies	BCP56-10

Package Outline Specifications

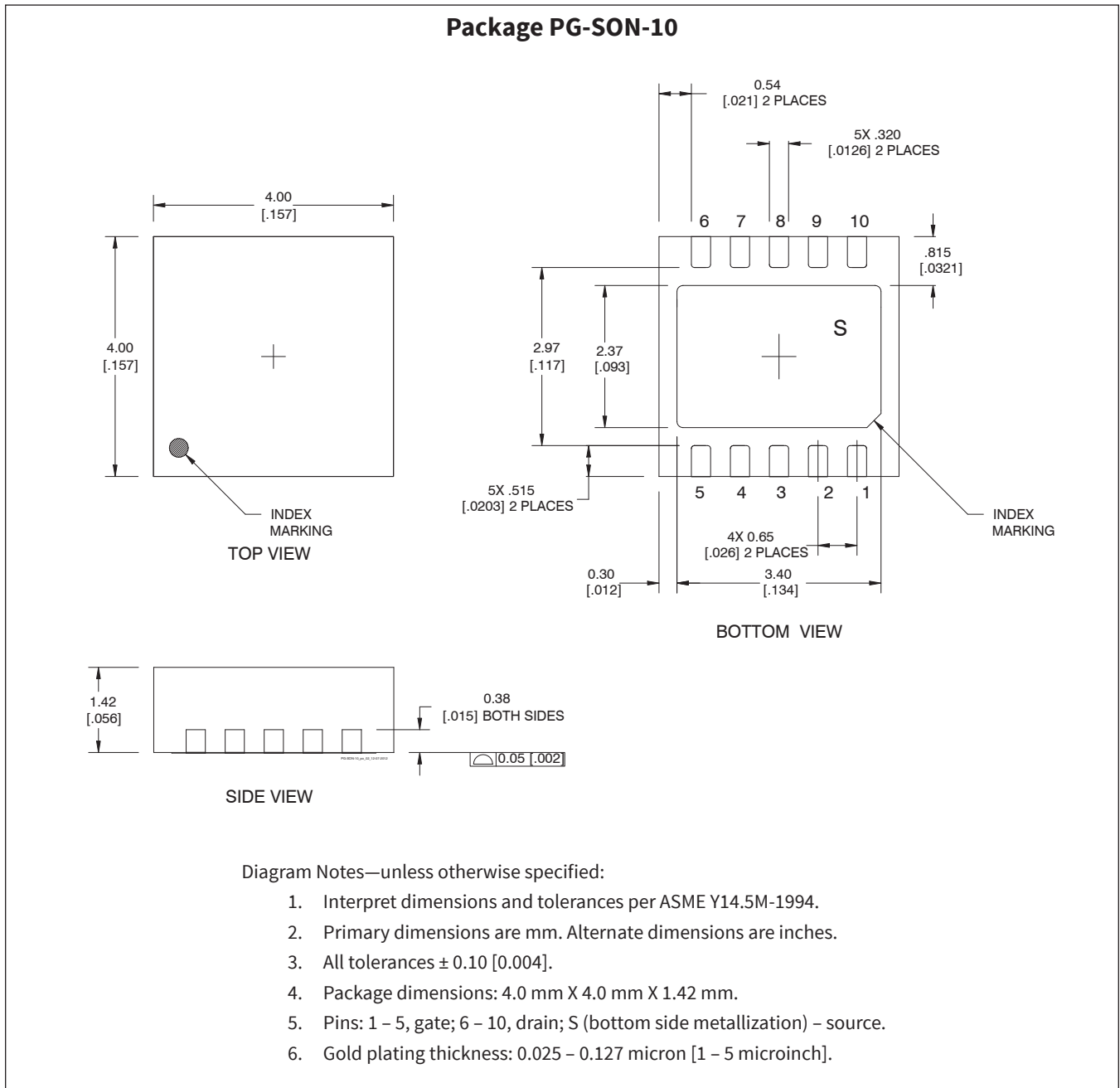

Revision History

Revision	Date	Data Sheet Type	Page	Subjects (major changes since last revision)
01	2013-03-05	Advance	All	Proposed specification for new product development.
02	2013-06-10	Advance	2	Lower maximum junction temperature spec, add thermal resistance.
02.1	2013-06-25	Advance	2	Rev. 02.1 reverts junction temperature back to 200°C
03	2014-12-17	Production	All 2 2	Complete production-released product information, including typical performance graphs and reference circuits for 2100 MHz, 900 MHz and 2600 MHz operation. Maximum Operating Voltage added, maximum V_{GS} revised. Maximum junction temperature raised to 225 °C. ESD ratings clarified.
04	2015-04-01	Production	5, 10, 17	Corrected IDQ in Small Signal CW Performance graphs
04.1	2016-07-26	Production	3	Add ordering information for additional evaluation boards.
04.2	2016-12-15	Production	2	Updated HBM classification to 1B
05	2018-06-20	Production	All	Converted to Wolfspeed Data Sheet
05.1	2020-10-15	Production	3	Updated evaluation boards table

For more information, please contact:

4600 Silicon Drive
Durham, North Carolina, USA 27703
www.wolfspeed.com/rf

Sales Contact
rfsales@cree.com

Notes & Disclaimer

Specifications are subject to change without notice. “Typical” parameters are the average values expected by Cree in large quantities and are provided for information purposes only. Cree products are not warranted or authorized for use as critical components in medical, life-saving, or life-sustaining applications, or other applications where a failure would reasonably be expected to cause severe personal injury or death. No responsibility is assumed by Cree for any infringement of patents or other rights of third parties which may result from use of the information contained herein. No license is granted by implication or otherwise under any patent or patent rights of Cree.

© 2020 Cree, Inc. All rights reserved. Wolfspeed® and the Wolfspeed logo are registered trademarks of Cree, Inc.