

**Photovoltaic Isolator
 Solid-State
 Opto-Isolated MOSFET Gate Driver
 Dual-Channel, 5V, 1.0μA**

General Description

The PVI5013R Photovoltaic Isolator is a dual-channel, opto-isolated driver capable of directly driving gates of power MOSFETs or IGBTs. It utilizes a monolithic integrated circuit photovoltaic generator of novel construction as its output. The output is controlled by radiation from a GaAlAs light emitting diode (LED) which is optically isolated from the photovoltaic generator.

The PVI5013R is ideally suited for applications requiring high-current and/or high voltage switching with optical isolation between the low-level driving circuitry and high-energy or high-voltage load circuits. It can be used for directly driving gates of power MOSFETs. The dual-channel configuration allows its outputs to drive independent discrete power MOSFETs, or be connected in parallel or in series to provide higher-current drive for power MOSFETs or higher-voltage drive for IGBTs. PVI5013R employs a fast turn-off circuitry.

PVI5013R Photovoltaic Isolators are packaged in an 8-pin, molded DIP package with either thru-hole or surface-mount (gull-wing) terminals. It is available in standard plastic shipping tubes or on tape-and-reel. Please refer to Part Identification information opposite.

Features

- Monolithic construction
- 3,750 V_{RMS} I/O Isolation
- 1,200 V_{DC} output-to-output isolation
- Dual-Channel application flexibility
- Solid-State reliability
- UL recognized and BABT Certified

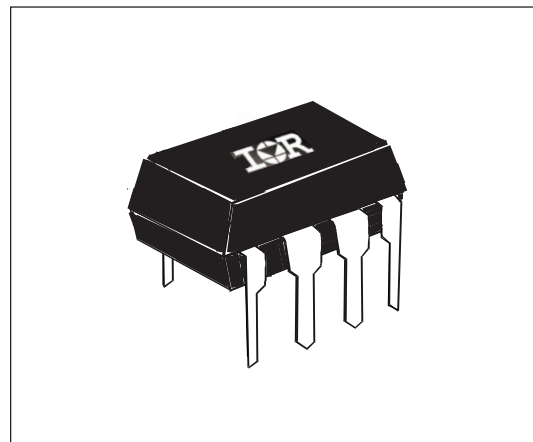

Applications

- Telecommunications
- Load Distribution
- Industrial Controls
- Instrumentation and Measurement

Part Identification

PVI5013RPbF	thru-hole
PVI5013RSPbF	surface-mount
PVI5013RS-TPbF	surface-mount, Tape and Reel

Electrical Specifications (-40°C ≤ T_A ≤ +85°C unless otherwise specified)

INPUT CHARACTERISTICS	Limits	Units
Minimum Input Current (see figure 1)	5.0	mA
Input Current Range (see figure 1)	3.0 to 25	mA
Maximum Continuous Input Current @ T _A =+25°C	40	mA
LED Forward Voltage Drop @ 5mA, T _A =+25°C (see figure 3)	1.4	V
Maximum Reverse Voltage	6.0	V
Maximum Reverse Current @ -6V _{DC} , T _A =+25°C	10	μA

OUTPUT CHARACTERISTICS	Limits	Units
Minimum Forward Voltage	8.0	V _{DC}
Maximum Reverse Current	10	μA _{DC}

COUPLED CHARACTERISTICS	Limits	Units
Minimum Output Voltage @ I _{LED} = 5mA, R _L = 10MΩ @ T _A =0°C to +70°C (see figures 1 and 2)	3	V
Maximum Output Voltage @ I _{LED} = 5mA, R _L = 10MΩ @ T _A =0°C to +70°C (see figures 1 and 2)	8	V
Maximum Voltage Differential Between Outputs @ I _{LED} = 5mA, R _L = 10MΩ	1.0	V
Typical Output Short-Circuit Current @ I _{LED} = 5mA, @ T _A =+25°C (see figures 1 and 2)	1.0	μA
Maximum Turn-On Time @ I _{LED} = 5mA, C _{LOAD} = 200pF (see figure 4)	5	ms
Max. Turn-Off Time @ I _{LED} = 5mA, C _{LOAD} = 200pF (see figure 4)	0.25	ms
Off-State Clamping Resistance:		
minimum	100	Ω
maximum	3300	Ω

GENERAL CHARACTERISTICS	Limits	Units
Minimum Dielectric Strength, Input-Output	3750	V _{RMS}
Minimum Dielectric Strength, Output-to-Output	1200	V _{DC}
Minimum Insulation Resistance, Input-to-Output @ T _A =+25°C, 50%RH, 100V _{DC}	10 ¹²	Ω
Maximum Capacitance, Input-Output	5.0	pF
Maximum Pin Soldering Temperature (10 seconds maximum)	+260	°C
Ambient Temperature Range:		
Operating	-40 to +85	°C
Storage	-40 to +125	°C

International Rectifier does not recommend the use of this product in aerospace, avionics, military or life support applications. Users of this International Rectifier product in such applications assume all risks of such use and indemnify International Rectifier against all damages resulting from such use.

Connection Diagram

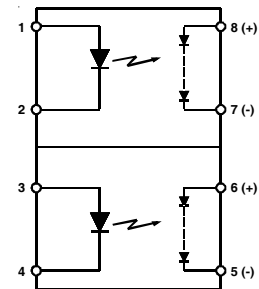

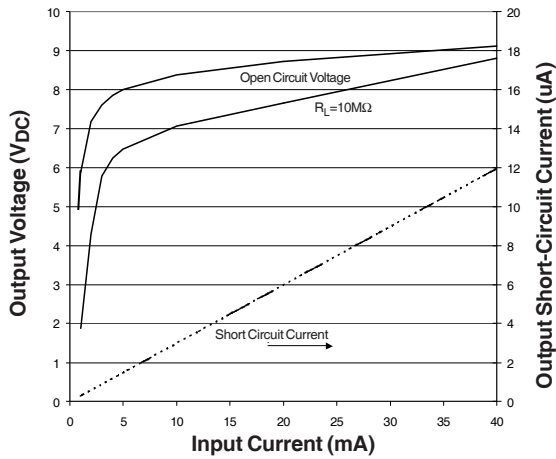

Figure 1. Typical Output Characteristics

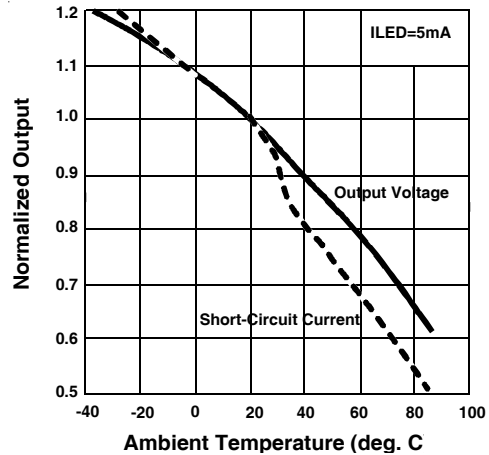

Figure 2. Typical Variation of Output

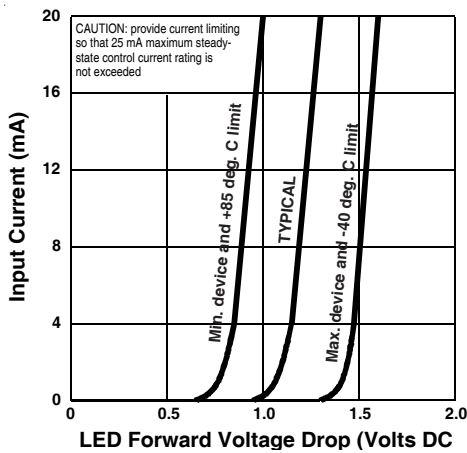

Figure 3. Input Characteristics (Current Controlled)

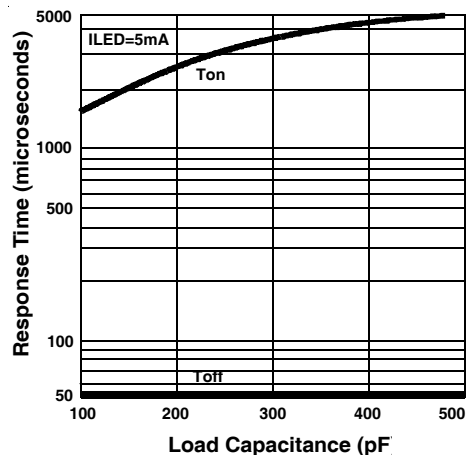
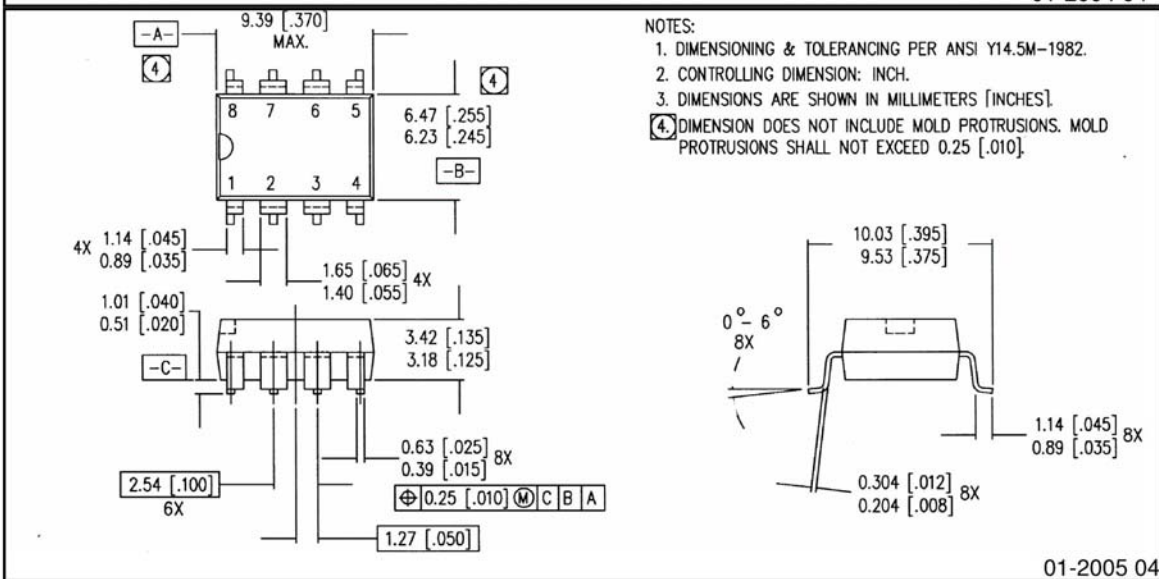
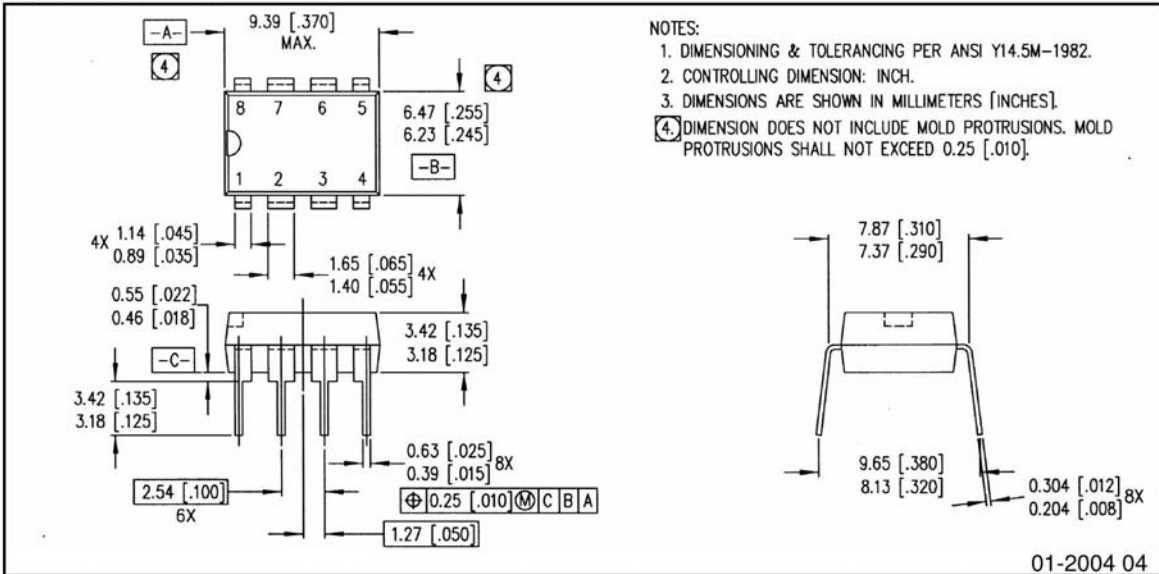

Figure 4. Typical Response Time

Case Outlines



Note: For the most current drawing please refer to IR website at: <http://www.irf.com/package/>



Qualification information[†]

Qualification level	Indusrid (per JEDEC JESD471 ^{††} guidelines)	
Moisture Sensitivity Level	PVI5013RPbF	N/A
	PVI5013RSPbF	MSL4 (per JEDEC J-STD-020E & JEDEC J-STD-033C ^{††})
	PVI5013RS-TPbF	
RoHS compliant	Yes	

† Qualification standards can be found at International Rectifier's web site <http://www.irf.com/product-info/reliability>

†† Applicable version of JEDEC standard at the time of product release.

Revision History

Date	Comment
4/24/2015	<ul style="list-style-type: none">• Added Qualification Information table on page 5.• Updated data sheet based on corporate template.

International
IOR Rectifier

IR WORLD HEADQUARTERS: 101 N. Sepulveda Blvd., El Segundo, California 90245, USA
To contact International Rectifier, please visit <http://www.irf.com/whoto-call/>