

Features

- Low Turn-on Voltage
- Fast Switching
- PN Junction Guard Ring for Transient and ESD Protection
- Ultra-Small Surface Mount Package
- **Lead Free/RoHS Compliant (Note 3)**
- **"Green" Device (Note 4 and 5)**

Mechanical Data

- Case: SOT-323
- Case Material: Molded Plastic, "Green" Molding Compound, Note 5. UL Flammability Classification Rating 94V-0
- Moisture Sensitivity: Level 1 per J-STD-020D
- Terminals: Solderable per MIL-STD-202, Method 208
- Lead Free Plating (Matte Tin Finish annealed over Alloy 42 leadframe).
- Polarity: See Diagrams Below
- Marking Information: See Page 2
- Ordering Information: See Page 2
- Weight: 0.006 grams (approximate)

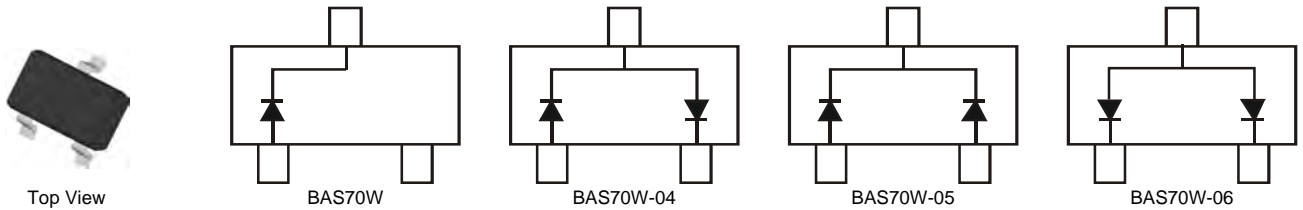

Maximum Ratings @T_A = 25°C unless otherwise specified

Characteristic	Symbol	Value	Unit
Peak Repetitive Reverse Voltage	V _{RRM}	70	V
Working Peak Reverse Voltage	V _{RWM}		
DC Blocking Voltage	V _R		
RMS Reverse Voltage	V _{R(RMS)}	49	V
Forward Continuous Current (Note 1)	I _F	70	mA
Non-Repetitive Peak Forward Surge Current @ t _p < 1.0s	I _{FSM}	100	mA

Thermal Characteristics

Characteristic	Symbol	Value	Unit
Power Dissipation (Note 1)	P _D	200	mW
Thermal Resistance Junction to Ambient Air (Note 1)	R _{θJA}	625	°C/W
Operating Temperature Range	T _J	-55 to +125	°C
Storage Temperature Range	T _{STG}	-65 to +150	°C

Electrical Characteristics @T_A = 25°C unless otherwise specified

Characteristic	Symbol	Min	Max	Unit	Test Condition
Reverse Breakdown Voltage (Note 2)	V _{(BR)R}	70	—	—	I _R = 10μA
Forward Voltage	V _F	—	410 1000	mV	t _p < 300μs, I _F = 1.0mA t _p < 300μs, I _F = 15mA
Reverse Current (Note 2)	I _R	—	100	nA	t _p < 300μs, V _R = 50V
Total Capacitance	C _T	—	2.0	pF	V _R = 0V, f = 1.0MHz
Reverse Recovery Time	t _{rr}	—	5.0	ns	I _F = I _R = 10mA to I _R = 1.0mA, I _{rr} = 0.1 x I _R , R _L = 100Ω

- Notes:
1. Device mounted on FR-4 PCB, 1 inch x 0.85 inch x 0.062 inch; pad layout as shown on Diodes Inc. suggested pad layout document AP02001, which can be found on our website at <http://www.diodes.com/datasheets/ap02001.pdf>.
 2. Short duration pulse test used to minimize self-heating effect.
 3. No purposefully added lead.
 4. Diodes Inc.'s "Green" policy can be found on our website at http://www.diodes.com/products/lead_free/index.php.
 5. Product manufactured with Date Code 0627 (week 27, 2006) and newer are built with Green Molding Compound. Product manufactured prior to Date Code 0627 are built with Non-Green Molding Compound and may contain Halogens or Sb2O3 Fire Retardants.

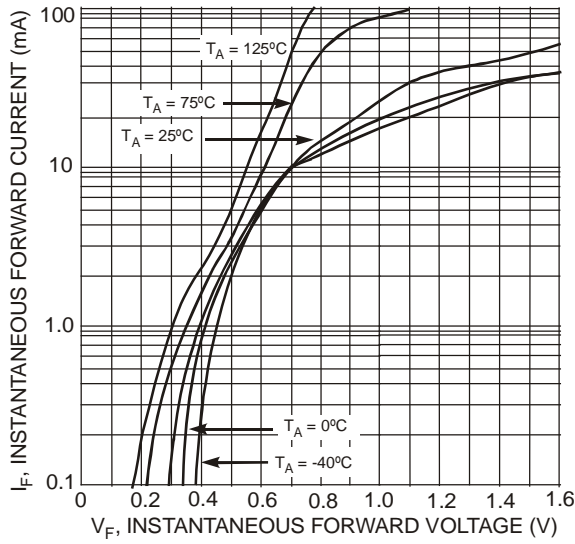

Fig. 1 Typical Forward Characteristics

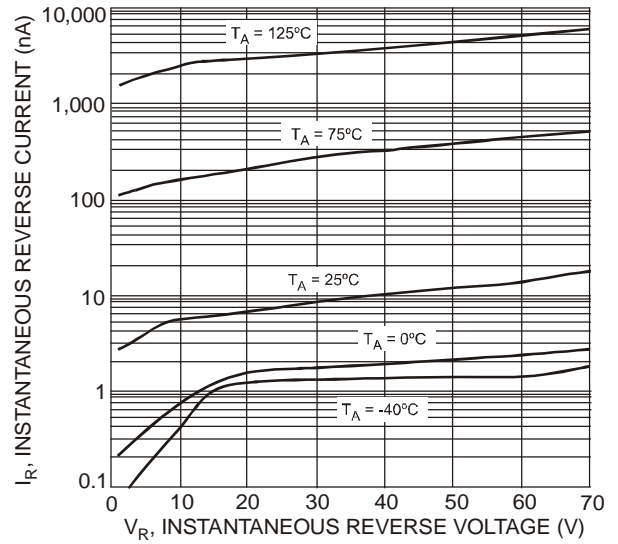

Fig. 2 Typical Reverse Characteristics

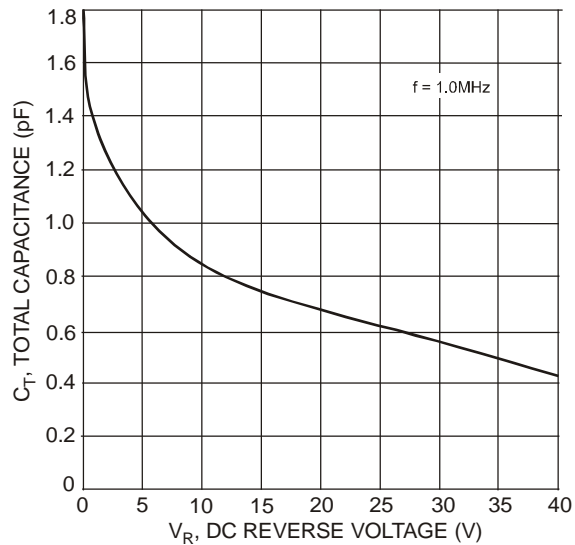

Fig. 3 Total Capacitance vs. Reverse Voltage

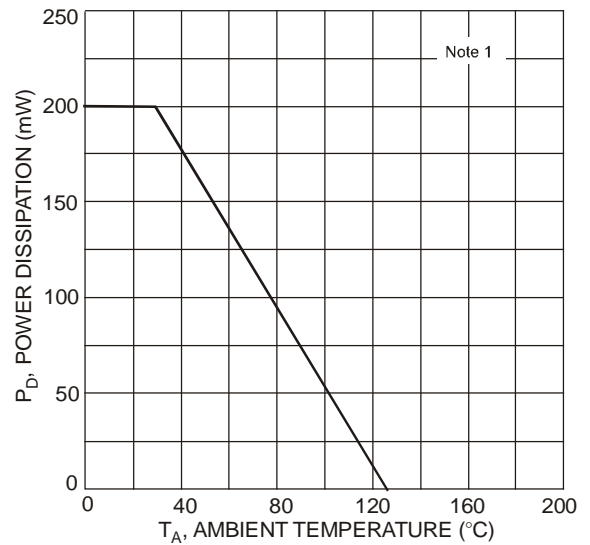

Fig. 4 Power Derating Curve, Total Package

Ordering Information (Notes 5 & 6)

Part Number	Case	Packaging
BAS70W-7-F	SOT-323	3000/Tape & Reel
BAS70W-04-7-F	SOT-323	3000/Tape & Reel
BAS70W-05-7-F	SOT-323	3000/Tape & Reel
BAS70W-06-7-F	SOT-323	3000/Tape & Reel

Notes: 6. For packaging details, go to our website at <http://www.diodes.com/datasheets/ap02007.pdf>.

Marking Information

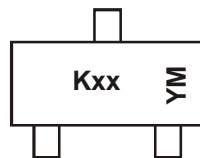

Kxx = Product Type Marking Code
 K73 = BAS70W
 K74 = BAS70W-04
 K75 = BAS70W-05
 K76 = BAS70W-06
 YM = Date Code Marking
 Y = Year (ex: N = 2002)
 M = Month (ex: 9 = September)

Date Code Key

Year	2002	2003	2004	2005	2006	2007	2008	2009	2010	2011	2012	2013	2014	2015
Code	N	P	R	S	T	U	V	W	X	Y	Z	A	B	C
Month	Jan	Feb	Mar	Apr	May	Jun	Jul	Aug	Sep	Oct	Nov	Dec		
Code	1	2	3	4	5	6	7	8	9	O	N	D		

Package Outline Dimensions

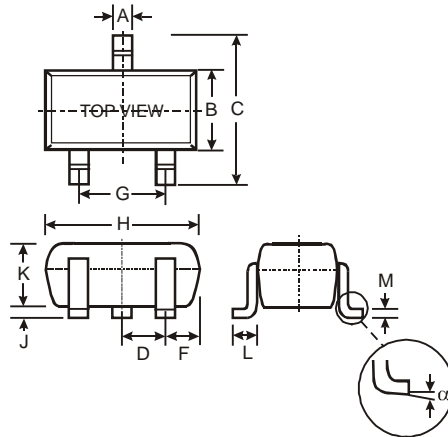

SOT-323			
Dim	Min	Max	Typ
A	0.25	0.40	0.30
B	1.15	1.35	1.30
C	2.00	2.20	2.10
D	-	-	0.65
F	0.30	0.40	0.425
G	1.20	1.40	1.30
H	1.80	2.20	2.15
J	0.0	0.10	0.05
K	0.90	1.00	1.00
L	0.25	0.40	0.30
M	0.10	0.18	0.11
α	0°	8°	-
All Dimensions in mm			

Suggested Pad Layout

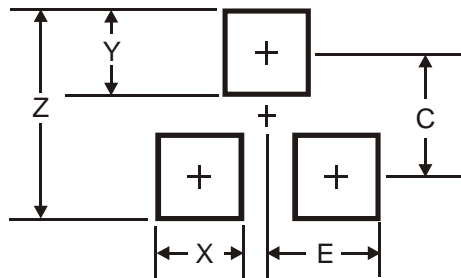

Dimensions	Value (in mm)
Z	2.8
X	0.7
Y	0.9
C	1.9
E	1.0

IMPORTANT NOTICE

Diodes Incorporated and its subsidiaries reserve the right to make modifications, enhancements, improvements, corrections or other changes without further notice to any product herein. Diodes Incorporated does not assume any liability arising out of the application or use of any product described herein; neither does it convey any license under its patent rights, nor the rights of others. The user of products in such applications shall assume all risks of such use and will agree to hold Diodes Incorporated and all the companies whose products are represented on our website, harmless against all damages.

LIFE SUPPORT

Diodes Incorporated products are not authorized for use as critical components in life support devices or systems without the expressed written approval of the President of Diodes Incorporated.