



IMPORTANT NOTICE

10 December 2015

1. Global joint venture starts operations as WeEn Semiconductors

Dear customer,

As from November 9th, 2015 NXP Semiconductors N.V. and Beijing JianGuang Asset Management Co. Ltd established Bipolar Power joint venture (JV), **WeEn Semiconductors**, which will be used in future Bipolar Power documents together with new contact details.

In this document where the previous NXP references remain, please use the new links as shown below.

WWW - For www.nxp.com use www.ween-semi.com

Email - For salesaddresses@nxp.com use salesaddresses@ween-semi.com

For the copyright notice at the bottom of each page (or elsewhere in the document, depending on the version) “© **NXP Semiconductors N.V. {year}. All rights reserved**” becomes “© **WeEn Semiconductors Co., Ltd. {year}. All rights reserved**”

If you have any questions related to this document, please contact our nearest sales office via e-mail or phone (details via salesaddresses@ween-semi.com).

Thank you for your cooperation and understanding,

WeEn Semiconductors



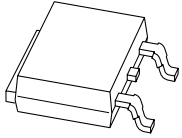

BT151S series L and R

Thyristors

Rev. 05 — 9 October 2006

Product data sheet

1. Product profile

1.1 General description

Passivated thyristors in a SOT428 plastic package.

1.2 Features

- High thermal cycling performance
- High bidirectional blocking voltage capability
- Surface-mounted package

1.3 Applications

- Motor control
- Ignition circuits
- Static switching
- Protection circuits

1.4 Quick reference data

- $V_{DRM} \leq 500$ V (BT151S-500L/R)
- $V_{RRM} \leq 500$ V (BT151S-500L/R)
- $V_{DRM} \leq 650$ V (BT151S-650L/R)
- $V_{RRM} \leq 650$ V (BT151S-650L/R)
- $V_{DRM} \leq 800$ V (BT151S-800R)
- $V_{RRM} \leq 800$ V (BT151S-800R)
- $I_{TSM} \leq 120$ A ($t = 10$ ms)
- $I_{T(RMS)} \leq 12$ A
- $I_{T(AV)} \leq 7.5$ A
- $I_{GT} \leq 5$ mA (BT151S series L)
- $I_{GT} \leq 15$ mA (BT151S series R)

2. Pinning information

Table 1. Pinning

Pin	Description	Simplified outline	Symbol
1	cathode (K)	<p>SOT428 (DPAK)</p>	<p>A \overline{K} G sym037</p>
2	anode (A)		
3	gate (G)		
mb	mounting base; connected to anode		

3. Ordering information

Table 2. Ordering information

Type number	Package		Version
	Name	Description	
BT151S-500L	DPAK	plastic single-ended surface-mounted package; 3 leads (one lead cropped)	SOT428
BT151S-500R			
BT151S-650L			
BT151S-650R			
BT151S-800R			
BT151S-800R			

4. Limiting values

Table 3. Limiting values

In accordance with the Absolute Maximum Rating System (IEC 60134).

Symbol	Parameter	Conditions	Min	Max	Unit
V_{DRM}	repetitive peak off-state voltage	BT151S-500L; BT151S-500R	[1] -	500	V
		BT151S-650L; BT151S-650R	[1] -	650	V
		BT151S-800R	-	800	V
V_{RRM}	repetitive peak reverse voltage	BT151S-500L; BT151S-500R	[1] -	500	V
		BT151S-650L; BT151S-650R	[1] -	650	V
		BT151S-800R	-	800	V
$I_{T(AV)}$	average on-state current	half sine wave; $T_{mb} \leq 103\text{ °C}$; see Figure 1	-	7.5	A
$I_{T(RMS)}$	RMS on-state current	all conduction angles; see Figure 4 and 5	-	12	A
I_{TSM}	non-repetitive peak on-state current	half sine wave; $T_j = 25\text{ °C}$ prior to surge; see Figure 2 and 3			
		$t = 10\text{ ms}$	-	120	A
		$t = 8.3\text{ ms}$	-	132	A
I^2t	I^2t for fusing	$t = 10\text{ ms}$	-	72	A ² s
di_T/dt	rate of rise of on-state current	$I_{TM} = 20\text{ A}$; $I_G = 50\text{ mA}$; $di_G/dt = 50\text{ mA}/\mu\text{s}$	-	50	A/ μs
I_{GM}	peak gate current		-	2	A
V_{RGM}	peak reverse gate voltage		-	5	V
P_{GM}	peak gate power		-	5	W
$P_{G(AV)}$	average gate power	over any 20 ms period	-	0.5	W
T_{stg}	storage temperature		-40	+150	°C
T_j	junction temperature		-	125	°C

- [1] Although not recommended, off-state voltages up to 800 V may be applied without damage, but the thyristor may switch to the on-state. The rate of rise of current should not exceed 15A/ μs .

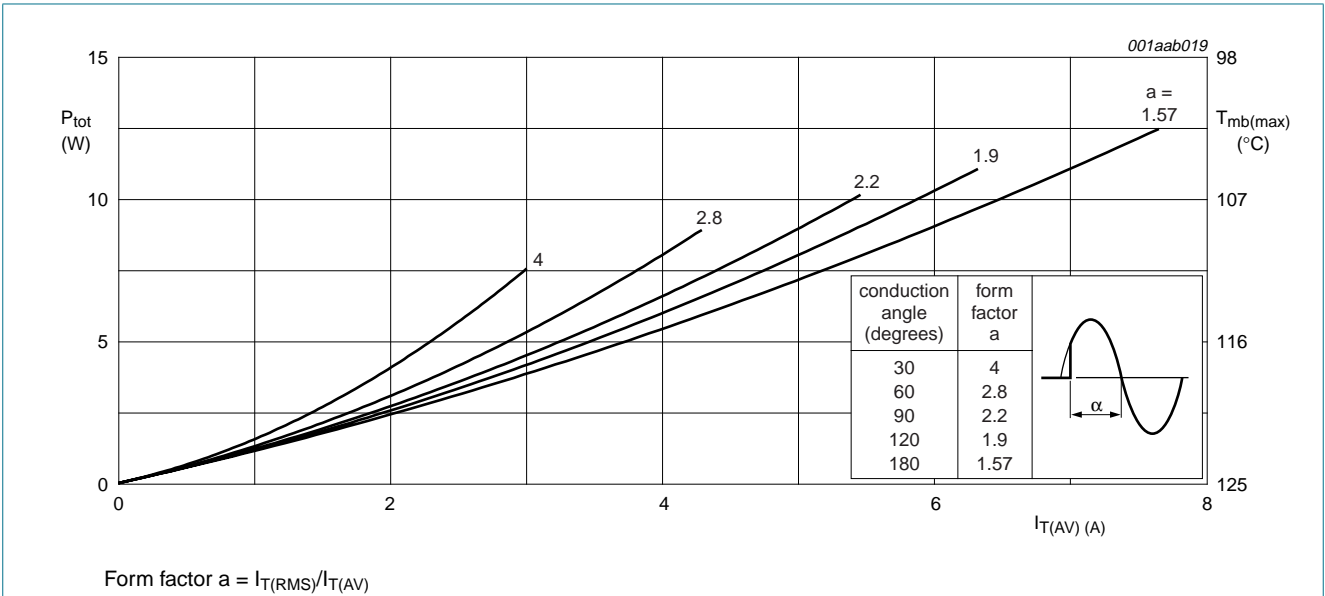

Fig 1. Total power dissipation as a function of average on-state current; maximum values

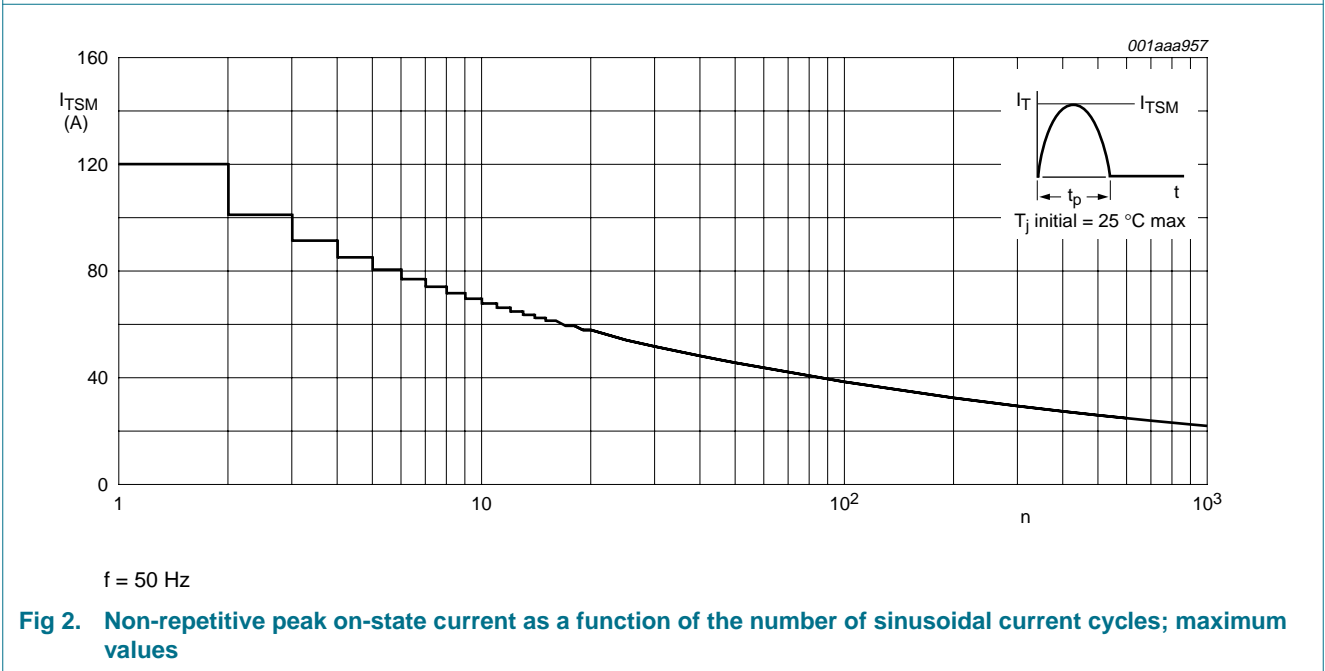
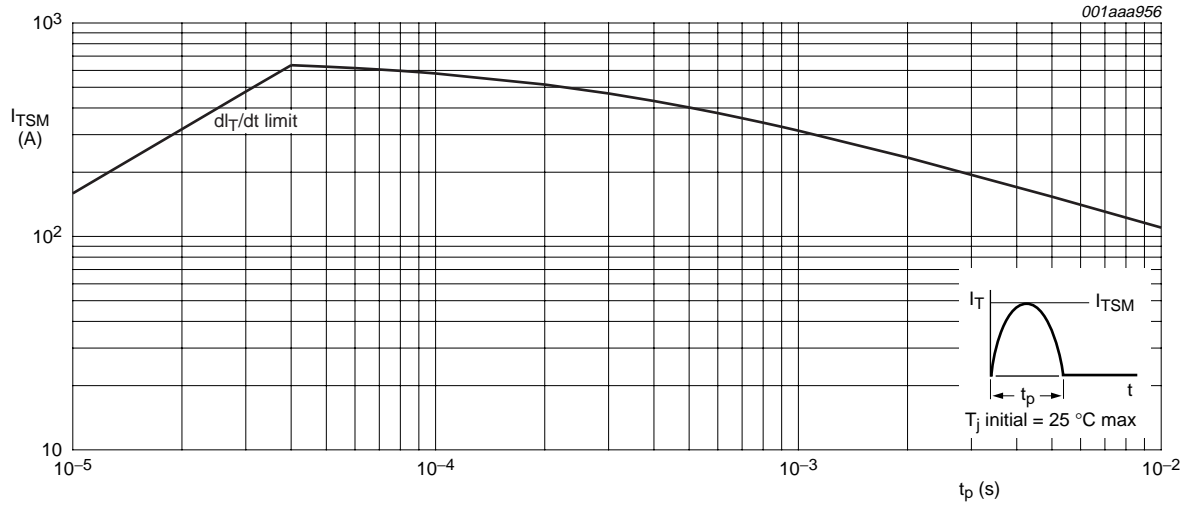
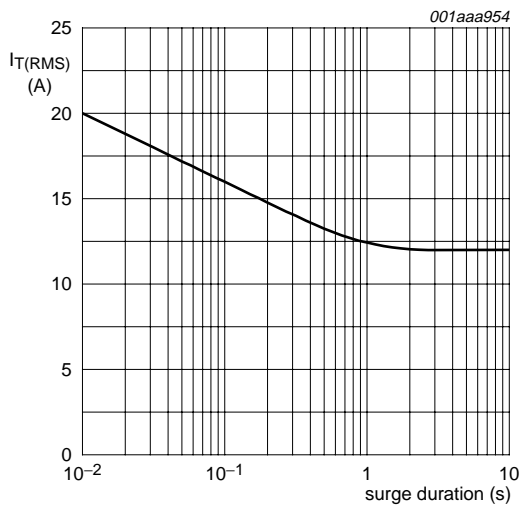

Fig 2. Non-repetitive peak on-state current as a function of the number of sinusoidal current cycles; maximum values



$t_p \leq 10 \text{ ms}$

Fig 3. Non-repetitive peak on-state current as a function of pulse width for sinusoidal currents; maximum values



$f = 50 \text{ Hz}; T_{mb} \leq 103 \text{ }^\circ\text{C}$

Fig 4. RMS on-state current as a function of surge duration; maximum values

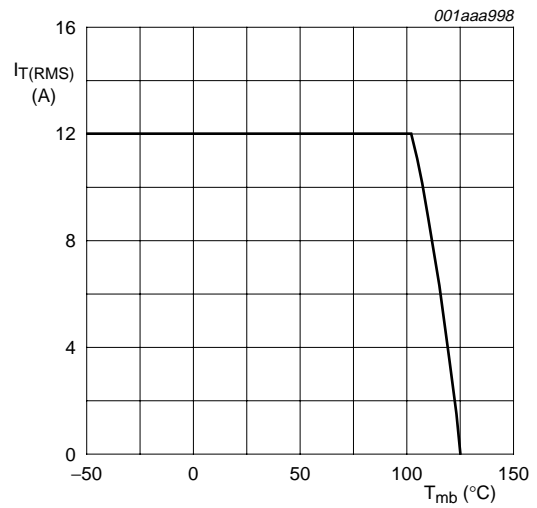
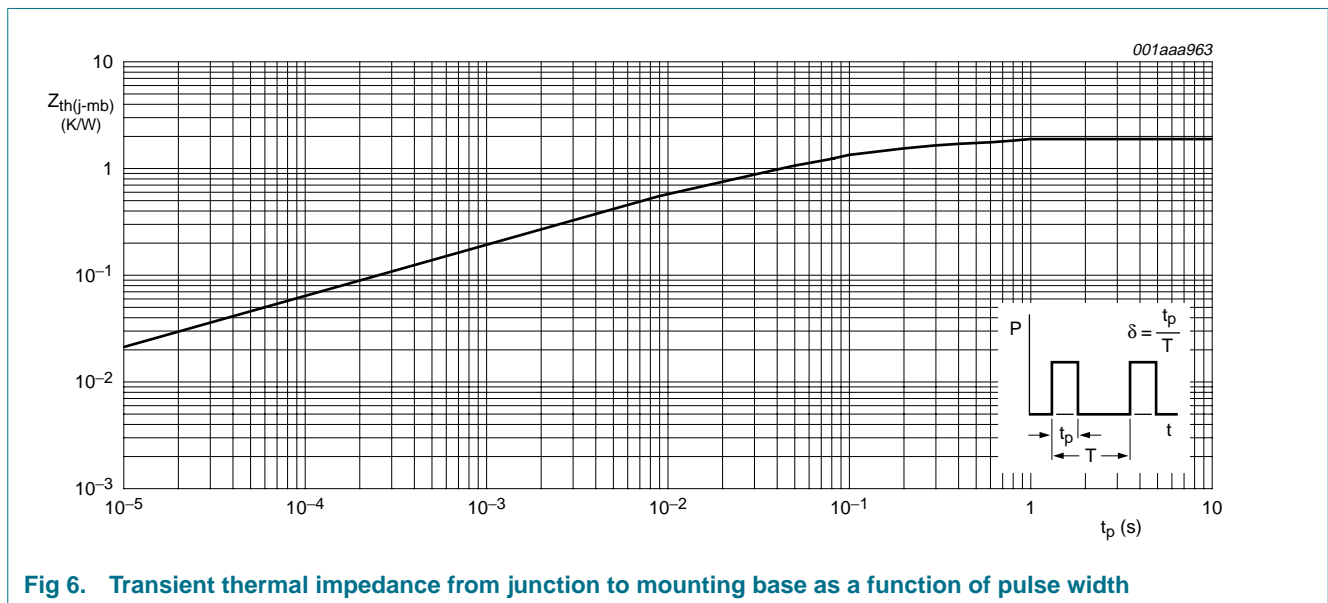

Fig 5. RMS on-state current as a function of mounting base temperature; maximum values

5. Thermal characteristics

Table 4. Thermal characteristics

Symbol	Parameter	Conditions	Min	Typ	Max	Unit
$R_{th(j-mb)}$	thermal resistance from junction to mounting base	see Figure 6	-	-	1.8	K/W
$R_{th(j-a)}$	thermal resistance from junction to ambient	mounted on an FR4 printed-circuit board; see Figure 14	-	75	-	K/W



6. Characteristics

Table 5. Characteristics
 $T_j = 25\text{ °C}$ unless otherwise stated.

Symbol	Parameter	Conditions	Min	Typ	Max	Unit
Static characteristics						
I_{GT}	gate trigger current	$V_D = 12\text{ V}$; $I_T = 100\text{ mA}$; see Figure 8				
		BT151S-500L	-	2	5	mA
		BT151S-500R	-	2	15	mA
		BT151S-650L	-	2	5	mA
		BT151S-650R	-	2	15	mA
		BT151S-800R	-	2	15	mA
I_L	latching current	$V_D = 12\text{ V}$; $I_{GT} = 100\text{ mA}$; see Figure 10	-	10	40	mA
I_H	holding current	$V_D = 12\text{ V}$; $I_{GT} = 100\text{ mA}$; see Figure 11	-	7	20	mA
V_T	on-state voltage	$I_T = 23\text{ A}$; see Figure 9	-	1.4	1.75	V
V_{GT}	gate trigger voltage	$I_T = 100\text{ mA}$; $V_D = 12\text{ V}$; see Figure 7	-	0.6	1.5	V
		$I_T = 100\text{ mA}$; $V_D = V_{DRM(max)}$; $T_j = 125\text{ °C}$	0.25	0.4	-	V
I_D	off-state current	$V_D = V_{DRM(max)}$; $T_j = 125\text{ °C}$	-	0.1	0.5	mA
I_R	reverse current	$V_R = V_{RRM(max)}$; $T_j = 125\text{ °C}$	-	0.1	0.5	mA
Dynamic characteristics						
dV_D/dt	rate of rise of off-state voltage	$V_{DM} = 0.67 \times V_{DRM(max)}$; $T_j = 125\text{ °C}$; exponential waveform; see Figure 12				
		$R_{GK} = 100\ \Omega$	200	1000	-	V/ μ s
		gate open circuit	50	130	-	V/ μ s
t_{gt}	gate-controlled turn-on time	$I_{TM} = 40\text{ A}$; $V_D = V_{DRM(max)}$; $I_G = 100\text{ mA}$; $dl_G/dt = 5\text{ A}/\mu\text{s}$	-	2	-	μ s
t_q	commutated turn-off time	$V_{DM} = 0.67 \times V_{DRM(max)}$; $T_j = 125\text{ °C}$; $I_{TM} = 20\text{ A}$; $V_R = 25\text{ V}$; $(dl_T/dt)_M = 30\text{ A}/\mu\text{s}$; $dV_D/dt = 50\text{ V}/\mu\text{s}$; $R_{GK} = 100\ \Omega$	-	70	-	μ s

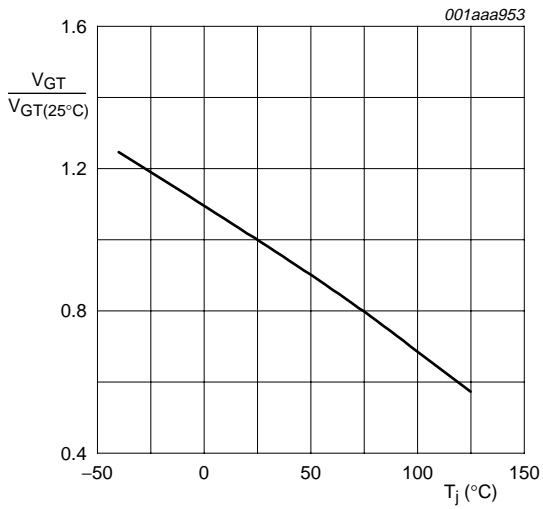

Fig 7. Normalized gate trigger voltage as a function of junction temperature

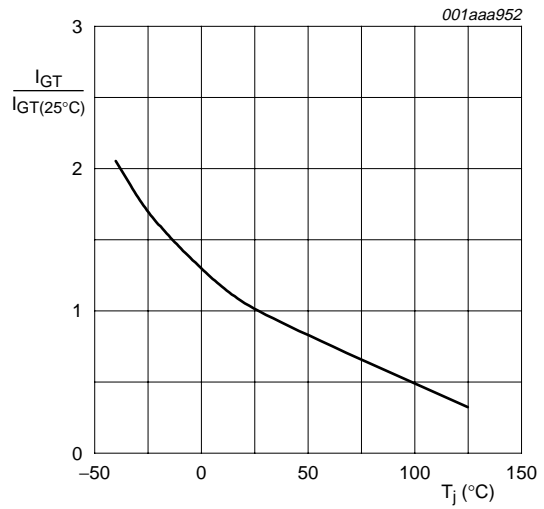
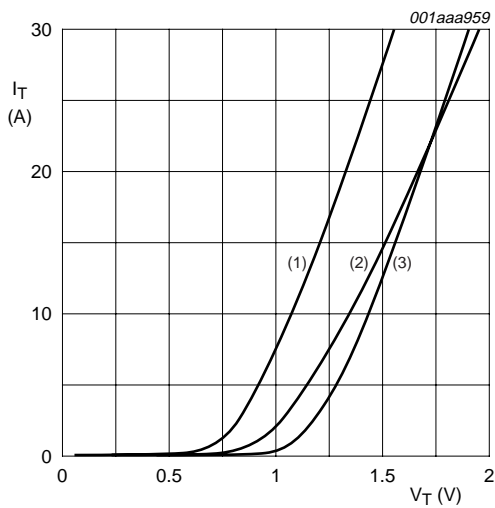

Fig 8. Normalized gate trigger current as a function of junction temperature



$V_o = 1.06\text{ V}$
 $R_s = 0.0304\ \Omega$

- (1) $T_j = 125\text{ }^\circ\text{C}$; typical values
- (2) $T_j = 125\text{ }^\circ\text{C}$; maximum values
- (3) $T_j = 25\text{ }^\circ\text{C}$; maximum values

Fig 9. On-state current as a function of on-state voltage

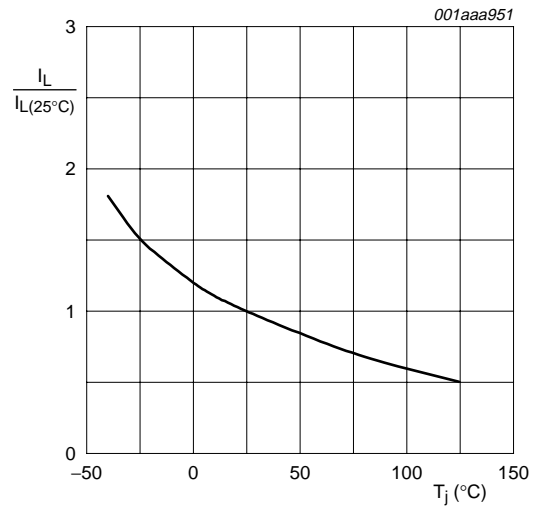

Fig 10. Normalized latching current as a function of junction temperature

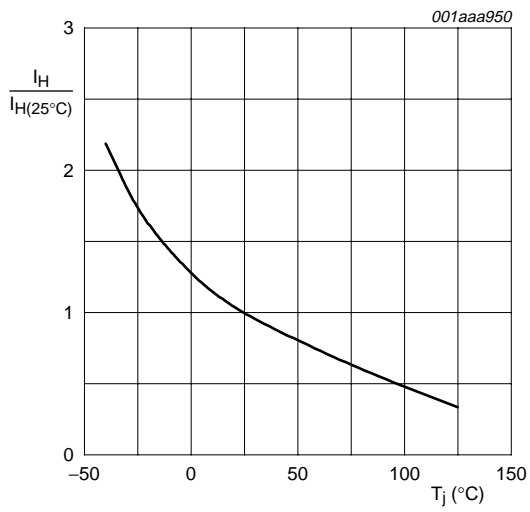
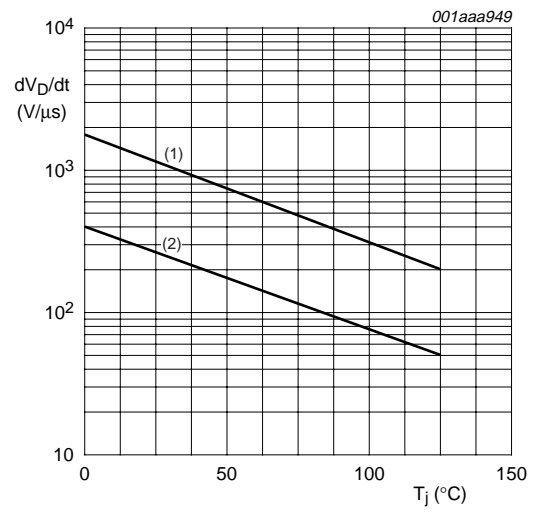

Fig 11. Normalized holding current as a function of junction temperature



- (1) $R_{GK} = 100 \Omega$
- (2) Gate open circuit

Fig 12. Critical rate of rise of off-state voltage as a function of junction temperature; minimum values

7. Package outline

Plastic single-ended surface-mounted package (DPAK); 3 leads (one lead cropped)

SOT428

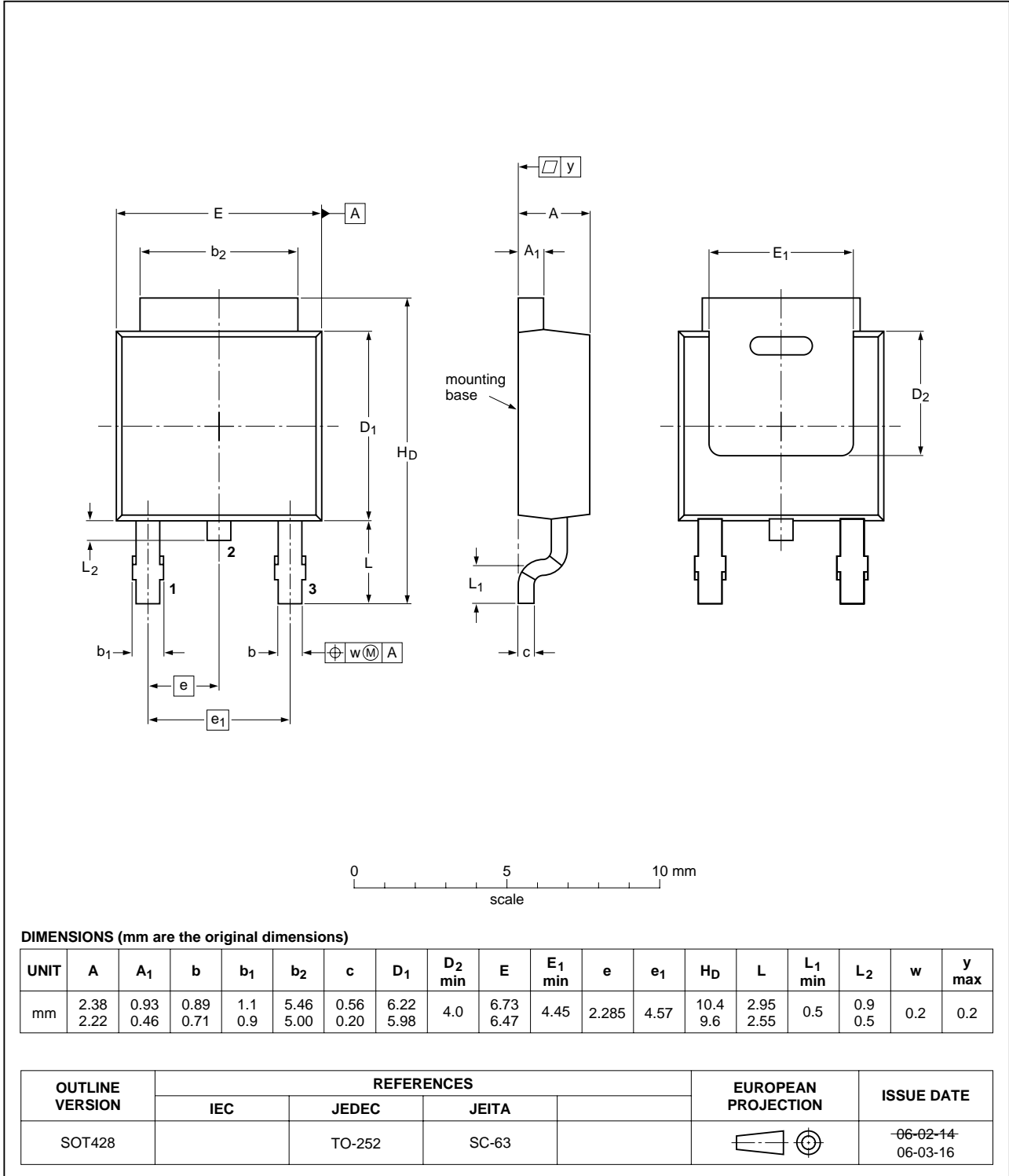
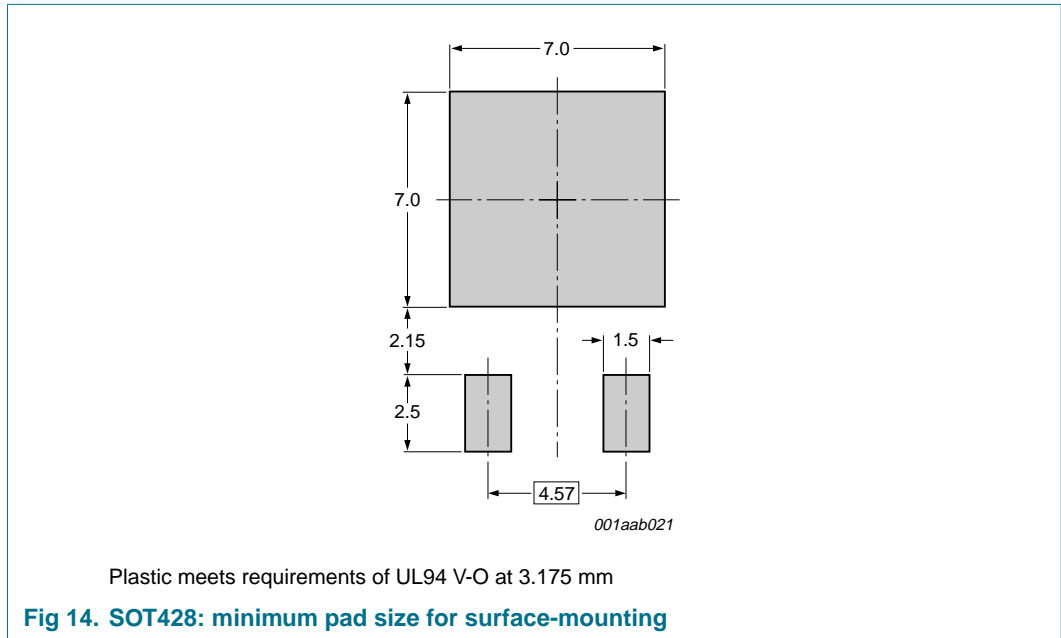

Fig 13. Package outline SOT428 (DPAK)

8. Mounting



9. Revision history

Table 6. Revision history

Document ID	Release date	Data sheet status	Change notice	Supersedes
BT151S_SER_L_R_5	20061009	Product data sheet	-	BT151S_SERIES_4
Modifications:		<ul style="list-style-type: none">• The format of this data sheet has been redesigned to comply with the new identity guidelines of NXP Semiconductors.• Legal texts have been adapted to the new company name where appropriate.• Added type numbers BT151S-500L and BT151S-650L		
BT151S_SERIES_4 (9397 750 13161)	20040609	Product specification	-	BT151S_SERIES_3
BT151S_SERIES_3	20020101	Product specification	-	BT151S_SERIES_2
BT151S_SERIES_2	19990601	Product specification	-	BT151S_SERIES_1
BT151S_SERIES_1	19970901	Product specification	-	-

10. Legal information

10.1 Data sheet status

Document status ^{[1][2]}	Product status ^[3]	Definition
Objective [short] data sheet	Development	This document contains data from the objective specification for product development.
Preliminary [short] data sheet	Qualification	This document contains data from the preliminary specification.
Product [short] data sheet	Production	This document contains the product specification.

[1] Please consult the most recently issued document before initiating or completing a design.

[2] The term 'short data sheet' is explained in section "Definitions".

[3] The product status of device(s) described in this document may have changed since this document was published and may differ in case of multiple devices. The latest product status information is available on the Internet at URL <http://www.nxp.com>.

10.2 Definitions

Draft — The document is a draft version only. The content is still under internal review and subject to formal approval, which may result in modifications or additions. NXP Semiconductors does not give any representations or warranties as to the accuracy or completeness of information included herein and shall have no liability for the consequences of use of such information.

Short data sheet — A short data sheet is an extract from a full data sheet with the same product type number(s) and title. A short data sheet is intended for quick reference only and should not be relied upon to contain detailed and full information. For detailed and full information see the relevant full data sheet, which is available on request via the local NXP Semiconductors sales office. In case of any inconsistency or conflict with the short data sheet, the full data sheet shall prevail.

10.3 Disclaimers

General — Information in this document is believed to be accurate and reliable. However, NXP Semiconductors does not give any representations or warranties, expressed or implied, as to the accuracy or completeness of such information and shall have no liability for the consequences of use of such information.

Right to make changes — NXP Semiconductors reserves the right to make changes to information published in this document, including without limitation specifications and product descriptions, at any time and without notice. This document supersedes and replaces all information supplied prior to the publication hereof.

Suitability for use — NXP Semiconductors products are not designed, authorized or warranted to be suitable for use in medical, military, aircraft, space or life support equipment, nor in applications where failure or

malfunction of a NXP Semiconductors product can reasonably be expected to result in personal injury, death or severe property or environmental damage. NXP Semiconductors accepts no liability for inclusion and/or use of NXP Semiconductors products in such equipment or applications and therefore such inclusion and/or use is at the customer's own risk.

Applications — Applications that are described herein for any of these products are for illustrative purposes only. NXP Semiconductors makes no representation or warranty that such applications will be suitable for the specified use without further testing or modification.

Limiting values — Stress above one or more limiting values (as defined in the Absolute Maximum Ratings System of IEC 60134) may cause permanent damage to the device. Limiting values are stress ratings only and operation of the device at these or any other conditions above those given in the Characteristics sections of this document is not implied. Exposure to limiting values for extended periods may affect device reliability.

Terms and conditions of sale — NXP Semiconductors products are sold subject to the general terms and conditions of commercial sale, as published at <http://www.nxp.com/profile/terms>, including those pertaining to warranty, intellectual property rights infringement and limitation of liability, unless explicitly otherwise agreed to in writing by NXP Semiconductors. In case of any inconsistency or conflict between information in this document and such terms and conditions, the latter will prevail.

No offer to sell or license — Nothing in this document may be interpreted or construed as an offer to sell products that is open for acceptance or the grant, conveyance or implication of any license under any copyrights, patents or other industrial or intellectual property rights.

10.4 Trademarks

Notice: All referenced brands, product names, service names and trademarks are the property of their respective owners.

11. Contact information

For additional information, please visit: <http://www.nxp.com>

For sales office addresses, send an email to: salesaddresses@nxp.com

12. Contents

1 **Product profile** 1

1.1 General description. 1

1.2 Features 1

1.3 Applications 1

1.4 Quick reference data. 1

2 **Pinning information**. 1

3 **Ordering information**. 2

4 **Limiting values**. 2

5 **Thermal characteristics**. 5

6 **Characteristics**. 6

7 **Package outline** 9

8 **Mounting**. 10

9 **Revision history**. 11

10 **Legal information**. 12

10.1 Data sheet status 12

10.2 Definitions 12

10.3 Disclaimers 12

10.4 Trademarks 12

11 **Contact information**. 12

12 **Contents** 13



Please be aware that important notices concerning this document and the product(s) described herein, have been included in section 'Legal information'.

© NXP B.V. 2006. All rights reserved.

For more information, please visit: <http://www.nxp.com>
 For sales office addresses, please send an email to: salesaddresses@nxp.com

Date of release: 9 October 2006
 Document identifier: BT151S_SER_L_R_5