

Silicon N-Channel MOSFET Tetrode

- For low noise, high gain controlled input stage up to 1 GHz
- Operating voltage 9 V
- Integrated biasing network
- Pb-free (RoHS compliant) package¹⁾
- Qualified according AEC Q101

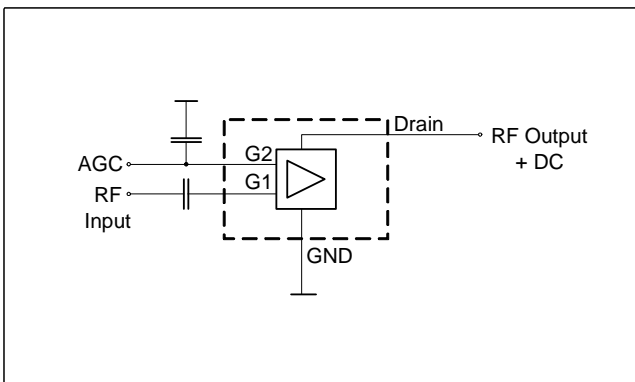
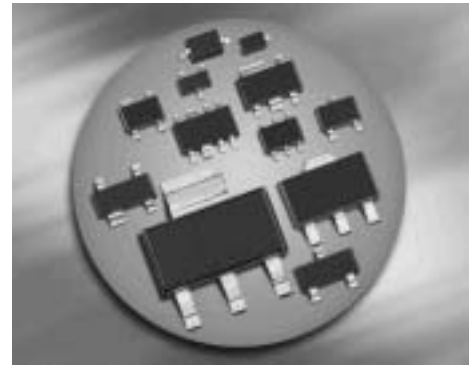

ESD (Electrostatic discharge) sensitive device, observe handling precaution!

Type	Package	Pin Configuration						Marking
BF1009S	SOT143	1=S	2=D	3=G2	4=G1	-	-	JLs
BF1009SR	SOT143R	1=D	2=S	3=G1	4=G2	-	-	JLs

Maximum Ratings

Parameter	Symbol	Value	Unit
Drain-source voltage	V_{DS}	12	V
Continuous drain current	I_D	25	mA
Gate 1/ gate 2-source current	$\pm I_{G1/2SM}$	10	
Gate 1 (external biasing)	$+V_{G1SE}$	3	V
Total power dissipation $T_S \leq 76 \text{ }^\circ\text{C}$, BF1009S, BF1009SR	P_{tot}	200	mW
Storage temperature	T_{stg}	-55 ... 150	$^\circ\text{C}$
Channel temperature	T_{ch}	150	

¹Pb-containing package may be available upon special request

Note:

It is not recommended to apply external DC-voltage on Gate 1 in active mode.

Thermal Resistance

Parameter	Symbol	Value	Unit
Channel - soldering point ¹⁾ BF1009S, BF1009SR	R_{thchs}	≤ 370	K/W

Electrical Characteristics at $T_A = 25^\circ\text{C}$, unless otherwise specified

Parameter	Symbol	Values			Unit
		min.	typ.	max.	

DC Characteristics

Drain-source breakdown voltage $I_D = 500 \mu\text{A}$, $V_{G1S} = 0$, $V_{G2S} = 0$	$V_{(BR)DS}$	12	-	-	V
Gate1-source breakdown voltage $+I_{G1S} = 10 \text{ mA}$, $V_{G2S} = 0$, $V_{DS} = 0$	$+V_{(BR)G1SS}$	9	-	12	
Gate2 source breakdown voltage $\pm I_{G2S} = 10 \text{ mA}$, $V_{G1S} = 0$, $V_{DS} = 0$	$\pm V_{(BR)G2SS}$	9	-	12	
Gate1-source leakage current $V_{G1S} = 6 \text{ V}$, $V_{G2S} = 0$	$+I_{G1SS}$	-	-	60	μA
Gate 2 source leakage current $\pm V_{G2S} = 8 \text{ V}$, $V_{G1S} = 0$, $V_{DS} = 0$	$\pm I_{G2SS}$	-	-	50	nA
Drain current $V_{DS} = 9 \text{ V}$, $V_{G1S} = 0$, $V_{G2S} = 6 \text{ V}$	I_{DSS}	-	-	500	μA
Operating current (selfbiased) $V_{DS} = 9 \text{ V}$, $V_{G2S} = 6 \text{ V}$	I_{DSO}	10	13	16	mA
Gate2-source pinch-off voltage $V_{DS} = 9 \text{ V}$, $I_D = 500 \mu\text{A}$	$V_{G2S(p)}$	-	0.9	-	V

¹⁾For calculation of R_{thJA} please refer to Application Note Thermal Resistance

Electrical Characteristics at $T_A = 25^\circ\text{C}$, unless otherwise specified

Parameter	Symbol	Values			Unit
		min.	typ.	max.	
AC Characteristics (verified by random sampling)					
Forward transconductance $V_{DS} = 9\text{ V}$, $V_{G2S} = 6\text{ V}$	g_{fs}	26	30	-	mS
Gate1 input capacitance $V_{DS} = 9\text{ V}$, $V_{G2S} = 6\text{ V}$, $f = 10\text{ MHz}$	C_{g1ss}	-	2.1	2.7	pF
Output capacitance $V_{DS} = 9\text{ V}$, $V_{G2S} = 6\text{ V}$, $f = 10\text{ MHz}$	C_{dss}	-	0.9	-	
Power gain (self biased) $V_{DS} = 9\text{ V}$, $V_{G2S} = 6\text{ V}$, $f = 800\text{ MHz}$	G_p	18	22	-	dB
Noise figure $V_{DS} = 9\text{ V}$, $V_{G2S} = 6\text{ V}$, $f = 800\text{ MHz}$	F	-	1.4	2.1	dB
Gain control range $V_{DS} = 9\text{ V}$, $V_{G2S} = 6 \dots 0\text{ V}$, $f = 800\text{ MHz}$	ΔG_p	40	50	-	

Total power dissipation $P_{tot} = f(T_S)$

BF1009S, BF1009SR

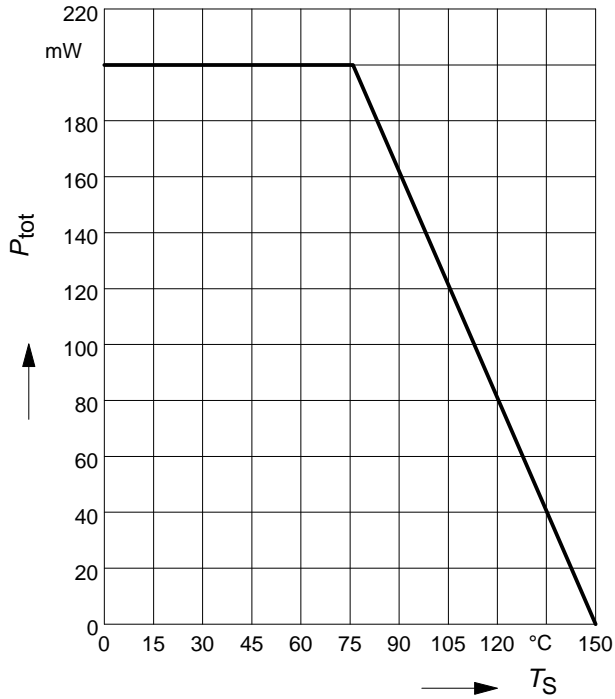
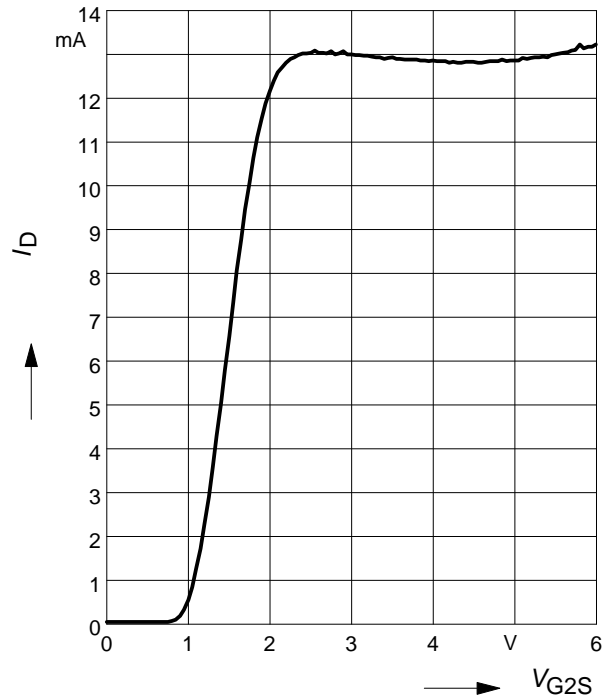
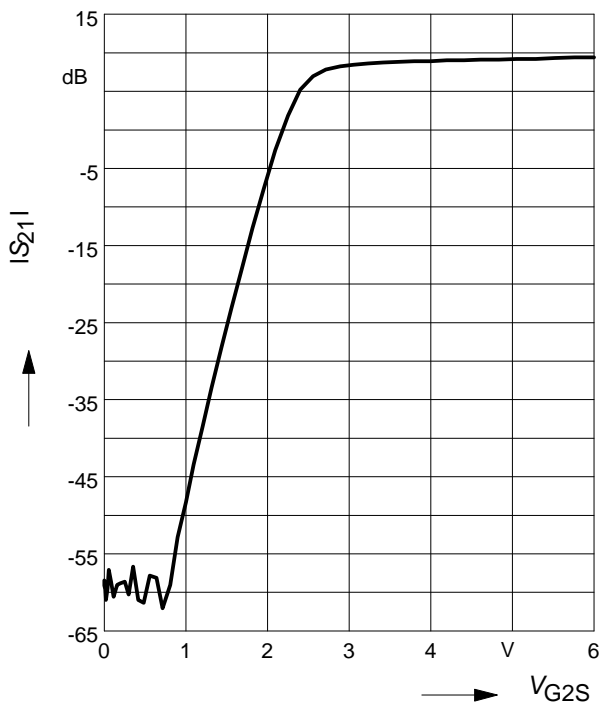
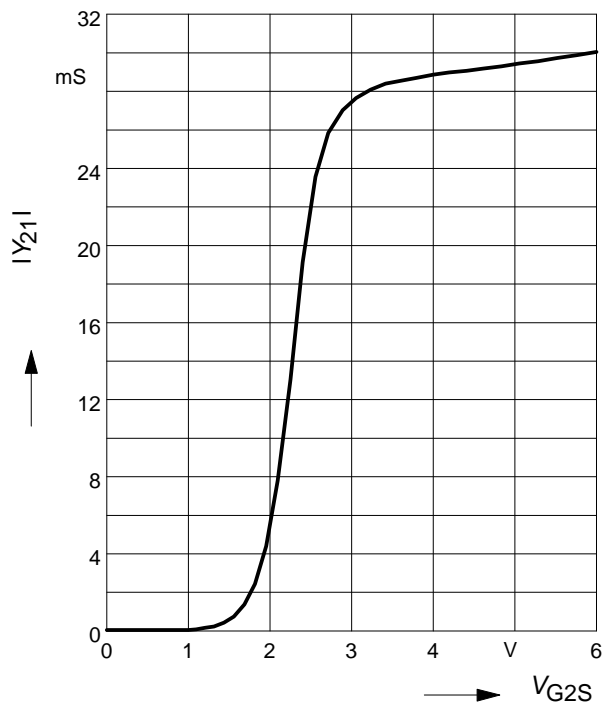
Drain current $I_D = f(V_{G2S})$
 $V_{DS} = 9\text{ V}$

Insertion power gain
 $|S_{21}|^2 = f(V_{G2S}), f = 200\text{ MHz}$

Forward transfer admittance
 $|Y_{21}| = f(V_{G2S}), f = 200\text{ MHz}$

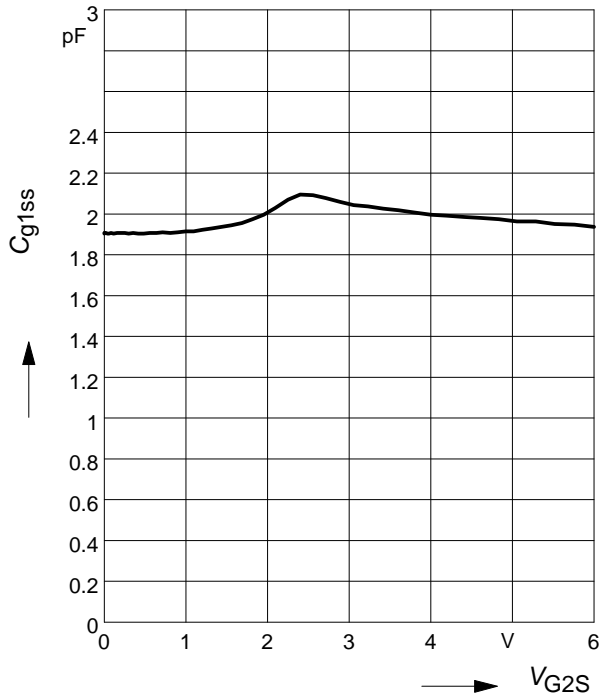
Gate 1 input capacitance $C_{g1ss} = f(V_{G2S})$

$f = 200 \text{ MHz}$



Output capacitance $C_{dss} = f(V_{G2S})$

$f = 200 \text{ MHz}$

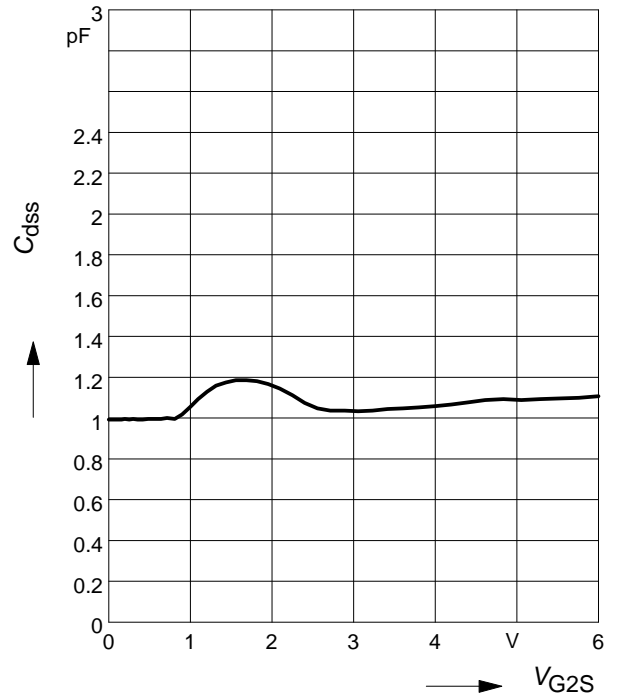

Package Outline

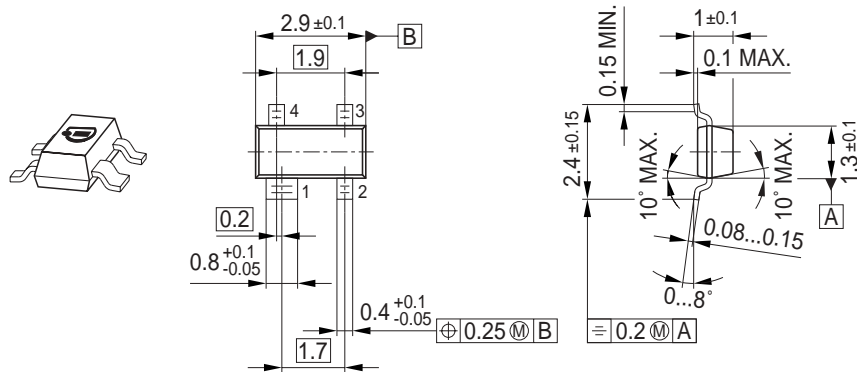

Foot Print

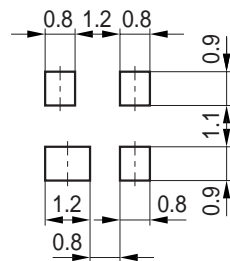

Marking Layout (Example)

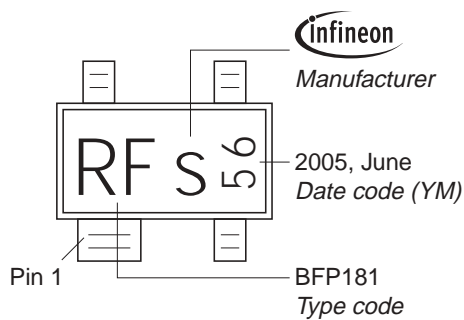

Standard Packing

Reel $\varnothing 180 \text{ mm} = 3.000 \text{ Pieces/Reel}$
 Reel $\varnothing 330 \text{ mm} = 10.000 \text{ Pieces/Reel}$



Package Outline

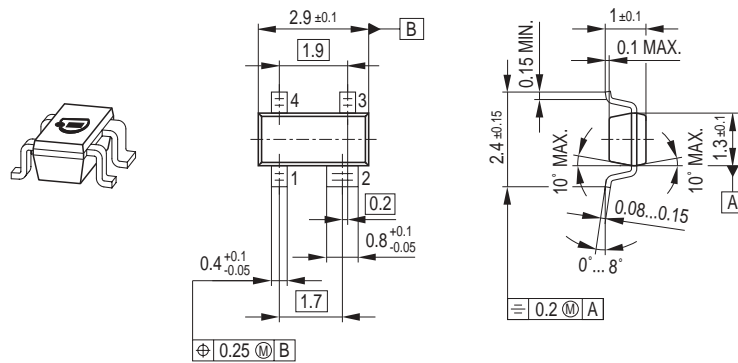

Foot Print

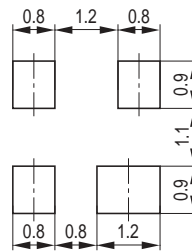

Marking Layout (Example)

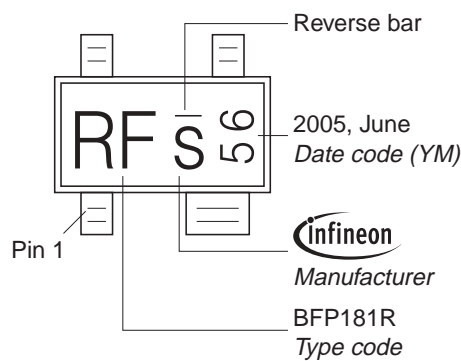

Standard Packing

Reel ø180 mm = 3.000 Pieces/Reel
 Reel ø330 mm = 10.000 Pieces/Reel

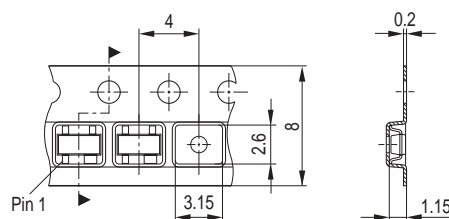

Edition 2006-02-01

Published by

Infineon Technologies AG

81726 München, Germany

© Infineon Technologies AG 2007.

All Rights Reserved.

Attention please!

The information given in this dokument shall in no event be regarded as a guarantee of conditions or characteristics ("Beschaffenheitsgarantie"). With respect to any examples or hints given herein, any typical values stated herein and/or any information regarding the application of the device, Infineon Technologies hereby disclaims any and all warranties and liabilities of any kind, including without limitation warranties of non-infringement of intellectual property rights of any third party.

Information

For further information on technology, delivery terms and conditions and prices please contact your nearest Infineon Technologies Office (www.infineon.com).

Warnings

Due to technical requirements components may contain dangerous substances. For information on the types in question please contact your nearest Infineon Technologies Office.

Infineon Technologies Components may only be used in life-support devices or systems with the express written approval of Infineon Technologies, if a failure of such components can reasonably be expected to cause the failure of that life-support device or system, or to affect the safety or effectiveness of that device or system.

Life support devices or systems are intended to be implanted in the human body, or to support and/or maintain and sustain and/or protect human life. If they fail, it is reasonable to assume that the health of the user or other persons may be endangered.