

Description

The DIODES™ ZXMS81045SPQ is a single-channel, high-side, power switch in a SO-8EP (Type E) exposed heatsink package incorporating protective and diagnostic functions.

The device comprises a monolithic N-channel vertical power MOSFET with integrated temperature and current sensors with a charge-pumped gate supply and has a low quiescent current in OFF state.

The device is enabled by active high 3.3V and 5V logic level drive to the inputs. The device includes a diagnostic current-sense output proportional to load current and a defined diagnostic fault signal in case of overload operation, overtemperature, short-circuit or open load conditions.

Features

Protection Functions

- Reverse battery protection using external components
- Voltage dependent current limiting
- Overtemperature protection with auto-restart
- Overvoltage protection including load dump
- Stable undervoltage protection
- ESD protection
- Loss of ground protection with external components
- Enhanced short circuit protection

Diagnostic Functions

- Proportional load current-sense output
 - Linear voltage drop regulation to maintain sense accuracy even at very low load currents
 - Enabled by logic input
 - Defined temperature and current dependency
- Open-load detection
 - Using load current-sense in ON state
 - Using output voltage detection in OFF state
- Defined fault signal in case of overload operation, overtemperature, or short-circuit

Miscellaneous

- **Lead-Free Finish; RoHS Compliant (Notes 1 & 2)**
- **Halogen and Antimony Free. "Green" Device (Note 3)**
- **The ZXMS81045SPQ is suitable for automotive applications requiring specific change control; this part is AEC-Q100 qualified, PPAP capable, and manufactured in IATF16949 certified facilities.**

<https://www.diodes.com/quality/product-definitions/>

Notes:

1. EU Directive 2002/95/EC (RoHS), 2011/65/EU (RoHS 2) & 2015/863/EU (RoHS 3) compliant. All applicable RoHS exemptions applied.
2. See <https://www.diodes.com/quality/lead-free/> for more information about Diodes Incorporated's definitions of Halogen- and Antimony-free, "Green" and Lead-free.
3. Halogen- and Antimony-free "Green" products are defined as those which contain <900ppm bromine, <900ppm chlorine (<1500ppm total Br + Cl) and <1000ppm antimony compounds.
4. For packaging details, go to our website at <https://www.diodes.com/design/support/packaging/diodes-packaging/>.

IntelliFET is a trademark of Diodes Incorporated in the United States and other countries.

ZXMS81045SPQ

Document number: DS44103 Rev. 3 - 2

1 of 34

www.diodes.com

May 2022

© Diodes Incorporated

Pin Assignment

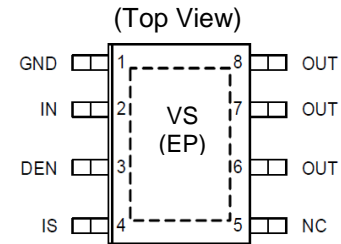

SO-8EP

Applications

- High-side switching with diagnostic feedback for:
 - 12V grounded loads
 - Resistive, inductive, and capacitive loads
- Suitable for high inrush current loads
 - Incandescent lamps (P27W/P21W), motors, etc
- Compact low-power replacement for:
 - Relays, fuses, and discrete circuits

Summary Specifications

Operating voltage	V_S	5 - 28V
Maximum supply voltage	$V_{S(LD)}$	41V
Maximum ON resistance, $T_j = 150^\circ\text{C}$	$R_{DS(ON)}$	90m Ω
Nominal load current	$I_{L(NOM)}$	4A
Typical current sense ratio	K_{ILIS}	1200
Minimum current limitation	$I_{L5(SC)}$	25A
Maximum standby current, $T_j = 25^\circ\text{C}$	$I_{S(OFF)}$	0.5 μA

Typical Application Circuit

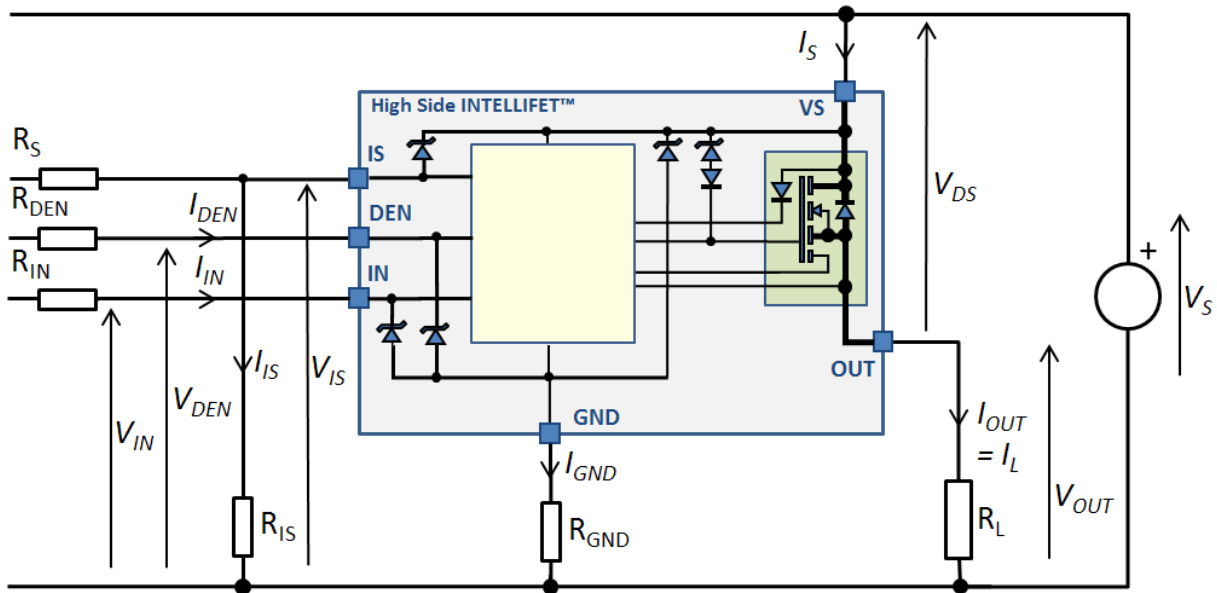

Figure 1. Typical Application Configuration

R_{GND} , R_{IN} , R_{DEN} and R_S are optional. They may be replaced by shorts depending on the application. Non-zero resistors may be used to:

- reduce peak currents during supply voltage transients that exceed the $\pm V_S$ internal clamp voltages
 - typically transients exceeding 41 V or may activate the internal clamps
- protect the customer's application from high currents during transients exceeding 41V
- keep within rated current during reverse battery, recommended is $R_S = R_{DEN} = R_{IN} = 4.7k\Omega$, $R_{GND} = 150\Omega$
- ensure that the device is off when there is loss of ground connection to the device or module

Pin Description

Number	Name	Function and description
1	GND	Ground or negative supply
2	IN	Input, activates the output
3	DEN	Diagnostic enable, allows common connection of the IS pin with multiple devices
4	IS	Diagnostic output, provides an analogue sense current proportional to the load current under normal operation, or a defined current under overload or shutdown conditions
5	NC	Not connected
6, 7, 8	OUT	Output to the load, must be connected together
EP	VS	Voltage supply or battery positive

Table 1. Pin description

Functional Block Diagram

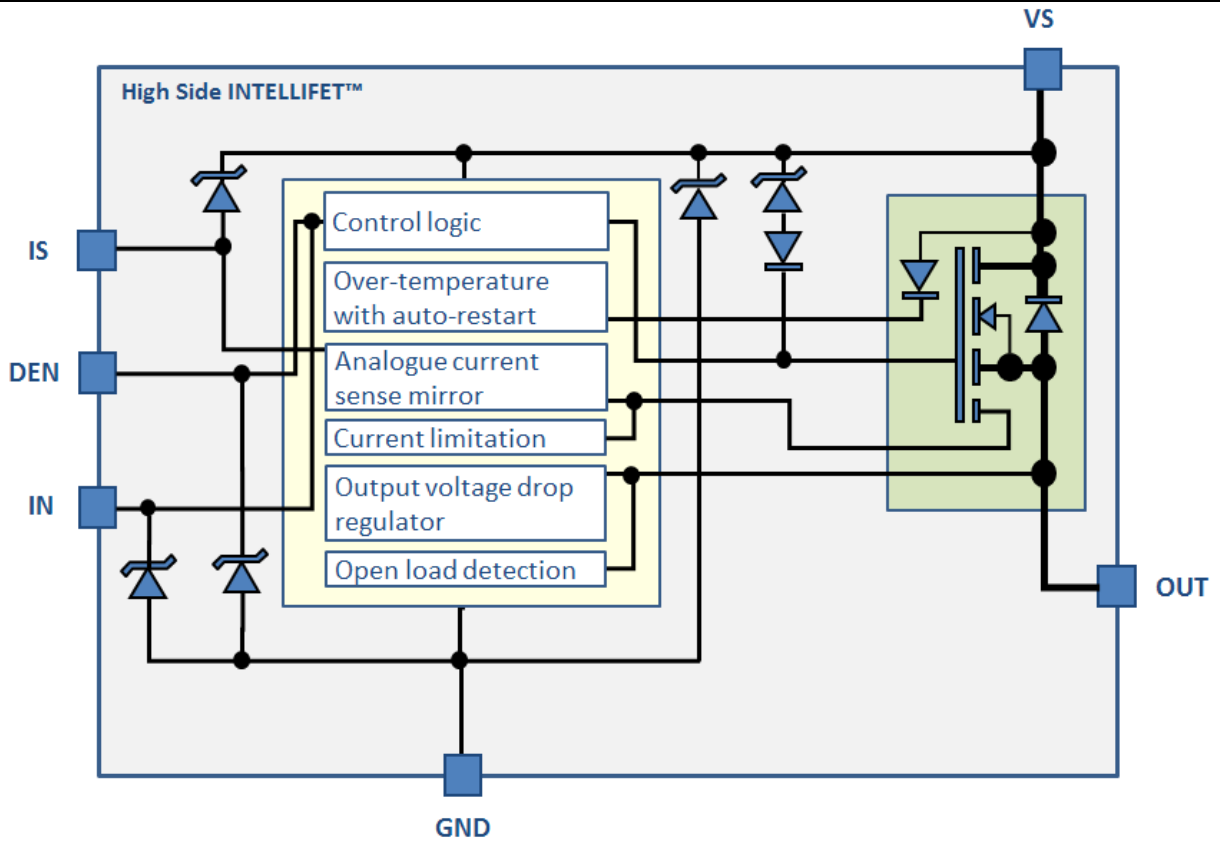

Figure 2. Functional Block Diagram of ZXMS81045

Absolute Maximum Ratings (Note 5, 6) (Unless otherwise specified $T_j = 25^\circ\text{C}$)

Symbol	Parameter	Ratings		Unit	Conditions
		MIN	MAX		
Supply voltage					
V_S	Supply voltage	-0.3	28	V	-
$V_{S(\text{REV})}$	Reverse supply voltage	0	16	V	$R_L \geq 4 \Omega$, $R_{\text{GND}} = 150 \Omega$ $T_{\text{amb}} = 25^\circ\text{C}$, $t < 2 \text{ min}$
$V_{S(\text{SC})}$	Supply voltage for short-circuit protection (Note 7)	0	24	V	-
$V_{S(\text{LD})}$	Supply voltage for load-dump protection (ISO 7637)	-	41	V	$R_{\text{IN}} = 2 \Omega$, $R_L = 4 \Omega$
Interface pins					
V_{IN}	IN pin voltage	-0.3	6	V	-
		-	7	V	$t < 2 \text{ min}$
I_{IN}	Current in IN pin	-2	2	mA	-
V_{DEN}	DEN pin voltage	-0.3	6	V	-
		-	7	V	$t < 2 \text{ min}$
I_{DEN}	Current in DEN pin	-2	2	mA	-
V_{IS}	IS pin voltage	-0.3	V_S	V	-
I_{IS}	Current in IS pin	-25	50	mA	-
Output stage					
I_L	Load current (Note 8)	-	Self-limited	A	-
P_{TOT}	Power dissipation	-	1.6	W	$T_{\text{amb}} = 85^\circ\text{C}$, $T_j < 150^\circ\text{C}$
E_{AS}	Energy dissipation (single pulse)	-	40	mJ	$V_S = 13.5 \text{ V}$, $I_L = 4 \text{ A}$ $T_j = 150^\circ\text{C}$
V_{DS}	VS to OUT pin voltage	-	41	V	-
Current					
I_{GND}	Current in GND pin	-10	10	mA	-
		-150	20	mA	$t < 2 \text{ min}$
Temperature					
T_j	Junction temperature	-40	150	$^\circ\text{C}$	-
T_{stg}	Storage temperature	-55	150	$^\circ\text{C}$	-
Electrostatic Discharge					
$V_{\text{ESD}(\text{HBM})}$	ESD capability HBM (all pins)	-2	2	kV	EIA/JESD 22-A 114B
	ESD capability HBM OUT to GND and Vs shorted	-4	4	kV	
$V_{\text{ESD}(\text{CDM})}$	ESD capability CDM	-0.75	0.75	kV	AEC-Q100

Notes:

- Operation beyond the Absolute Maximum Ratings may cause permanent damage to the device. Continued operation at the Absolute Maximum Ratings may affect device reliability
- Not subject to production test, guaranteed by design
- Short-circuit protection is outside normal operation and is limited to single pulse and allowed combinations of resistance and inductance
- Current limit is a protection feature and operation in current limitation, e.g. with Short-Circuit loads, is outside the normal operation range

Package Thermal Data

Symbol	Parameter	Min	Typ	Max	Unit
$R_{\theta JC}$	Thermal Resistance, Junction-to-Case (Note 9)	-	5.2	-	K/W
$R_{\theta JA}$	Thermal Resistance, Junction-to-Ambient mounted on PCB (Note 9, 10)	-	42	-	K/W

Notes:

9. Not subject to production test, guaranteed by design
10. Device mounted on vertical PCB, 2" x 2" x 1.6 mm, FR4 with 2oz copper for all connections

Recommended Operating Conditions

Symbol	Parameter	Min	Max	Unit
$V_{S(NOM)}$	Nominal operating supply voltage (Note 11)	8	18	V
$V_{S(OP)}$	Extended operating voltage (Note 12)	5	28	V

Notes:

11. For normal function and protection features
12. Operation across an extended range is possible but is load dependant – device may have reduced protection against faulty (overload or short-circuit) loads

Operational Electrical Characteristics Unless otherwise specified: $T_J = 25^\circ\text{C}$

Symbol	Parameter	Conditions	Min	Typ	Max	Unit
General						
$V_{S(OP)}$	Extended operating voltage (Note 13)	$V_{IN} = 4.5\text{V}, V_{DS} < 0.5\text{V}$	5	13.5	28	V
$V_{S(OP_MIN)}$	Undervoltage restart (Note 13)	$V_{IN} = 4.5\text{V}, R_L = 4\Omega$	3.8	4.2	5	V
$V_{S(UV)}$	Undervoltage shutdown (Note 13)	$V_{IN} = 4.5\text{V}, V_{DEN} = 0\text{V}$ $R_L = 4\Omega$	3	3.3	4.1	V
$V_{S(UV_HYS)}$	Undervoltage hysteresis	-	-	0.85	-	V
I_{GND}	Operating current (Note 13)	$V_{IN} = V_{DEN} = 5.5\text{V}, V_S = 18\text{V}$ device in $R_{DS(ON)}$	-	2	6	mA
$I_{S(OFF)}$	Stand-by current	V_{IN} and V_{DEN} floating, $V_{OUT} = 0\text{V}, V_S = 18\text{V}$	-	0.1	0.5	μA
		V_{IN} and V_{DEN} floating, $V_{OUT} = 0\text{V}, V_S = 18\text{V}$ $T_J = 150^\circ\text{C}$	-	3.5	-	μA
$I_{S(OFF_DEN)}$	Stand-by current with diagnostic pin active	V_{IN} floating, $V_{OUT} = 0\text{V}$ $V_S = 18\text{V}, V_{DEN} = 5.5\text{V}$	-	1	-	mA

Notes:

13. Guaranteed across temperature range with inset limits at production test

Output On-State Characteristics

The ON-state resistance $R_{DS(ON)}$ depends on the supply voltage V_S and junction temperature T_j .

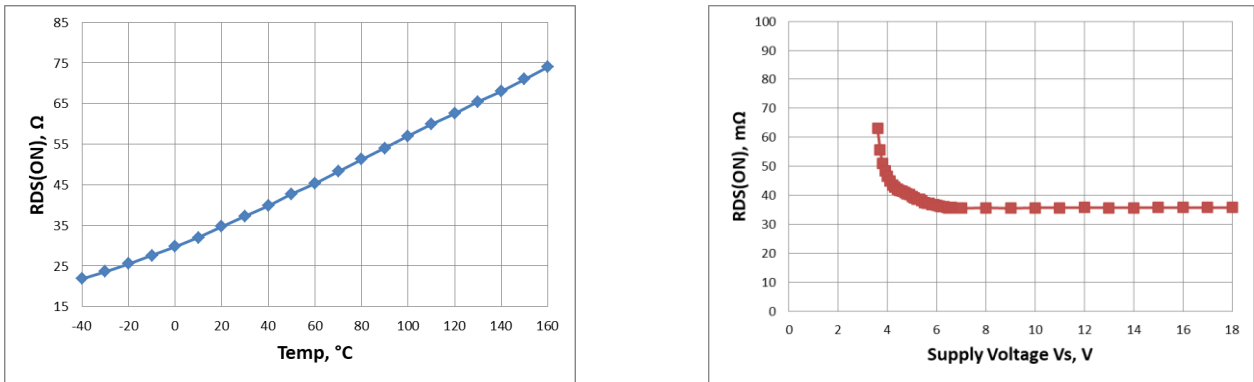

Figure 3. Typical R_{DS} ON-states Resistance

At low load current I_L the MOSFET gate drive is reduced to maintain a near constant output voltage drop $V_{DS(NL)}$. This limits the effect of internal op-amp offset voltage, to maintain useful K_{ILIS} ratio accuracy even at very low I_L .

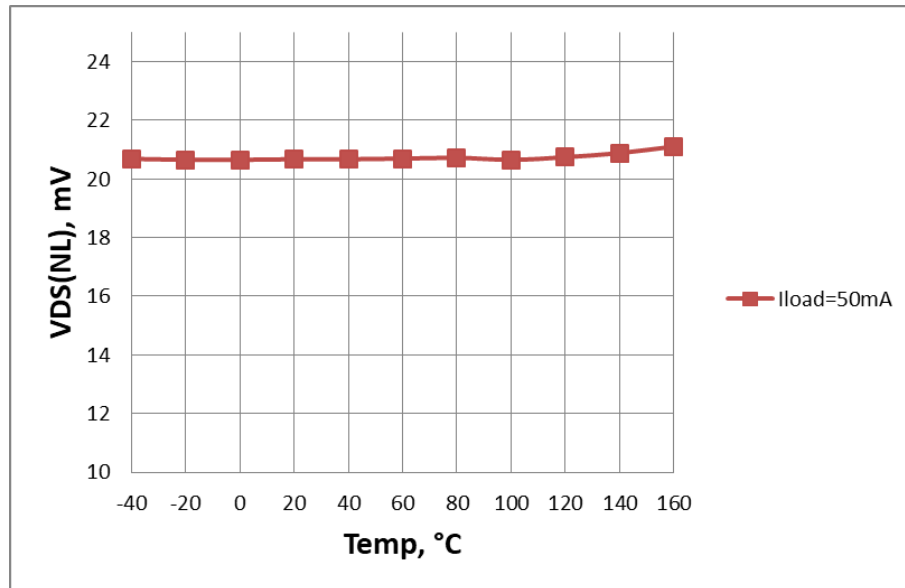

Figure 4. Voltage Drop Regulation

Resistive Load Switching

The power MOSFET turn-ON and turn-OFF processes are determined by the device itself, with rates suitable for EMC compatibility.

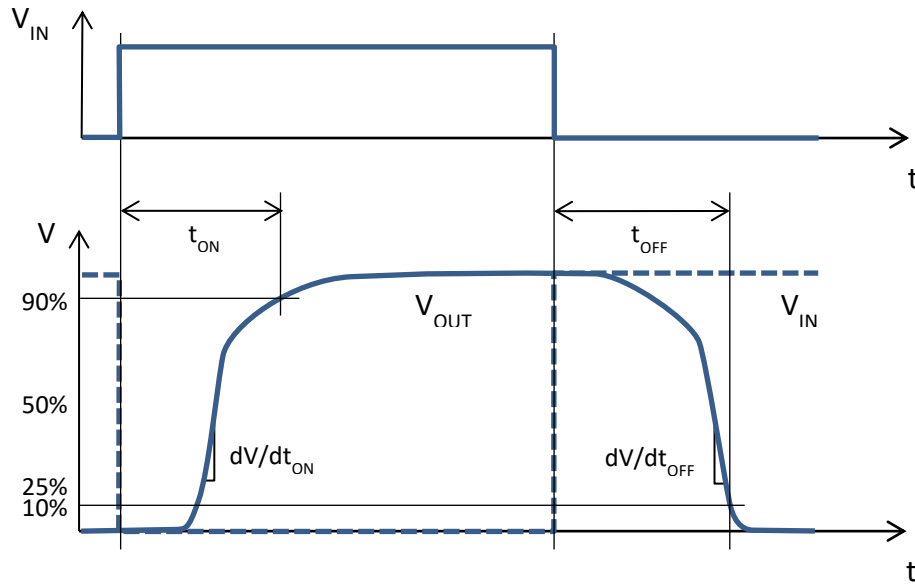

Figure 5. Switching a Resistive Load

Output Inductive Load clamp

To de-energise inductive loads the OUT terminal must be allowed to swing below ground (V_{OUT} rings negative) during the OFF-state.

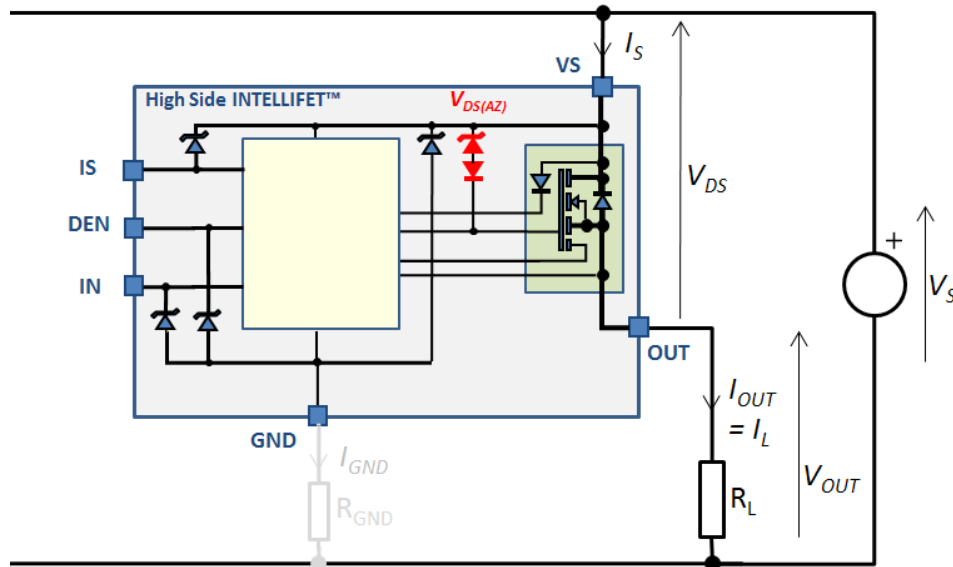

Figure 6. Output Clamp

A low-impedance active voltage clamp uses the MOSFET channel to limit the maximum voltage across the MOSFET drain-source terminals, limiting the swing of OUT below V_S to safe $V_{DS(AZ)}$. This prevents avalanche of the MOSFET or associated circuitry.

Resistive Load Switching (continued)

The power MOSFET turn-ON and turn-OFF processes are determined by the device itself, with rates suitable for EMC compatibility.

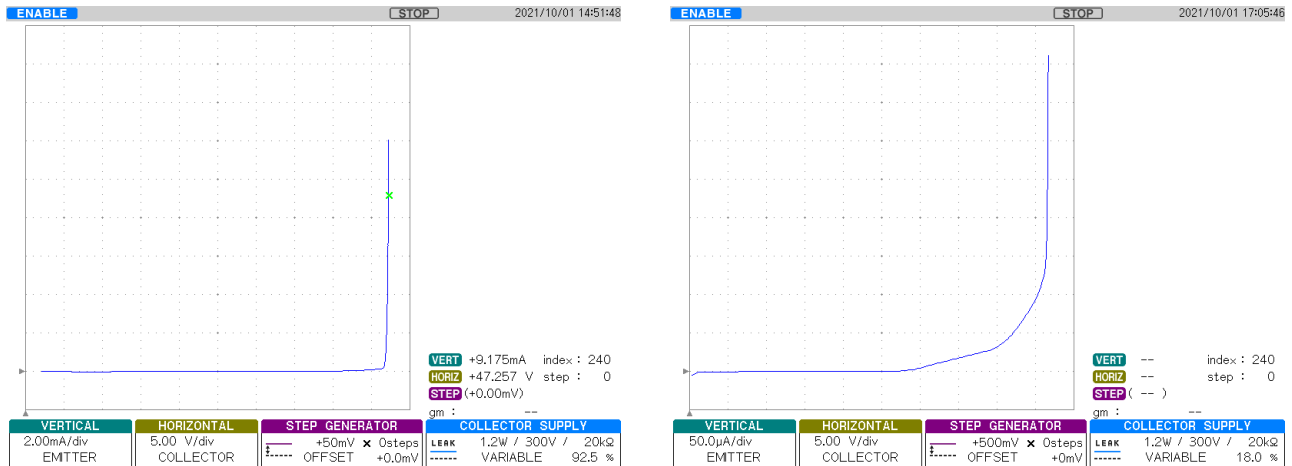

Figure 7. Typical V_{DS} Clamp Characteristic

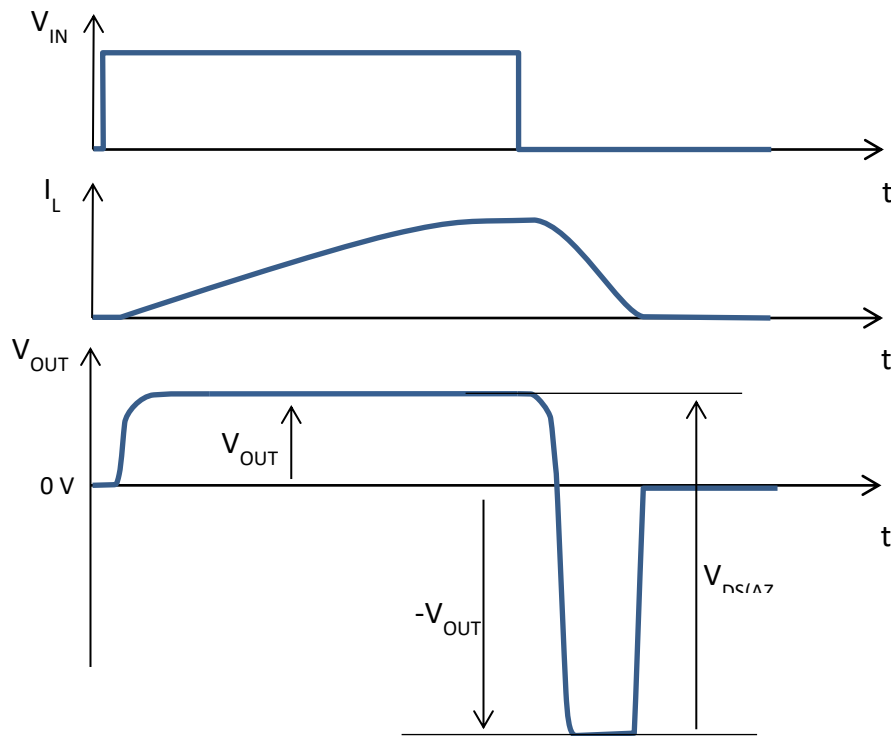

Figure 8. Switching an Inductive Load

Maximum Load inductance

Stored inductive load ring-OFF energy is dissipated in the MOSFET during switching and load ring-off clamping. Additional energy is also supplied to the system by the V_s supply until the load current I_L reaches zero. This causes a temporary rise in MOSFET temperature after turn-OFF begins. The temperature reached depends on the starting temperature, thermal environment, load current I_L , load inductance L_L , load resistance R_L and supply voltage V_s .

Inverse Current Capability

In the ON-state the device will remain on if the output current becomes inverse until or unless the inverse current becomes high enough to create a $-V_{DS}$ approaching body diode conduction. During inverse current conduction, $I_{L(INV)}$, the IS sense output will be zero. If body diode conduction occurs all functions are disabled or unspecified until the inverse current becomes very small.

If inverse current is present in the OFF-state body diode conduction occurs and all functions are disabled or unspecified. When inverse current is removed or becomes very small then turn-ON and normal function become possible.

Power Stage Electrical Characteristics

Unless otherwise specified: $8V < V_S < 18V$, $T_j = 25^\circ C$; typical values based on $V_S = 13.5V$

Symbol	Parameter	Conditions	Min	Typ	Max	Unit
Output Characteristics						
R _{DS(ON)}	ON-state resistance (Note 14)	V _{IN} = 4.5V, I _L = 4A T _j = 150°C	-	73	90	mΩ
		V _{IN} = 4.5V, I _L = 4A	-	34	45	mΩ
I _{L(NOM)}	Nominal load current (Notes 15,16)	T _{amb} = 85°C, T _j < 150°C	-	4	-	A
V _{DS(NL)}	Voltage drop regulation at low I _L	I _L = 50mA	-	25	40	mV
V _{DS(AZ)}	Output clamp voltage	I _L = 20mA	41	47	53	V
I _{L(OFF)}	Output leakage current	V _{IN} floating, V _{OUT} = 0V	-	0.1	0.5	μA
		V _{IN} floating, V _{OUT} = 0V T _{amb} = 150°C	-	3	-	μA
I _{L(INV)}	Inverse output current (Note 16)	V _S < V _{OUT}	-	3	-	A
Timings						
dV/dt _{ON}	Slew rate ON, 30% to 70% V _S	R _L = 4Ω, V _S = 13.5V	0.1	0.25	0.5	V/μs
dV/dt _{OFF}	Slew rate OFF, 70% to 30% V _S		0.1	0.25	0.5	V/μs
t _{ON}	Turn-ON time to 90% V _S		30	90	230	μs
t _{OFF}	Turn-OFF time to 10% V _S		30	170	230	μs
t _{ON(DELAY)}	Turn-ON delay to 10% V _S		10	25	100	μs
t _{OFF(DELAY)}	Turn-OFF delay to 90% V _S		10	95	150	μs
E _{ON}	Switch ON energy	R _L = 4Ω, V _S = 18V V _{OUT} = 90% V _S	-	0.8	-	mJ
E _{OFF}	Switch OFF energy	R _L = 4Ω, V _S = 18V V _{OUT} = 10% V _S	-	0.7	-	mJ

Notes:

- 14. Guaranteed across temperature range with inset limit at production test
- 15. Device mounted on vertical 50 x 50 1.5 mm FR4 single-sided PCB with 6cm² 2 oz copper in free air
- 16. ON-state reverse conduction, functional test only

Protection Features

Loss of Ground Protection

The device will turn off in the case that the ground pin connection is lost and the load remains connected. It is recommended to use high ohmic input resistors in the interface pins to ensure that the device is turned off by limiting the current in the paths from the ground pin, through the input and diagnostic enable ESD diodes, to the external driving circuits.

Undervoltage Protection

The device will not turn on if the V_s supply voltage is below the minimum operating voltage $V_{S(OP)}$ where protection functions may not be operational. If the device is already on then the supply voltage has to drop to below the undervoltage threshold $V_{S(UV)}$ to turn the output off. Figure 9 shows the undervoltage mechanism.

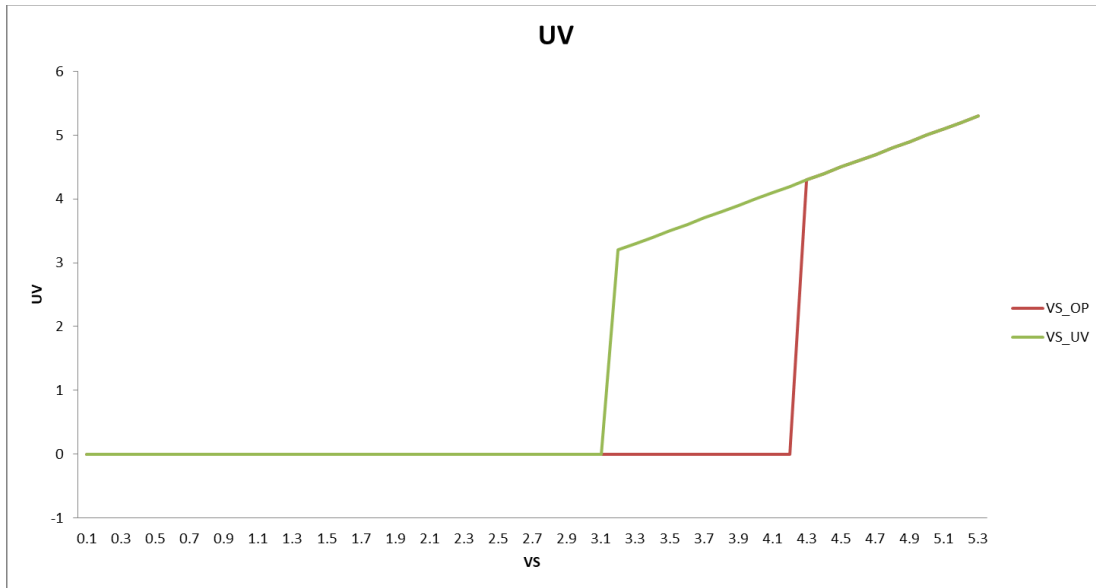

Figure 9. Undervoltage Behavior

Protection Features (continued)

Overvoltage Protection

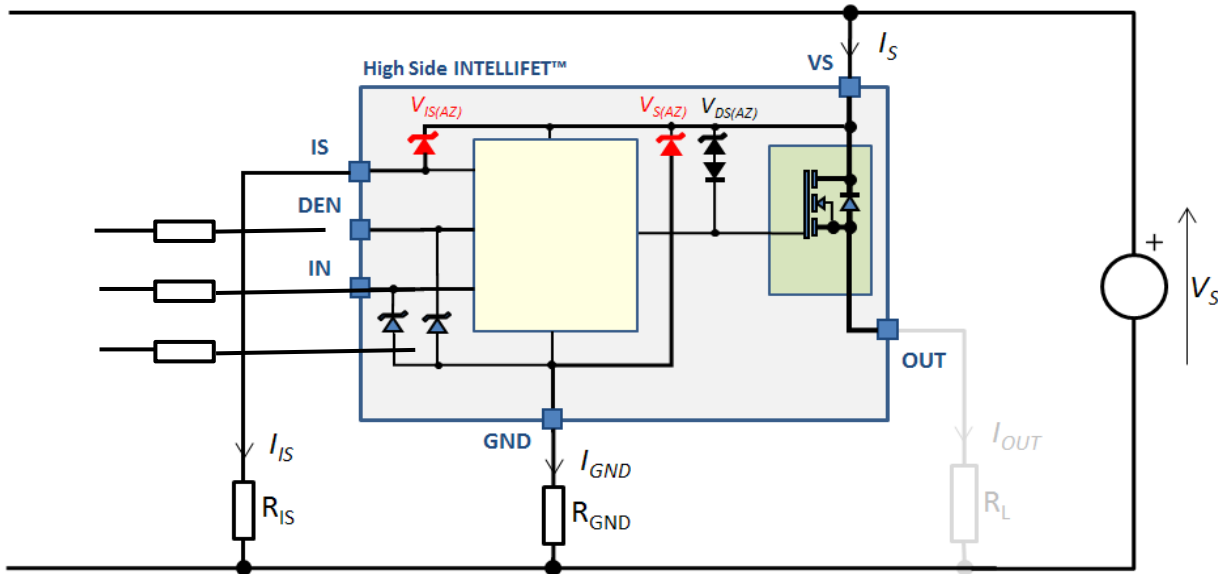

Figure 10. Overvoltage Clamping Circuit

The GND pin has an active protection clamp, operating much as a low noise high voltage Zener device, to protect it from overvoltage for high V_S transients. During V_S transient overvoltage the voltage is clamped and the excess voltage, $V_S - V_{S(AZ)}$, is applied across the ground resistor R_{GND} raising the potential on the GND pin. Additional high ohmic series resistors may be needed to prevent high V_{IN} and V_{DEN} being applied directly to the driving circuits.

The IS pin also has an active protection clamp and during V_S transient overvoltage the voltage is clamped and excess voltage, $V_S - V_{IS(AZ)}$, is applied across the sense resistor R_{IS} . An additional high ohmic series resistor may be needed in the application to prevent high V_{IS} being applied directly to the application monitoring circuit.

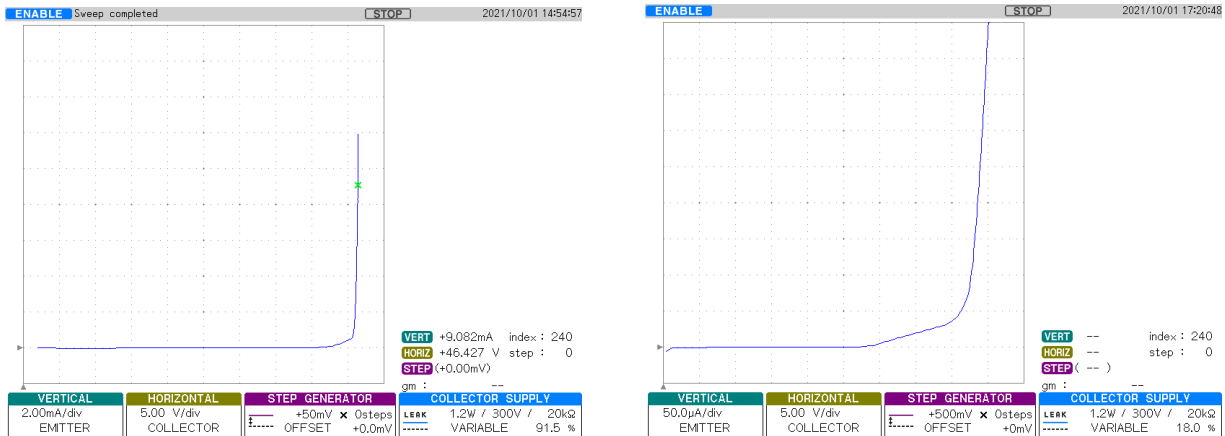

Figure 11. Typical $V_S - V_{IS}$ Clamp Characteristic

Also during V_S overvoltage transient the voltage $V_S - OUT$ is clamped and the excess voltage, $V_S - V_{DS(AZ)}$, is applied across the load R_L . $V_S - OUT$ is the same clamp described under the earlier section.

Protection Features (continued)

Overload Protection

During overload the output current is limited to a value depending on the V_{DS} voltage resulting in high dissipation in the output power stage. Sustained operation in this mode will raise the internal junction temperature until dynamic or absolute overtemperature protection cycling begins. There is a dynamic ($\Delta T_{J(SW)}$) and an absolute ($T_{J(SC)}$) temperature sensor. See Figure 12.

If the temperature rise of the power stage versus the cooler control area exceeds $\Delta T_{J(SW)}$ then the device will be turned off until the rise falls to a reset level. Each cycle causes the absolute temperature to slightly increase.

If the absolute temperature reaches $T_{J(SC)}$ then the device will be turned off until the absolute temperature falls by $\Delta T_{J(SC)}$. The device will continue to cycle to $T_{J(SC)}$ as long as the fault condition remains.

I_S outputs continuous $I_{S(FAULT)}$ during: current limitation; dynamic overtemperature cycling; and absolute overtemperature cycling.

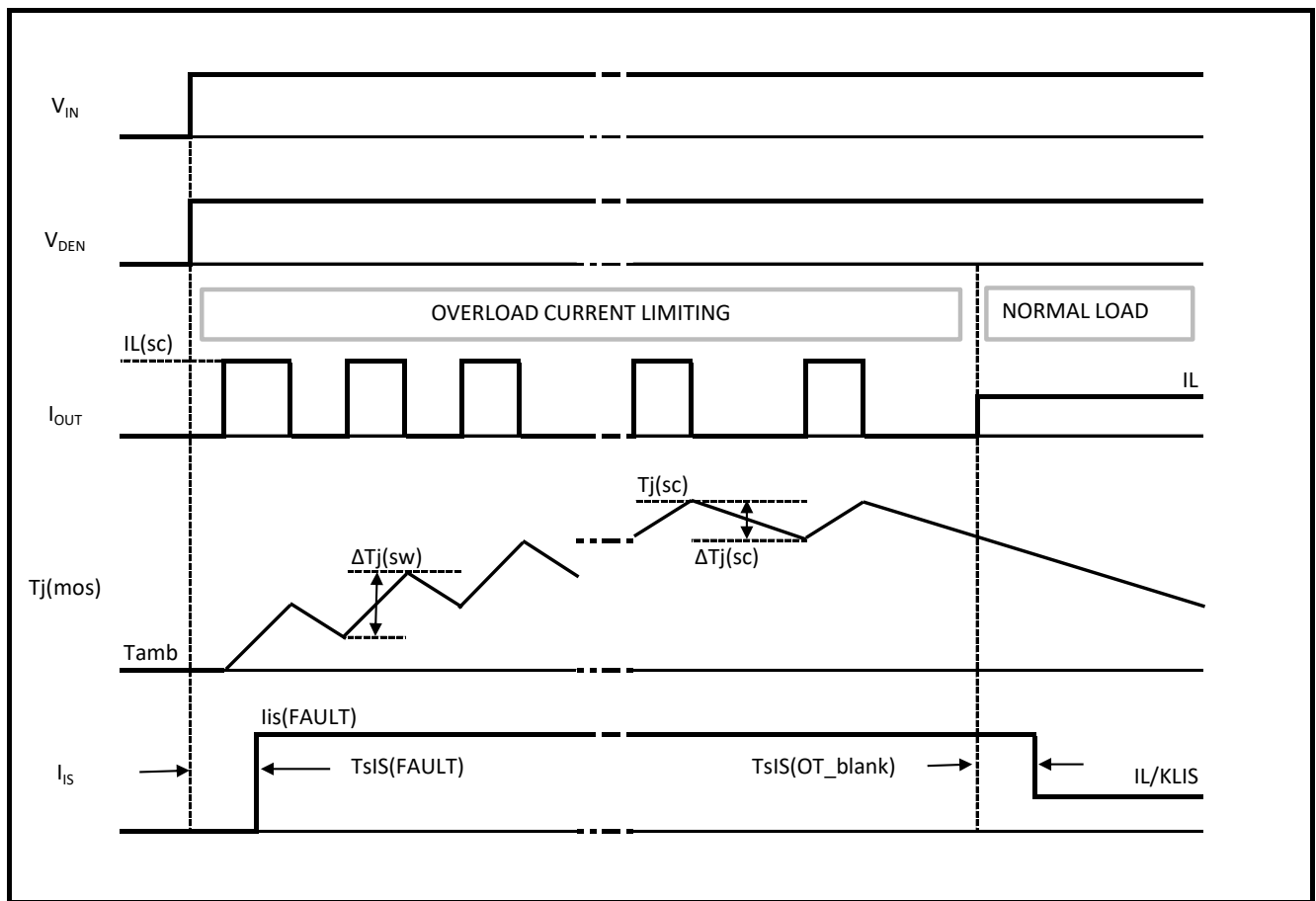

Figure 12. Overload Protection Diagram

Protection Electrical Characteristics

Unless otherwise specified: $8V < V_S < 18V$, $T_j = 25^\circ\text{C}$; typical values based on $V_S = 13.5V$

Symbol	Parameter	Conditions	Min	Typ	Max	Unit
Loss of Ground Protection						
$I_{\text{OUT(GND)}}$	Output leakage current (Note 17)	$V_S = 28V$, GND disconnected	-	0.1	-	mA
Reverse Battery Protection						
$V_{\text{DS(REV)}}$	Reverse output voltage (Note 18)	$I_L = -2A$	0.5	0.8	1	V
Overvoltage Protection						
$V_{\text{S(AZ)}}$	V_S to GND clamping	$I_S = 5mA$	41	47	53	V
Overload Protection						
$I_{\text{L5(SC)}}$	Load current limit	$V_{\text{DS}} = 5V$	25	32	40	A
$I_{\text{L28(SC)}}$	Load current limit (Note 17)	$V_{\text{DS}} = 28V$	-	16	-	A
$I_{\text{L(RMS)}}$	Load current during overtemperature cycling (Note 17)	$R_{\text{SHORT}} = 0.1\Omega$ $L_{\text{SHORT}} = 5\mu\text{H}$	-	4	-	A
$\Delta T_{\text{J(SW)}}$	Dynamic temperature rise during cycling (Note 19)	-	-	40	-	K
$T_{\text{J(SC)}}$	Thermal shutdown temperature (Note 19)	-	150	170	200	$^\circ\text{C}$
$\Delta T_{\text{J(SC)}}$	Thermal hysteresis (Note 19)	-	-	20	-	K

Notes:

17. Not subject to production test, guaranteed by design
18. During inverse operation, where $I_L < 0A$ and $V_S > 0V$, the body-drain diode will conduct with a voltage drop $V_{\text{DS(REV)}}$.
19. Functional test only at $T_j = 150^\circ\text{C}$

Diagnostic Functionality – Detailed Description

In normal operation, the IS pin outputs a small analogue sense current proportional to the main OUT current flowing in the power MOSFET. In the case where it is disabled by the DEN pin, it becomes high impedance.

During overload / current-limit operation / overtemperature / high temperature gradient or open load in the OFFstate, the IS pin outputs a defined current $I_{S(FAULT)}$ greater than normal sense currents for normal loads.

During ON-state operation with open load, normal OFF-state, or OFF-state with inductive load ring-off current still flowing, the IS current is approximately zero.

Operating Condition	V _{IN}	V _{DEN}	V _{OUT}	IS output current, I _S
Normal operation	L	H	Z	Z
	H	H	H	$= I_L / K_{ILIS}$
Current limiting	H	H	H	$I_{S(FAULT)}$
Short circuit OUT to GND	L	H	L	Z
	H	H	L	$I_{S(FAULT)}$
Overtemperature	L	H	Z	Z
	H	H	Z	$I_{S(FAULT)}$
Short circuit OUT to V _S	L	H	H	$I_{S(FAULT)}$
	H	H	H	$< I_L / K_{ILIS}$ (Note 20)
Open load	L	H	$< V_{OL(OFF)}$	Z
	L	H	$> V_{OL(OFF)}$	$I_{S(FAULT)}$
	H	H	H	$< I_{S(OL)}$ (Note 21)
Inverse load current	L	H	H	$I_{S(FAULT)}$
	H	H	H	$I_{S(OL)}$
All	X	L	X	Z

Table 2. Operational Truth Table (Note 22)

Notes:

- 20. A low resistance short between OUT and V_{bb} will reduce the output current, I_L and therefore reduce the analogue sense current, I_S
- 21. With external pull-up resistor
- 22. H = high level; L = low level; Z = high impedance, voltage depends on external circuit; X = don't care

Diagnostic Diagrams

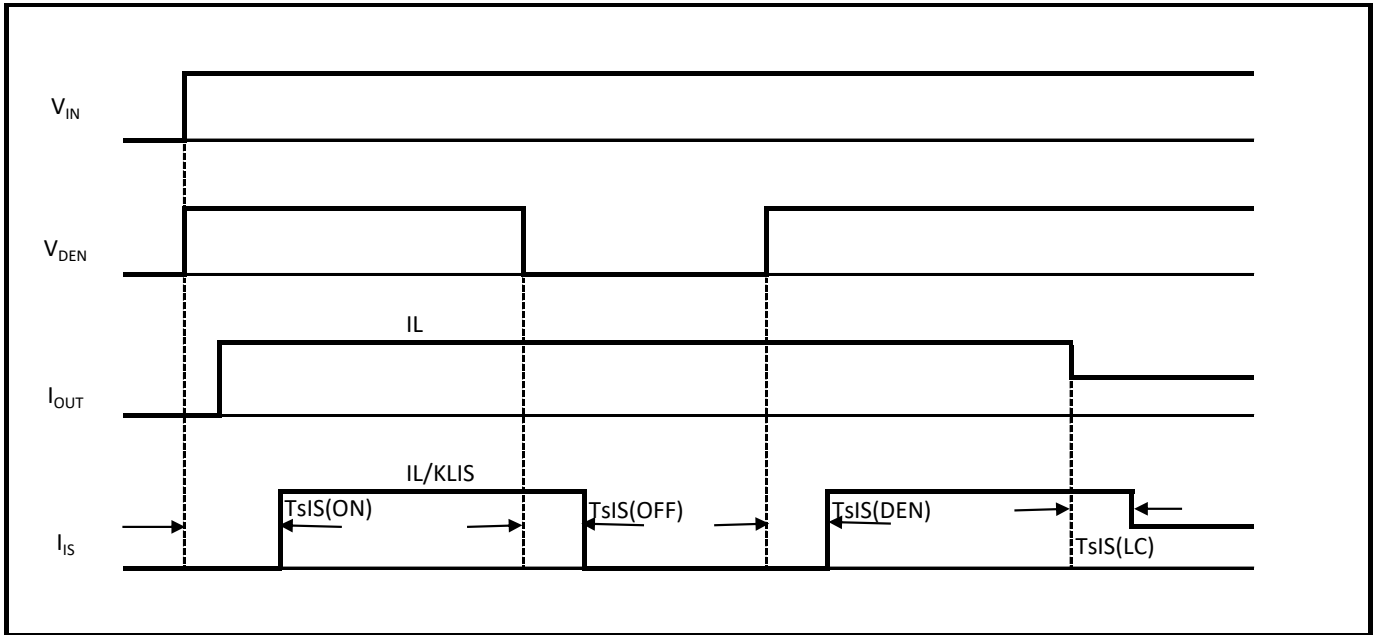

Figure 13. IS Signal Timing Diagram

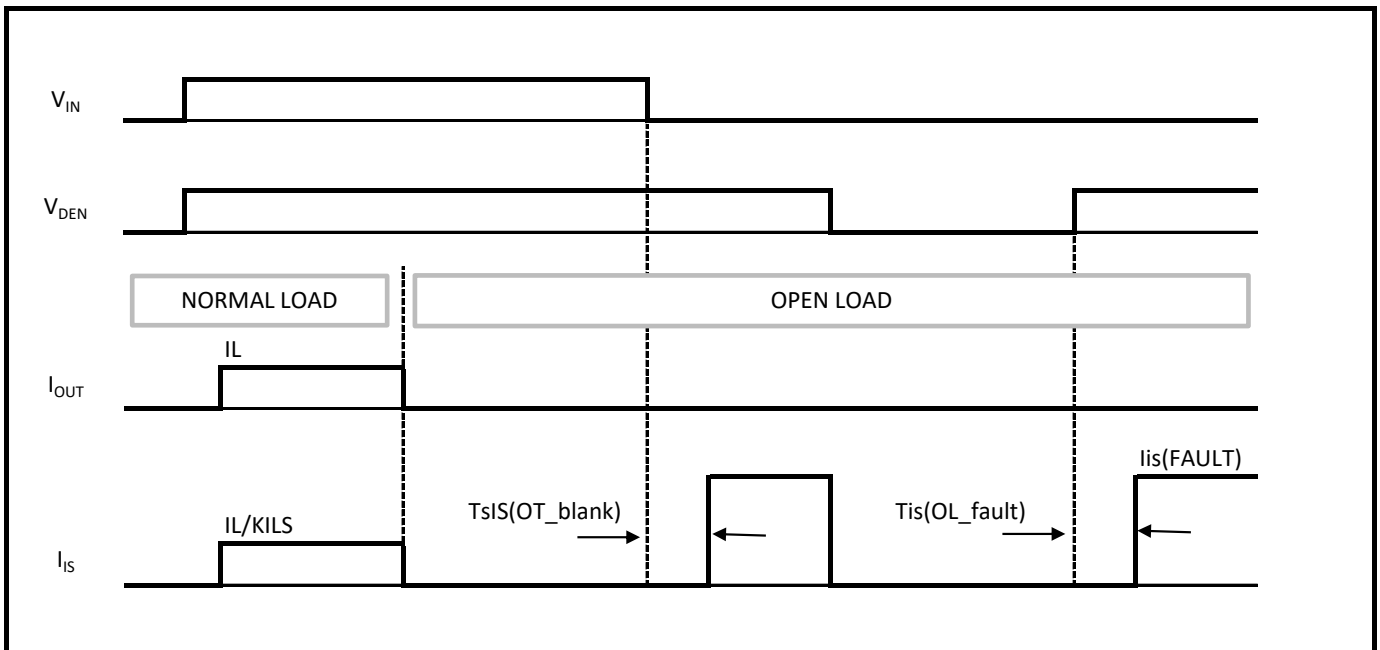

Figure 14. Signal Open Load Timing Diagram

Diagnostic Electrical Characteristics

Unless otherwise specified: $8V < V_S < 18V$, $T_J = 25^\circ C$; typical values based on $V_S = 13.5V$

Symbol	Parameter	Conditions	Min	Typ	Max	Unit
Open Load Detection						
$V_{DS(OL)}$	Open load OFF state detection voltage	$V_{IN} = 0V$, $V_{DEN} = 4.5V$	3.5	-	4.5	V
$I_{L(OL)}$	Open load ON state detection current	$V_{IN} = V_{DEN} = 4.5V$ $I_{S(OL)} = 8\mu A$	5	-	30	mA
Current Sense Pin						
$I_{S(DIS)}$	Current sense leakage current	$V_{IN} = 4.5V$, $V_{DEN} = 0V$ $I_L = 4A$	-	-	1	μA
$V_{IS(SAT)}$	VS to IS saturation voltage	$V_{IN} = 0V$, $V_{DEN} = 4.5V$ $I_{IS} = 6mA$, $V_{OUT} = V_S > 10V$	-	-	3	V
$I_{S(FAULT)}$	Current sense under fault conditions	$V_{IN} = V_{IS} = 0V$, $V_{DEN} = 4.5V$ $V_{OUT} = V_S > 10V$	6	15	35	mA
$V_{IS(AZ)}$	VS to IS clamp voltage	$I_{IS} = 5mA$	41	47	53	V
Load Current Sense						
K_{ILIS0}	Sense current ratio $I_L = 50mA$	$V_{IN} = V_{DEN} = 4.5V$	-23%	1200	+23%	-
K_{ILIS1}	Sense current ratio $I_L = 0.5A$		-24%	1200	+24%	-
K_{ILIS2}	Sense current ratio $I_L = 1A$		-18%	1200	+18%	-
K_{ILIS3}	Sense current ratio $I_L = 2A$		-9%	1200	+9%	-
K_{ILIS4}	Sense current ratio $I_L = 4A$		-5%	1230	+5%	-
ΔK_{ILIS}	Sense current ratio variation $I_L = 2A$ versus $I_L = 1A$		-9%	0%	+9%	-
Diagnostic Timings						
$t_{sIS(ON)}$	Current sense settling time to 90% I_{IS} after IN and DEN high (Note 23)	$V_S = 13.5V$, $I_L = 2A$ $R_{IS} = 1.2k\Omega$	-	-	250	μs
$t_{sIS(DEN)}$	Current sense settling time to 90% I_{IS} after DEN high	$V_S = 13.5V$, $V_{IN} = 4.5V$ $I_L = 2A$, $R_{IS} = 1.2k\Omega$	-	-	20	μs
$t_{sIS(LC)}$	Current sense settling time to 90% I_{IS} after load current change	$V_S = 13.5V$, $V_{IN} = V_{DEN} = 4.5V$ $I_L = 1A$ to $2A$, $R_{IS} = 1.2k\Omega$	-	-	20	μs
$t_{sIS(OL_FAULT)}$	Diagnostic fault current settling time to 90% $I_{S(FAULT)}$ after DEN high with OFF state open load condition	$V_{IN} = 0V$, $V_{OUT} = V_S = 13.5V$ $R_{IS} = 1.2k\Omega$	-	-	150	μs
$t_{sIS(FAULT)}$	Diagnostic fault current settling time to 90% $I_{S(FAULT)}$ after IN and DEN high with overload condition	$V_{DS} = 5V$, $R_{IS} = 1.2k\Omega$	-	-	250	μs
$t_{sIS(OT_blank)}$	Diagnostic fault current off delay time to 90% $I_{S(FAULT)}$ after overtemperature condition returning to normal operation	$V_{IN} = V_{DEN} = 4.5V$ $R_{IS} = 1.2k\Omega$ (Note 23)	-	150	-	μs
$t_{sIS(OFF)}$	Current sense fall time to < 50% I_{IS} after DEN low	$V_{IN} = 4.5V$, $I_L = 2A$ $R_{IS} = 1.2k\Omega$	-	-	30	μs

Notes:

23. Not subject to production test, guaranteed by design

Input Pins

The input circuit is compatible with 3.3V and 5V logic levels. The input diode provides ESD protection. If the pin is left open, the internal tie down resistor will keep the output off. A Schmitt trigger provides switching hysteresis to avoid an undefined state if there is a slowly rising or falling voltage on the IN pin. Figure 15 shows the electrical equivalent circuit.

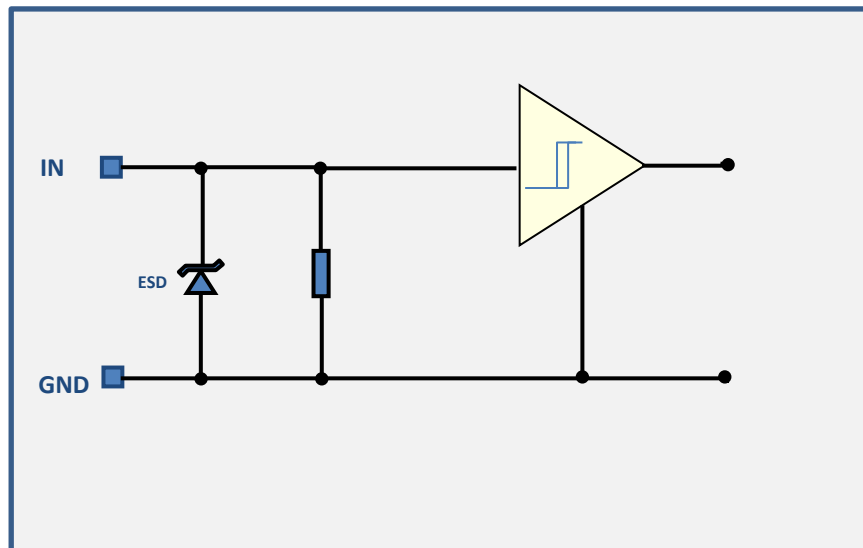

Figure 15. Input Pin Circuitry

The DEN pin has the same circuitry as the IN pin above.

Input Electrical Characteristics

Unless otherwise specified: $8V < V_S < 18V$, $T_j = 25^\circ C$; typical values based on $V_S = 13.5V$

Symbol	Parameter	Conditions	Min	Typ	Max	Unit
IN Pin						
$V_{IN(L)}$	Low level input voltage	-	-0.3	-	0.8	V
$V_{IN(H)}$	High level input voltage	-	2	-	6	V
$V_{IN(hys)}$	Input voltage hysteresis	-	-	0.25	-	V
$I_{IN(L)}$	Low level input current	$V_{IN} = 0.8V$	1	3	25	μA
$I_{IN(H)}$	High level input current	$V_{IN} = 5.5V$	2	8	25	μA
DEN Pin						
$V_{DEN(L)}$	Low level input voltage	-	-0.3	-	0.8	V
$V_{DEN(H)}$	High level input voltage	-	2	-	6	V
$V_{DEN(hys)}$	Input voltage hysteresis	-	-	0.25	-	V
$I_{DEN(L)}$	Low level input current	$V_{DEN} = 0.8V$	1	3	25	μA
$I_{DEN(H)}$	High level input current	$V_{DEN} = 5.5V$	2	8	25	μA

Characterization

General Product Characterization

Minimum Function supply Voltage

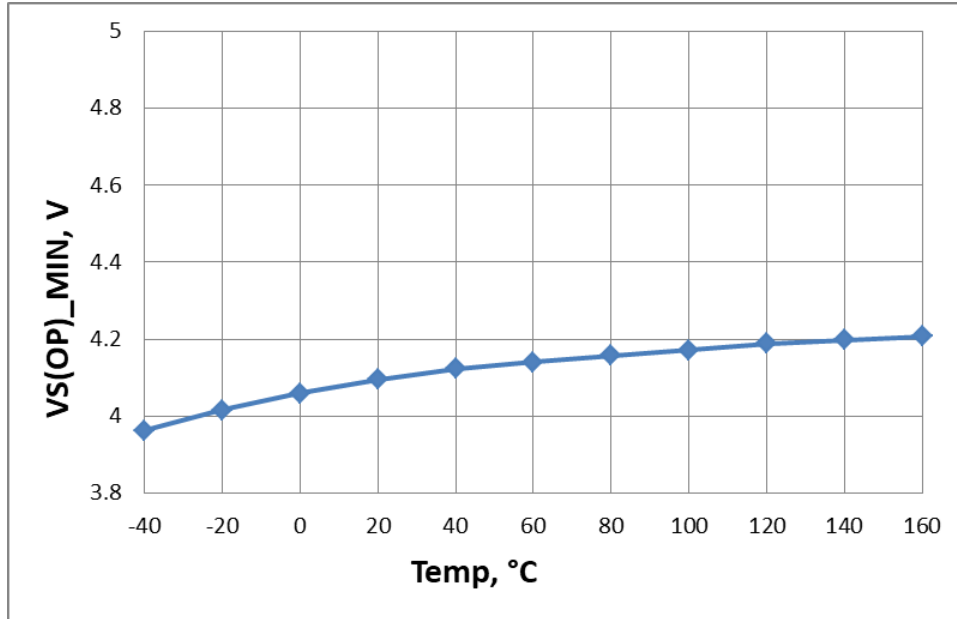

Figure 16. Minimum Function Supply Voltage $V_{S(OP_min)}=f(T_J)$

Undervoltage Shutdown.

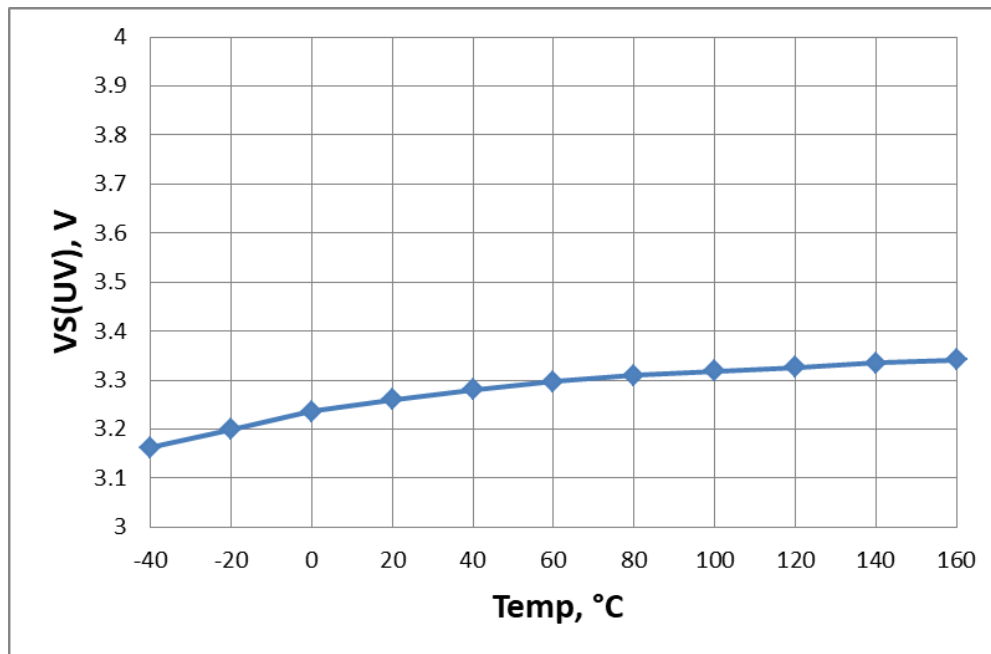

Figure 17. Undervoltage Threshold $V_{S(UV)}=f(T_J)$

Characterization (continued)

Current Consumption Channel Active

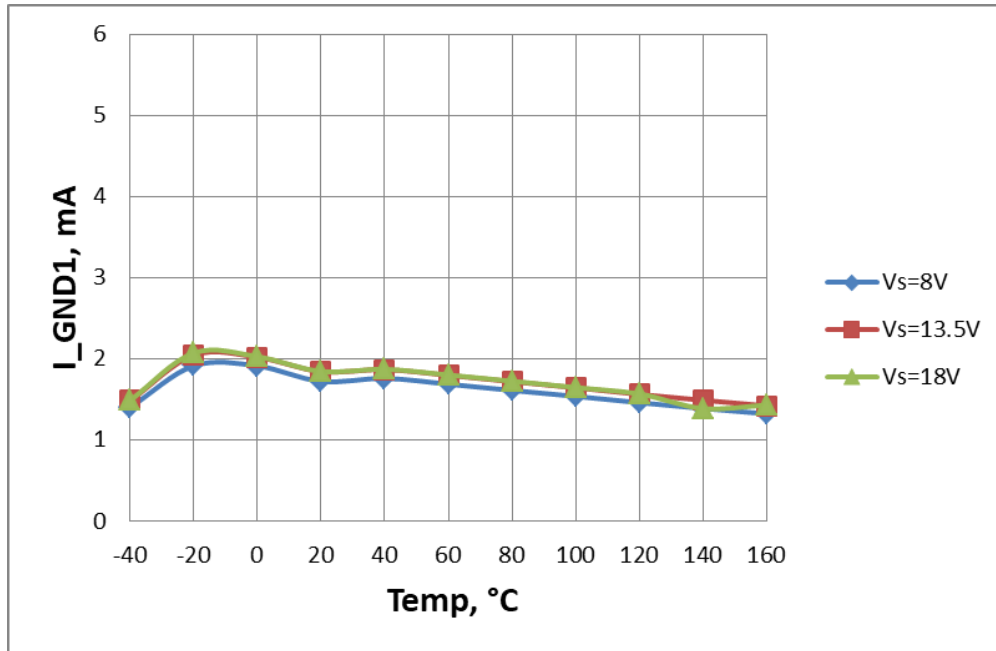

Figure 18. Current Consumption for Whole Device with Load, Channel Active $I_{GND_1} = f(T_J; V_S)$

Standby Current for Whole Device with Load

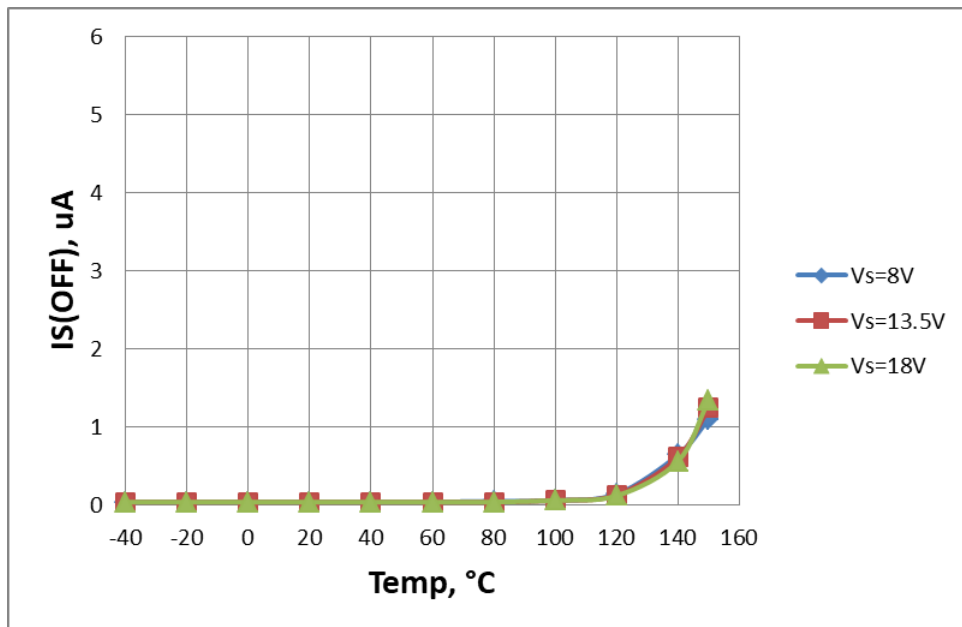

Figure 19. Standby Current for Whole Device with Load. $I_{S(OFF)} = f(T_J; V_S)$

Characterization (continued)

Power Stage

Output Voltage Drop Limitation at Low Load Current

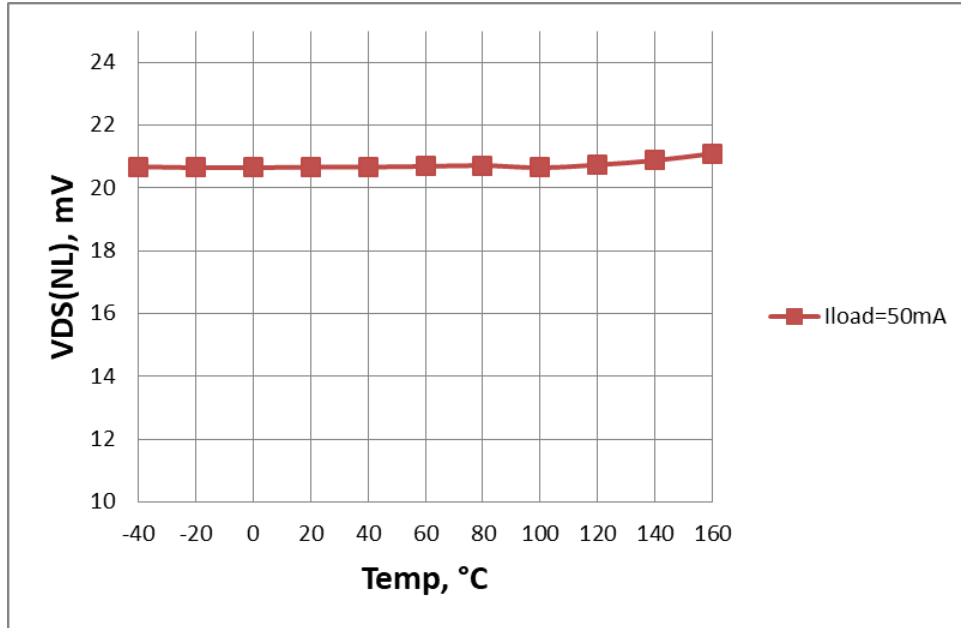

Figure 20. Output Voltage Drop Limitation at Low Load Current $V_{DS(NL)} = f(T_J; V_S)$

Characterization (continued)

Power stage ON/OFF Slew Rate
Slew Rate at Turn ON.

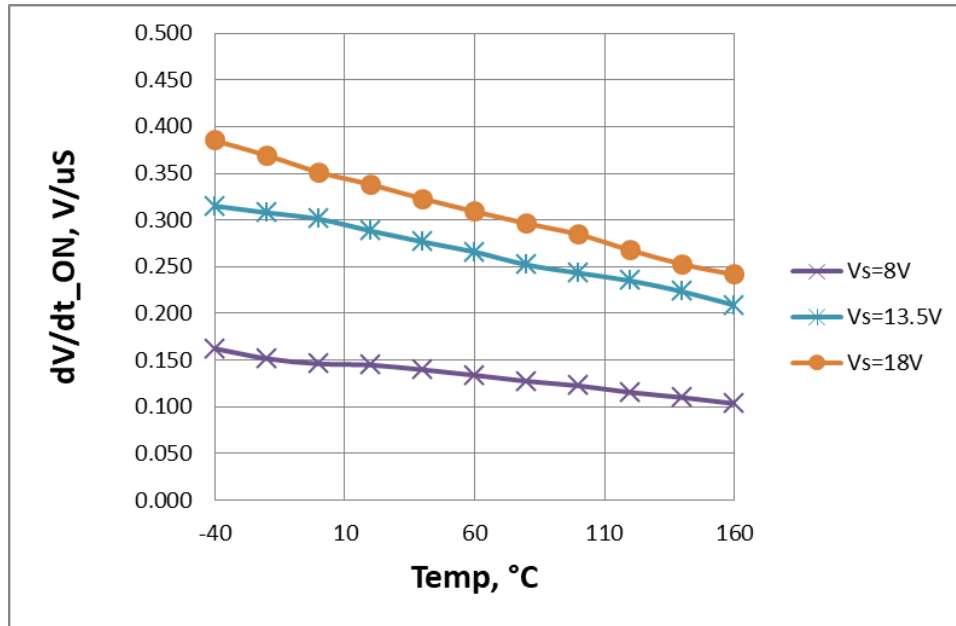

Figure 21. Slew Rate at Turn ON $dV/dt_{ON} = f(T_J; V_S)$, $R_L=4\Omega$.

Slew Rate at Turn OFF.

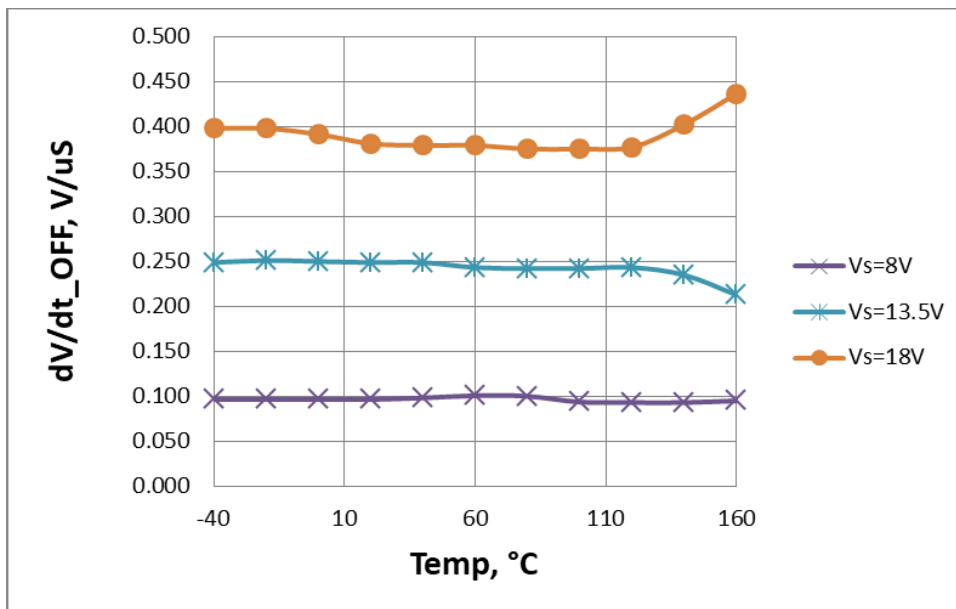

Figure 22. Slew Rate at Turn OFF $dV/dt_{OFF} = f(T_J; V_S)$, $R_L=4\Omega$.

Characterization (continued)

Power Stage ON/OFF Timing
Turn ON Timing

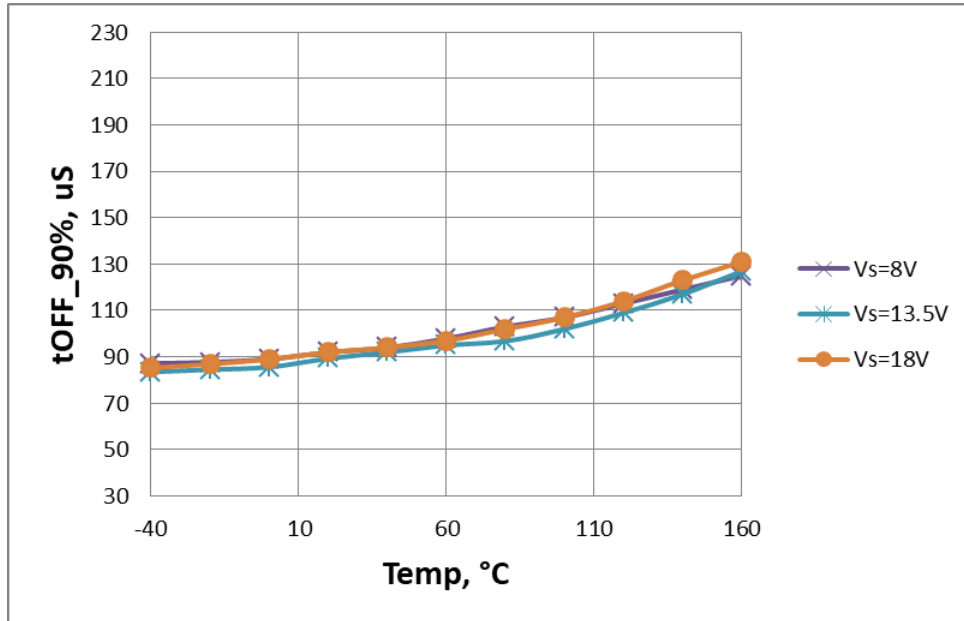

Figure 23. Turn ON $t_{ON} = f(T_J; V_s)$, $R_L = 4\Omega$.

Turn OFF timing.

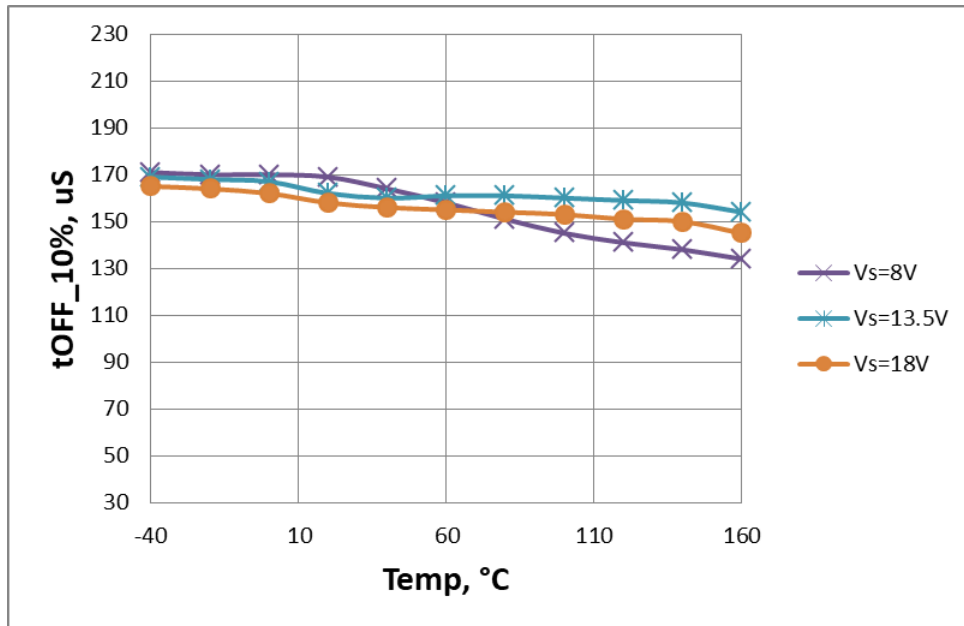

Figure 24. Turn ON $t_{ON} = f(T_J; V_s)$, $R_L = 4\Omega$.

Characterization (continued)

Turn ON/OFF Matching

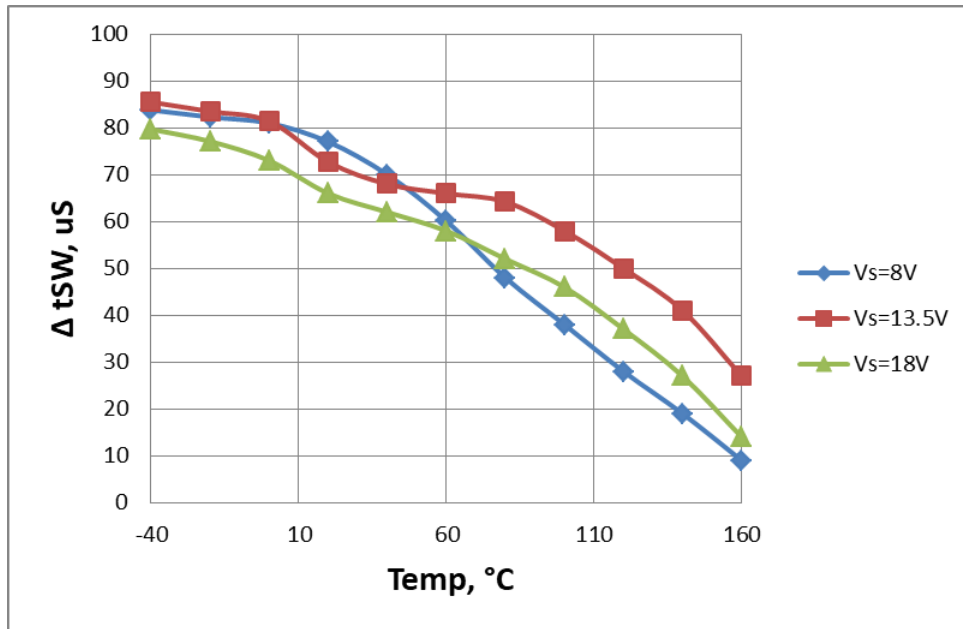

Figure 25. Turn ON / OFF matching $\Delta t_{sw} = f(T_J; V_s)$, $R_L=4\Omega$.

Characterization (continued)

Power stage ON/OFF Energy

Switch ON Energy

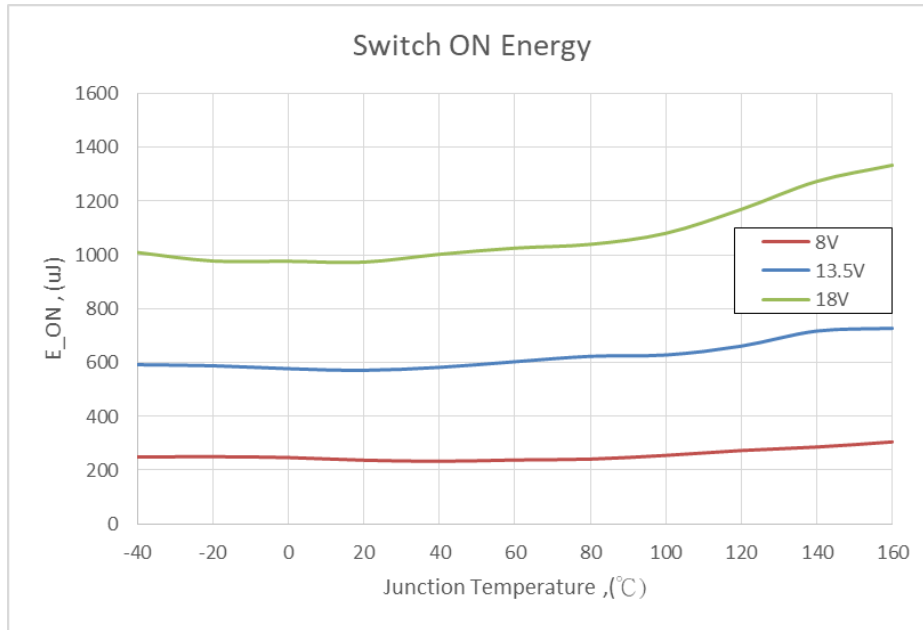

Figure 26. Switch ON Energy $E_{ON} = f(T_J; V_s)$, $R_L=4\Omega$.

Switch OFF Energy.

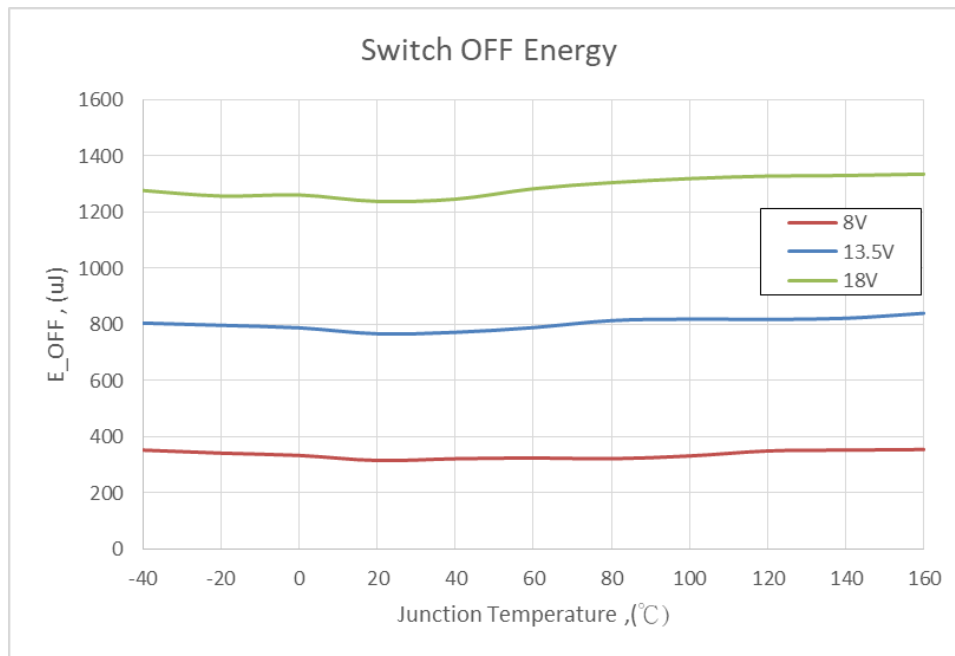

Figure 27. Switch OFF Energy $E_{OFF} = f(T_J; V_s)$, $R_L=4\Omega$.

Characterization (continued)

Protection Function

Overload Condition in the Low Voltage Area

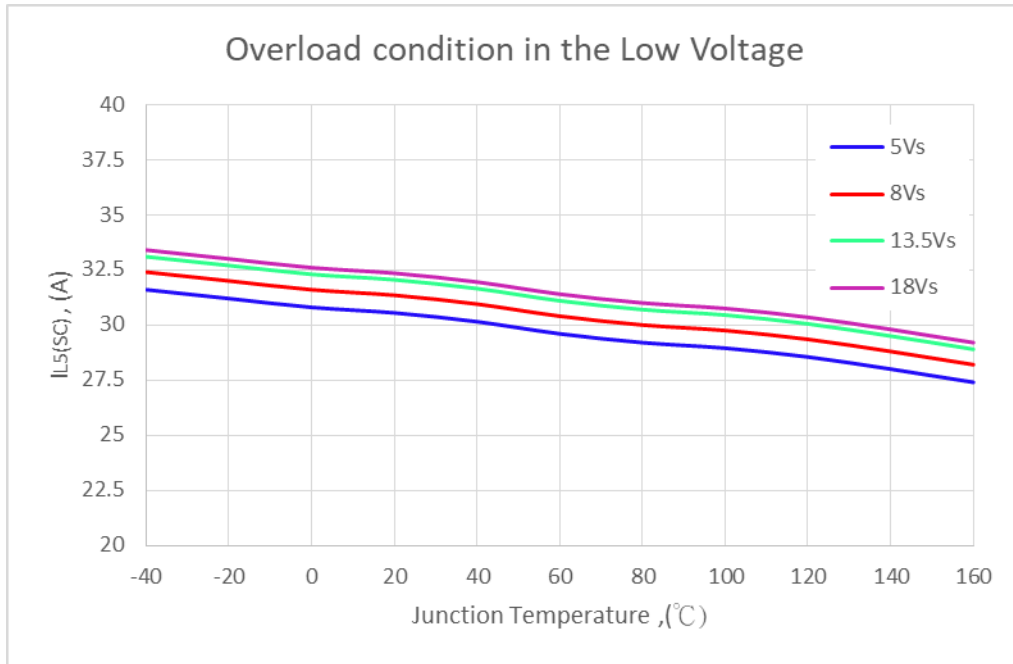

Figure 28. Overload Condition in the Low Voltage Drop Area $I_{L5(SC)} = f(T_J; V_s)$, $R_L = 4\Omega$.

Overload Condition in the High Voltage Area.

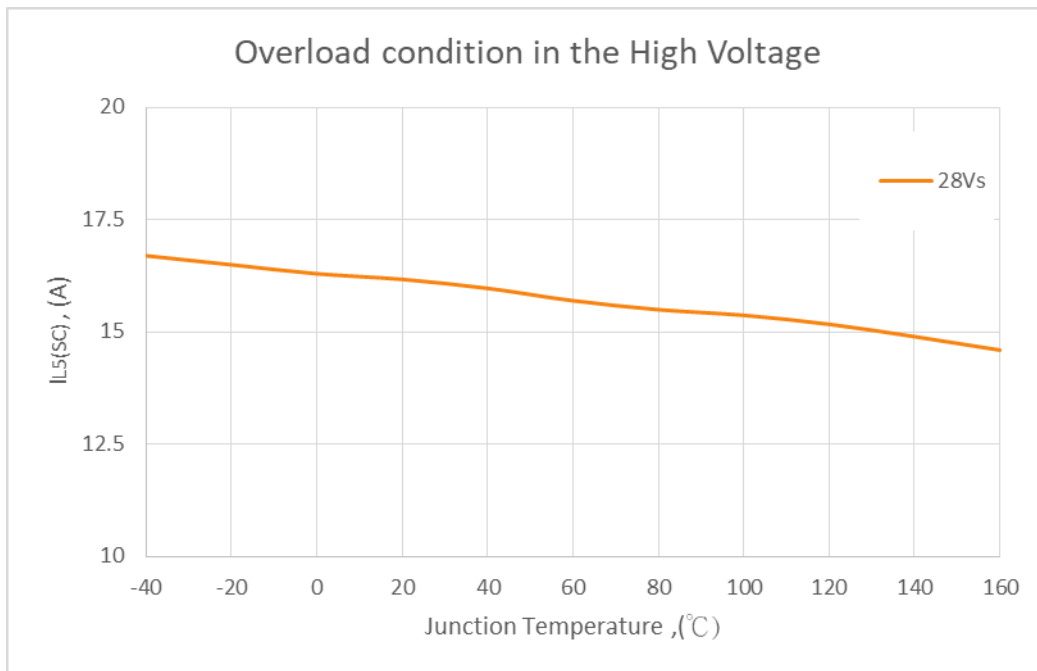

Figure 29. Overload Condition in the High Voltage Drop Area $I_{L5(SC)} = f(T_J; V_s)$, $R_L = 4\Omega$.

Characterization (continued)

Diagnostic Mechanism
Current Sense at No Load.

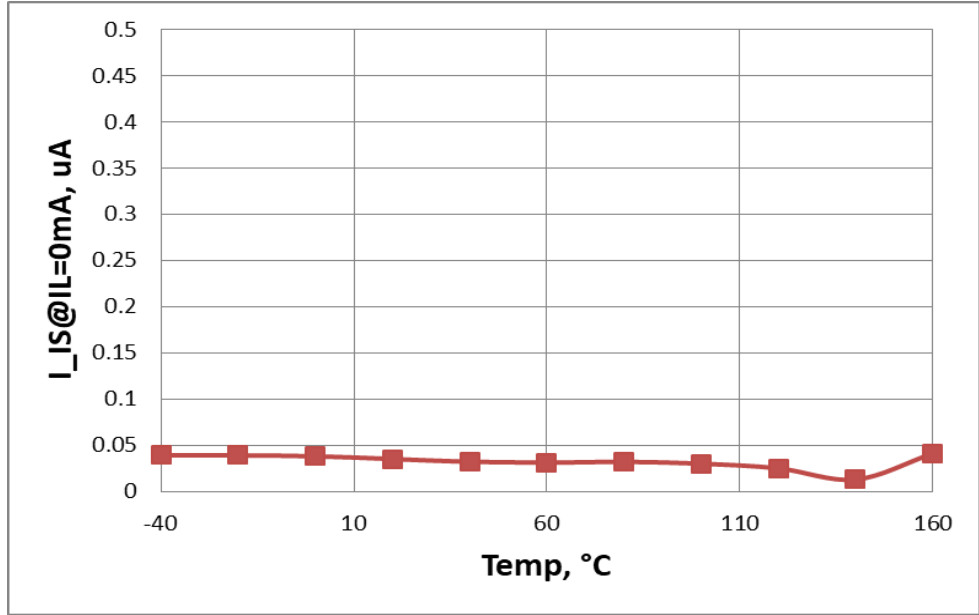

Figure 30. Current Sense at no Load $I_{IS} = f(T_J; V_S)$.

Open Load Detection Threshold in ON State

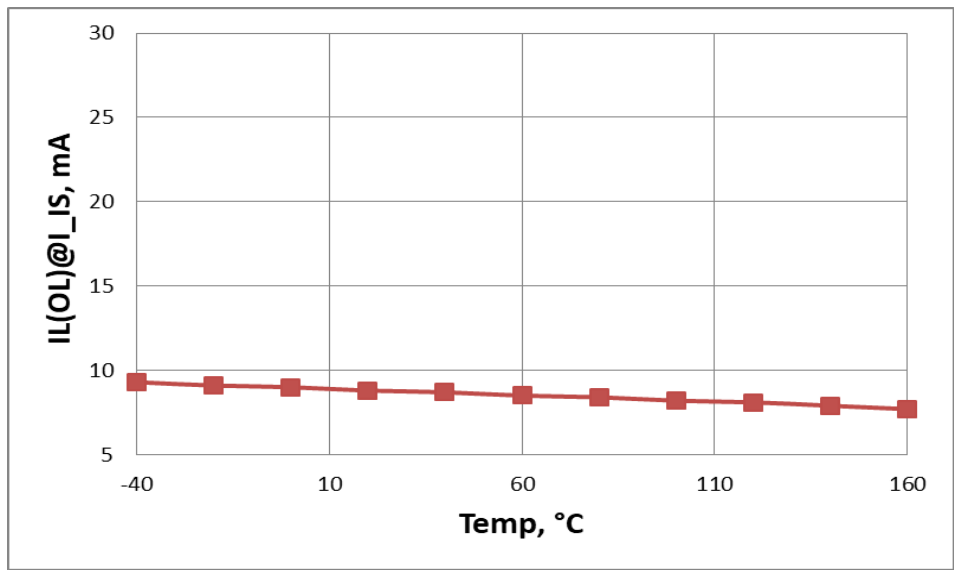

Figure 31. Open Load Detection ON State Threshold $I_{L(OL)} = f(T_J; V_S)$

Characterization (continued)

Sense Signal Maximum Voltage

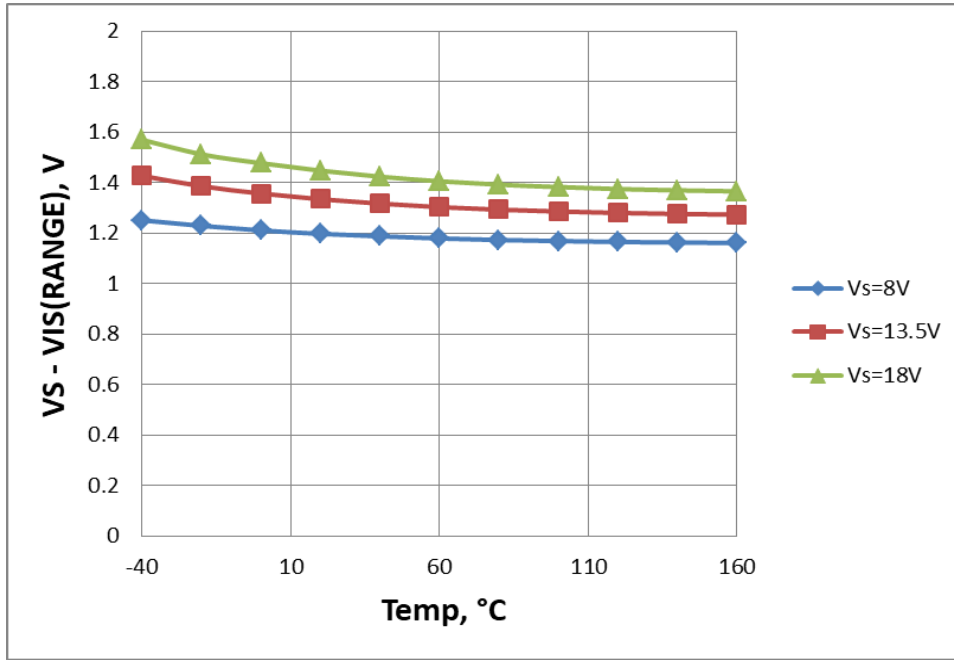

Figure 32. Sense Signal Maximum Voltage $V_S - V_{IS(RANGE)} = f(T_J; V_S)$.

Sense Signal Maximum Current.

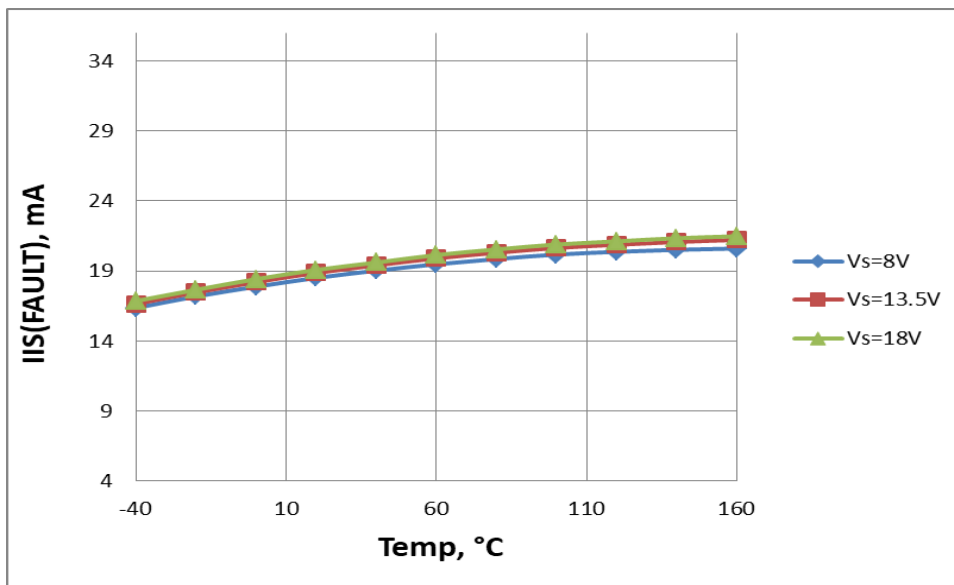

Figure 33. Sense Signal Maximum Current in Fault Condition $I_{IS(FAULT)} = f(T_J; V_S)$

Characterization (continued)

Input Pins
Input Voltage Threshold ON to OFF

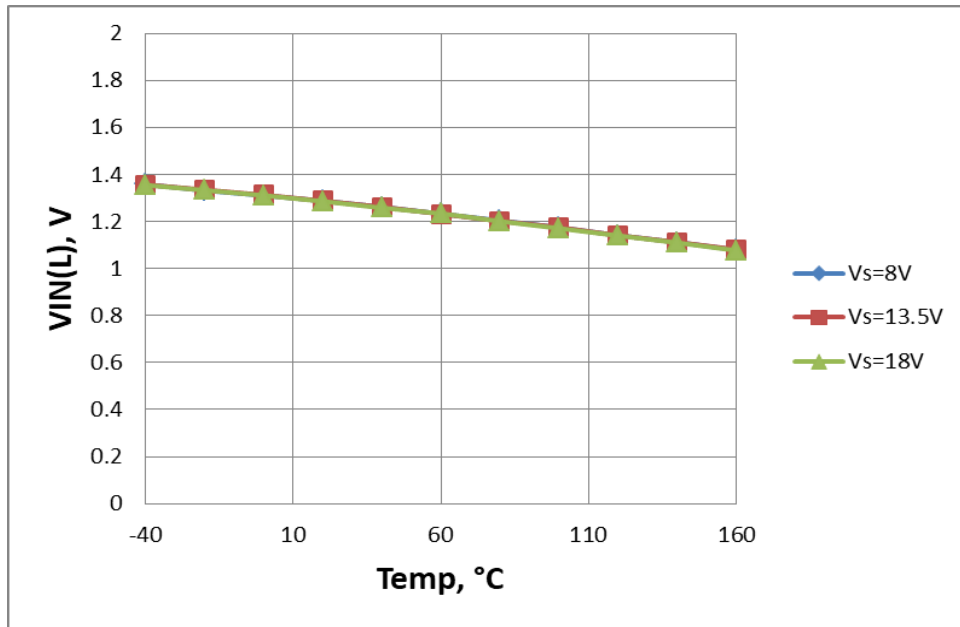

Figure 34. Input Voltage Threshold $V_{IN(L)} = f(T_J; V_S)$.

Input Voltage Threshold OFF to ON.

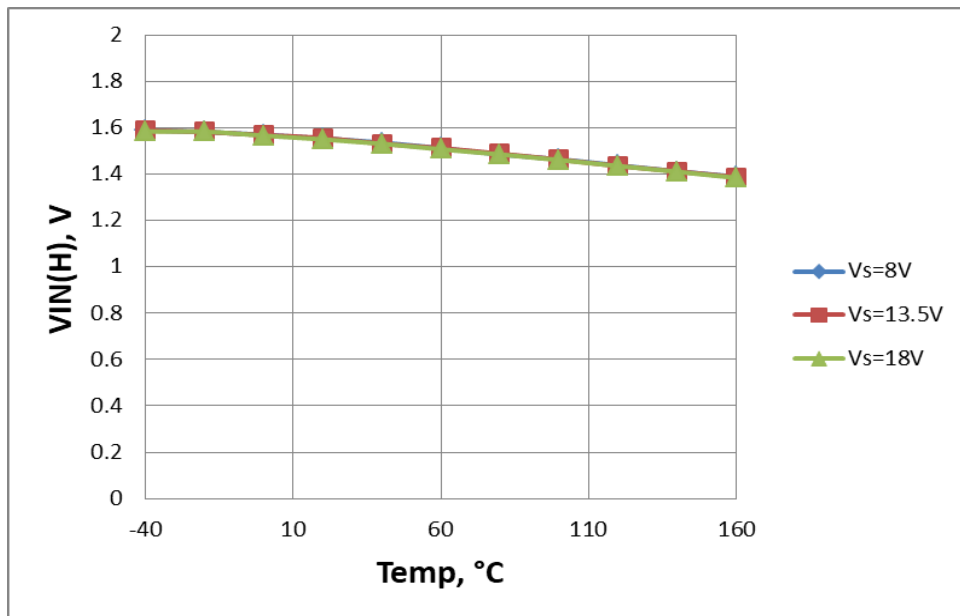

Figure 35. Input Voltage Threshold $V_{IN(H)} = f(T_J; V_S)$

Characterization (continued)

Input Voltage Hysteresis

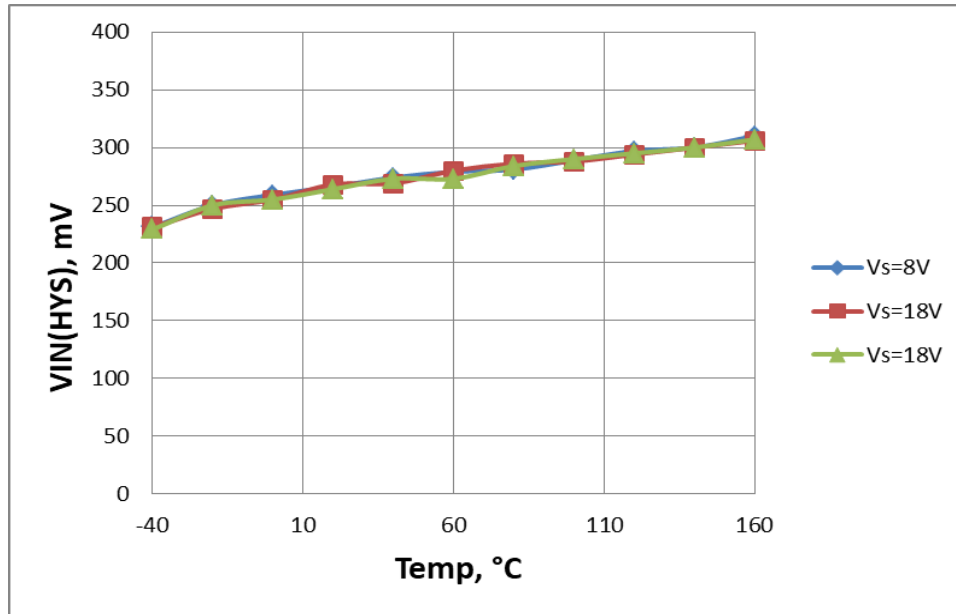

Figure 36. Input Voltage Hysteresis $V_{IN(HYS)} = f(T_J; V_S)$.

Input Current High Level.

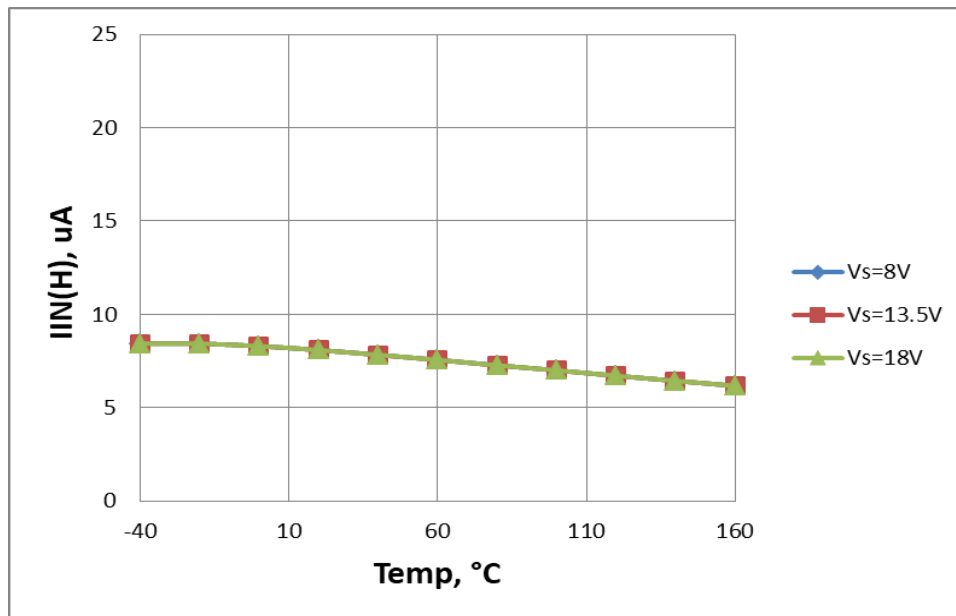

Figure 37. Input Current High Level $I_{IN(H)} = f(T_J; V_S)$

Application Information (Note 24)

Note: The following information is given as a hint for the implementation of the device only and shall not be regarded as a description or warranty of a certain functionality, condition or quality of the device.

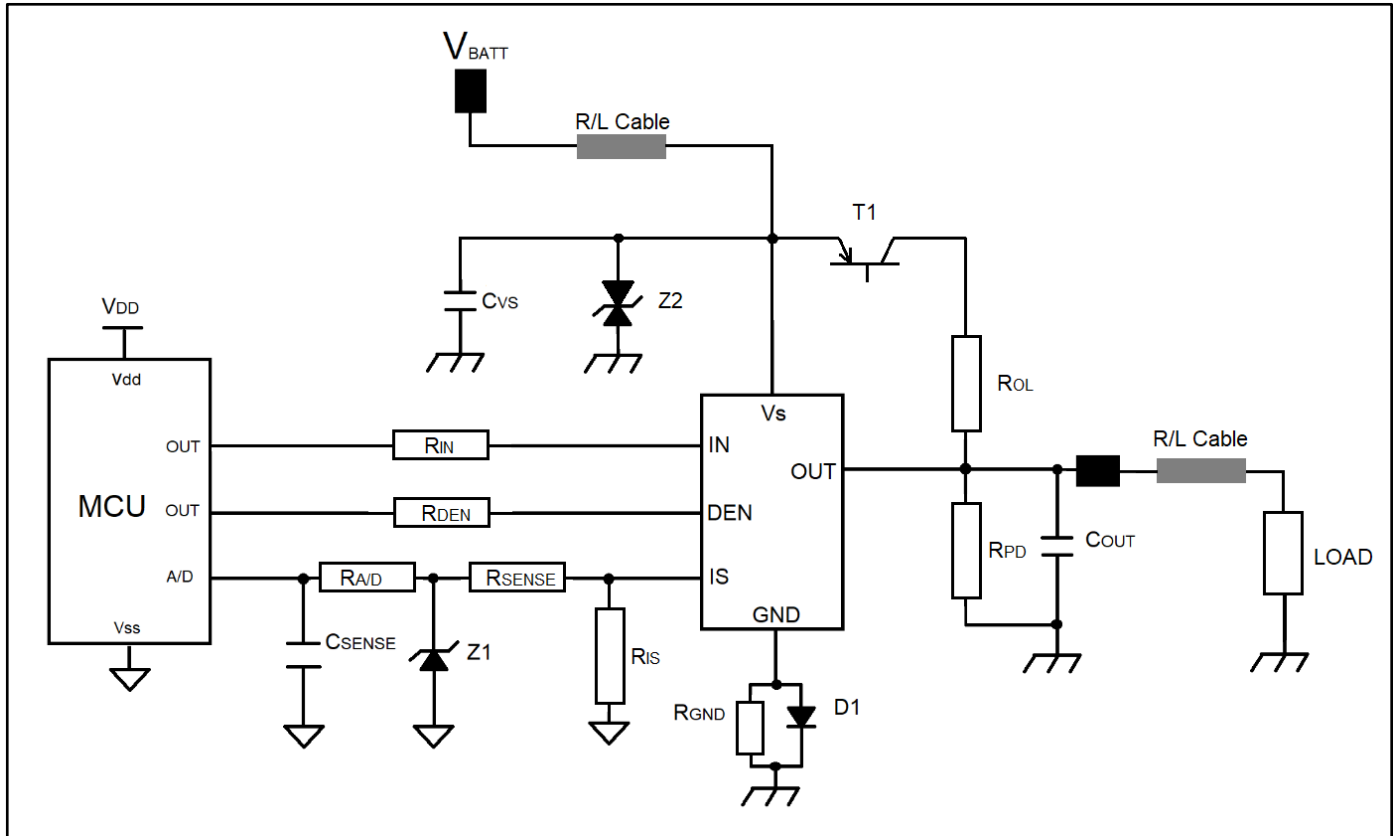

Figure 38. Application Diagram

Note:
24. This is a very simplified example of an application circuit. The function must be verified in the real application.

Table 3. Bill of Materials

Reference	Value	Purpose
RIN	4.7 kΩ	Connect to the micro controller for overvoltage, reverse polarity protections
RDEN	4.7 kΩ	Connect to the micro controller for overvoltage, reverse polarity protections
RPD	47 kΩ	Improve immunity to electromagnetic noise
RIS	1 kΩ	Sense resistor
RSENSE	4.7 kΩ	Overvoltage, reverse polarity, loss of ground. Value to be tuned with micro controller specification.
ROL	1.5 kΩ	For open load in OFF diagnostic
RA/D	4.7 kΩ	Protection of the micro controller during overvoltage, reverse polarity
RGND	1 kΩ	To keep the device GND at a stable potential during clamping
D1	BAS21	Protection of the device during reverse polarity
Z1	7 V Zener diode	Protection of the micro controller during overvoltage
Z2	36 V Zener diode	Protection of the device during overvoltage
T1	BC 807	Switch the battery voltage for open load in OFF diagnostic
CSense	100 pF	Sense signal filtering
Cvs	100 nF	Filtering of the voltage spikes on the battery line
COUT0	4.7 nF	Protection of the device during ESD and BCI

Ordering Information (Note 25)

Product	Marking	Reel Size (inches)	Tape Width (mm)	Quantity per Reel
ZXMS81045SPQ-13	ZXMS81045	13	12	2500

Note:
 25. For packaging details, please visit our website at <http://www.diodes.com/products/packages.html>.

Marking Information

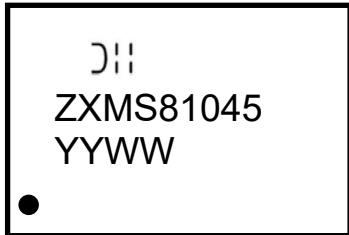

YY: Year
 WW: Week 01~52;
 52 represents 52 and 53 week

Package Outline Dimensions

Please see <http://www.diodes.com/package-outlines.html> for the latest version.

SO-8EP (Type E)

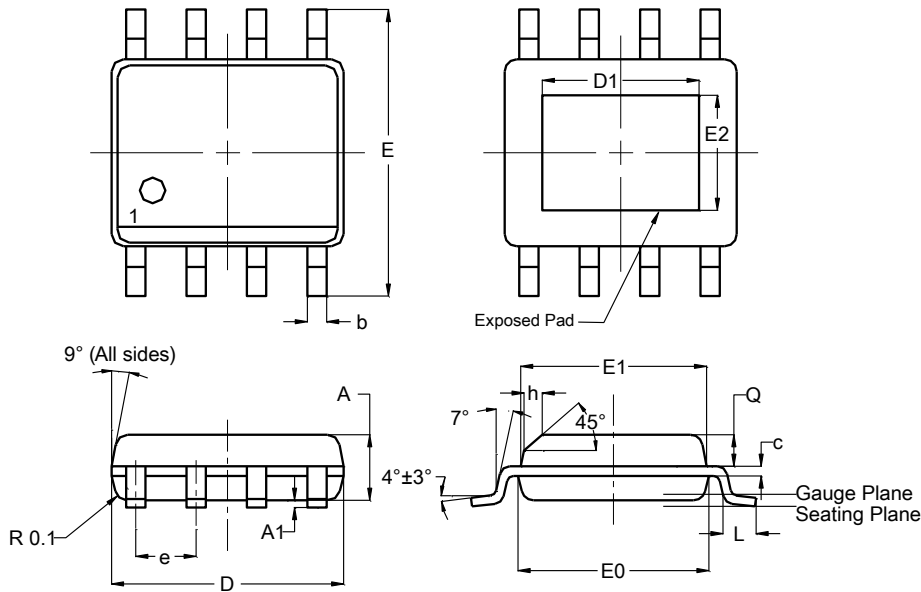

SO-8EP (Type E)			
Dim	Min	Max	Typ
A	1.40	1.50	1.45
A1	0.00	0.13	--
b	0.30	0.50	0.40
c	0.15	0.25	0.20
D	4.85	4.95	4.90
D1	2.65	3.75	3.70
E	5.90	6.10	6.00
E0	3.85	3.95	3.90
E1	3.80	3.90	3.85
E2	2.05	2.15	2.10
e	--	--	1.27
h	--	--	0.35
L	0.62	0.82	0.72
Q	0.60	0.70	0.65
All Dimensions in mm			

Suggested Pad Layout

Please see <http://www.diodes.com/package-outlines.html> for the latest version.

SO-8EP (Type E)

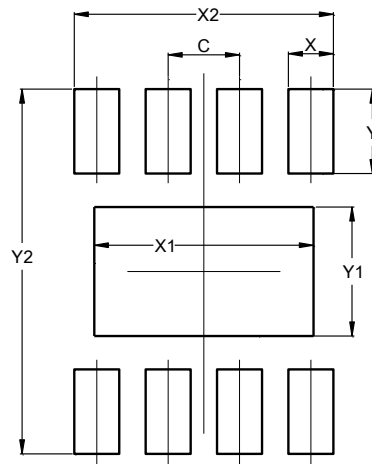

Dimensions	Value (in mm)
C	1.270
X	0.802
X1	3.900
X2	4.612
Y	1.505
Y1	2.300
Y2	6.500

IMPORTANT NOTICE

1. DIODES INCORPORATED (Diodes) AND ITS SUBSIDIARIES MAKE NO WARRANTY OF ANY KIND, EXPRESS OR IMPLIED, WITH REGARDS TO ANY INFORMATION CONTAINED IN THIS DOCUMENT, INCLUDING, BUT NOT LIMITED TO, THE IMPLIED WARRANTIES OF MERCHANTABILITY, FITNESS FOR A PARTICULAR PURPOSE OR NON-INFRINGEMENT OF THIRD PARTY INTELLECTUAL PROPERTY RIGHTS (AND THEIR EQUIVALENTS UNDER THE LAWS OF ANY JURISDICTION).
2. The Information contained herein is for informational purpose only and is provided only to illustrate the operation of Diodes' products described herein and application examples. Diodes does not assume any liability arising out of the application or use of this document or any product described herein. This document is intended for skilled and technically trained engineering customers and users who design with Diodes' products. Diodes' products may be used to facilitate safety-related applications; however, in all instances customers and users are responsible for (a) selecting the appropriate Diodes products for their applications, (b) evaluating the suitability of Diodes' products for their intended applications, (c) ensuring their applications, which incorporate Diodes' products, comply the applicable legal and regulatory requirements as well as safety and functional-safety related standards, and (d) ensuring they design with appropriate safeguards (including testing, validation, quality control techniques, redundancy, malfunction prevention, and appropriate treatment for aging degradation) to minimize the risks associated with their applications.
3. Diodes assumes no liability for any application-related information, support, assistance or feedback that may be provided by Diodes from time to time. Any customer or user of this document or products described herein will assume all risks and liabilities associated with such use, and will hold Diodes and all companies whose products are represented herein or on Diodes' websites, harmless against all damages and liabilities.
4. Products described herein may be covered by one or more United States, international or foreign patents and pending patent applications. Product names and markings noted herein may also be covered by one or more United States, international or foreign trademarks and trademark applications. Diodes does not convey any license under any of its intellectual property rights or the rights of any third parties (including third parties whose products and services may be described in this document or on Diodes' website) under this document.
5. Diodes' products are provided subject to Diodes' Standard Terms and Conditions of Sale (<https://www.diodes.com/about/company/terms-and-conditions/terms-and-conditions-of-sales/>) or other applicable terms. This document does not alter or expand the applicable warranties provided by Diodes. Diodes does not warrant or accept any liability whatsoever in respect of any products purchased through unauthorized sales channel.
6. Diodes' products and technology may not be used for or incorporated into any products or systems whose manufacture, use or sale is prohibited under any applicable laws and regulations. Should customers or users use Diodes' products in contravention of any applicable laws or regulations, or for any unintended or unauthorized application, customers and users will (a) be solely responsible for any damages, losses or penalties arising in connection therewith or as a result thereof, and (b) indemnify and hold Diodes and its representatives and agents harmless against any and all claims, damages, expenses, and attorney fees arising out of, directly or indirectly, any claim relating to any noncompliance with the applicable laws and regulations, as well as any unintended or unauthorized application.
7. While efforts have been made to ensure the information contained in this document is accurate, complete and current, it may contain technical inaccuracies, omissions and typographical errors. Diodes does not warrant that information contained in this document is error-free and Diodes is under no obligation to update or otherwise correct this information. Notwithstanding the foregoing, Diodes reserves the right to make modifications, enhancements, improvements, corrections or other changes without further notice to this document and any product described herein. This document is written in English but may be translated into multiple languages for reference. Only the English version of this document is the final and determinative format released by Diodes.
8. Any unauthorized copying, modification, distribution, transmission, display or other use of this document (or any portion hereof) is prohibited. Diodes assumes no responsibility for any losses incurred by the customers or users or any third parties arising from any such unauthorized use.
9. This Notice may be periodically updated with the most recent version available at <https://www.diodes.com/about/company/terms-and-conditions/important-notice>

DIODES is a trademark of Diodes Incorporated in the United States and other countries.
The Diodes logo is a registered trademark of Diodes Incorporated in the United States and other countries.
© 2022 Diodes Incorporated. All Rights Reserved.

www.diodes.com