

# LC717A10PJ

## Capacitance-Digital-Converter LSI for Electrostatic Capacitive Touch Sensors

### Overview

The LC717A10PJ is a high-performance and low-cost capacitance-digital-converter LSI for electrostatic capacitive touch sensor, especially focused on usability.

It has 16 channels capacitance-sensor input. This makes it ideal for use in the products that need many switches. Since the calibration function and the judgment of ON/OFF are automatically performed in LSI internal, it can make development time more short. A detection result (ON/OFF) for each input can be read out by the serial interface (I<sup>2</sup>C™ compatible bus or SPI).

Also, measurement value of each input can be read out as 8-bit digital data. Moreover, gain and other parameters can be adjusted using serial interface.

### Features

- Detection System: Differential Capacitance Detection (Mutual Capacitance Type)
- Input Capacitance Resolution: Can Detect Capacitance Changes in the Femto Farad Order
- Measurement Interval (16 Differential Inputs):
  - ◆ 30 ms (Typ) (at Initial Configuration)
  - ◆ 6 ms (Typ) (at Minimum Interval Configuration)
- External Components for Measurement: Not Required
- Current Consumption:
  - ◆ 570  $\mu$ A (Typ) ( $V_{DD} = 2.8$  V)
  - ◆ 1.3 mA (Typ) ( $V_{DD} = 5.5$  V)
- Supply Voltage: 2.6 V to 5.5 V
- Detection Operations: Switch
- Interface: I<sup>2</sup>C Compatible Bus or SPI Selectable



ON Semiconductor®

[www.onsemi.com](http://www.onsemi.com)

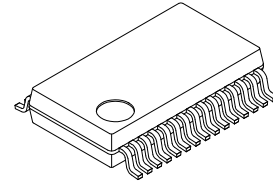

SSOP30 (225 mil)  
CASE 565AZ

### MARKING DIAGRAM

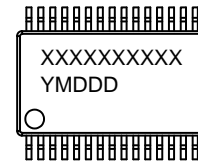

XXXXX = Specific Device Code  
Y = Year  
M = Month  
DDD = Additional Traceability Data

### ORDERING INFORMATION

See detailed ordering and shipping information on page 12 of this data sheet.

# LC717A10PJ

## Specifications

**Table 1. ABSOLUTE MAXIMUM RATINGS** ( $T_A = 25^\circ\text{C}$ ,  $V_{SS} = 0\text{ V}$ )

Parameter	Symbol	Ratings	Unit	Remarks
Supply Voltage	$V_{DD}$	-0.3 to +6.5	V	
Input Voltage	$V_{IN}$	-0.3 to $V_{DD} + 0.3$	V	(Note 1)
Output Voltage	$V_{OUT}$	-0.3 to $V_{DD} + 0.3$	V	(Note 2)
Power Dissipation	$P_{d\text{ max}}$	160	mW	$T_A = +105^\circ\text{C}$ , Mounted on a substrate (Note 3)
Peak Output Current	$I_{OP}$	$\pm 8$	mA	Per a Pin Duty Ratio 50% (Note 2)
Total Output Current	$I_{OA}$	$\pm 40$	mA	LSI Outputs Total Value Duty Ratio 25% (Note 2)

Stresses exceeding those listed in the Maximum Ratings table may damage the device. If any of these limits are exceeded, device functionality should not be assumed, damage may occur and reliability may be affected.

1. Apply to  $C_{in0}$  to 15,  $C_{ref}$ ,  $C_{refAdd}$ ,  $nRST$ ,  $SCL$ ,  $SDA$ ,  $SA0$ ,  $SA1$ ,  $SCK$ ,  $SI$ ,  $nCS$ .
2. Apply to  $C_{drv}$ ,  $SDA$ ,  $SO$ ,  $INTOUT$ .
3. Single-layer glass epoxy board (76.1 × 114.3 × 1.6t mm).

**Table 2. RECOMMENDED OPERATING CONDITIONS**

Parameter	Symbol	Conditions	Min	Typ	Max	Unit	Remarks
Operating Supply Voltage	$V_{DD}$		2.6	-	5.5	V	
Supply Ripple + Noise	$V_{PP}$		-	-	$\pm 40$	mV	(Note 4)
Operating Temperature	$T_{opr}$		-40	25	105	$^\circ\text{C}$	

Functional operation above the stresses listed in the Recommended Operating Ranges is not implied. Extended exposure to stresses beyond the Recommended Operating Ranges limits may affect device reliability.

4. Inserting a high-valued capacitor and a low-valued capacitor in parallel between  $V_{DD}$  and  $V_{SS}$  is recommended. In this case, the small-valued capacitor should be at least 0.1  $\mu\text{F}$ , and is mounted near the LSI.

**Table 3. ELECTRICAL CHARACTERISTICS**

( $V_{SS} = 0\text{ V}$ ,  $V_{DD} = 2.6$  to  $5.5\text{ V}$ ,  $T_A = -40$  to  $+105^\circ\text{C}$ , Unless otherwise specified, the  $C_{drv}$  drive frequency is  $f_{CDRV} = 143\text{ kHz}$ , and the Long Interval Time is  $T_{IVAL} = 101\text{ ms}$ . Not tested at low temperature before shipment.)

Parameter	Symbol	Conditions	Min	Typ	Max	Unit	Remarks
Capacitance Detection Resolution	N		-	-	8	bit	
Output Noise RMS	$N_{RMS}$	Minimum gain setting	-	-	$\pm 1.0$	LSB	(Notes 5, 7)
Input Offset Capacitance Adjustment Range	$Coff_{RANGE}$		-	$\pm 8.0$	-	pF	(Notes 5, 7)
Input Offset Capacitance Adjustment Resolution	$Coff_{RESO}$		-	8	-	bit	
$C_{in}$ Offset Drift	$C_{inDRIFT}$	Minimum gain setting	-	-	$\pm 8$	LSB	(Note 5)
$C_{in}$ Detection Sensitivity	$C_{inSENSE}$	Minimum gain setting	0.052	-	0.108	LSB/ff	(Note 6)
$C_{in}$ Pin Leak Current	$I_{Cin}$	$C_{in} = Hi-Z$	-	$\pm 25$	$\pm 500$	nA	
$C_{in}$ Allowable Parasitic Input Capacitance	$C_{inSUB}$	$C_{in}$ against $V_{SS}$	-	-	30	pF	(Notes 5, 7)
$C_{drv}$ Drive Frequency	$f_{CDRV}$		100	143	186	kHz	
		$V_{DD} = 5\text{ V} \pm 3\%$ , 54.8 kHz setting	50.4	59.45	68.5	kHz	(Note 5)
$nRST$ Minimum Pulse Width	$t_{NRST}$		1	-	-	$\mu\text{s}$	
Power-on Reset Time	$t_{POR}$		-	-	20	ms	
Power-on Reset Operation Condition: Hold Time	$t_{POROP}$		10	-	-	ms	(Note 5)

# LC717A10PJ

**Table 3. ELECTRICAL CHARACTERISTICS** (continued)

( $V_{SS} = 0\text{ V}$ ,  $V_{DD} = 2.6\text{ to }5.5\text{ V}$ ,  $T_A = -40\text{ to }+105^\circ\text{C}$ , Unless otherwise specified, the Cdrv drive frequency is  $f_{CDRV} = 143\text{ kHz}$ , and the Long Interval Time is  $T_{IVAL} = 101\text{ ms}$ . Not tested at low temperature before shipment.)

Parameter	Symbol	Conditions	Min	Typ	Max	Unit	Remarks
Power-on Reset Operation Condition: Input Voltage	$V_{POROP}$		–	–	0.1	V	(Note 5)
Power-on Reset Operation Condition: Power Supply Rise Rate	$t_{VDD}$	0 V to $V_{DD}$	1	–	–	V/ms	(Note 5)
Long Interval Time	$T_{IVAL}$		40	101	162	ms	
Pin Input Voltage	$V_{IH}$	High input	$0.8 V_{DD}$	–	–	V	(Note 8)
	$V_{IL}$	Low input	–	–	$0.2 V_{DD}$		
Pin Output Voltage	$V_{OH}$	High output ( $I_{OH} = +3\text{ mA}$ )	$0.8 V_{DD}$	–	–	V	(Note 9)
	$V_{OL}$	Low output ( $I_{OL} = -3\text{ mA}$ )	–	–	$0.2 V_{DD}$		
	$V_{OH}$	$V_{DD} = 5\text{ V} \pm 3\%$ , High output ( $I_{OH} = +3\text{ mA}$ )	$0.96 V_{DD}$	–	–	V	(Notes 5, 9)
	$V_{OL}$	$V_{DD} = 5\text{ V} \pm 3\%$ , Low output ( $I_{OL} = -3\text{ mA}$ )	–	–	$0.02 V_{DD}$		
SDA Pin Output Voltage	$V_{OL}^{I^2C}$	SDA Low output ( $I_{OL} = -3\text{ mA}$ )	–	–	0.4	V	
Pin Leak Current	$I_{LEAK}$		–	–	$\pm 1$	$\mu\text{A}$	(Note 10)
Current Consumption	$I_{DD}$	When initial setting and non-touch $V_{DD} = 2.8\text{ V}$	–	570	980	$\mu\text{A}$	(Note 5)
		When initial setting and non-touch $V_{DD} = 5.5\text{ V}$	–	1.3	2.2	mA	
		Short interval mode (short interval time is set to 5 ms) $V_{DD} = 5.5\text{ V}$	–	4.2	6.5	mA	
Current Consumption	$I_{STBY}$	During Sleep process	–	0.1	70	$\mu\text{A}$	

Product parametric performance is indicated in the Electrical Characteristics for the listed test conditions, unless otherwise noted. Product performance may not be indicated by the Electrical Characteristics if operated under different conditions.

5. Design-guaranteed values (not tested before shipment).
6. Measurements conducted using the test mode in the LSI.
7.  $T_A = +25^\circ\text{C}$ .
8. Apply to nRST, SCL, SDA, SA0, SA1, SCK, SI, nCS.
9. Apply to Cdrv, SO, INTOUT.
10. Apply to nRST, SCL, SDA, SA0, SA1, SCK, SI, nCS.

# LC717A10PJ

**Table 4. I<sup>2</sup>C COMPATIBLE BUS TIMING CHARACTERISTICS**

(V<sub>SS</sub> = 0 V, V<sub>DD</sub> = 2.6 to 5.5 V, T<sub>A</sub> = -40 to +105°C, Not tested at low temperature before shipment.)

Parameter	Symbol	Pin Name	Conditions	Min	Typ	Max	Unit	Remarks
SCL Clock Frequency	f <sub>SCL</sub>	SCL		–	–	400	kHz	
START Condition Hold Time	t <sub>HD;STA</sub>	SCL, SDA		0.6	–	–	μs	
SCL Clock Low Period	t <sub>LOW</sub>	SCL		1.3	–	–	μs	
SCL Clock High Period	t <sub>HIGH</sub>	SCL		0.6	–	–	μs	
Repeated START Condition Setup Time	t <sub>SU;STA</sub>	SCL, SDA		0.6	–	–	μs	(Note 11)
Data Hold Time	t <sub>HD;DAT</sub>	SCL, SDA		0	–	0.9	μs	
Data Setup Time	t <sub>SU;DAT</sub>	SCL, SDA		500	–	–	ns	
				100	–	–	ns	(Note 11)
SDA, SCL Rise/Fall Time	t <sub>r</sub> / t <sub>f</sub>	SCL, SDA		–	–	300	ns	(Note 11)
STOP Condition Setup Time	t <sub>SU;STO</sub>	SCL, SDA		0.6	–	–	μs	
STOP-to-START Bus Release Time	t <sub>BUF</sub>	SCL, SDA		2.5	–	–	μs	
				1.3	–	–	μs	(Note 11)

Product parametric performance is indicated in the Electrical Characteristics for the listed test conditions, unless otherwise noted. Product performance may not be indicated by the Electrical Characteristics if operated under different conditions.

11. Design-guaranteed values (not tested before shipment).

**Table 5. SPI BUS TIMING CHARACTERISTICS**

(V<sub>SS</sub> = 0 V, V<sub>DD</sub> = 2.6 to 5.5 V, T<sub>A</sub> = -40 to +105°C, Not tested at low temperature before shipment.)

Parameter	Symbol	Pin Name	Conditions	Min	Typ	Max	Unit	Remarks
SCK Clock Frequency	f <sub>SCK</sub>	SCK		–	–	5	MHz	
SCK Clock Low Time	t <sub>LOW</sub>	SCK		100	–	–	ns	
				90	–	–	ns	(Note 12)
SCK Clock High Time	t <sub>HIGH</sub>	SCK		100	–	–	ns	
				90	–	–	ns	(Note 12)
Input Signal Rise/Fall Time	t <sub>r</sub> / t <sub>f</sub>	nCS, SCK, SI		–	–	300	ns	(Note 12)
nCS Setup Time	t <sub>SU;nCS</sub>	nCS, SCK		200	–	–	ns	
				90	–	–	ns	(Note 12)
SCK Clock Setup Time	t <sub>SU;SCK</sub>	nCS, SCK		100	–	–	ns	
				90	–	–	ns	(Note 12)
Data Setup Time	t <sub>SU;SI</sub>	SCK, SI		100	–	–	ns	
				20	–	–	ns	(Note 12)
Data Hold Time	t <sub>HD;SI</sub>	SCK, SI		100	–	–	ns	
				30	–	–	ns	(Note 12)
nCS Hold Time	t <sub>HD;nCS</sub>	nCS, SCK		200	–	–	ns	
				90	–	–	ns	(Note 12)
SCK Clock Hold Time	t <sub>HD;SCK</sub>	nCS, SCK		700	–	–	ns	
				90	–	–	ns	(Note 12)
nCS Standby Pulse Width	t <sub>CPH</sub>	nCS		300	–	–	ns	
				90	–	–	ns	(Note 12)
Output High Impedance Time from nCS	t <sub>CHZ</sub>	nCS, SO		–	–	80	ns	(Note 12)

# LC717A10PJ

**Table 5. SPI BUS TIMING CHARACTERISTICS** (continued)

( $V_{SS} = 0\text{ V}$ ,  $V_{DD} = 2.6\text{ to }5.5\text{ V}$ ,  $T_A = -40\text{ to }+105^\circ\text{C}$ , Not tested at low temperature before shipment.)

Parameter	Symbol	Pin Name	Conditions	Min	Typ	Max	Unit	Remarks
Output Data Determination Time	$t_v$	SCK, SO		–	–	100	ns	
				–	–	80	ns	(Note 12)
Output Data Hold Time	$t_{HD;SO}$	SCK, SO		100	–	–	ns	
				0	–	–	ns	(Note 12)
Output Low Impedance Time from SCK Clock	$t_{CLZ}$	SCK, SO		100	–	–	ns	
				0	–	–	ns	(Note 12)

Product parametric performance is indicated in the Electrical Characteristics for the listed test conditions, unless otherwise noted. Product performance may not be indicated by the Electrical Characteristics if operated under different conditions.

12. Design-guaranteed values (not tested before shipment).

## Dynamic Offset Calibration Function to Correct $C_{IN}$ Offset Drift

When measurement data at a certain channel are consecutively within the execution range of dynamic offset calibration (4 to touch threshold, or  $-128$  to  $-4$ ) for the period of time corresponding to a value, dynamic offset calibration is performed and the reference value at the channel is gradually corrected to 0.

The figure below shows the operation when the measured value began to drift in the positive direction from the central value gradually.

The examples of settings to 8 times the dynamic offset calibration carried count.

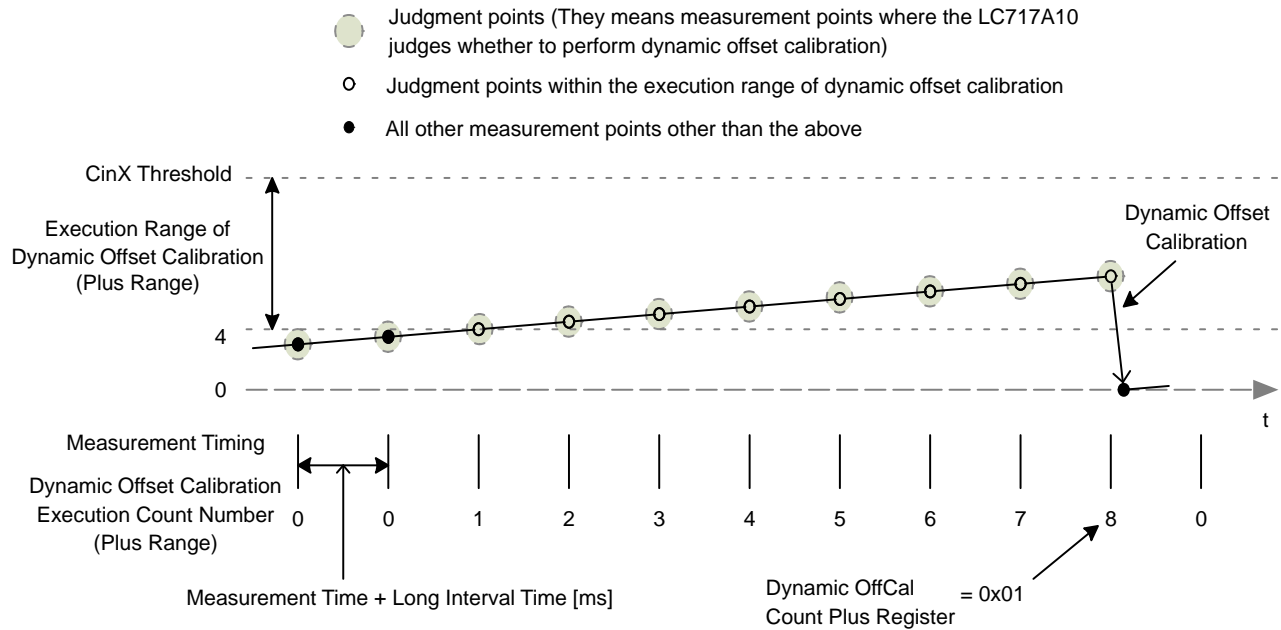

\*When measurement data is out of the execution range of dynamic calibration, the plus side's dynamic offset calibration execution count number is immediately reset to "0".

**Figure 1.**

# LC717A10PJ

## Power-On Reset (POR)

When power is turned on, power-on reset is enabled inside the LSI and its state is released after a certain power-on reset time,  $t_{POR}$ . Power-on reset operation condition: Power supply rise rate  $t_{VDD}$  must be at least 1 V/ms.

Since INTOUT pin changes from “High” to “Low” at the same time as the released of power-on reset, it is possible to verify the timing of release of power-on reset externally.

During power-on reset,  $C_{in}$ ,  $C_{ref}$  and  $C_{refAdd}$  are unknown.

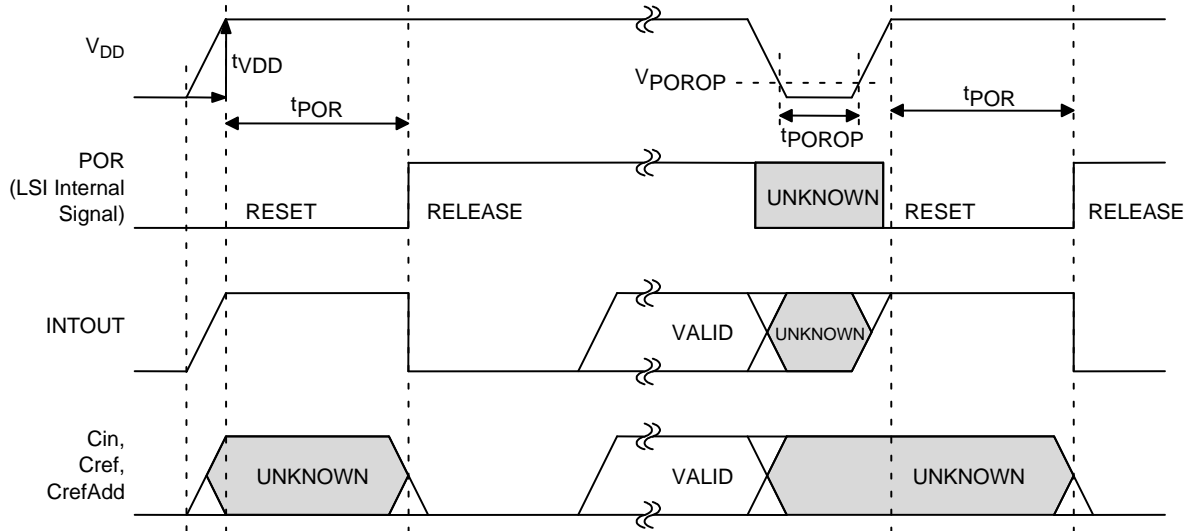

Figure 2.

## I<sup>2</sup>C Compatible Bus Data Timing

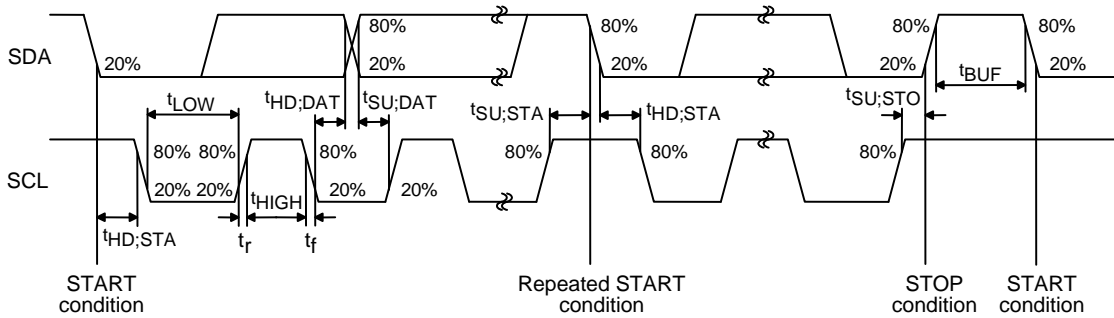

Figure 3.

## I<sup>2</sup>C Compatible Bus Communication Formats

- Write format (data can be written into sequentially incremented addresses)



Figure 4.

- Read format (data can be read from sequentially incremented addresses)



Figure 5.

# LC717A10PJ

## I<sup>2</sup>C Compatible Bus Slave Address

Selection of four kinds of addresses is possible through the SA0 and SA1 terminals.

Table 6.

SA1 Pin Input	SA0 Pin Input	7-bit Slave Address	Binary Notation	8-bit Slave Address
Low	Low	0x16	00101100b (Write)	0x2C
			00101101b (Read)	0x2D
Low	High	0x17	00101110b (Write)	0x2E
			00101111b (Read)	0x2F
High	Low	0x18	00110000b (Write)	0x30
			00110001b (Read)	0x31
High	High	0x19	00110010b (Write)	0x32
			00110011b (Read)	0x33

## SPI Data Timing (SPI Mode 0 / Mode 3)

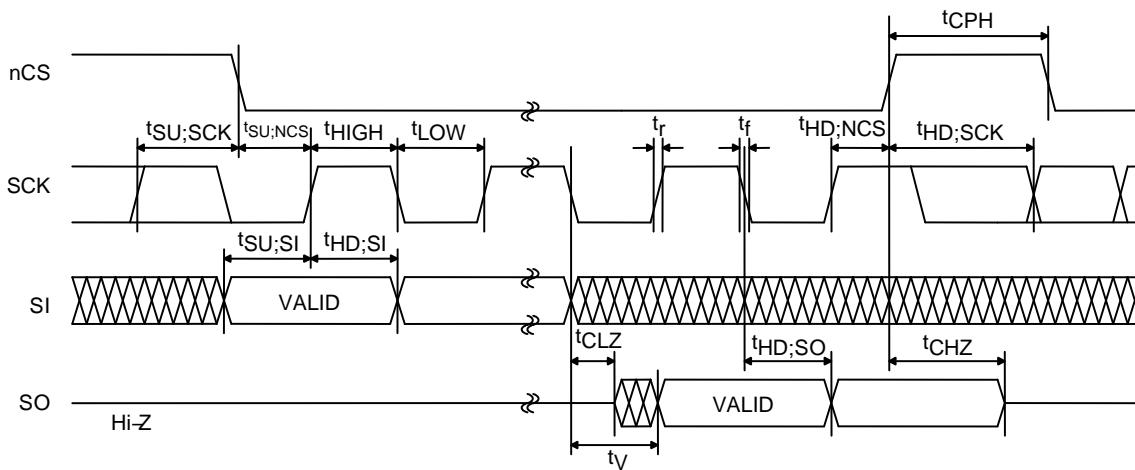

Figure 6.

## SPI Communication Formats (Example of Mode 0)

- Write format (data can be written into sequentially incremented addresses while preserving nCS = L)

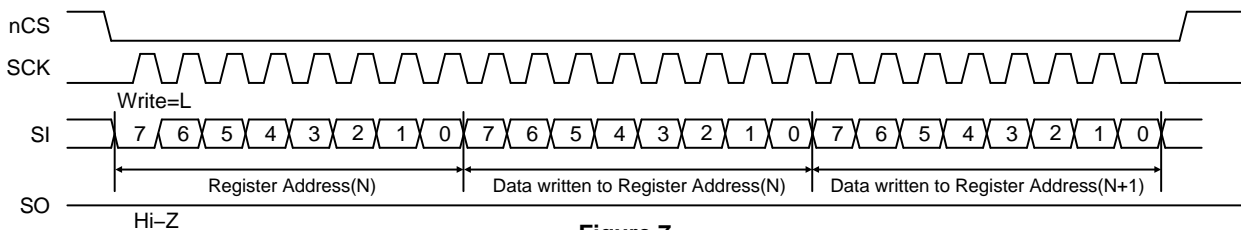

Figure 7.

- Read format (data can be read from sequentially incremented addresses while preserving nCS = L)

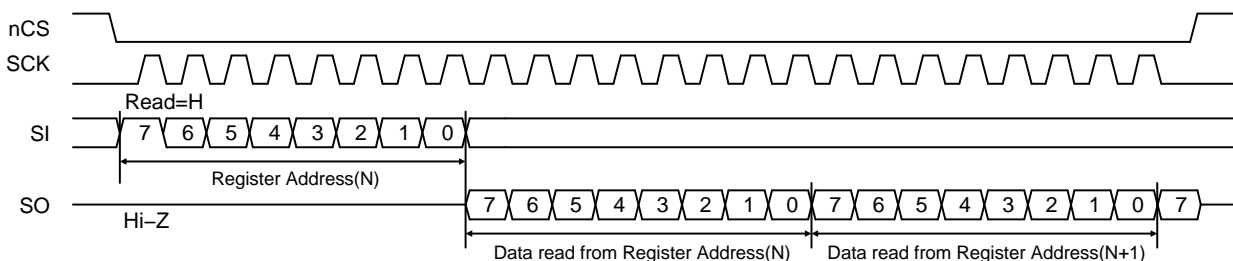
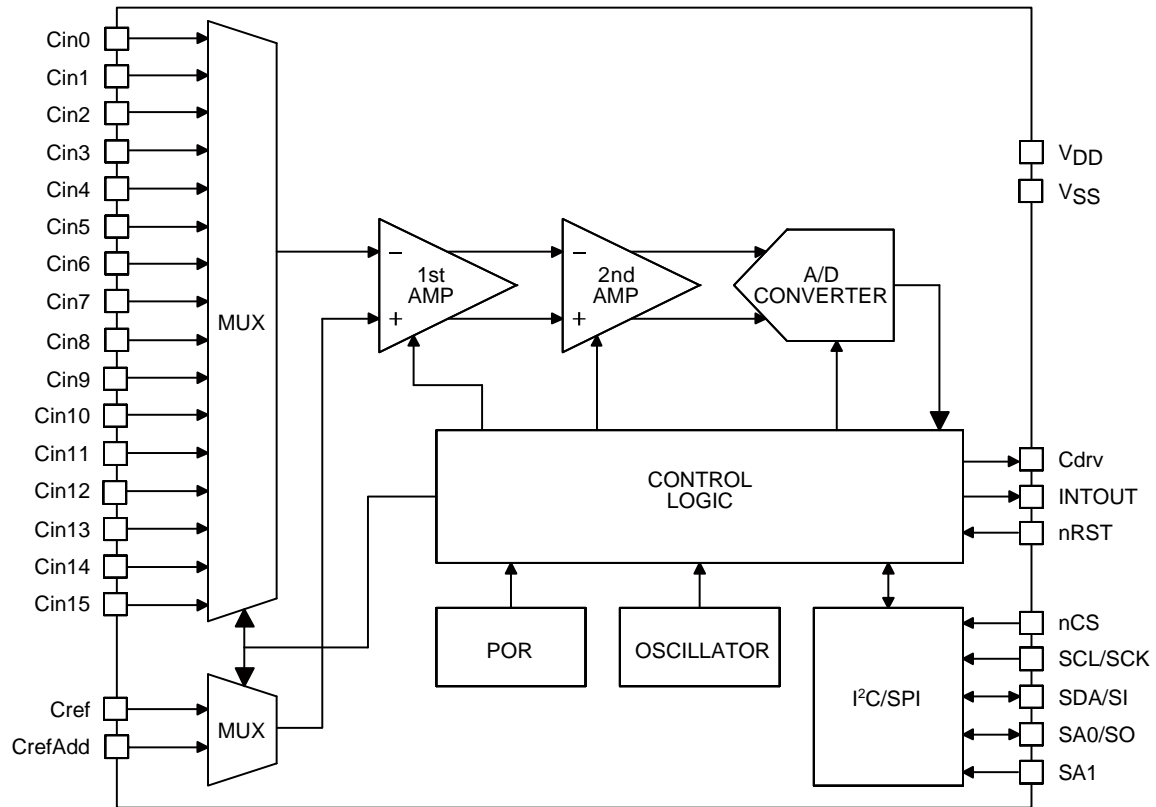

Figure 8.

# LC717A10PJ

## Block Diagram



**Figure 9. Simplified Block Diagram**

LC717A10PJ is capacitance-digital-converter LSI capable of detecting changes in capacitance in the order of femto Farads. It consists of an oscillation circuit that generates the system clock, a power-on reset circuit that resets the system when the power is turned on, a multiplexer that selects the input channels, a two-stage amplifier that

detects the changes in the capacitance and outputs analog-amplitude values, a A/D converter that converts the analog-amplitude values into digital data, an I<sup>2</sup>C compatible bus or a SPI that enables serial communication with external devices and a control logic that controls the entire chip.



# LC717A10PJ

## Pin Assignment

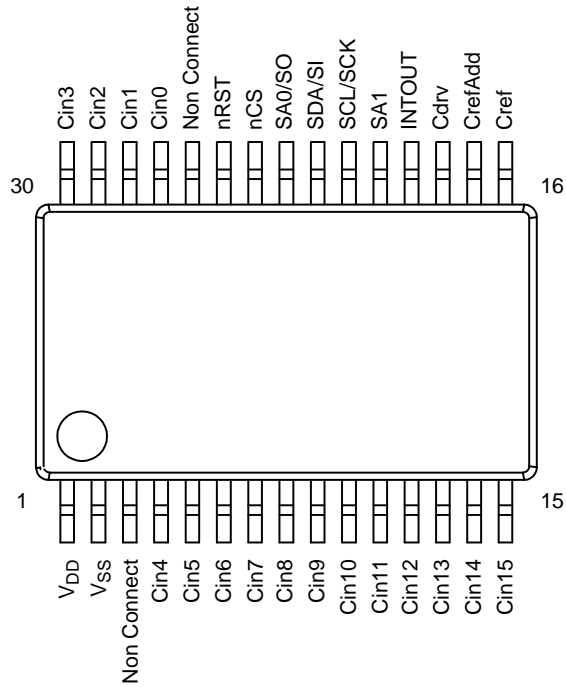

Figure 10. Pin Assignment (Top View)

Table 7. PIN ASSIGNMENT

Pin No.	Pin Name	Pin No.	Pin Name
1	V <sub>DD</sub>	16	Cref
2	V <sub>SS</sub>	17	CrefAdd
3	Non Connect (Note 13)	18	Cdrv
4	Cin4	19	INTOUT
5	Cin5	20	SA1
6	Cin6	21	SCL/SCK
7	Cin7	22	SDA/SI
8	Cin8	23	SA0/SO
9	Cin9	24	nCS
10	Cin10	25	nRST
11	Cin11	26	Non Connect (Note 13)
12	Cin12	27	Cin0
13	Cin13	28	Cin1
14	Cin14	29	Cin2
15	Cin15	30	Cin3

13. Connect to GND when mounted.

# LC717A10PJ

**Table 8. PIN FUNCTION**

Pin Name	I/O	Pin Functions	Pin Type
Cin0	I/O	Capacitance sensor input	
Cin1	I/O	Capacitance sensor input	
Cin2	I/O	Capacitance sensor input	
Cin3	I/O	Capacitance sensor input	
Cin4	I/O	Capacitance sensor input	
Cin5	I/O	Capacitance sensor input	
Cin6	I/O	Capacitance sensor input	
Cin7	I/O	Capacitance sensor input	
Cin8	I/O	Capacitance sensor input	
Cin9	I/O	Capacitance sensor input	
Cin10	I/O	Capacitance sensor input	
Cin11	I/O	Capacitance sensor input	
Cin12	I/O	Capacitance sensor input	
Cin13	I/O	Capacitance sensor input	
Cin14	I/O	Capacitance sensor input	
Cin15	I/O	Capacitance sensor input	
Cref	I/O	Reference capacitance input	
CrefAdd	I/O	Reference capacitance input for addition	
Cdrv	O	Output for capacitance sensors drive	
INTOUT	O	Interrupt output	
SCL/SCK	I	Clock input (I <sup>2</sup> C) / Clock input (SPI)	
nCS	I	Interface selection / Chip select inverting input (SPI)	
nRST	I	External reset signal inverting input	
SA1	I	Slave address selection (I <sup>2</sup> C)	
SDA/SI	I/O	Data input and output (I <sup>2</sup> C) / Data input (SPI)	

Table 8. PIN FUNCTION (continued)

Pin Name	I/O	Pin Functions	Pin Type
SA0/SO	I/O	Slave address selection (I <sup>2</sup> C) / Data output (SPI)	
V <sub>DD</sub>		Power supply (2.6 V to 5.5 V) (Note 14)	
V <sub>SS</sub>		Ground (Earth) (Notes 14, 15)	

14. Inserting a high-valued capacitor and a low-valued capacitor in parallel between V<sub>DD</sub> and V<sub>SS</sub> is recommended. In this case, the small-valued capacitor should be at least 0.1 μF, and is mounted near the LSI.

15. When V<sub>SS</sub> terminal is not grounded in battery-powered mobile equipment, detection sensitivity may be degraded.

**Details of Pin Functions**

*Cin0 to Cin15*

These are the capacitance-sensor-input pins. These pins are used by connecting them to the touch switch pattern. Cin and the Cdrv wire patterns should be close to each other. By doing so, Cdrv and Cin patterns are capacitively coupled. Therefore, LSI can detect capacitance change near each pattern as 8-bit digital data.

However, if the shape of each pattern or the capacitively coupled value of Cdrv is not appropriate, it may not be able to detect the capacitance change correctly.

In this LSI, there is a two-stage amplifier that detects the changes in the capacitance and outputs analog-amplitude values. Cin0 to Cin15 are connected to the inverting input of the 1<sup>st</sup> amplifier.

During measurement process, channels other than the one being measured are all in “Low” condition.

Leave the unused terminals open.

*Cref, CrefAdd*

These are the reference-capacitance-input pins. These are used by connecting to the wire pattern like Cin pins or are used by connecting any capacitance between this pin and Cdrv pin.

In this LSI, there is a two-stage amplifier that detects the changes in the capacitance and outputs analog-amplitude values. Cref is connected to the non-inverting input of the 1<sup>st</sup> amplifier.

Due to the parasitic capacitance generated in the wire connections of Cin pins and their patterns, as well as the one generated between the wire patterns of Cin and Cdrv pins, Cref may not detect capacitance change of each Cin pin accurately. In this case, connect an appropriate capacitance between Cref and Cdrv to detect capacitance change accurately.

However, if the difference between the parasitic capacitance of each Cin pin is extremely large, it may not detect capacitance change in each Cin pin correctly.

CrefAdd can be used as additional terminal for Cref. Leave the CrefAdd open if not in used.

*Cdrv*

It is the output pin for capacitance sensors drive. It outputs the pulse voltage which is needed to detect capacitance at Cin0 to Cin15.

Cdrv and Cin wire patterns should be close to each other so that they are capacitively coupled.

*INTOUT*

It is the interrupt-output pin. It is used by connecting to a main microcomputer if necessary, and use as interrupt signal. (High Active).

Leave the terminal open if not in used.

*SCL/SCK*

Clock input (I<sup>2</sup>C)/Clock input (SPI). It is the clock input pin of the I<sup>2</sup>C compatible bus or the SPI depending on the mode of operation.

*nCS*

Interface selection/Chip-select-inverting input (SPI). Selection of I<sup>2</sup>C compatible bus mode or SPI mode is through this terminal. After initialization, the LSI is automatically in I<sup>2</sup>C compatible bus mode. To continually use I<sup>2</sup>C compatible bus mode, fix nCS pin to “High”. To switch to SPI mode after LSI initialization, change the nCS input “High” → “Low”. The nCS pin is used as the chip-select-inverting input pin of SPI, and SPI mode is kept until LSI is again initialized.

## LC717A10PJ

### *nRST*

It is the external-reset-signal-inverting-input pin. When nRST pin is “Low”, LSI is in the reset state.

Each pin (Cin0 to 15, Cref, CrefAdd) is “Hi-Z” during reset state.

### *SDA/SI*

Data input and output (I<sup>2</sup>C)/Data input (SPI). It is the data input and output pin of the I<sup>2</sup>C compatible bus or the data input pin of the SPI depending on the mode of operation.

### *SA0/SO*

Slave address selection (I<sup>2</sup>C)/Data output (SPI). It is the slave address selection pin of the I<sup>2</sup>C compatible bus or the data output pin of the SPI depending on the mode of operation.

### *SA1*

Slave address selection (I<sup>2</sup>C). It is the slave address selection pin of the I<sup>2</sup>C compatible bus.

When SPI mode, connect to the SA1 pin to GND.

**Table 9. ORDERING INFORMATION**

Device	Package	Shipping (Qty / Packing) <sup>†</sup>
LC717A10PJ-AH	SSOP30 (225 mil) (Pb-Free / Halogen Free)	1000 / Tape & Reel

<sup>†</sup>For information on tape and reel specifications, including part orientation and tape sizes, please refer to our Tape and Reel Packaging Specifications Brochure, [BRD8011/D](#).

# MECHANICAL CASE OUTLINE

## PACKAGE DIMENSIONS

ON Semiconductor®

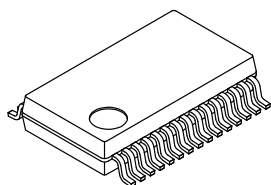

**SSOP30 (225 mil)**  
**CASE 565AZ**  
**ISSUE A**

DATE 25 OCT 2013

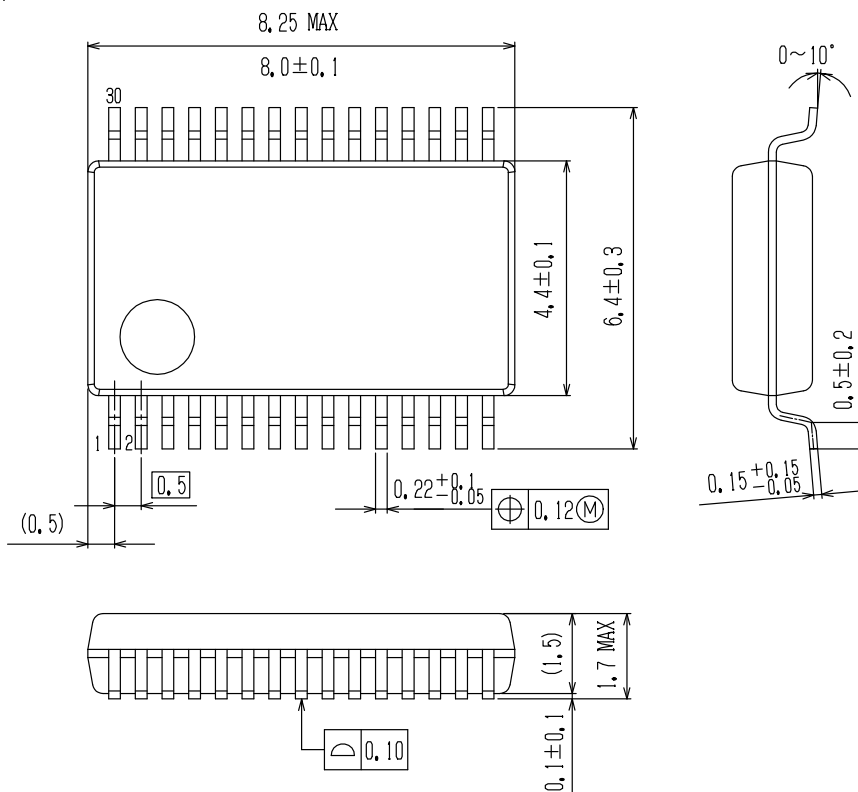

### SOLDERING FOOTPRINT\*

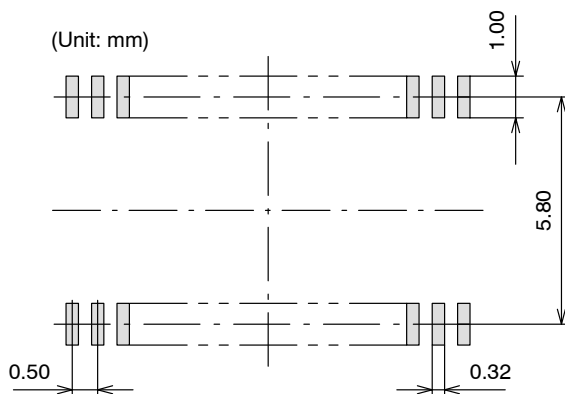

NOTE: The measurements are not to guarantee but for reference only.

\*For additional information on our Pb-Free strategy and soldering details, please download the ON Semiconductor Soldering and Mounting Techniques Reference Manual, SOLDERRM/D.

### GENERIC MARKING DIAGRAM\*

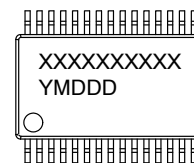

XXXXX = Specific Device Code  
 Y = Year  
 M = Month  
 DDD = Additional Traceability Data

\*This information is generic. Please refer to device data sheet for actual part marking. Pb-Free indicator, "G" or microdot "•", may or may not be present.

<b>DOCUMENT NUMBER:</b>	<b>98AON80824E</b>	Electronic versions are uncontrolled except when accessed directly from the Document Repository. Printed versions are uncontrolled except when stamped "CONTROLLED COPY" in red.
<b>DESCRIPTION:</b>	<b>SSOP30 (225 MIL)</b>	<b>PAGE 1 OF 1</b>

ON Semiconductor and are trademarks of Semiconductor Components Industries, LLC dba ON Semiconductor or its subsidiaries in the United States and/or other countries. ON Semiconductor reserves the right to make changes without further notice to any products herein. ON Semiconductor makes no warranty, representation or guarantee regarding the suitability of its products for any particular purpose, nor does ON Semiconductor assume any liability arising out of the application or use of any product or circuit, and specifically disclaims any and all liability, including without limitation special, consequential or incidental damages. ON Semiconductor does not convey any license under its patent rights nor the rights of others.

ON Semiconductor and  are trademarks of Semiconductor Components Industries, LLC dba ON Semiconductor or its subsidiaries in the United States and/or other countries. ON Semiconductor owns the rights to a number of patents, trademarks, copyrights, trade secrets, and other intellectual property. A listing of ON Semiconductor's product/patent coverage may be accessed at [www.onsemi.com/site/pdf/Patent-Marking.pdf](http://www.onsemi.com/site/pdf/Patent-Marking.pdf). ON Semiconductor reserves the right to make changes without further notice to any products herein. ON Semiconductor makes no warranty, representation or guarantee regarding the suitability of its products for any particular purpose, nor does ON Semiconductor assume any liability arising out of the application or use of any product or circuit, and specifically disclaims any and all liability, including without limitation special, consequential or incidental damages. Buyer is responsible for its products and applications using ON Semiconductor products, including compliance with all laws, regulations and safety requirements or standards, regardless of any support or applications information provided by ON Semiconductor. "Typical" parameters which may be provided in ON Semiconductor data sheets and/or specifications can and do vary in different applications and actual performance may vary over time. All operating parameters, including "Typicals" must be validated for each customer application by customer's technical experts. ON Semiconductor does not convey any license under its patent rights nor the rights of others. ON Semiconductor products are not designed, intended, or authorized for use as a critical component in life support systems or any FDA Class 3 medical devices or medical devices with a same or similar classification in a foreign jurisdiction or any devices intended for implantation in the human body. Should Buyer purchase or use ON Semiconductor products for any such unintended or unauthorized application, Buyer shall indemnify and hold ON Semiconductor and its officers, employees, subsidiaries, affiliates, and distributors harmless against all claims, costs, damages, and expenses, and reasonable attorney fees arising out of, directly or indirectly, any claim of personal injury or death associated with such unintended or unauthorized use, even if such claim alleges that ON Semiconductor was negligent regarding the design or manufacture of the part. ON Semiconductor is an Equal Opportunity/Affirmative Action Employer. This literature is subject to all applicable copyright laws and is not for resale in any manner.

## PUBLICATION ORDERING INFORMATION

### LITERATURE FULFILLMENT:

Email Requests to: [orderlit@onsemi.com](mailto:orderlit@onsemi.com)

ON Semiconductor Website: [www.onsemi.com](http://www.onsemi.com)

### TECHNICAL SUPPORT

North American Technical Support:  
Voice Mail: 1 800-282-9855 Toll Free USA/Canada  
Phone: 011 421 33 790 2910

Europe, Middle East and Africa Technical Support:

Phone: 00421 33 790 2910

For additional information, please contact your local Sales Representative

