

# 2N5060 Series

## Sensitive Gate Silicon Controlled Rectifiers Reverse Blocking Thyristors

Annular PNP devices designed for high volume consumer applications such as relay and lamp drivers, small motor controls, gate drivers for larger thyristors, and sensing and detection circuits. Supplied in an inexpensive plastic TO-92/TO-226AA package which is readily adaptable for use in automatic insertion equipment.

### Features

- Sensitive Gate Trigger Current – 200  $\mu$ A Maximum
- Low Reverse and Forward Blocking Current – 50  $\mu$ A Maximum,  $T_C = 110^\circ\text{C}$
- Low Holding Current – 5 mA Maximum
- Passivated Surface for Reliability and Uniformity
- These are Pb-Free Devices

### MAXIMUM RATINGS ( $T_J = 25^\circ\text{C}$ unless otherwise noted)

Rating	Symbol	Value	Unit
Peak Repetitive Off-State Voltage (Note 1) ( $T_J = -40$ to $110^\circ\text{C}$ , Sine Wave, 50 to 60 Hz, $R_{GK} = 1 \text{ k}\Omega$ )	$V_{DRM}$ , $V_{RRM}$	30 60 100 200	V
On-State Current RMS (180° Conduction Angles; $T_C = 80^\circ\text{C}$ )	$I_{T(RMS)}$	0.8	A
*Average On-State Current (180° Conduction Angles)	$I_{T(AV)}$	0.51 0.255	A
		( $T_C = 67^\circ\text{C}$ ) ( $T_C = 102^\circ\text{C}$ )	
*Peak Non-repetitive Surge Current, $T_A = 25^\circ\text{C}$ (1/2 cycle, Sine Wave, 60 Hz)	$I_{TSM}$	10	A
Circuit Fusing Considerations ( $t = 8.3 \text{ ms}$ )	$I^2t$	0.4	$\text{A}^2\text{s}$
*Average On-State Current (180° Conduction Angles)	$I_{T(AV)}$	0.51 0.255	A
		( $T_C = 67^\circ\text{C}$ ) ( $T_C = 102^\circ\text{C}$ )	
*Forward Peak Gate Power (Pulse Width $\leq$ 1.0 $\mu\text{sec}$ ; $T_A = 25^\circ\text{C}$ )	$P_{GM}$	0.1	W
*Forward Average Gate Power ( $T_A = 25^\circ\text{C}$ , $t = 8.3 \text{ ms}$ )	$P_{G(AV)}$	0.01	W
*Forward Peak Gate Current (Pulse Width $\leq 1.0 \mu\text{sec}$ ; $T_A = 25^\circ\text{C}$ )	$I_{GM}$	1.0	A
*Reverse Peak Gate Voltage (Pulse Width $\leq 1.0 \mu\text{sec}$ ; $T_A = 25^\circ\text{C}$ )	$V_{RGM}$	5.0	V
*Operating Junction Temperature Range	$T_J$	-40 to +110	$^\circ\text{C}$
*Storage Temperature Range	$T_{stg}$	-40 to +150	$^\circ\text{C}$

Stresses exceeding Maximum Ratings may damage the device. Maximum Ratings are stress ratings only. Functional operation above the Recommended Operating Conditions is not implied. Extended exposure to stresses above the Recommended Operating Conditions may affect device reliability.

1.  $V_{DRM}$  and  $V_{RRM}$  for all types can be applied on a continuous basis. Ratings apply for zero or negative gate voltage; however, positive gate voltage shall not be applied concurrent with negative potential on the anode. Blocking voltages shall not be tested with a constant current source such that the voltage ratings of the devices are exceeded.

\*Indicates JEDEC Registered Data.



ON Semiconductor®

<http://onsemi.com>

**SILICON CONTROLLED  
RECTIFIERS**  
**0.8 A RMS, 30 – 200 V**

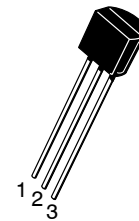
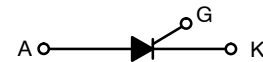

TO-92  
CASE 29  
STYLE 10

### MARKING DIAGRAM

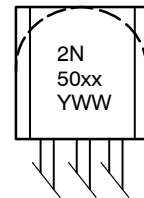

50xx Specific Device Code  
Y = Year  
WW = Work Week

### PIN ASSIGNMENT

Pin	Assignment
1	Cathode
2	Gate
3	Anode

### ORDERING INFORMATION

See detailed ordering and shipping information in the package dimensions section on page 6 of this data sheet.

## 2N5060 Series

### THERMAL CHARACTERISTICS

Characteristic	Symbol	Max	Unit
*Thermal Resistance, Junction-to-Case (Note 2)	$R_{\theta JC}$	75	$^{\circ}C/W$
Thermal Resistance, Junction-to-Ambient	$R_{\theta JA}$	200	$^{\circ}C/W$

2. This measurement is made with the case mounted "flat side down" on a heatsink and held in position by means of a metal clamp over the curved surface.

\*Indicates JEDEC Registered Data.

### ELECTRICAL CHARACTERISTICS ( $T_C = 25^{\circ}C$ unless otherwise noted)

Characteristic	Symbol	Min	Typ	Max	Unit
----------------	--------	-----	-----	-----	------

#### OFF CHARACTERISTICS

*Peak Repetitive Forward or Reverse Blocking Current (Note 3) ( $V_{AK} = \text{Rated } V_{DRM} \text{ or } V_{RRM}$ )	$I_{DRM}, I_{RRM}$	-	-	10	$\mu A$
$T_C = 25^{\circ}C$		-	-	50	$\mu A$
$T_C = 110^{\circ}C$		-	-		

#### ON CHARACTERISTICS

*Peak Forward On-State Voltage (Note 4) ( $I_{TM} = 1.2 \text{ A peak @ } T_A = 25^{\circ}C$ )	$V_{TM}$	-	-	1.7	V
Gate Trigger Current (Continuous DC) (Note 5) *( $V_{AK} = 7.0 \text{ Vdc}, R_L = 100 \Omega$ )	$I_{GT}$	-	-	200	$\mu A$
$T_C = 25^{\circ}C$		-	-	350	
$T_C = -40^{\circ}C$		-	-		
Gate Trigger Voltage (Continuous DC) (Note 5) *( $V_{AK} = 7.0 \text{ Vdc}, R_L = 100 \Omega$ )	$V_{GT}$	-	-	0.8	V
$T_C = 25^{\circ}C$		-	-	1.2	
$T_C = -40^{\circ}C$		-	-		
*Gate Non-Trigger Voltage ( $V_{AK} = \text{Rated } V_{DRM}, R_L = 100 \Omega, T_C = 110^{\circ}C$ )	$V_{GD}$	0.1	-	-	V
Holding Current (Note 3) *( $V_{AK} = 7.0 \text{ Vdc}, \text{ initiating current} = 20 \text{ mA}$ )	$I_H$	-	-	5.0	mA
$T_C = 25^{\circ}C$		-	-	10	
$T_C = -40^{\circ}C$		-	-		
Turn-On Time Delay Time Rise Time ( $I_{GT} = 1.0 \text{ mA}, V_D = \text{Rated } V_{DRM},$ Forward Current = 1.0 A, $di/dt = 6.0 \text{ A}/\mu s$ )	$t_d$ $t_r$	-	3.0 0.2	-	$\mu s$
Turn-Off Time (Forward Current = 1.0 A pulse, Pulse Width = 50 $\mu s$ , 0.1% Duty Cycle, $di/dt = 6.0 \text{ A}/\mu s$ , $dv/dt = 20 \text{ V}/\mu s, I_{GT} = 1 \text{ mA}$ )	$t_q$	-	10	-	$\mu s$
2N5060, 2N5061		-	30	-	
2N5062, 2N5064		-		-	

#### DYNAMIC CHARACTERISTICS

Critical Rate of Rise of Off-State Voltage (Rated $V_{DRM}$ , Exponential, $R_{GK} = 1 \text{ k}\Omega$ )	$dv/dt$	-	30	-	$V/\mu s$
--	---------	---	----	---	-----------

\*Indicates JEDEC Registered Data.

3.  $R_{GK} = 1000 \Omega$  is included in measurement.
4. Forward current applied for 1 ms maximum duration, duty cycle  $\leq 1\%$ .
5.  $R_{GK}$  current is not included in measurement.

# 2N5060 Series

## Voltage Current Characteristic of SCR

Symbol	Parameter
$V_{DRM}$	Peak Repetitive Off State Forward Voltage
$I_{DRM}$	Peak Forward Blocking Current
$V_{RRM}$	Peak Repetitive Off State Reverse Voltage
$I_{RRM}$	Peak Reverse Blocking Current
$V_{TM}$	Peak on State Voltage
$I_H$	Holding Current

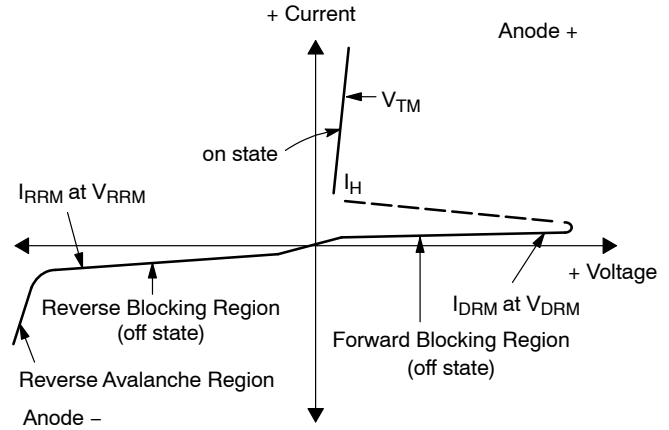

## CURRENT DERATING

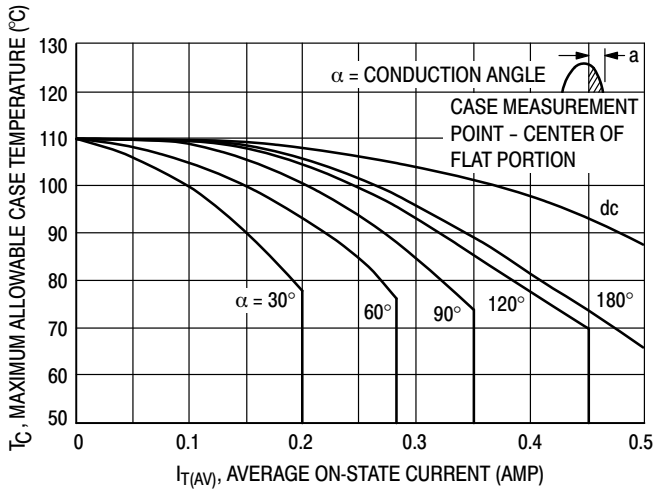

Figure 1. Maximum Case Temperature

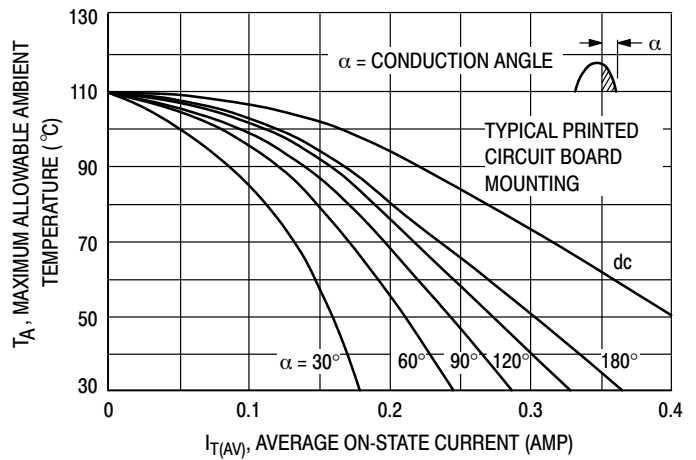

Figure 2. Maximum Ambient Temperature

# 2N5060 Series

## CURRENT DERATING

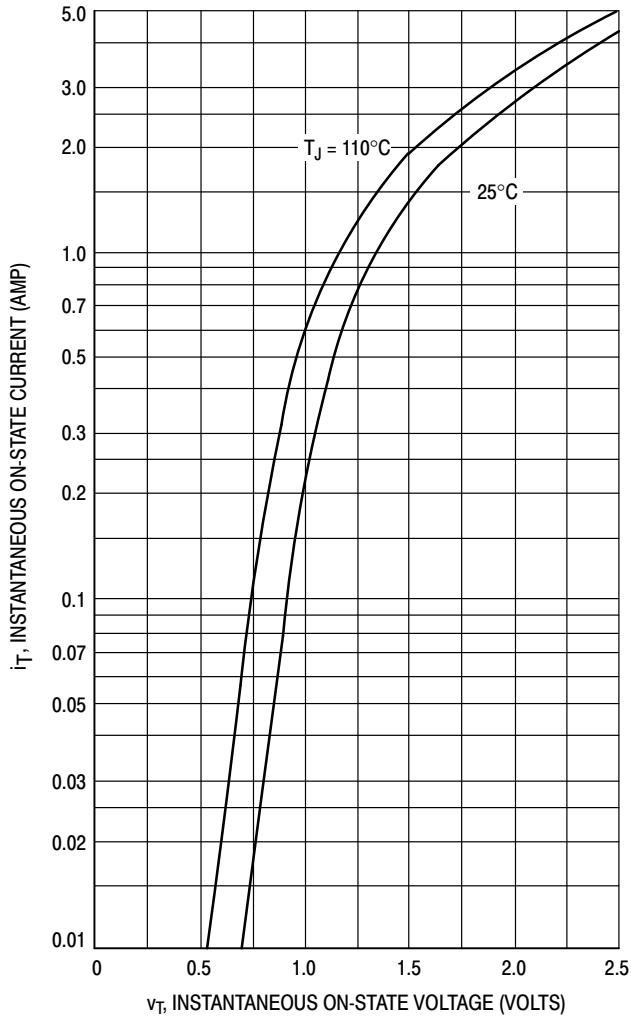

Figure 3. Typical Forward Voltage

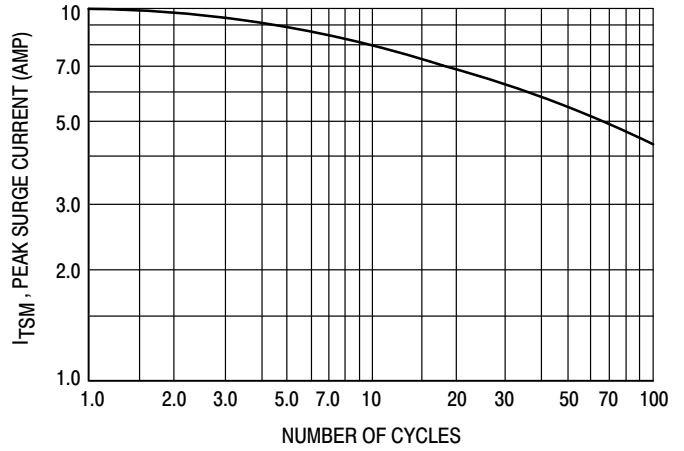

Figure 4. Maximum Non-Repetitive Surge Current

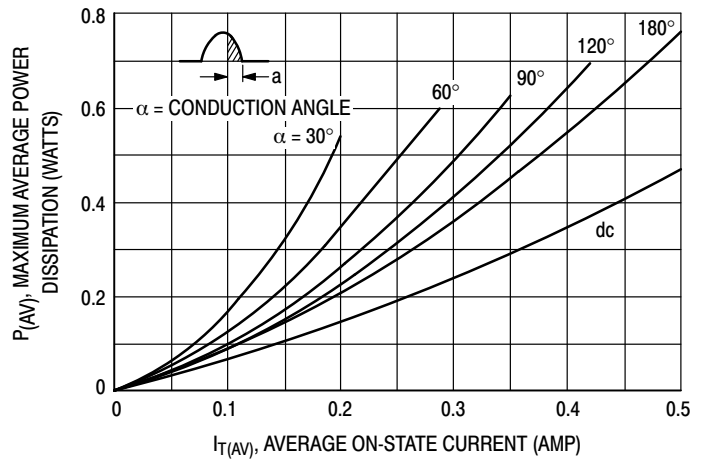

Figure 5. Power Dissipation

## 2N5060 Series

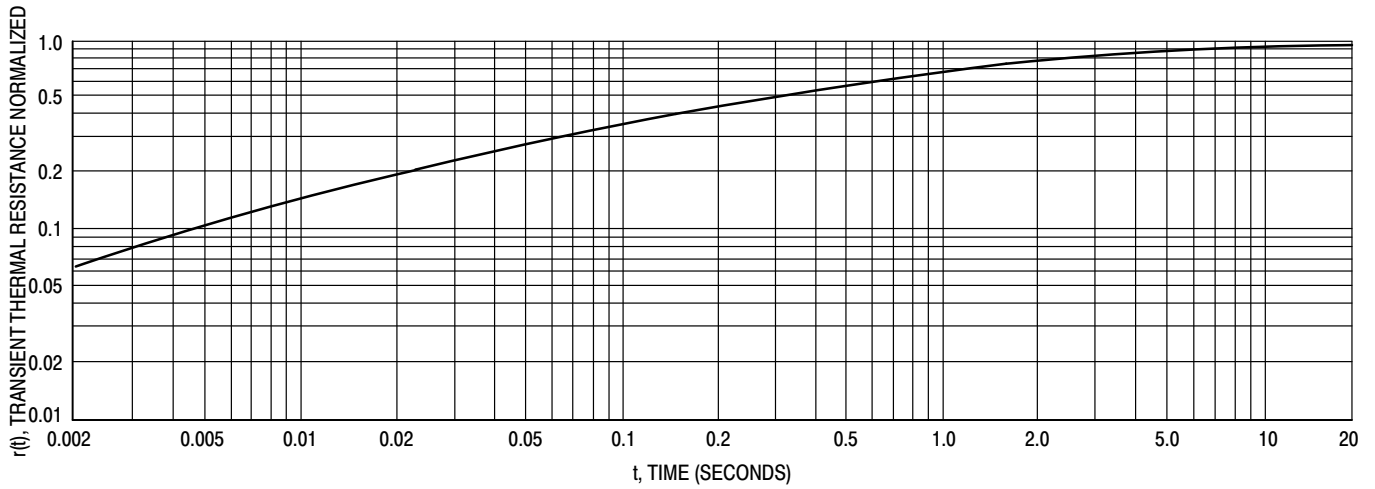

Figure 6. Thermal Response

### TYPICAL CHARACTERISTICS

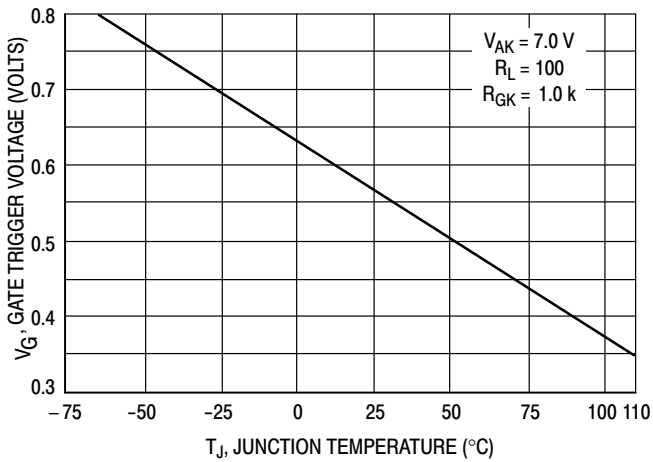

Figure 7. Typical Gate Trigger Voltage

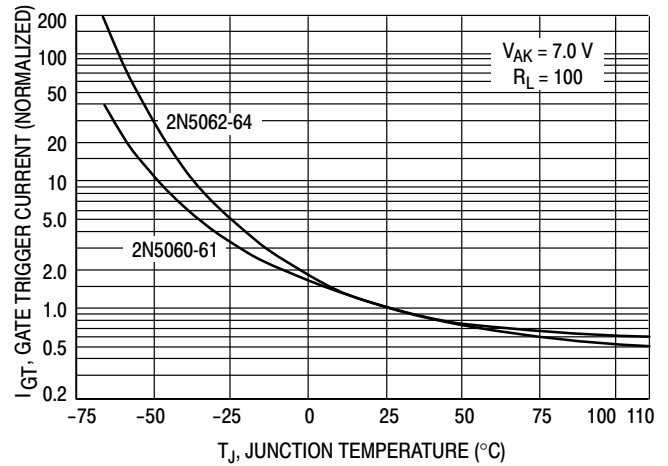

Figure 8. Typical Gate Trigger Current

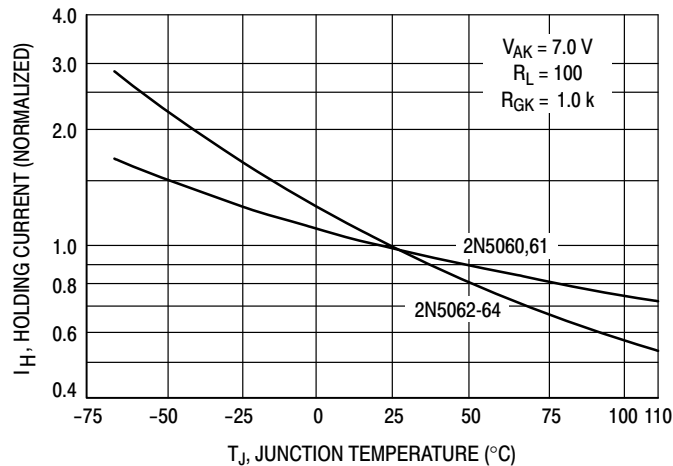

Figure 9. Typical Holding Current

## 2N5060 Series

### ORDERING INFORMATION

Device	Package	Shipping†
2N5060G	TO-92 (Pb-Free)	5000 Units / Box
2N5060RLRA	TO-92	2000 / Tape & Reel
2N5060RLRAG	TO-92 (Pb-Free)	2000 / Tape & Reel
2N5060RLRMG	TO-92 (Pb-Free)	2000 / Ammo Pack
2N5061G	TO-92 (Pb-Free)	5000 Units / Box
2N5061RLRAG	TO-92 (Pb-Free)	2000 / Tape & Reel
2N5062G	TO-92 (Pb-Free)	5000 Units / Box
2N5062RLRAG	TO-92 (Pb-Free)	2000 / Tape & Reel
2N5064RLRMG	TO-92 (Pb-Free)	2000 / Ammo Pack
2N5064RLRAG	TO-92 (Pb-Free)	2000 / Tape & Reel
2N5064G	TO-92 (Pb-Free)	5000 Units / Box

†For information on tape and reel specifications, including part orientation and tape sizes, please refer to our Tape and Reel Packaging Specifications Brochure, BRD8011/D.

# MECHANICAL CASE OUTLINE PACKAGE DIMENSIONS

ON Semiconductor®



SCALE 1:1

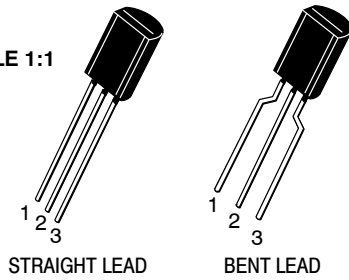

TO-92 (TO-226) 1 WATT  
CASE 29-10  
ISSUE A

DATE 08 MAY 2012

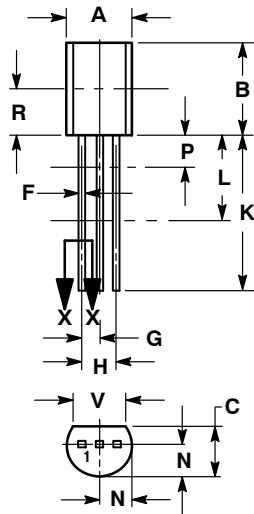

STRAIGHT LEAD

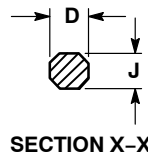

SECTION X-X

NOTES:

1. DIMENSIONING AND TOLERANCING PER ANSI Y14.5M, 1994.
2. CONTROLLING DIMENSION: INCHES.
3. CONTOUR OF PACKAGE BEYOND DIMENSION R IS UNCONTROLLED.
4. DIMENSION F APPLIES BETWEEN DIMENSIONS P AND L. DIMENSIONS D AND J APPLY BETWEEN DIMENSIONS L AND K MINIMUM. THE LEAD DIMENSIONS ARE UNCONTROLLED IN DIMENSION P AND BEYOND DIMENSION K MINIMUM.

DIM	INCHES		MILLIMETERS	
	MIN	MAX	MIN	MAX
A	0.175	0.205	4.44	5.21
B	0.290	0.310	7.37	7.87
C	0.125	0.165	3.18	4.19
D	0.018	0.021	0.46	0.53
F	0.016	0.019	0.41	0.48
G	0.045	0.055	1.15	1.39
H	0.095	0.105	2.42	2.66
J	0.018	0.024	0.46	0.61
K	0.500	---	12.70	---
L	0.250	---	6.35	---
N	0.080	0.105	2.04	2.66
P	---	0.100	---	2.54
R	0.135	---	3.43	---
V	0.135	---	3.43	---

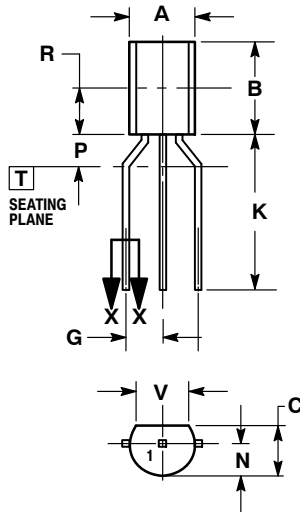

BENT LEAD

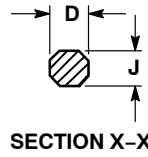

SECTION X-X

NOTES:

1. DIMENSIONING AND TOLERANCING PER ASME Y14.5M, 1994.
2. CONTROLLING DIMENSION: INCHES.
3. CONTOUR OF PACKAGE BEYOND DIMENSION R IS UNCONTROLLED.
4. DIMENSION F APPLIES BETWEEN DIMENSIONS P AND L. DIMENSIONS D AND J APPLY BETWEEN DIMENSIONS L AND K MINIMUM. THE LEAD DIMENSIONS ARE UNCONTROLLED IN DIMENSION P AND BEYOND DIMENSION K MINIMUM.

DIM	INCHES		MILLIMETERS	
	MIN	MAX	MIN	MAX
A	0.175	0.205	4.44	5.21
B	0.290	0.310	7.37	7.87
C	0.125	0.165	3.18	4.19
D	0.018	0.021	0.46	0.53
G	0.094	0.102	2.40	2.80
J	0.018	0.024	0.46	0.61
K	0.500	---	12.70	---
N	0.080	0.105	2.04	2.66
P	---	0.100	---	2.54
R	0.135	---	3.43	---
V	0.135	---	3.43	---

STYLES ON PAGE 2

DOCUMENT NUMBER:	98AON52857E	Electronic versions are uncontrolled except when accessed directly from the Document Repository. Printed versions are uncontrolled except when stamped "CONTROLLED COPY" in red.
DESCRIPTION:	TO-92 (TO-226) 1 WATT	PAGE 1 OF 2

ON Semiconductor and are trademarks of Semiconductor Components Industries, LLC dba ON Semiconductor or its subsidiaries in the United States and/or other countries. ON Semiconductor reserves the right to make changes without further notice to any products herein. ON Semiconductor makes no warranty, representation or guarantee regarding the suitability of its products for any particular purpose, nor does ON Semiconductor assume any liability arising out of the application or use of any product or circuit, and specifically disclaims any and all liability, including without limitation special, consequential or incidental damages. ON Semiconductor does not convey any license under its patent rights nor the rights of others.

**TO-92 (TO-226) 1 WATT  
CASE 29-10  
ISSUE A**

DATE 08 MAY 2012

STYLE 1:  
PIN 1. EMITTER  
2. BASE  
3. COLLECTOR

STYLE 2:  
PIN 1. BASE  
2. EMITTER  
3. COLLECTOR

STYLE 3:  
PIN 1. ANODE  
2. ANODE  
3. CATHODE

STYLE 4:  
PIN 1. CATHODE  
2. CATHODE  
3. ANODE

STYLE 5:  
PIN 1. DRAIN  
2. SOURCE  
3. GATE

STYLE 6:  
PIN 1. GATE  
2. SOURCE & SUBSTRATE  
3. DRAIN

STYLE 7:  
PIN 1. SOURCE  
2. DRAIN  
3. GATE

STYLE 8:  
PIN 1. DRAIN  
2. GATE  
3. SOURCE & SUBSTRATE

STYLE 9:  
PIN 1. BASE 1  
2. EMITTER  
3. BASE 2

STYLE 10:  
PIN 1. CATHODE  
2. GATE  
3. ANODE

STYLE 11:  
PIN 1. ANODE  
2. CATHODE & ANODE  
3. CATHODE

STYLE 12:  
PIN 1. MAIN TERMINAL 1  
2. GATE  
3. MAIN TERMINAL 2

STYLE 13:  
PIN 1. ANODE 1  
2. GATE  
3. CATHODE 2

STYLE 14:  
PIN 1. EMITTER  
2. COLLECTOR  
3. BASE

STYLE 15:  
PIN 1. ANODE 1  
2. CATHODE  
3. ANODE 2

STYLE 16:  
PIN 1. ANODE  
2. GATE  
3. CATHODE

STYLE 17:  
PIN 1. COLLECTOR  
2. BASE  
3. EMITTER

STYLE 18:  
PIN 1. ANODE  
2. CATHODE  
3. NOT CONNECTED

STYLE 19:  
PIN 1. GATE  
2. ANODE  
3. CATHODE

STYLE 20:  
PIN 1. NOT CONNECTED  
2. CATHODE  
3. ANODE

STYLE 21:  
PIN 1. COLLECTOR  
2. EMITTER  
3. BASE

STYLE 22:  
PIN 1. SOURCE  
2. GATE  
3. DRAIN

STYLE 23:  
PIN 1. GATE  
2. SOURCE  
3. DRAIN

STYLE 24:  
PIN 1. EMITTER  
2. COLLECTOR/ANODE  
3. CATHODE

STYLE 25:  
PIN 1. MT 1  
2. GATE  
3. MT 2

STYLE 26:  
PIN 1. V<sub>CC</sub>  
2. GROUND 2  
3. OUTPUT

STYLE 27:  
PIN 1. MT  
2. SUBSTRATE  
3. MT

STYLE 28:  
PIN 1. CATHODE  
2. ANODE  
3. GATE

STYLE 29:  
PIN 1. NOT CONNECTED  
2. ANODE  
3. CATHODE

STYLE 30:  
PIN 1. DRAIN  
2. GATE  
3. SOURCE

STYLE 31:  
PIN 1. GATE  
2. DRAIN  
3. SOURCE

STYLE 32:  
PIN 1. BASE  
2. COLLECTOR  
3. EMITTER

STYLE 33:  
PIN 1. RETURN  
2. INPUT  
3. OUTPUT

STYLE 34:  
PIN 1. INPUT  
2. GROUND  
3. LOGIC

STYLE 35:  
PIN 1. GATE  
2. COLLECTOR  
3. EMITTER

<b>DOCUMENT NUMBER:</b>	<b>98AON52857E</b>	Electronic versions are uncontrolled except when accessed directly from the Document Repository. Printed versions are uncontrolled except when stamped "CONTROLLED COPY" in red.
<b>DESCRIPTION:</b>	<b>TO-92 (TO-226) 1 WATT</b>	<b>PAGE 2 OF 2</b>

ON Semiconductor and  are trademarks of Semiconductor Components Industries, LLC dba ON Semiconductor or its subsidiaries in the United States and/or other countries. ON Semiconductor reserves the right to make changes without further notice to any products herein. ON Semiconductor makes no warranty, representation or guarantee regarding the suitability of its products for any particular purpose, nor does ON Semiconductor assume any liability arising out of the application or use of any product or circuit, and specifically disclaims any and all liability, including without limitation special, consequential or incidental damages. ON Semiconductor does not convey any license under its patent rights nor the rights of others.



ON Semiconductor and  are trademarks of Semiconductor Components Industries, LLC dba ON Semiconductor or its subsidiaries in the United States and/or other countries. ON Semiconductor owns the rights to a number of patents, trademarks, copyrights, trade secrets, and other intellectual property. A listing of ON Semiconductor's product/patent coverage may be accessed at [www.onsemi.com/site/pdf/Patent-Marking.pdf](http://www.onsemi.com/site/pdf/Patent-Marking.pdf). ON Semiconductor reserves the right to make changes without further notice to any products herein. ON Semiconductor makes no warranty, representation or guarantee regarding the suitability of its products for any particular purpose, nor does ON Semiconductor assume any liability arising out of the application or use of any product or circuit, and specifically disclaims any and all liability, including without limitation special, consequential or incidental damages. Buyer is responsible for its products and applications using ON Semiconductor products, including compliance with all laws, regulations and safety requirements or standards, regardless of any support or applications information provided by ON Semiconductor. "Typical" parameters which may be provided in ON Semiconductor data sheets and/or specifications can and do vary in different applications and actual performance may vary over time. All operating parameters, including "Typicals" must be validated for each customer application by customer's technical experts. ON Semiconductor does not convey any license under its patent rights nor the rights of others. ON Semiconductor products are not designed, intended, or authorized for use as a critical component in life support systems or any FDA Class 3 medical devices or medical devices with a same or similar classification in a foreign jurisdiction or any devices intended for implantation in the human body. Should Buyer purchase or use ON Semiconductor products for any such unintended or unauthorized application, Buyer shall indemnify and hold ON Semiconductor and its officers, employees, subsidiaries, affiliates, and distributors harmless against all claims, costs, damages, and expenses, and reasonable attorney fees arising out of, directly or indirectly, any claim of personal injury or death associated with such unintended or unauthorized use, even if such claim alleges that ON Semiconductor was negligent regarding the design or manufacture of the part. ON Semiconductor is an Equal Opportunity/Affirmative Action Employer. This literature is subject to all applicable copyright laws and is not for resale in any manner.

## PUBLICATION ORDERING INFORMATION

### LITERATURE FULFILLMENT:

Email Requests to: [orderlit@onsemi.com](mailto:orderlit@onsemi.com)

ON Semiconductor Website: [www.onsemi.com](http://www.onsemi.com)

### TECHNICAL SUPPORT

North American Technical Support:  
Voice Mail: 1 800-282-9855 Toll Free USA/Canada  
Phone: 011 421 33 790 2910

### Europe, Middle East and Africa Technical Support:

Phone: 00421 33 790 2910

For additional information, please contact your local Sales Representative

