

ON Semiconductor

Is Now

onsemi™

To learn more about onsemi™, please visit our website at
www.onsemi.com

onsemi and **onsemi** and other names, marks, and brands are registered and/or common law trademarks of Semiconductor Components Industries, LLC dba "**onsemi**" or its affiliates and/or subsidiaries in the United States and/or other countries. **onsemi** owns the rights to a number of patents, trademarks, copyrights, trade secrets, and other intellectual property. A listing of **onsemi** product/patent coverage may be accessed at www.onsemi.com/site/pdf/Patent-Marking.pdf. **onsemi** reserves the right to make changes at any time to any products or information herein, without notice. The information herein is provided "as-is" and **onsemi** makes no warranty, representation or guarantee regarding the accuracy of the information, product features, availability, functionality, or suitability of its products for any particular purpose, nor does **onsemi** assume any liability arising out of the application or use of any product or circuit, and specifically disclaims any and all liability, including without limitation special, consequential or incidental damages. Buyer is responsible for its products and applications using **onsemi** products, including compliance with all laws, regulations and safety requirements or standards, regardless of any support or applications information provided by **onsemi**. "Typical" parameters which may be provided in **onsemi** data sheets and/or specifications can and do vary in different applications and actual performance may vary over time. All operating parameters, including "Typicals" must be validated for each customer application by customer's technical experts. **onsemi** does not convey any license under any of its intellectual property rights nor the rights of others. **onsemi** products are not designed, intended, or authorized for use as a critical component in life support systems or any FDA Class 3 medical devices or medical devices with a same or similar classification in a foreign jurisdiction or any devices intended for implantation in the human body. Should Buyer purchase or use **onsemi** products for any such unintended or unauthorized application, Buyer shall indemnify and hold **onsemi** and its officers, employees, subsidiaries, affiliates, and distributors harmless against all claims, costs, damages, and expenses, and reasonable attorney fees arising out of, directly or indirectly, any claim of personal injury or death associated with such unintended or unauthorized use, even if such claim alleges that **onsemi** was negligent regarding the design or manufacture of the part. **onsemi** is an Equal Opportunity/Affirmative Action Employer. This literature is subject to all applicable copyright laws and is not for resale in any manner. Other names and brands may be claimed as the property of others.

Schottky Barrier Rectifiers, Surface Mount, 2 A, 20 V - 150 V

SS22FA - S215FA

Features

- Low Power Loss, High Efficiency
- Guard Ring for Overvoltage Protection
- High Surge Current Capability
- UL Flammability 94V-0 Classification
- MSL 1 per J-STD-020
- Green Molding Compound
- NRVB Prefix for Automotive and Other Applications Requiring Unique Site and Control Change Requirements; AEC-Q101 Qualified and PPAP Capable
- These Devices are Pb-Free and are RoHS Compliant



ON Semiconductor®

www.onsemi.com

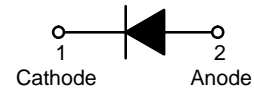

Rectifier



SOD-123FL
CASE 425AB

MARKING DIAGRAM

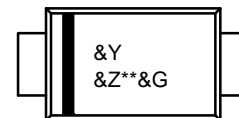

Band Indicates Cathode

- &Y = Binary Calendar Year Coding Scheme
- &Z = Assembly Plant Code
- ** = Specific Device Code
(see "Top Mark" in the table below)
- &G = Single Digit Weekly Date Code

ORDERING INFORMATION

Part Number	Top Mark	Package	Shipping†
SS22FA	22L	SOD-123FL (Pb-Free)	3000 / Tape & Reel
NRVBSS22FA			
SS23FA	23L	SOD-123FL (Pb-Free)	3000 / Tape & Reel
NRVBSS23FA			
SS25FA	25L	SOD-123FL (Pb-Free)	3000 / Tape & Reel
NRVBSS25FA			
SS29FA	29L	SOD-123FL (Pb-Free)	3000 / Tape & Reel
NRVBSS29FA			
S210FA	20L	SOD-123FL (Pb-Free)	3000 / Tape & Reel
NRVBS210FA			
S215FA	2AL	SOD-123FL (Pb-Free)	3000 / Tape & Reel
NRVBS215FA			

†For information on tape and reel specifications, including part orientation and tape sizes, please refer to our Tape and Reel Packaging Specifications Brochure, BRD8011/D.

SS22FA – S215FA

SPECIFICATIONS

ABSOLUTE MAXIMUM RATINGS ($T_A = 25^\circ\text{C}$ unless otherwise noted)

Symbol	Parameter	Value						Unit
		SS22FA	SS23FA	SS25FA	SS29FA	S210FA	S215FA	
V_{RRM}	Repetitive Peak Reverse Voltage	20	30	50	90	100	150	V
V_{RMS}	RMS Reverse Voltage	14	21	35	63	70	105	V
V_R	DC Blocking Voltage	20	30	50	90	100	150	V
$I_{F(AV)}$	Average Forward Rectified Current	2						A
I_{FSM}	Peak Forward Surge Current: 8.3 ms Single Half Sine-Wave Superimposed on Rated Load	50						A
T_J	Operating Junction Temperature Range	-55 to +125		-55 to +150				$^\circ\text{C}$
T_{STG}	Storage Temperature Range	-55 to +150						$^\circ\text{C}$

Stresses exceeding those listed in the Maximum Ratings table may damage the device. If any of these limits are exceeded, device functionality should not be assumed, damage may occur and reliability may be affected.

THERMAL CHARACTERISTICS ($T_A = 25^\circ\text{C}$ unless otherwise noted) (Note 1)

Symbol	Characteristic	Value	Unit
Ψ_{JL}	Junction-to-Lead Thermal Characteristics	16	$^\circ\text{C}/\text{W}$
$R_{\theta JA}$	Junction-to-Ambient Thermal Resistance	152	$^\circ\text{C}/\text{W}$

1. Per JE51-3 Recommended Thermal Test Board. Device mounted on FR-4 PCB, board size = 76.2 mm x 114.3 mm.

ELECTRICAL CHARACTERISTICS ($T_A = 25^\circ\text{C}$ unless otherwise noted)

Symbol	Parameter	Conditions	Value				Unit	
			SS22FA	SS23FA	SS25FA	SS29FA		S210FA
V_F	Maximum Instantaneous Forward Voltage (Note 2)	$I_F = 2\text{ A}$	0.50		0.70	0.85	0.95	V
I_R	Maximum Reverse Current at Rated V_R	$T_J = 25^\circ\text{C}$	0.4		0.1			mA
		$T_J = 100^\circ\text{C}$	15		10			
		$T_J = 125^\circ\text{C}$			5			
C_J	Typical Junction Capacitance	$V_R = 4\text{ V}$, $f = 1\text{ MHz}$	120		93	62	48	pF
T_{rr}	Typical Reverse Recovery Time	$I_F = 0.5\text{ A}$, $I_R = 1\text{ A}$, $I_{RR} = 0.25\text{ A}$	10		9	7	13	ns

Product parametric performance is indicated in the Electrical Characteristics for the listed test conditions, unless otherwise noted. Product performance may not be indicated by the Electrical Characteristics if operated under different conditions.

2. Pulse test with $PW = 300\ \mu\text{s}$, 1% duty cycle.

SS22FA – S215FA

TYPICAL PERFORMANCE CHARACTERISTICS

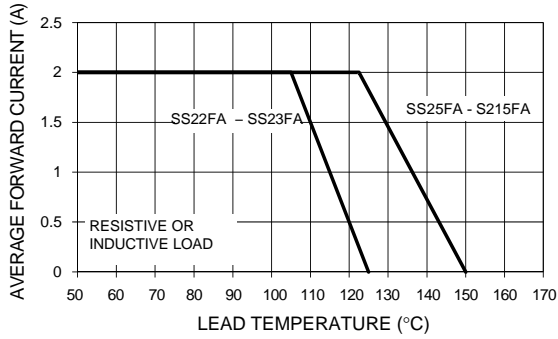

Figure 1. Forward Current Derating Curve

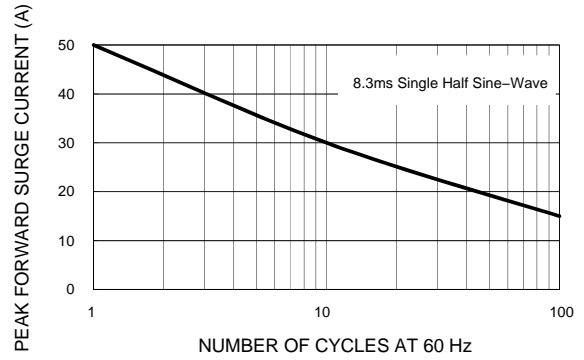

Figure 2. Maximum Non-Repetitive Forward Surge Current

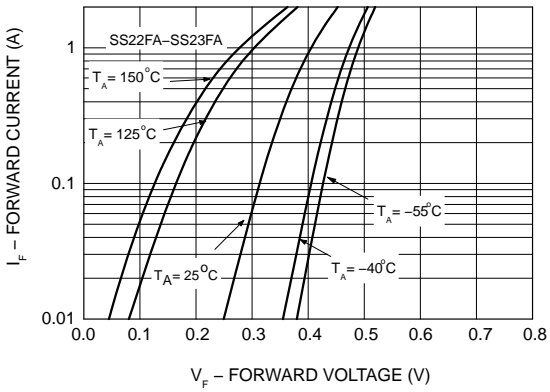

Figure 3. Typical Forward Characteristics

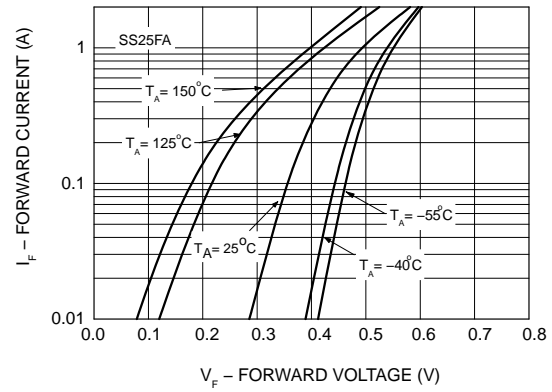

Figure 4. Typical Forward Characteristics

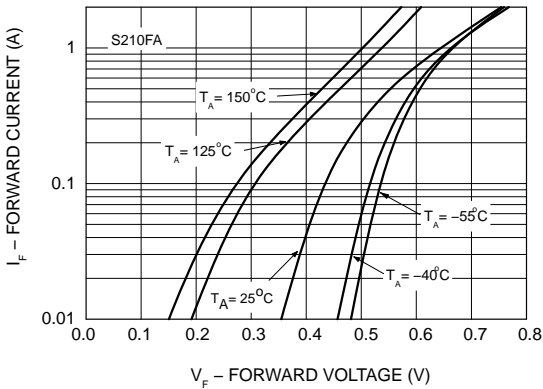

Figure 5. Typical Forward Characteristics

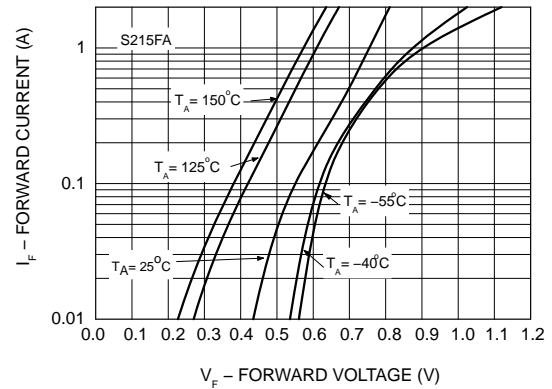

Figure 6. Typical Forward Characteristics

SS22FA – S215FA

TYPICAL PERFORMANCE CHARACTERISTICS (continued)

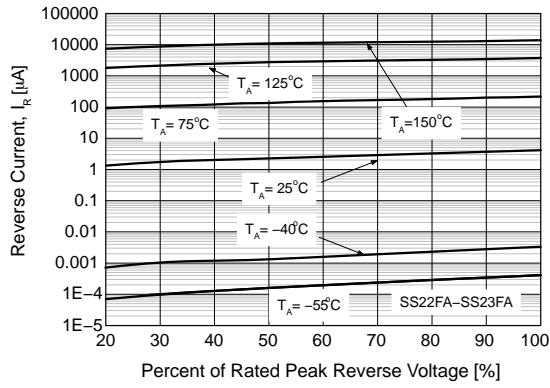

Figure 7. Typical Reverse Characteristics

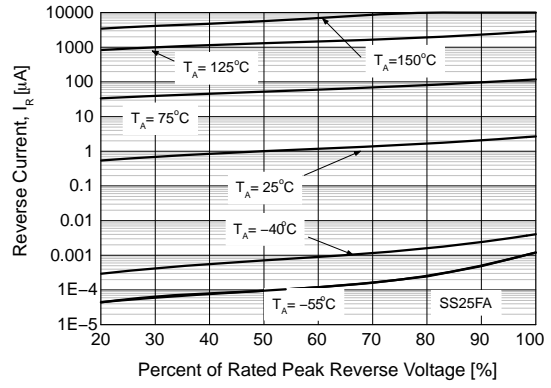

Figure 8. Typical Reverse Characteristics

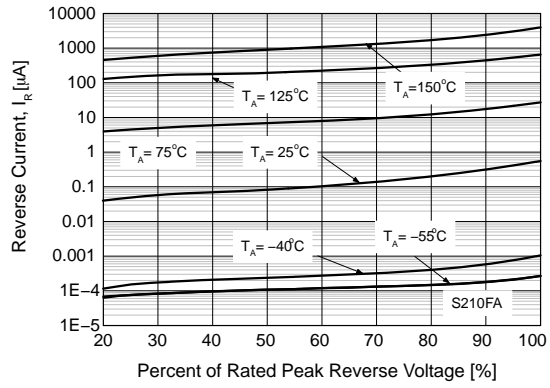

Figure 9. Typical Reverse Characteristics

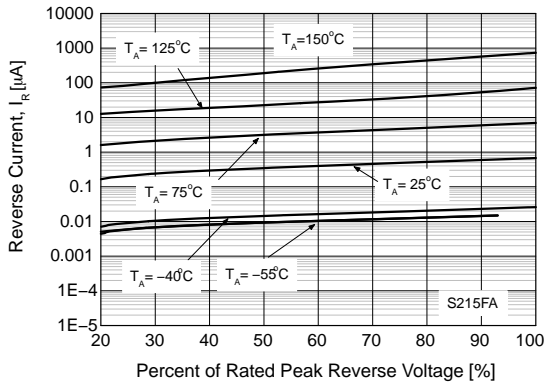

Figure 10. Typical Reverse Characteristics

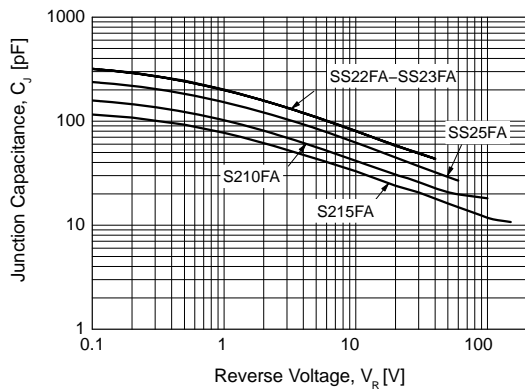

Figure 11. Typical Junction Capacitance

MECHANICAL CASE OUTLINE
PACKAGE DIMENSIONS

ON Semiconductor®



SOD-123FL
CASE 425AB
ISSUE O

DATE 31 AUG 2016

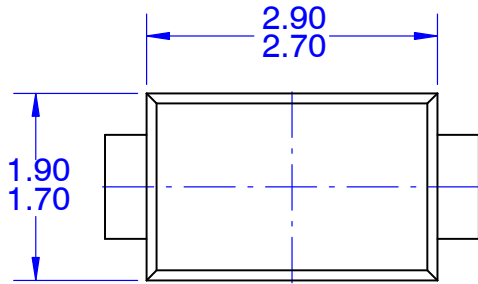

TOP VIEW

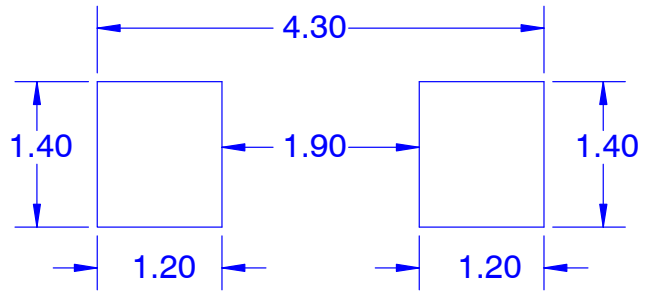

LAND PATTERN RECOMMENDATION

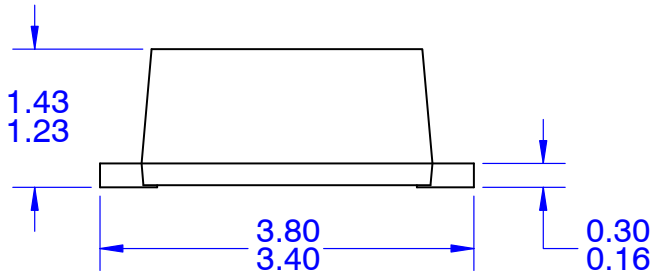

FRONT VIEW

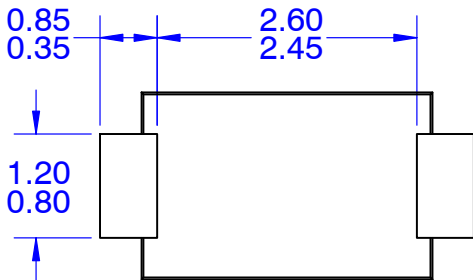

BOTTOM VIEW

NOTES:

- A. NO INDUSTRY STANDARD APPLIES TO THIS PACKAGE.
- B. ALL DIMENSIONS ARE IN MILLIMETERS.
- C. DIMENSIONS ARE EXCLUSIVE OF BURRS, MOLD FLASH AND TIE BAR PROTRUSIONS.

DOCUMENT NUMBER:	98AON13722G	Electronic versions are uncontrolled except when accessed directly from the Document Repository. Printed versions are uncontrolled except when stamped "CONTROLLED COPY" in red.
DESCRIPTION:	SOD-123FL	PAGE 1 OF 1

ON Semiconductor and are trademarks of Semiconductor Components Industries, LLC dba ON Semiconductor or its subsidiaries in the United States and/or other countries. ON Semiconductor reserves the right to make changes without further notice to any products herein. ON Semiconductor makes no warranty, representation or guarantee regarding the suitability of its products for any particular purpose, nor does ON Semiconductor assume any liability arising out of the application or use of any product or circuit, and specifically disclaims any and all liability, including without limitation special, consequential or incidental damages. ON Semiconductor does not convey any license under its patent rights nor the rights of others.

ON Semiconductor and  are trademarks of Semiconductor Components Industries, LLC dba ON Semiconductor or its subsidiaries in the United States and/or other countries. ON Semiconductor owns the rights to a number of patents, trademarks, copyrights, trade secrets, and other intellectual property. A listing of ON Semiconductor's product/patent coverage may be accessed at www.onsemi.com/site/pdf/Patent-Marking.pdf. ON Semiconductor reserves the right to make changes without further notice to any products herein. ON Semiconductor makes no warranty, representation or guarantee regarding the suitability of its products for any particular purpose, nor does ON Semiconductor assume any liability arising out of the application or use of any product or circuit, and specifically disclaims any and all liability, including without limitation special, consequential or incidental damages. Buyer is responsible for its products and applications using ON Semiconductor products, including compliance with all laws, regulations and safety requirements or standards, regardless of any support or applications information provided by ON Semiconductor. "Typical" parameters which may be provided in ON Semiconductor data sheets and/or specifications can and do vary in different applications and actual performance may vary over time. All operating parameters, including "Typicals" must be validated for each customer application by customer's technical experts. ON Semiconductor does not convey any license under its patent rights nor the rights of others. ON Semiconductor products are not designed, intended, or authorized for use as a critical component in life support systems or any FDA Class 3 medical devices or medical devices with a same or similar classification in a foreign jurisdiction or any devices intended for implantation in the human body. Should Buyer purchase or use ON Semiconductor products for any such unintended or unauthorized application, Buyer shall indemnify and hold ON Semiconductor and its officers, employees, subsidiaries, affiliates, and distributors harmless against all claims, costs, damages, and expenses, and reasonable attorney fees arising out of, directly or indirectly, any claim of personal injury or death associated with such unintended or unauthorized use, even if such claim alleges that ON Semiconductor was negligent regarding the design or manufacture of the part. ON Semiconductor is an Equal Opportunity/Affirmative Action Employer. This literature is subject to all applicable copyright laws and is not for resale in any manner.

PUBLICATION ORDERING INFORMATION

LITERATURE FULFILLMENT:

Email Requests to: orderlit@onsemi.com

ON Semiconductor Website: www.onsemi.com

TECHNICAL SUPPORT

North American Technical Support:
Voice Mail: 1 800-282-9855 Toll Free USA/Canada
Phone: 011 421 33 790 2910

Europe, Middle East and Africa Technical Support:

Phone: 00421 33 790 2910

For additional information, please contact your local Sales Representative

