

# ON Semiconductor

## Is Now

# onsemi™

To learn more about onsemi™, please visit our website at  
[www.onsemi.com](http://www.onsemi.com)

**onsemi** and **onsemi** and other names, marks, and brands are registered and/or common law trademarks of Semiconductor Components Industries, LLC dba "**onsemi**" or its affiliates and/or subsidiaries in the United States and/or other countries. **onsemi** owns the rights to a number of patents, trademarks, copyrights, trade secrets, and other intellectual property. A listing of **onsemi** product/patent coverage may be accessed at [www.onsemi.com/site/pdf/Patent-Marking.pdf](http://www.onsemi.com/site/pdf/Patent-Marking.pdf). **onsemi** reserves the right to make changes at any time to any products or information herein, without notice. The information herein is provided "as-is" and **onsemi** makes no warranty, representation or guarantee regarding the accuracy of the information, product features, availability, functionality, or suitability of its products for any particular purpose, nor does **onsemi** assume any liability arising out of the application or use of any product or circuit, and specifically disclaims any and all liability, including without limitation special, consequential or incidental damages. Buyer is responsible for its products and applications using **onsemi** products, including compliance with all laws, regulations and safety requirements or standards, regardless of any support or applications information provided by **onsemi**. "Typical" parameters which may be provided in **onsemi** data sheets and/or specifications can and do vary in different applications and actual performance may vary over time. All operating parameters, including "Typicals" must be validated for each customer application by customer's technical experts. **onsemi** does not convey any license under any of its intellectual property rights nor the rights of others. **onsemi** products are not designed, intended, or authorized for use as a critical component in life support systems or any FDA Class 3 medical devices or medical devices with a same or similar classification in a foreign jurisdiction or any devices intended for implantation in the human body. Should Buyer purchase or use **onsemi** products for any such unintended or unauthorized application, Buyer shall indemnify and hold **onsemi** and its officers, employees, subsidiaries, affiliates, and distributors harmless against all claims, costs, damages, and expenses, and reasonable attorney fees arising out of, directly or indirectly, any claim of personal injury or death associated with such unintended or unauthorized use, even if such claim alleges that **onsemi** was negligent regarding the design or manufacture of the part. **onsemi** is an Equal Opportunity/Affirmative Action Employer. This literature is subject to all applicable copyright laws and is not for resale in any manner. Other names and brands may be claimed as the property of others.

# MC14557B

## 1-to-64 Bit Variable Length Shift Register

The MC14557B is a static clocked serial shift register whose length may be programmed to be any number of bits between 1 and 64. The number of bits selected is equal to the sum of the subscripts of the enabled Length Control inputs (L1, L2, L4, L8, L16, and L32) plus one. Serial data may be selected from the A or B data inputs with the A/B select input. This feature is useful for recirculation purposes. A Clock Enable (CE) input is provided to allow gating of the clock or negative edge clocking capability.

The device can be effectively used for variable digital delay lines or simply to implement odd length shift registers.

- 1–64 Bit Programmable Length
- Q and  $\bar{Q}$  Serial Buffered Outputs
- Asynchronous Master Reset
- All Inputs Buffered
- No Limit On Clock Rise and Fall Times
- Supply Voltage Range = 3.0 Vdc to 18 Vdc
- Capable of Driving Two Low-power TTL Loads or one Low-power Schottky TTL Load Over the Rated Temperature Range
- These Devices are Pb-Free and are RoHS Compliant

### MAXIMUM RATINGS (Voltages Referenced to $V_{SS}$ )

Symbol	Parameter	Value	Unit
$V_{DD}$	DC Supply Voltage Range	-0.5 to +18.0	V
$V_{in}, V_{out}$	Input or Output Voltage Range (DC or Transient)	-0.5 to $V_{DD} + 0.5$	V
$I_{in}, I_{out}$	Input or Output Current (DC or Transient) per Pin	$\pm 10$	mA
$P_D$	Power Dissipation, per Package (Note 2)	500	mW
$T_A$	Ambient Temperature Range	-55 to +125	$^{\circ}\text{C}$
$T_{stg}$	Storage Temperature Range	-65 to +150	$^{\circ}\text{C}$
$T_L$	Lead Temperature (8-Second Soldering)	260	$^{\circ}\text{C}$

Maximum ratings are those values beyond which device damage can occur. Maximum ratings applied to the device are individual stress limit values (not normal operating conditions) and are not valid simultaneously. If these limits are exceeded, device functional operation is not implied, damage may occur and reliability may be affected.

1.  $V_{in}$  and  $V_{out}$  should be constrained to the range  $V_{SS} \leq (V_{in} \text{ or } V_{out}) \leq V_{DD}$ . Unused inputs must always be tied to an appropriate logic voltage level (e.g., either  $V_{SS}$  or  $V_{DD}$ ). Unused outputs must be left open.
2. Temperature Derating:  
Plastic "P and D/DW" Packages: -7.0 mW/ $^{\circ}\text{C}$  From 65 $^{\circ}\text{C}$  To 125 $^{\circ}\text{C}$



ON Semiconductor®

<http://onsemi.com>

### MARKING DIAGRAMS

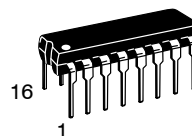

PDIP-16  
P SUFFIX  
CASE 648

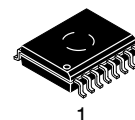
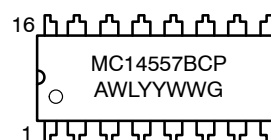

SO-16 WB  
DW SUFFIX  
CASE 751G

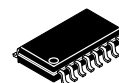
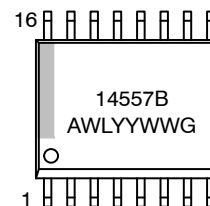

SOEIAJ-16  
F SUFFIX  
CASE 966

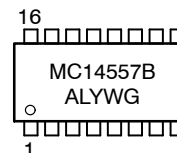

- A = Assembly Location
- WL, L = Wafer Lot
- YY, Y = Year
- WW, W = Work Week
- G = Pb-Free Package

### ORDERING INFORMATION

See detailed ordering and shipping information in the package dimensions section on page 6 of this data sheet.



# MC14557B

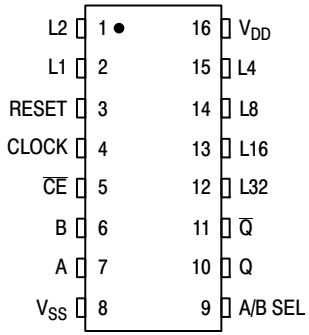

Figure 2. Pin Assignment

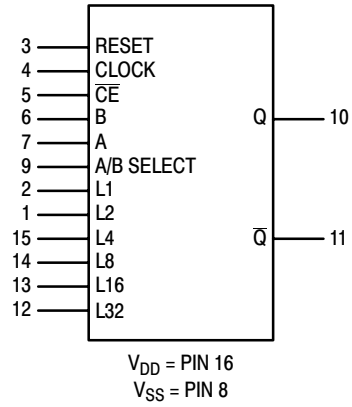

Figure 3. Block Diagram

## TRUTH TABLE

Inputs				Output
Rst	A/B	Clock	CE	Q
0	0	$\int$	0	B
0	1	$\int$	0	A
0	0	1	$\downarrow$	B
0	1	1	$\downarrow$	A
1	X	X	X	0

Q is the output of the first selected shift register stage.  
X = Don't Care

## LENGTH SELECT TRUTH TABLE

L32	L16	L8	L4	L2	L1	Register Length
0	0	0	0	0	0	1 Bit
0	0	0	0	0	1	2 Bits
0	0	0	0	1	0	3 Bits
0	0	0	0	1	1	4 Bits
0	0	0	1	0	0	5 Bits
0	0	0	1	0	1	6 Bits
•	•	•	•	•	•	•
•	•	•	•	•	•	•
•	•	•	•	•	•	•
1	0	0	0	0	0	33 Bits
1	0	0	0	0	1	34 Bits
•	•	•	•	•	•	•
•	•	•	•	•	•	•
•	•	•	•	•	•	•
1	1	1	1	0	0	61 Bits
1	1	1	1	0	1	62 Bits
1	1	1	1	1	0	63 Bits
1	1	1	1	1	1	64 Bits

NOTE: Length equals the sum of the binary length control subscripts plus one.

# MC14557B

## ELECTRICAL CHARACTERISTICS (Voltages Referenced to V<sub>SS</sub>)

Symbol	Characteristic	V <sub>DD</sub> Vdc	- 55°C		25°C			125°C		Unit	
			Min	Max	Min	Typ (Note 3)	Max	Min	Max		
V <sub>OL</sub>	Output Voltage V <sub>in</sub> = V <sub>DD</sub> or 0	"0" Level 5.0 10 15	-	0.05	-	0	0.05	-	0.05	Vdc	
			-	0.05	-	0	0.05	-	0.05		
			-	0.05	-	0	0.05	-	0.05		
V <sub>OH</sub>	V <sub>in</sub> = 0 or V <sub>DD</sub>	"1" Level 5.0 10 15	4.95	-	4.95	5.0	-	4.95	-	Vdc	
			9.95	-	9.95	10	-	9.95	-		
			14.95	-	14.95	15	-	14.95	-		
V <sub>IL</sub>	Input Voltage (V <sub>O</sub> = 4.5 or 0.5 Vdc) (V <sub>O</sub> = 9.0 or 1.0 Vdc) (V <sub>O</sub> = 13.5 or 1.5 Vdc)	"0" Level 5.0 10 15	-	1.5	-	2.25	1.5	-	1.5	Vdc	
			-	3.0	-	4.50	3.0	-	3.0		
			-	4.0	-	6.75	4.0	-	4.0		
V <sub>IH</sub>	(V <sub>O</sub> = 0.5 or 4.5 Vdc) (V <sub>O</sub> = 1.0 or 9.0 Vdc) (V <sub>O</sub> = 1.5 or 13.5 Vdc)	"1" Level 5.0 10 15	3.5	-	3.5	2.75	-	3.5	-	Vdc	
			7.0	-	7.0	5.50	-	7.0	-		
			11	-	11	8.25	-	11	-		
I <sub>OH</sub>	Output Drive Current (V <sub>OH</sub> = 2.5 Vdc) (V <sub>OH</sub> = 4.6 Vdc) (V <sub>OH</sub> = 9.5 Vdc) (V <sub>OH</sub> = 13.5 Vdc)	Source	5.0	-3.0	-	-2.4	-4.2	-	-1.7	-	mAdc
			5.0	-0.64	-	-0.51	-0.88	-	-0.36	-	
			10	-1.6	-	-1.3	-2.25	-	-0.9	-	
			15	-4.2	-	-3.4	-8.8	-	-2.4	-	
I <sub>OL</sub>	(V <sub>OL</sub> = 0.4 Vdc) (V <sub>OL</sub> = 0.5 Vdc) (V <sub>OL</sub> = 1.5 Vdc)	Sink	5.0	0.64	-	0.51	0.88	-	0.36	-	mAdc
			10	1.6	-	1.3	2.25	-	0.9	-	
			15	4.2	-	3.4	8.8	-	2.4	-	
I <sub>in</sub>	Input Current	15	-	±0.1	-	±0.00001	±0.1	-	±1.0	μAdc	
C <sub>in</sub>	Input Capacitance (V <sub>in</sub> = 0)	-	-	-	-	5.0	7.5	-	-	pF	
I <sub>DD</sub>	Quiescent Current (Per Package)	5.0	-	5.0	-	0.010	5.0	-	150	μAdc	
		10	-	10	-	0.020	10	-	300		
		15	-	20	-	0.030	20	-	600		
I <sub>T</sub>	Total Supply Current (Notes 4, 5) (Dynamic plus Quiescent, Per Package) (C <sub>L</sub> = 50 pF on all outputs, all buffers switching)	5.0 10 15	I <sub>T</sub> = (1.75 μA/kHz) f + I <sub>DD</sub> I <sub>T</sub> = (3.50 μA/kHz) f + I <sub>DD</sub> I <sub>T</sub> = (5.25 μA/kHz) f + I <sub>DD</sub>							μAdc	

3. Data labelled "Typ" is not to be used for design purposes but is intended as an indication of the IC's potential performance.

4. The formulas given are for the typical characteristics only at 25°C.

5. To calculate total supply current at loads other than 50 pF: I<sub>T</sub>(C<sub>L</sub>) = I<sub>T</sub>(50 pF) + (C<sub>L</sub> - 50) Vfk where: I<sub>T</sub> is in μA (per package), C<sub>L</sub> in pF, V = (V<sub>DD</sub> - V<sub>SS</sub>) in volts, f in kHz is input frequency, and k = 0.001.

# MC14557B

## SWITCHING CHARACTERISTICS (Note 6) ( $C_L = 50$ pF, $T_A = 25^\circ\text{C}$ )

Symbol	Characteristic	$V_{DD}$	Min	Typ (Note 7)	Max	Unit
$t_{TLH}$ , $t_{THL}$	Rise and Fall Time, Q or $\bar{Q}$ Output $t_{TLH}, t_{THL} = (1.5 \text{ ns/pF}) C_L + 25 \text{ ns}$ $t_{TLH}, t_{THL} = (0.75 \text{ ns/pF}) C_L + 12.5 \text{ ns}$ $t_{TLH}, t_{THL} = (0.55 \text{ ns/pF}) C_L + 9.5 \text{ ns}$	5 10 15	– – –	100 50 40	200 100 80	ns
$t_{PLH}$ , $t_{PHL}$	Propagation Delay, Clock or $\bar{CE}$ to Q or $\bar{Q}$ $t_{PLH}, t_{PHL} = (1.7 \text{ ns/pF}) C_L + 215 \text{ ns}$ $t_{PLH}, t_{PHL} = (0.66 \text{ ns/pF}) C_L + 97 \text{ ns}$ $t_{PLH}, t_{PHL} = (0.5 \text{ ns/pF}) C_L + 65 \text{ ns}$	5 10 15	– – –	300 130 90	600 260 180	ns
$t_{PLH}$ , $t_{PHL}$	Propagation Delay, Reset to Q or $\bar{Q}$ $t_{PLH}, t_{PHL} = (1.7 \text{ ns/pF}) C_L + 215 \text{ ns}$ $t_{PLH}, t_{PHL} = (0.66 \text{ ns/pF}) C_L + 97 \text{ ns}$ $t_{PLH}, t_{PHL} = (0.5 \text{ ns/pF}) C_L + 70 \text{ ns}$	5 10 15	– – –	300 130 95	600 260 190	ns
$t_{WH(cl)}$	Pulse Width, Clock	5 10 15	200 100 75	95 45 35	– – –	ns
$t_{WH(rst)}$	Pulse Width, Reset	5 10 15	300 140 100	150 70 50	– – –	ns
$f_{cl}$	Clock Frequency (50% Duty Cycle)	5 10 15	– – –	3.0 7.5 13.0	1.7 5.0 6.7	MHz
$t_{su}$	Setup Time, A or B to Clock or $\bar{CE}$ Worst case condition: $L1 = L2 = L4 = L8 = L16 = L32 = V_{SS}$ (Register Length = 1)  Best case condition: $L32 = V_{DD}$ , L1 through L16 = Don't Care (Any register length from 33 to 64)	5 10 15  5 10 15	700 290 145  400 165 60	350 130 85  45 5 0	– – –  – – –	ns
$t_h$	Hold Time, Clock or $\bar{CE}$ to A or B Best case condition: $L1 = L2 = L4 = L8 = L16 = L32 = V_{SS}$ (Register Length = 1)  Worst case condition: $L32 = V_{DD}$ , L1 through L16 = Don't Care (Any register length from 33 to 64)	5 10 15  5 10 15	200 100 10  400 185 85	–150 –60 –50  50 25 22	– – –  – – –	ns
$t_r$ , $t_f$	Rise and Fall Time, Clock	5 10 15	No Limit			–
$t_r$ , $t_f$	Rise and Fall Time, Reset or $\bar{CE}$	5 10 15	– – –	– – –	15 5 4	$\mu\text{s}$
$t_{rem}$	Removal Time, Reset to Clock or $\bar{CE}$	5 10 15	160 80 70	80 40 35	– – –	ns

6. The formulas given are for the typical characteristics only at  $25^\circ\text{C}$ .

7. Data labelled "Typ" is not to be used for design purposes but is intended as an indication of the IC's potential performance.

# MC14557B

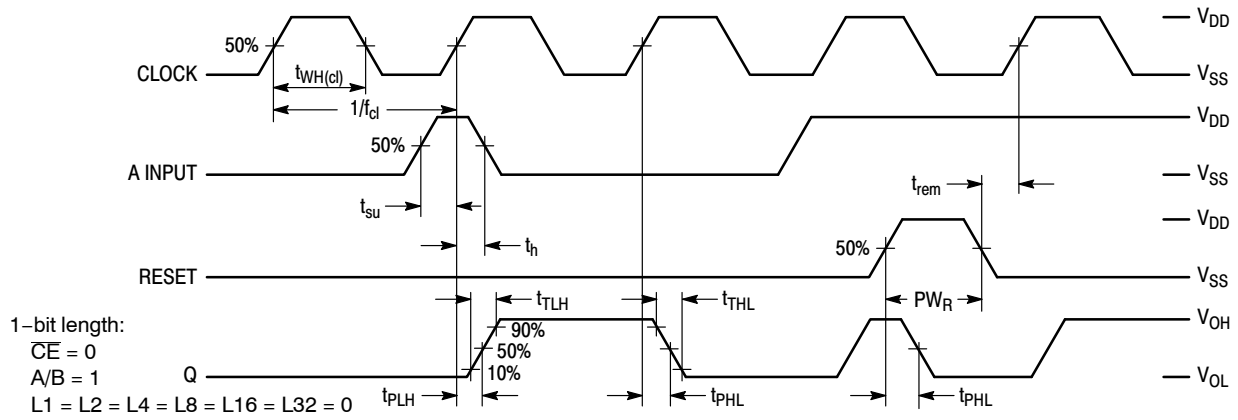

Figure 4. Timing Diagram

## ORDERING INFORMATION

Device	Package	Shipping†
MC14557BFELG	SOEIAJ-16 (Pb-Free)	2000 / Tape & Reel
MC14557BDWR2G	SO-16 (WB)	1000 / Tape & Reel
MC14557BCPG	PDIP-16 (Pb-Free)	500 Units / Rail
MC14557BDWG	SO-16 (WB)	47 Units / Rail

†For information on tape and reel specifications, including part orientation and tape sizes, please refer to our Tape and Reel Packaging Specifications Brochure, BRD8011/D.

# MC14557B

## PACKAGE DIMENSIONS

PDIP-16  
P SUFFIX  
CASE 648-08  
ISSUE T

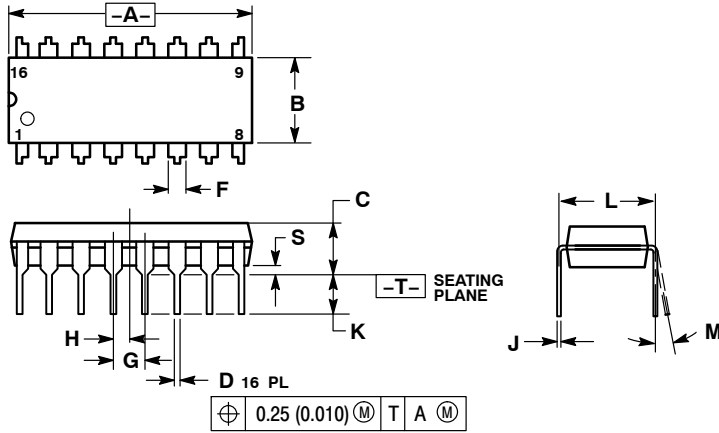

NOTES:

1. DIMENSIONING AND TOLERANCING PER ANSI Y14.5M, 1982.
2. CONTROLLING DIMENSION: INCH.
3. DIMENSION L TO CENTER OF LEADS WHEN FORMED PARALLEL.
4. DIMENSION B DOES NOT INCLUDE MOLD FLASH.
5. ROUNDED CORNERS OPTIONAL.

DIM	INCHES		MILLIMETERS	
	MIN	MAX	MIN	MAX
A	0.740	0.770	18.80	19.55
B	0.250	0.270	6.35	6.85
C	0.145	0.175	3.69	4.44
D	0.015	0.021	0.39	0.53
F	0.040	0.70	1.02	1.77
G	0.100 BSC		2.54 BSC	
H	0.050 BSC		1.27 BSC	
J	0.008	0.015	0.21	0.38
K	0.110	0.130	2.80	3.30
L	0.295	0.305	7.50	7.74
M	0°		10°	
S	0.020	0.040	0.51	1.01

SO-16 WB  
DW SUFFIX  
CASE 751G-03  
ISSUE C

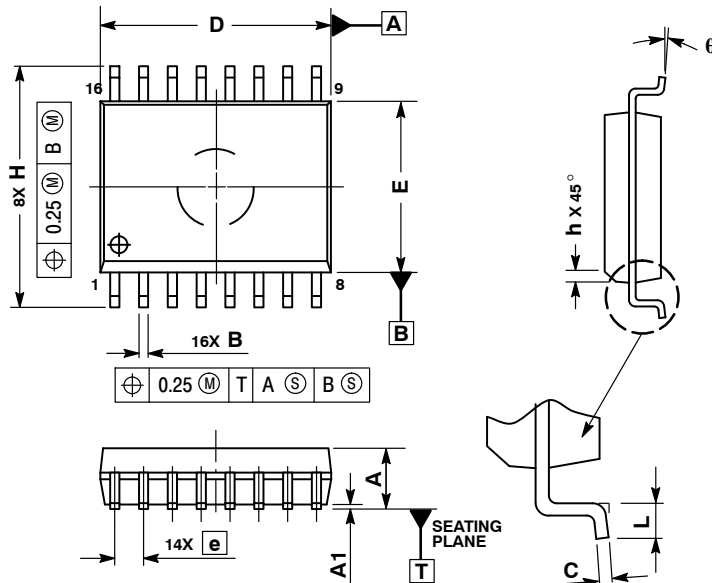

NOTES:

1. DIMENSIONS ARE IN MILLIMETERS.
2. INTERPRET DIMENSIONS AND TOLERANCES PER ASME Y14.5M, 1994.
3. DIMENSIONS D AND E DO NOT INCLUDE MOLD PROTRUSION.
4. MAXIMUM MOLD PROTRUSION 0.15 PER SIDE.
5. DIMENSION B DOES NOT INCLUDE DAMBAR PROTRUSION. ALLOWABLE DAMBAR PROTRUSION SHALL BE 0.13 TOTAL IN EXCESS OF THE B DIMENSION AT MAXIMUM MATERIAL CONDITION.

DIM	MILLIMETERS	
	MIN	MAX
A	2.35	2.65
A1	0.10	0.25
B	0.35	0.49
C	0.23	0.32
D	10.15	10.45
E	7.40	7.60
e	1.27 BSC	
H	10.05	10.55
h	0.25	0.75
L	0.50	0.90
q	0°	
	7°	



# MC14557B

## PACKAGE DIMENSIONS

SOEIAJ-16  
CASE 966-01  
ISSUE A

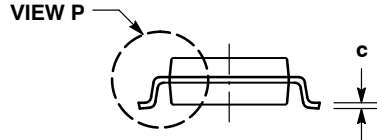
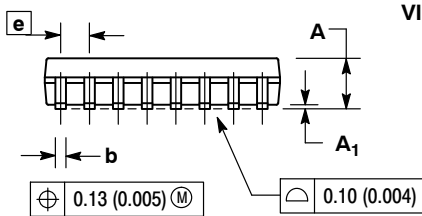
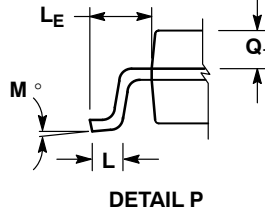
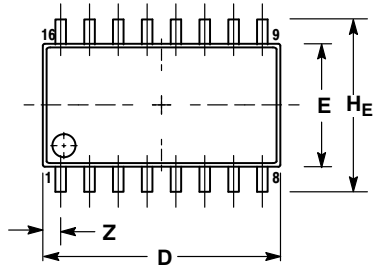

NOTES:

1. DIMENSIONING AND TOLERANCING PER ANSI Y14.5M, 1982.
2. CONTROLLING DIMENSION: MILLIMETER.
3. DIMENSIONS D AND E DO NOT INCLUDE MOLD FLASH OR PROTRUSIONS AND ARE MEASURED AT THE PARTING LINE. MOLD FLASH OR PROTRUSIONS SHALL NOT EXCEED 0.15 (0.006) PER SIDE.
4. TERMINAL NUMBERS ARE SHOWN FOR REFERENCE ONLY.
5. THE LEAD WIDTH DIMENSION (b) DOES NOT INCLUDE DAMBAR PROTRUSION. ALLOWABLE DAMBAR PROTRUSION SHALL BE 0.08 (0.003) TOTAL IN EXCESS OF THE LEAD WIDTH DIMENSION AT MAXIMUM MATERIAL CONDITION. DAMBAR CANNOT BE LOCATED ON THE LOWER RADIUS OR THE FOOT. MINIMUM SPACE BETWEEN PROTRUSIONS AND ADJACENT LEAD TO BE 0.46 (0.018).

DIM	MILLIMETERS		INCHES	
	MIN	MAX	MIN	MAX
A	---	2.05	---	0.081
A <sub>1</sub>	0.05	0.20	0.002	0.008
b	0.35	0.50	0.014	0.020
c	0.10	0.20	0.007	0.011
D	9.90	10.50	0.390	0.413
E	5.10	5.45	0.201	0.215
e	1.27 BSC		0.050 BSC	
H <sub>E</sub>	7.40	8.20	0.291	0.323
L	0.50	0.85	0.020	0.033
L <sub>E</sub>	1.10	1.50	0.043	0.059
M	0°	10°	0°	10°
Q <sub>1</sub>	0.70	0.90	0.028	0.035
Z	---	0.78	---	0.031

ON Semiconductor and are registered trademarks of Semiconductor Components Industries, LLC (SCILLC). SCILLC reserves the right to make changes without further notice to any products herein. SCILLC makes no warranty, representation or guarantee regarding the suitability of its products for any particular purpose, nor does SCILLC assume any liability arising out of the application or use of any product or circuit, and specifically disclaims any and all liability, including without limitation special, consequential or incidental damages. "Typical" parameters which may be provided in SCILLC data sheets and/or specifications can and do vary in different applications and actual performance may vary over time. All operating parameters, including "Typicals" must be validated for each customer application by customer's technical experts. SCILLC does not convey any license under its patent rights nor the rights of others. SCILLC products are not designed, intended, or authorized for use as components in systems intended for surgical implant into the body, or other applications intended to support or sustain life, or for any other application in which the failure of the SCILLC product could create a situation where personal injury or death may occur. Should Buyer purchase or use SCILLC products for any such unintended or unauthorized application, Buyer shall indemnify and hold SCILLC and its officers, employees, subsidiaries, affiliates, and distributors harmless against all claims, costs, damages, and expenses, and reasonable attorney fees arising out of, directly or indirectly, any claim of personal injury or death associated with such unintended or unauthorized use, even if such claim alleges that SCILLC was negligent regarding the design or manufacture of the part. SCILLC is an Equal Opportunity/Affirmative Action Employer. This literature is subject to all applicable copyright laws and is not for resale in any manner.

### PUBLICATION ORDERING INFORMATION

**LITERATURE FULFILLMENT:**

Literature Distribution Center for ON Semiconductor  
P.O. Box 5163, Denver, Colorado 80217 USA  
Phone: 303-675-2175 or 800-344-3860 Toll Free USA/Canada  
Fax: 303-675-2176 or 800-344-3867 Toll Free USA/Canada  
Email: orderlit@onsemi.com

**N. American Technical Support:** 800-282-9855 Toll Free  
USA/Canada  
**Europe, Middle East and Africa Technical Support:**  
Phone: 421 33 790 2910  
**Japan Customer Focus Center**  
Phone: 81-3-5773-3850

**ON Semiconductor Website:** [www.onsemi.com](http://www.onsemi.com)

**Order Literature:** <http://www.onsemi.com/orderlit>

For additional information, please contact your local Sales Representative

MC14557B/D