

# NCS37010

## Self Test With Lockout Ground Fault Circuit Interrupter (GFCI)

The NCS37010 is a fully UL943 compliant signal processor for GFCI applications with self test and lockout. The device integrates a flexible power supply (including both shunt and LDO regulators), differential fault, and grounded-neutral detection circuits. Proprietary impedance measurement and signal processing techniques are used to minimize the number of external components and improve performance. The device also includes a specialized DSP controller that offers best in class immunity to nuisance loads without the need for external analog filters. At power up the NCS37010 performs a self test at 60ms and removes the lockout if the test passes. This self test consists of a differential, ground-neutral and solenoid test.

### Features

- 6.0 – 12 V Operation (120 – 480 V AC Mains with the Appropriate Series Impedance)
- –40 to 85°C
- Very low power consumption: < 15 mW @ 6 V
- 16 Pin QFN or 20 Pin TSSOP Package
- Single Current Transformer (CT) Detection of Both Differential and Grounded-Neutral Faults
- Full Self Test and Trip Indicator Monitoring.
- Self Test on Power Up Enables Lockout Functionality
- Self Syncing Internal Oscillator Adjusts to AC Mains Frequency to Guarantee Full Resolution on 50 and 60 Hz Distribution Systems
- Optimized Solenoid Deployment (Coil is Not Energized Near the AC Mains Zero Crossings)
- Randomized Testing Sequence to Minimize Noise and Potential Interactions on the AC Mains
- >5 mA SCR Driver for Use with High Igt SCR's for Improved Noise Immunity
- Superior Immunity to Nuisance Loads/Noise (up to 10 A) Without Loss of Detection Capability or CT Saturation
- These Devices are Pb-Free, Halogen Free/BFR Free and are RoHS Compliant

### Typical Applications

- Load Panel GFCI Breakers
- GFCI Receptacles
- In-line GFCI Circuits (Power Cords)



ON Semiconductor®

[www.onsemi.com](http://www.onsemi.com)



1  
QFN16  
CASE 485G

### MARKING DIAGRAMS

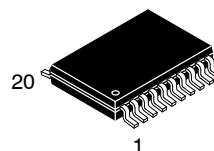
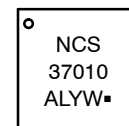

1  
TSSOP-20  
DB SUFFIX  
CASE 948E

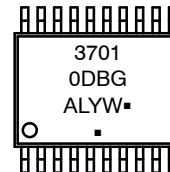

XXXXX = Specific Device Code  
A = Assembly Location  
L = Wafer Lot  
Y = Year  
W = Work Week  
▪ = Pb-Free Package

(Note: Microdot may be in either location)

### PIN CONNECTIONS

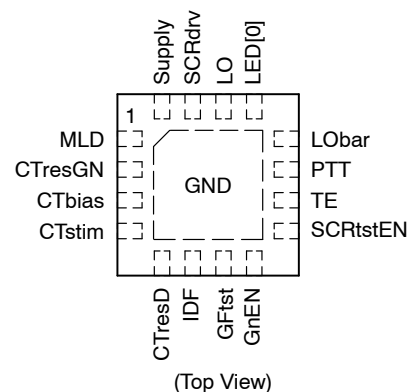

### ORDERING INFORMATION

See detailed ordering and shipping information on page 10 of this data sheet.



# NCS37010

## QFN PIN DESCRIPTION

Pin #	Name	Pad Description
0	Ground	QFN center slug
1	MLD	Mains Level Detect (Zero Cross)
2	CtresGN	Determines IV converter gain for detection threshold / matched to CT turns ratio (Ground-Neutral)
3	Ctbias	Direct connection to the CT
4	Ctstim	Direct connection to the CT
5	CTresD	Determines IV converter gain for detection threshold / matched to CT turns ratio (Differential Current)
6	IDF	Front end noise filter capacitor
7	GFtst	Output to induce external differential current.
8	GnEN	Ground-Neutral fault detection enable pin.
9	SCRtstEN	SCR/solenoid self test enable pin.
10	TE	Tie to Ground or leave floating.
11	PTT	Push to test input.
12	LObar	Load monitor input.
13	LED[0]	LED[0] output driver.
14	LO	Lockout SCR output driver.
15	SCRdrv	Used to trigger the solenoid at a fault detection
16	Supply	Power supply

## TSSOP PIN DESCRIPTION

Pin #	Name	Pad Description
1	CTstim	Differential and ground to neutral stimulus point for the current transformer.
2	Ground	Ground connection for IC.
3	CTresD	Determines IV converter gain for detection threshold / matched to CT turns ratio (Differential Current).
4	IDF	Determines corner frequency of the differential current path filter.
5	GFtst	Output to induce external differential current.
6	GnEN	Ground-Neutral fault detection enable pin.
7	SCRtstEN	SCR/solenoid self test enable pin.
8	TE	Tie to Ground or leave floating.
9	PTT	Push to test input.
10	LObar	Load monitor input.
11	Ground	Ground connection for IC.
12	LED[0]	LED[0] output driver.
13	LO	Lockout SCR output driver.
14	SCRdrv	Used to trigger the solenoid at a fault detection.
15	DVDD	Internal digital 5 V regulated supply.
16	AVDD	Internal analog 5 V regulated supply.
17	Supply	12V shunt regulated power supply.
18	MLD	Mains Level Detect (Zero Cross) and AM slope detect (for oscillator sync/trim and AM init)
19	CtresGN	Determines IV converter gain for detection threshold / matched to CT turns ratio (Ground-Neutral).
20	CTbias	External 2 V bias for the current transformer.

# NCS37010

## ABSOLUTE MAXIMUM RATINGS

Rating	Symbol	Value	Unit
Supply Voltage Range	V <sub>s</sub>	6.0 to 12	V
Input Voltage Range (Note 1)	V <sub>in</sub>	-0.3 to 6.0	V
Output Voltage Range	V <sub>out</sub>	-0.3 to 6.0 V or (V <sub>in</sub> + 0.3), whichever is lower	V
Maximum Junction Temperature	T <sub>J(max)</sub>	140	°C
Storage Temperature Range	T <sub>STG</sub>	-65 to 150	°C
ESD Capability, Human Body Model (Note 2)	ESD <sub>HBM</sub>	2	kV
ESD Capability, Machine Model (Note 2)	ESD <sub>MM</sub>	200	V
Lead Temperature Soldering Reflow (SMD Styles Only), Pb-Free Versions (Note 3)	T <sub>SLD</sub>	260	°C

Stresses exceeding those listed in the Maximum Ratings table may damage the device. If any of these limits are exceeded, device functionality should not be assumed, damage may occur and reliability may be affected.

- Refer to ELECTRICAL CHARACTERISTICS and APPLICATION INFORMATION for Safe Operating Area.
- This device series incorporates ESD protection and is tested by the following methods:  
ESD Human Body Model tested per AEC-Q100-002 (EIA/JESD22-A114)  
ESD Machine Model tested per AEC-Q100-003 (EIA/JESD22-A115)  
Latchup Current Maximum Rating: ≤ 150 mA per JEDEC standard: JESD78
- For information, please refer to our Soldering and Mounting Techniques Reference Manual, SOLDERRM/D

## THERMAL CHARACTERISTICS

Rating	Symbol	Value	Unit
Thermal Characteristics, QFN16, 3x3.3 mm (Note 4) Thermal Resistance, Junction-to-Air (Note 5)	R <sub>θJA</sub>	64	°C/W
Thermal Characteristics, TSSOP-20 (Note 4) Thermal Resistance, Junction-to-Air (Note 5)	R <sub>θJA</sub>	See note above.	°C/W

- Refer to ELECTRICAL CHARACTERISTICS and APPLICATION INFORMATION for Safe Operating Area.
- Values based on copper area of 645 mm<sup>2</sup> (or 1 in<sup>2</sup>) of 1 oz copper thickness and FR4 PCB substrate.

## OPERATING RANGES (Note 6)

Parameter	Conditions	Min	Typ	Max	Unit
Operating Temperature		-40		85	C
IDD in typical power state			2		mA
Stimulus Generator Frequency	Tri-tone	3.1		3.4	kHz
SCR Trigger Current				8	mA
SCR Trigger output voltage	With 5 V supply	4.5		5.5	V
Fault Current Sensitivity	Programmable with CTresD	4.6	4.8	5	mA
Ground Fault Response Time	5 – 20 mA		150		ms
Ground Fault Response Time	20 – 40 mA		75		ms
Ground Fault Response Time	>40 mA		25		ms
Saturation Fault Response Time	>300 mA		1.4		ms
CT Turns Ratio		200		300	
Ground – Neutral Detection Threshold	Total series impedance (Rn and Rg)	3		6	Ω
Internal Oscillator Frequency			2		MHz
CT Stimulus Current	Internally limited			1	mA
CT Driver Closed Loop BW				500	KHz

Product parametric performance is indicated in the Electrical Characteristics for the listed test conditions, unless otherwise noted. Product performance may not be indicated by the Electrical Characteristics if operated under different conditions.

- Refer to ELECTRICAL CHARACTERISTICS and APPLICATION INFORMATION for Safe Operating Area.







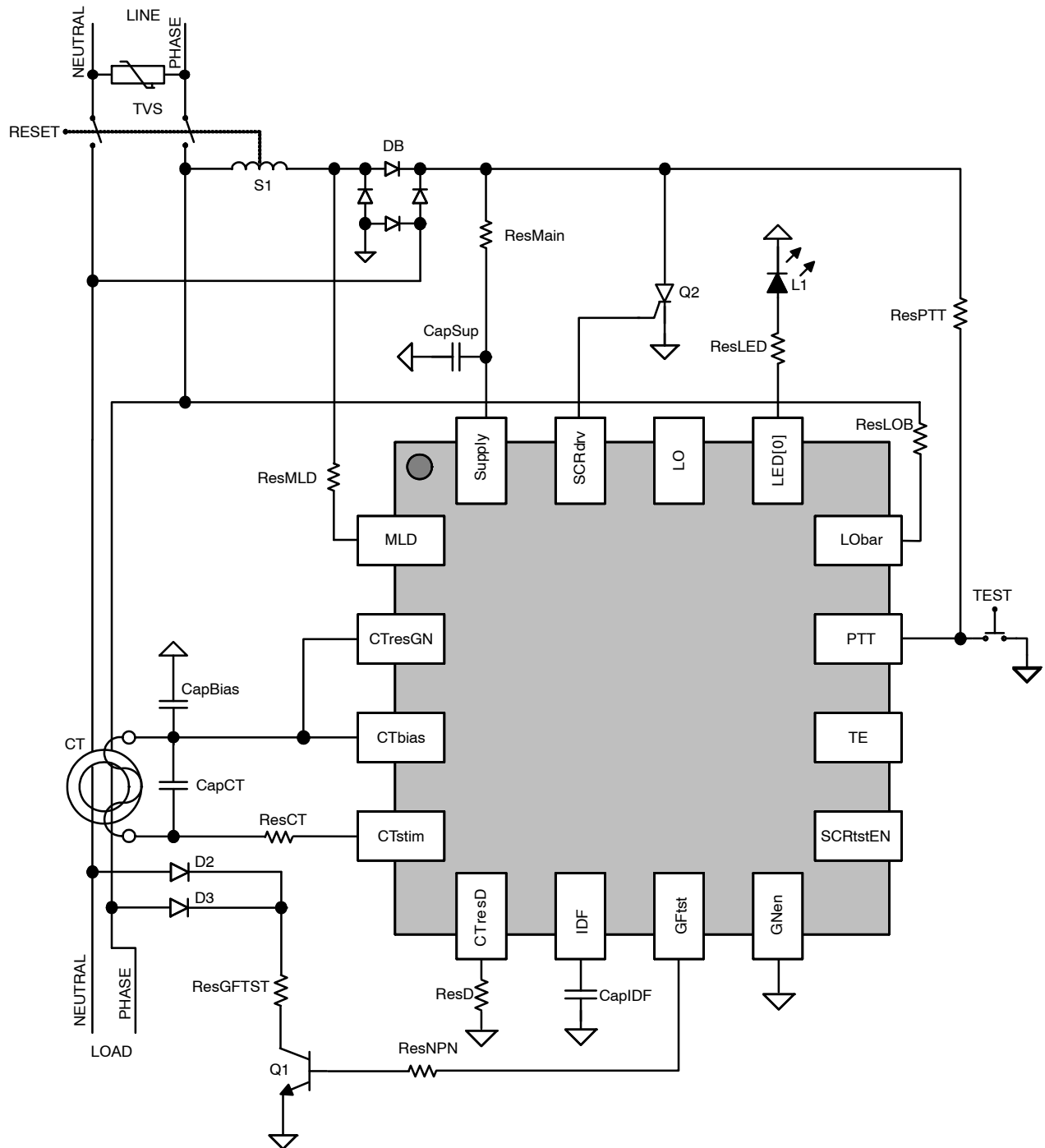

Figure 5. Self Test GFCI Plug (Differential Only)



# NCS37010

## RECOMMENDED EXTERNAL COMPONENTS:

Component Type	Instance	Value	Note
SCR	Q2-Q3	-	ON-MCR08
Diode	Dx	-	ON-1N4007
NPN	Q1	-	ON-MMBT6517LT1G
NMOS	M1		ON-NTK3043K
LED	L1	-	LED pins drive opposite polarities
Capacitor	CapSUP	1 – 4.7 $\mu$ F	For a full bridge rectifier
Capacitor	CapGN	1 – 10 nF	Matched to current transformer
Capacitor	CapIDF	220 nF	Sets the differential corner frequency at 1 kHz
Capacitor	CapBias	10 nF	Filtering component for CTbias voltage.
Capacitor	CapCT	2.2 – 10 nF	Filtering and resonant capacitor for CT.
Capacitor	CapSCR	-	Filtering component.
Resistor	ResD	40 – 80k	Matched to current transformer.
Resistor	ResGN	100 – 400k	Matched to current transformer.
Resistor	ResMLD	400 – 800k	Limiting resistor for the Mains Level Detector (MLD) input.
Resistor	ResTI	400 – 800k	Limiting resistor for the Trip Indicator(TI) input.
Resistor	ResMAIN	8 – 45k	Full bridge rectifier power supply.
Resistor	ResGFTST	1.3 – 30k	Sets the external differential test current (8 mA).
Resistor	ResLED	1 – 5k	Sets the brightness of the LEDs.
Resistor	ResPTT	400 – 800k	Needed for the SCR/Solenoid test.
Resistor	ResNPN	10k	Bias resistor for NPN gate.
TVS	T1	-	~250 – 400 V

## LED FUNCTIONS

Device Function	Device State	Status Indicator (Breaker)
Normal	No Power/ Line Load Reversed	OFF
	Power Up	Blink once within 3 sec (Red)
	Reset (Entered through PTT)	OFF
	Tripped	OFF
Abnormal	Self-Test Fails (Tripped)	OFF
	Self-Test Fails (Reset)	Blink (Red)
	No Trip on Fault	Blink (Red)
	Self-Test Fails to remove Lockout	Blink (Red)

# NCS37010

## Filtering

The analog signal capture portion of the IC includes a single pole filter that can be set externally with Cidf. This provides an additional layer of protection against false tripping under steady state noise conditions. High frequency steady state noise is common with pumps, motors or other cyclic noise generators.

$$Cidf = 220 \text{ nF} = 1 \text{ kHz low pass.}$$

For additional filtering suggestions please contact ON Semiconductor.

## Setting Trip Sensitivity

The CTresD resistor sets the threshold for the differential current fault levels. Increasing CTresD causes the fault levels to trip at lower differential currents. CT efficiency at 60 Hz must be considered.

$$CTresD = 200 * \#Turns - \text{Subject CT efficiency at 60 Hz}$$

The CTresGN resistor sets the threshold for ground to neutral fault detection. The Rt parameter is the desired ground to neutral resistance trip level. Higher CTresGN values will cause the part to trip at higher ground to neutral impedances.

$$CTresGN = \#Turns^2 * Rt / 2 - \text{Subject to CT efficiency from 3 kHz to 4 kHz}$$

## Setting Grounded-Neutral response time

Cgn is used to define the response time of the grounded-neutral detection circuit. The analog portion converts the impedance into a DC voltage and a high frequency (aliased) component. The capacitor is used to remove the high frequency component leaving just the DC representation of the impedance.

$$CTcapGN = 1.8E^{-4} / CTresGN$$

## Self Test

Automatic self test will occur every 17 minutes. If a failure is observed it will be retested every second until it passes. If it fails 3 successive tests then the GFCI will indicate that it has failed self test and will trip. See the LED functions table to see the different self test indicators.

Differential ground fault test – tests the CT and the internal differential detection signal path by asserting the GFtest output high for 1 half cycle. The test will pass if a 6 – 8 mA differential current is enabled during this half wave. Greater than 20 mA current during this test will cause a fault to be detected.

Ground neutral fault test – tests the internal ground neutral stimulus and detection paths by enabling an internal 50k resistor between the CTstim and CTbias pins. If the resistor and capacitor on CTresGN are connected this will pass the GN self test.

Solenoid test – Asserts the SCRdrv output when the voltage on MLD is approximately 4 V. The PTT pin is coupled through a resistor to the output of the bridge rectifier. If the voltage at PTT drops below 2V when the SCRdrv pin is asserted then the test will pass. The SCRdrv output will be de-asserted when the test passes or when it reaches the zero crossing of the MLD pin. The Solenoid/SCR test can be disabled by tying the SCRtstEN pin to electronics ground.

## Lockout

On power-up the NCS37010 will determine connection state of the load by monitoring the LObar input pin. If the load is connected it will continue performing self test every 17 minutes and monitor for differential and GN faults.

If the load is not connected a self test will be performed at 60ms after power-up. If self test passes the connection to the load will be enabled through the LO output which will be asserted for 16 ms.

## PTT

When the PTT input pin is de-asserted for greater than 80 ms a self test will be performed. If this test is successful the SCR will be fired which will trip the GFCI unit. If the test is unsuccessful the LED[0] pin will flash indicating a failure.

## GnEN

The GnEN pin if left floating will enable GN fault detection which will allow for a full UL943 GFCI. If it is tied low then GN detection will be disabled. This setting is ideal for in-line GFCI plugs and breakers that are targeted for differential detection only.

## ORDERING INFORMATION

Device	Package	Shipping†
NCS37010MNTWG	QFN16 (Pb-Free)	3000 / Tape & Reel
NCS37010DBRG	TSSOP-20 (Pb-Free)	2500 / Tape & Reel

†For information on tape and reel specifications, including part orientation and tape sizes, please refer to our Tape and Reel Packaging Specifications Brochure, BRD8011/D.



**QFN16 3x3, 0.5P**  
 CASE 485FQ  
 ISSUE A

DATE 31 JUL 2019

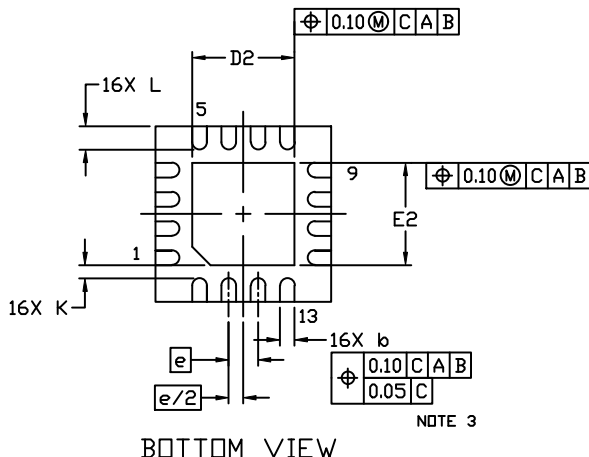
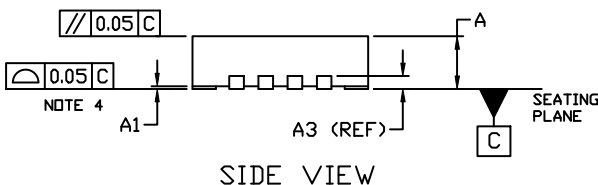
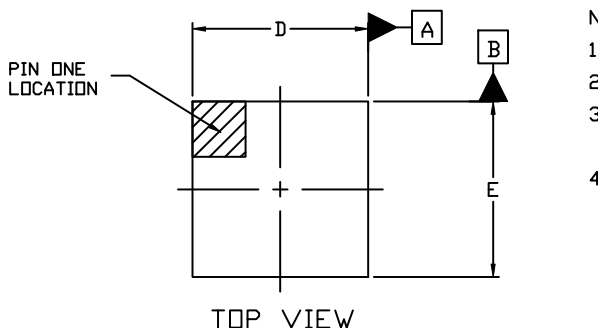

NOTES:

1. DIMENSIONING AND TOLERANCING PER ASME Y14.5M, 1994.
2. CONTROLLING DIMENSION: MILLIMETERS
3. DIMENSION b APPLIES TO PLATED TERMINAL AND IS MEASURED BETWEEN 0.25 AND 0.30 MM FROM THE TERMINAL TIP.
4. COPLANARITY APPLIES TO THE EXPOSED PAD AS WELL AS THE TERMINALS.

DIM	MILLIMETERS		
	MIN.	NOM.	MAX.
A	0.80	0.90	1.00
A1	---	---	0.05
A3	0.20 REF		
b	0.18	0.24	0.30
D	2.95	3.00	3.05
D2	1.70	1.75	1.80
E	2.95	3.00	3.05
E2	1.70	1.75	1.80
e	0.50 BSC		
K	0.18 TYP		
L	0.30	0.40	0.50

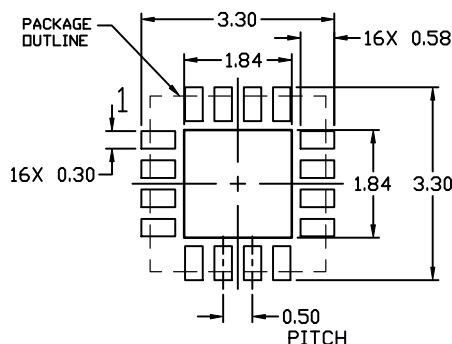

**GENERIC MARKING DIAGRAM\***

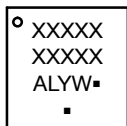

- XXXXX = Specific Device Code
  - A = Assembly Location
  - L = Wafer Lot
  - Y = Year
  - W = Work Week
  - = Pb-Free Package
- (Note: Microdot may be in either location)

\*This information is generic. Please refer to device data sheet for actual part marking. Pb-Free indicator, "G" or microdot "▪", may or may not be present. Some products may not follow the Generic Marking.

<b>DOCUMENT NUMBER:</b>	<b>98AON84763G</b>	Electronic versions are uncontrolled except when accessed directly from the Document Repository. Printed versions are uncontrolled except when stamped "CONTROLLED COPY" in red.
<b>DESCRIPTION:</b>	<b>QFN16 3x3, 0.5P</b>	<b>PAGE 1 OF 1</b>

ON Semiconductor and ON are trademarks of Semiconductor Components Industries, LLC dba ON Semiconductor or its subsidiaries in the United States and/or other countries. ON Semiconductor reserves the right to make changes without further notice to any products herein. ON Semiconductor makes no warranty, representation or guarantee regarding the suitability of its products for any particular purpose, nor does ON Semiconductor assume any liability arising out of the application or use of any product or circuit, and specifically disclaims any and all liability, including without limitation special, consequential or incidental damages. ON Semiconductor does not convey any license under its patent rights nor the rights of others.

# MECHANICAL CASE OUTLINE

## PACKAGE DIMENSIONS

ON Semiconductor®

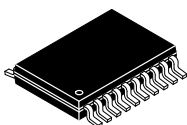

TSSOP-20 WB  
CASE 948E  
ISSUE D

DATE 17 FEB 2016

SCALE 2:1

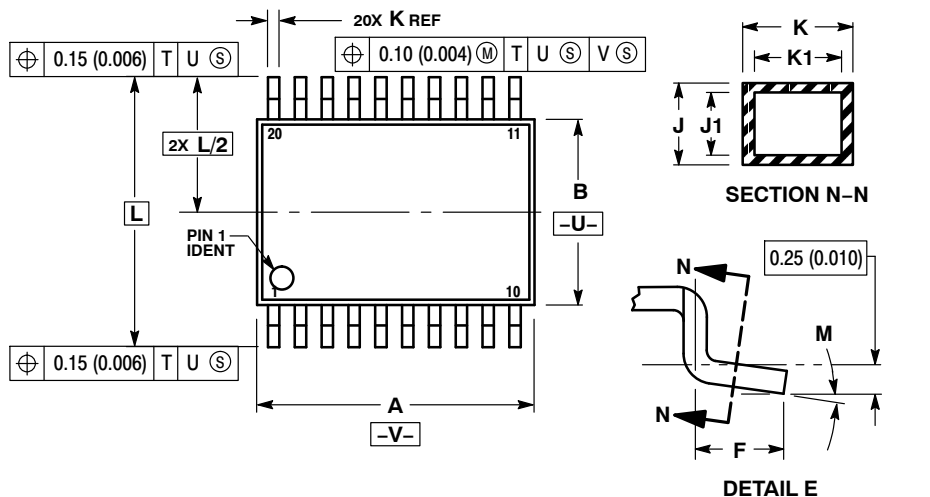

- NOTES:
1. DIMENSIONING AND TOLERANCING PER ANSI Y14.5M, 1982.
  2. CONTROLLING DIMENSION: MILLIMETER.
  3. DIMENSION A DOES NOT INCLUDE MOLD FLASH, PROTRUSIONS OR GATE BURRS. MOLD FLASH OR GATE BURRS SHALL NOT EXCEED 0.15 (0.006) PER SIDE.
  4. DIMENSION B DOES NOT INCLUDE INTERLEAD FLASH OR PROTRUSION. INTERLEAD FLASH OR PROTRUSION SHALL NOT EXCEED 0.25 (0.010) PER SIDE.
  5. DIMENSION K DOES NOT INCLUDE DAMBAR PROTRUSION. ALLOWABLE DAMBAR PROTRUSION SHALL BE 0.08 (0.003) TOTAL IN EXCESS OF THE K DIMENSION AT MAXIMUM MATERIAL CONDITION.
  6. TERMINAL NUMBERS ARE SHOWN FOR REFERENCE ONLY.
  7. DIMENSION A AND B ARE TO BE DETERMINED AT DATUM PLANE -W-.

DIM	MILLIMETERS		INCHES	
	MIN	MAX	MIN	MAX
A	6.40	6.60	0.252	0.260
B	4.30	4.50	0.169	0.177
C	---	1.20	---	0.047
D	0.05	0.15	0.002	0.006
F	0.50	0.75	0.020	0.030
G	0.65 BSC		0.026 BSC	
H	0.27	0.37	0.011	0.015
J	0.09	0.20	0.004	0.008
J1	0.09	0.16	0.004	0.006
K	0.19	0.30	0.007	0.012
K1	0.19	0.25	0.007	0.010
L	6.40 BSC		0.252 BSC	
M	0°	8°	0°	8°

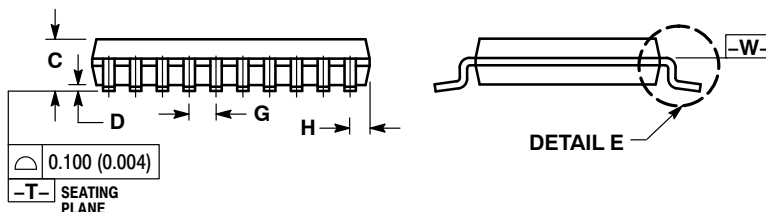

### SOLDERING FOOTPRINT

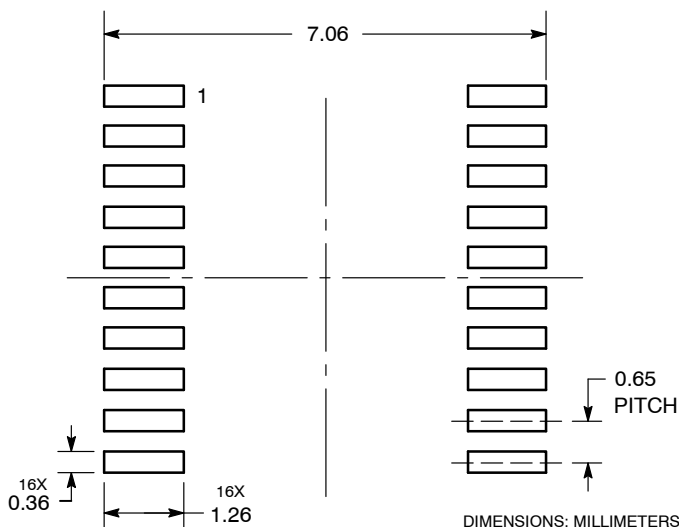

### GENERIC MARKING DIAGRAM\*

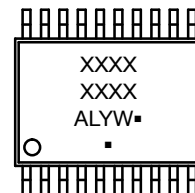

- A = Assembly Location
- L = Wafer Lot
- Y = Year
- W = Work Week
- = Pb-Free Package

(Note: Microdot may be in either location)

\*This information is generic. Please refer to device data sheet for actual part marking. Pb-Free indicator, "G" or microdot "▪", may or may not be present.

DOCUMENT NUMBER:	98ASH70169A	Electronic versions are uncontrolled except when accessed directly from the Document Repository. Printed versions are uncontrolled except when stamped "CONTROLLED COPY" in red.
DESCRIPTION:	TSSOP-20 WB	PAGE 1 OF 1

ON Semiconductor and ON are trademarks of Semiconductor Components Industries, LLC dba ON Semiconductor or its subsidiaries in the United States and/or other countries. ON Semiconductor reserves the right to make changes without further notice to any products herein. ON Semiconductor makes no warranty, representation or guarantee regarding the suitability of its products for any particular purpose, nor does ON Semiconductor assume any liability arising out of the application or use of any product or circuit, and specifically disclaims any and all liability, including without limitation special, consequential or incidental damages. ON Semiconductor does not convey any license under its patent rights nor the rights of others.

**onsemi**, **Onsemi**, and other names, marks, and brands are registered and/or common law trademarks of Semiconductor Components Industries, LLC dba "**onsemi**" or its affiliates and/or subsidiaries in the United States and/or other countries. **onsemi** owns the rights to a number of patents, trademarks, copyrights, trade secrets, and other intellectual property. A listing of **onsemi**'s product/patent coverage may be accessed at [www.onsemi.com/site/pdf/Patent-Marking.pdf](http://www.onsemi.com/site/pdf/Patent-Marking.pdf). **onsemi** reserves the right to make changes at any time to any products or information herein, without notice. The information herein is provided "as-is" and **onsemi** makes no warranty, representation or guarantee regarding the accuracy of the information, product features, availability, functionality, or suitability of its products for any particular purpose, nor does **onsemi** assume any liability arising out of the application or use of any product or circuit, and specifically disclaims any and all liability, including without limitation special, consequential or incidental damages. Buyer is responsible for its products and applications using **onsemi** products, including compliance with all laws, regulations and safety requirements or standards, regardless of any support or applications information provided by **onsemi**. "Typical" parameters which may be provided in **onsemi** data sheets and/or specifications can and do vary in different applications and actual performance may vary over time. All operating parameters, including "Typicals" must be validated for each customer application by customer's technical experts. **onsemi** does not convey any license under any of its intellectual property rights nor the rights of others. **onsemi** products are not designed, intended, or authorized for use as a critical component in life support systems or any FDA Class 3 medical devices or medical devices with a same or similar classification in a foreign jurisdiction or any devices intended for implantation in the human body. Should Buyer purchase or use **onsemi** products for any such unintended or unauthorized application, Buyer shall indemnify and hold **onsemi** and its officers, employees, subsidiaries, affiliates, and distributors harmless against all claims, costs, damages, and expenses, and reasonable attorney fees arising out of, directly or indirectly, any claim of personal injury or death associated with such unintended or unauthorized use, even if such claim alleges that **onsemi** was negligent regarding the design or manufacture of the part. **onsemi** is an Equal Opportunity/Affirmative Action Employer. This literature is subject to all applicable copyright laws and is not for resale in any manner.

## PUBLICATION ORDERING INFORMATION

### LITERATURE FULFILLMENT:

Email Requests to: [orderlit@onsemi.com](mailto:orderlit@onsemi.com)

**onsemi Website:** [www.onsemi.com](http://www.onsemi.com)

### TECHNICAL SUPPORT

**North American Technical Support:**

Voice Mail: 1 800-282-9855 Toll Free USA/Canada

Phone: 011 421 33 790 2910

**Europe, Middle East and Africa Technical Support:**

Phone: 00421 33 790 2910

For additional information, please contact your local Sales Representative

