

## MEMS audio sensor omnidirectional digital microphone

Datasheet – production data

### Features

- Single supply voltage
- Low power consumption
- 120 dB SPL acoustic overload point
- 62.6 dB signal-to-noise ratio
- Omnidirectional sensitivity
- -26 dBFS sensitivity
- PDM single-bit output with option for stereo configuration
- RHLGA package
  - Bottom-port design
  - SMD-compliant
  - EMI-shielded
  - ECOPACK®, RoHS and “Green” compliant

### Applications

- Mobile terminals
- Laptop and notebook computers
- Portable media players
- VoIP
- Speech recognition
- A/V eLearning devices
- Gaming and virtual reality input devices
- Digital still and video cameras
- Antitheft systems

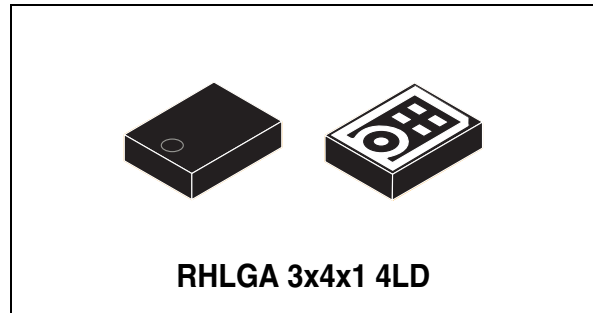

### Description

The MP34DB01 is an ultra-compact, low-power, omnidirectional, digital MEMS microphone built with a capacitive sensing element and an IC interface with stereo operation capability.

The sensing element, capable of detecting acoustic waves, is manufactured using a specialized silicon micromachining process dedicated to produce audio sensors.

The IC interface is manufactured using a CMOS process that allows designing a dedicated circuit able to provide a digital signal externally in PDM format.

The MP34DB01 has an acoustic overload point of 120 dB SPL with a best on the market 62.6 dB signal-to-noise ratio and -26 dBFS sensitivity.

The MP34DB01 is available in a bottom-port, SMD-compliant, EMI-shielded package and is guaranteed to operate over an extended temperature range from -40 °C to +85 °C.

**Table 1. Device summary**

Part number	Temperature range [°C]	Package	Packing
MP34DB01	-40 to +85	RHLGA (3x4x1) mm 4LD	Tray
MP34DB01TR	-40 to +85	RHLGA (3x4x1) mm 4LD	Tape and reel

# Contents

<b>1</b>	<b>Pin description</b> .....	<b>5</b>
<b>2</b>	<b>Acoustic and electrical specifications</b> .....	<b>6</b>
2.1	Acoustic and electrical characteristics .....	6
2.2	Timing characteristics .....	7
2.3	Frequency response .....	8
<b>3</b>	<b>Sensing element</b> .....	<b>9</b>
<b>4</b>	<b>Absolute maximum ratings</b> .....	<b>10</b>
<b>5</b>	<b>Functionality</b> .....	<b>11</b>
5.1	L/R channel selection .....	11
<b>6</b>	<b>Application recommendations</b> .....	<b>12</b>
<b>7</b>	<b>Package mechanical data</b> .....	<b>13</b>
<b>8</b>	<b>Revision history</b> .....	<b>15</b>

## List of tables

Table 1.	Device summary . . . . .	1
Table 2.	Pin description . . . . .	5
Table 3.	Acoustic and electrical characteristics . . . . .	6
Table 4.	Distortion specifications . . . . .	6
Table 5.	Timing characteristics . . . . .	7
Table 6.	Frequency response mask for digital microphones . . . . .	8
Table 7.	Absolute maximum ratings . . . . .	10
Table 8.	L/R channel selection . . . . .	11
Table 9.	Recommended soldering profile limits . . . . .	13
Table 10.	RHLGA 3 mm x 4 mm x 1 mm 4-lead package dimensions . . . . .	14
Table 11.	Document revision history . . . . .	15

## List of figures

Figure 1.	Pin connections . . . . .	5
Figure 2.	Timing waveforms . . . . .	7
Figure 3.	Typical frequency response normalized at 1 kHz . . . . .	8
Figure 4.	MP34DB01 electrical connections . . . . .	12
Figure 5.	MP34DB01 electrical connections for stereo configuration . . . . .	12
Figure 6.	Recommended soldering profile limits . . . . .	13
Figure 7.	RHLGA 3 mm x 4 mm x 1 mm 4-lead package outline . . . . .	14

# 1 Pin description

Figure 1. Pin connections

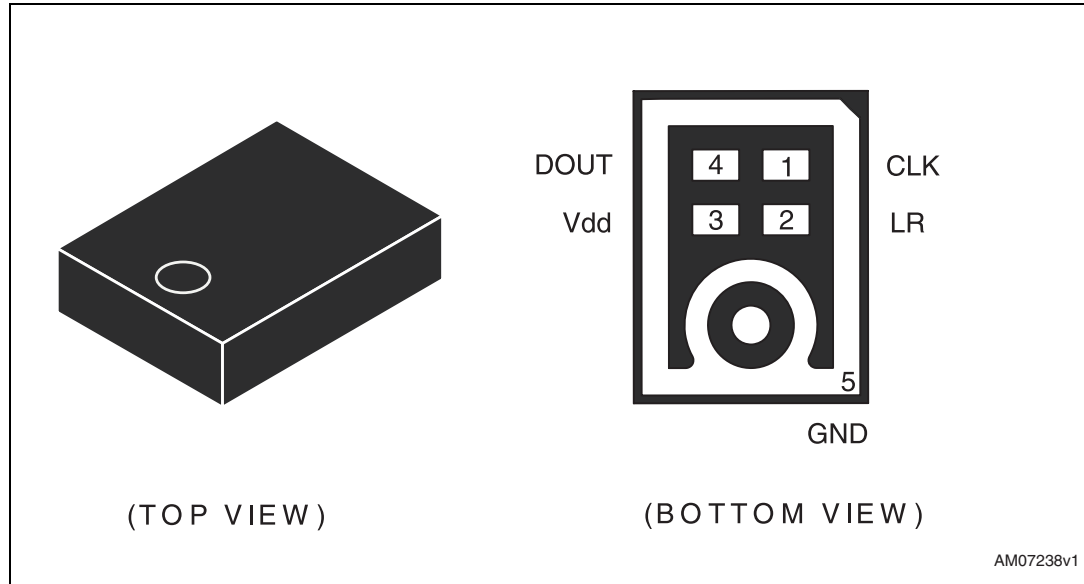

Table 2. Pin description

Pin #	Pin name	Function
1	CLK	Synchronization input clock
2	LR	Left/right channel selection
3	Vdd	Power supply
4	DOUT	Left/right PDM data output
5 (ground ring)	GND	0 V supply

## 2 Acoustic and electrical specifications

### 2.1 Acoustic and electrical characteristics

The values listed in the table below are specified for Vdd = 1.8 V, Clock = 2.4 MHz, T = 25 °C, unless otherwise noted.

**Table 3. Acoustic and electrical characteristics**

Symbol	Parameter	Test condition	Min.	Typ. <sup>(1)</sup>	Max.	Unit
Vdd	Supply voltage		1.64	1.8	3.6	V
Idd	Current consumption in normal mode	Mean value <sup>(2)</sup>		0.65		mA
IddPdn	Current consumption in power-down mode <sup>(3)</sup>			20		µA
Sc	Short-circuit current		1		10	mA
AOP	Acoustic overload point			120		dB SPL
So	Sensitivity	at 1 kHz, 1 Pa	-29	-26	-23	dBFS
SNR	Signal-to-noise ratio	A-weighted at 1 kHz, 1 Pa		62.6		dB
PSR	Power supply rejection	Guaranteed by design		-70		dBFS
Clock	Input clock frequency <sup>(4)</sup>		1	2.4	3.25	MHz
TWK	Wake-up time <sup>(5)</sup>	Guaranteed by design			10	ms
Top	Operating temperature range		-40		+85	°C
V <sub>IOL</sub>	Low level logic input/output voltage	I <sub>out</sub> = 1 mA	-0.3		0.35xVdd	V
V <sub>IOH</sub>	High level logic input/output voltage	I <sub>out</sub> = 1 mA	0.65xVdd		Vdd+0.3	V

1. Typical specifications are not guaranteed.
2. No load on DOUT line.
3. Input clock in static mode.
4. Duty cycle: min = 40% max = 60%
5. Time from the first clock edge to valid output data.

**Table 4. Distortion specifications**

Parameter	Test condition	Value
Distortion	100 dB SPL (50 Hz - 4 kHz)	< 1% THD + N
Distortion	115 dB SPL (1 kHz)	< 5% THD + N

## 2.2 Timing characteristics

**Table 5. Timing characteristics**

Parameter	Description	Min	Max	Unit
$f_{CLK}$	Clock frequency for normal mode	1	3.25	MHz
$f_{PD}$	Clock frequency for power-down mode		0.23	MHz
$T_{CLK}$	Clock period for normal mode	308	1000	ns
$T_{R,EN}$	Data enabled on DATA line, L/R pin = 1	30 <sup>(1)</sup>		ns
$T_{R,DIS}$	Data disabled on DATA line, L/R pin = 1		16 <sup>(1)</sup>	ns
$T_{L,EN}$	Data enabled on DATA line, L/R pin = 0	30 <sup>(1)</sup>		ns
$T_{L,DIS}$	Data disabled on DATA line, L/R pin = 0		16 <sup>(1)</sup>	ns

1. From design simulations

**Figure 2. Timing waveforms**

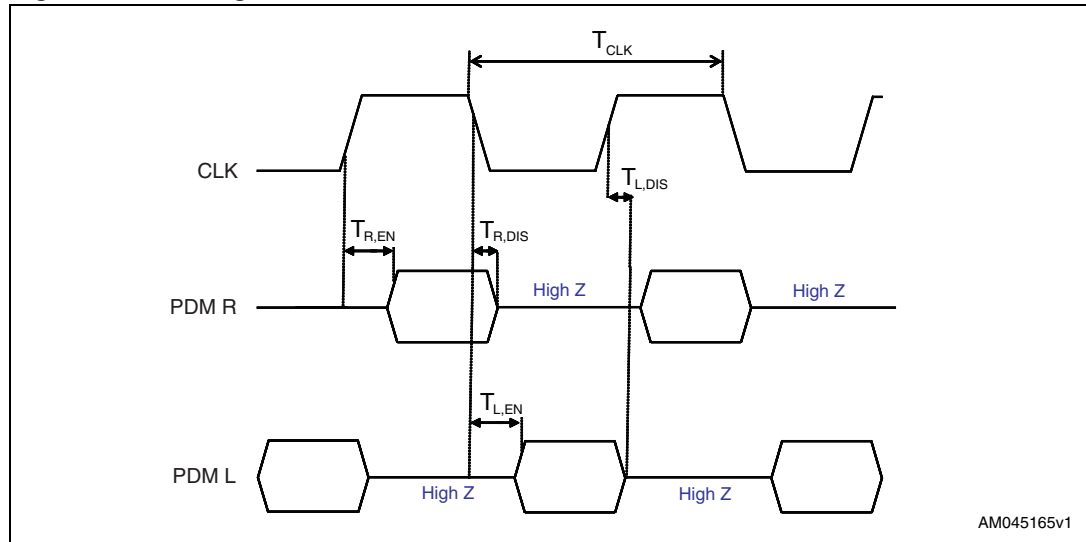

AM045165v1

## 2.3 Frequency response

Figure 3. Typical frequency response normalized at 1 kHz

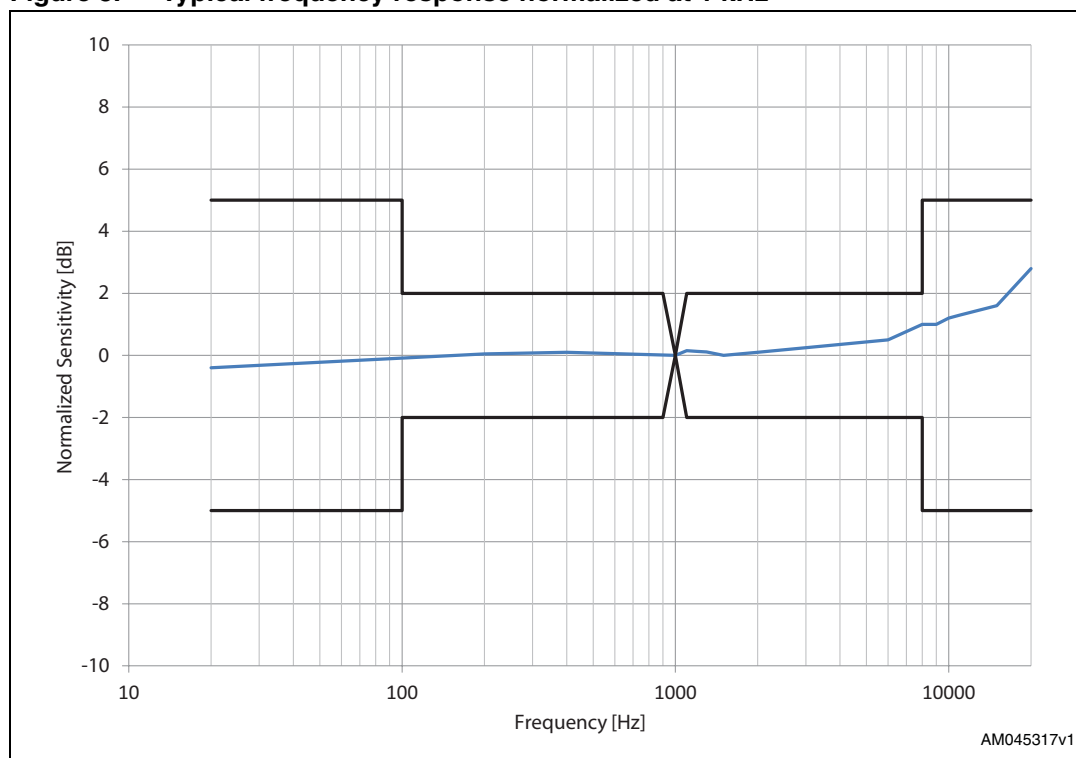

Table 6. Frequency response mask for digital microphones

Frequency / Hz <sup>(1)</sup>	Lower limit	Upper limit	Unit
20...100	-5	+5	dBr 1kHz
100...8000	-2	+2	dBr 1kHz
8000...20000	-5	+5	dBr 1kHz

1. At T = 20 °C and acoustic stimulus = 1 Pa (94 dB SPL).



### 3 Sensing element

The sensing element shall mean the acoustic sensor consisting of a conductive movable plate and a fixed plate placed in a tiny silicon chip. This sensor transduces the sound pressure into the changes of coupled capacity between those two plates.

Omron Corporation supplies this element for STMicroelectronics.

## 4 Absolute maximum ratings

Stresses above those listed as “absolute maximum ratings” may cause permanent damage to the device. This is a stress rating only and functional operation of the device under these conditions is not implied. Exposure to maximum rating conditions for extended periods may affect device reliability.

**Table 7. Absolute maximum ratings**

Symbol	Ratings	Maximum value	Unit
Vdd	Supply voltage	-0.3 to 6	V
Vin	Input voltage on any control pin	-0.3 to Vdd +0.3	V
T <sub>STG</sub>	Storage temperature range	-40 to +125	°C
ESD	Electrostatic discharge protection	2 (HBM)	kV

 This device is sensitive to mechanical shock, improper handling can cause permanent damage to the part.

 This device is ESD-sensitive, improper handling can cause permanent damage to the part.

## 5 Functionality

### 5.1 L/R channel selection

The L/R digital pad lets the user select the DOUT signal pattern as explained in [Table 8](#). The L/R pin must be connected to Vdd or GND.

**Table 8. L/R channel selection**

L/R	CLK low	CLK high
GND	Data valid	High impedance
Vdd	High impedance	Data valid

## 6 Application recommendations

Figure 4. MP34DB01 electrical connections

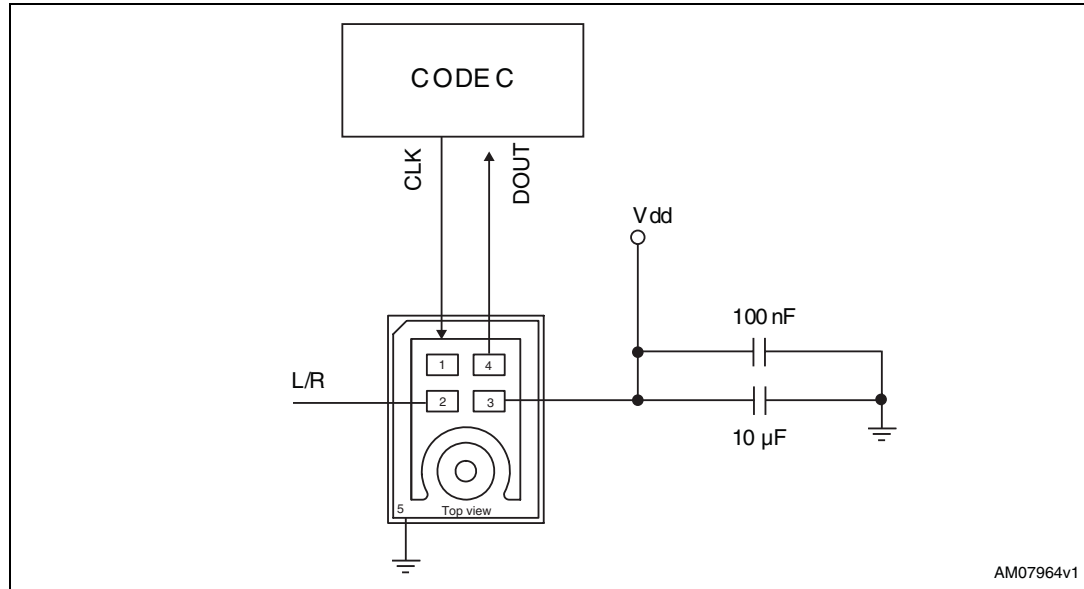

AM07964v1

Figure 5. MP34DB01 electrical connections for stereo configuration

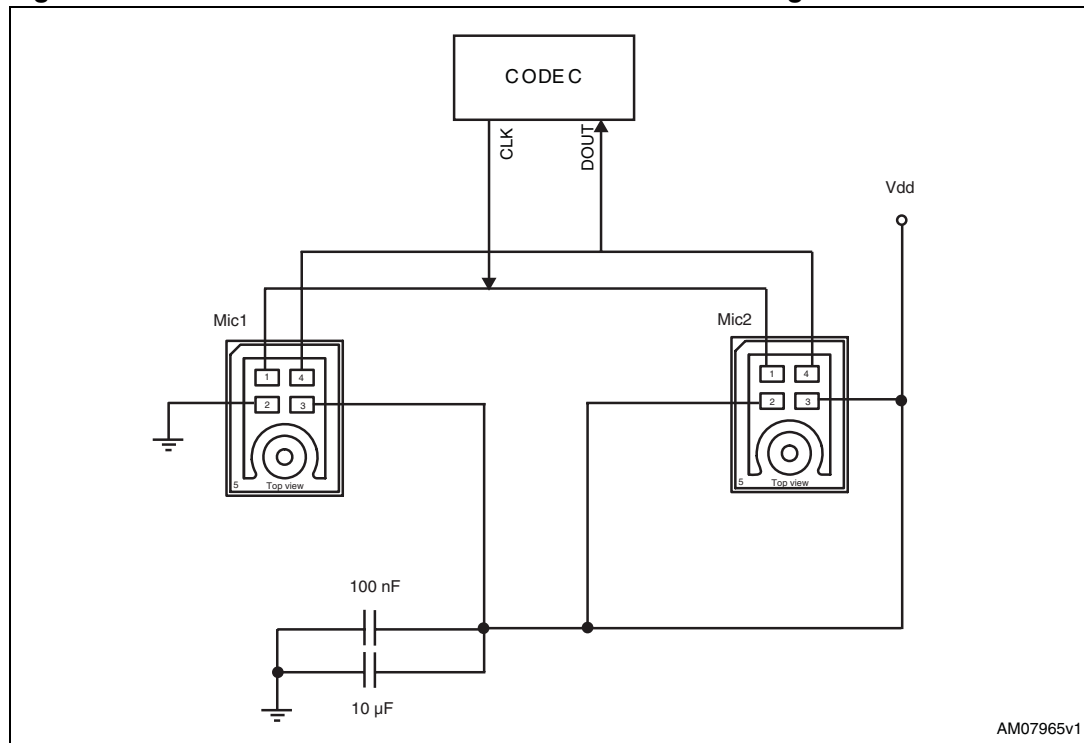

AM07965v1

Power supply decoupling capacitors (100 nF ceramic, 10 µF ceramic) should be placed as near as possible to pin 3 of the device (common design practice).

The L/R pin must be connected to Vdd or GND (refer to [Table 8](#)).

## 7 Package mechanical data

In order to meet environmental requirements, ST offers these devices in different grades of ECOPACK® packages, depending on their level of environmental compliance. ECOPACK® specifications, grade definitions and product status are available at: [www.st.com](http://www.st.com). ECOPACK is an ST trademark.

### Soldering information

The RHLGA (3 x 4 x 1) mm package is also compliant with the RoHS and “Green” standards and is qualified for soldering heat resistance according to JEDEC J-STD-020.

Landing pattern and soldering recommendations are available at [www.st.com](http://www.st.com).

**Figure 6. Recommended soldering profile limits**

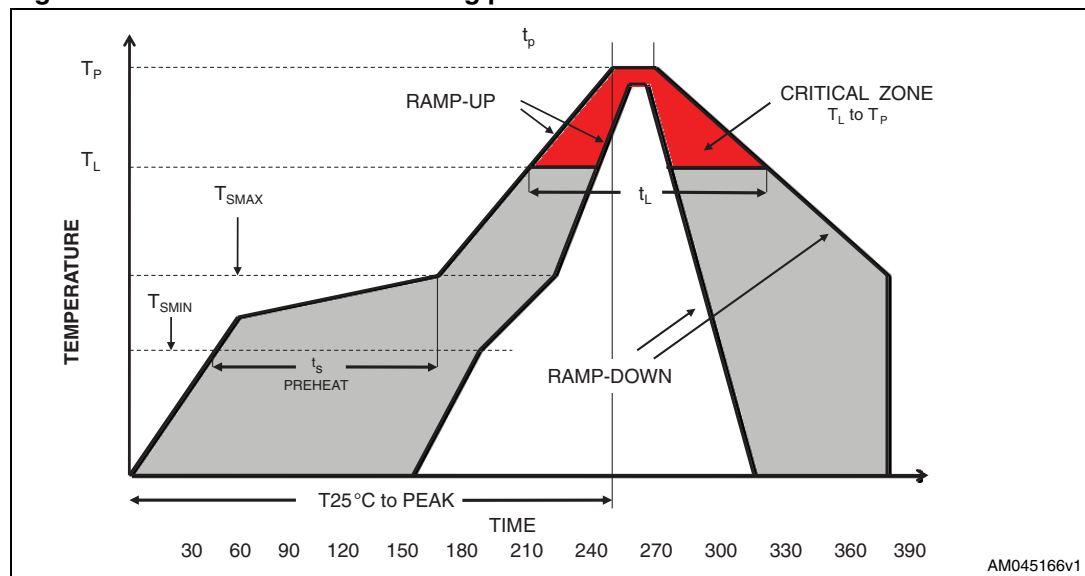

**Table 9. Recommended soldering profile limits**

Description	Parameter	Pb free
Average ramp rate	$T_L$ to $T_P$	3 °C/sec max
Preheat		
Minimum temperature	$T_{SMIN}$	150 °C
Maximum temperature	$T_{SMAX}$	200 °C
Time ( $T_{SMIN}$ to $T_{SMAX}$ )	$t_s$	60 sec to 120 sec
Ramp-up rate	$T_{SMAX}$ to $T_L$	
Time maintained above liquidous temperature	$t_L$	60 sec to 150 sec
Liquidous temperature	$T_L$	217 °C
Peak temperature	$T_P$	260 °C max
Time within 5 °C of actual peak temperature		20 sec to 40 sec
Ramp-down rate		6 °C/sec max
Time 25 °C ( $t_{25 °C}$ ) to peak temperature		8 minutes max

Figure 7. RHLGA 3 mm x 4 mm x 1 mm 4-lead package outline

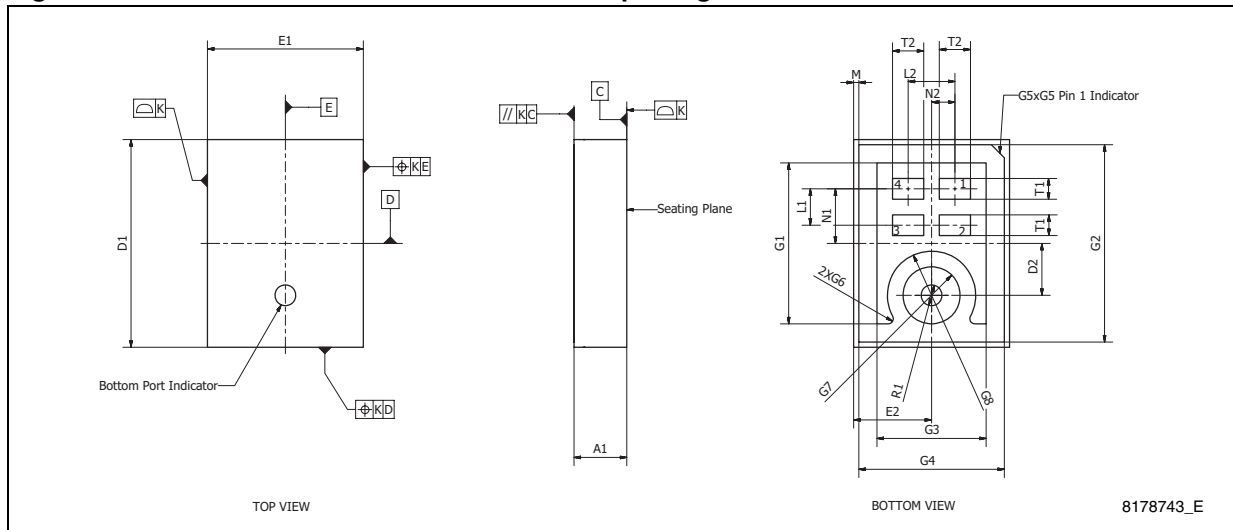

Table 10. RHLGA 3 mm x 4 mm x 1 mm 4-lead package dimensions

Symbol	mm		
	Min	Typ	Max
A1	0.900	1.000	1.100
D1	3.900	4.000	4.100
D2	0.950	1.000	1.050
R1	0.350	0.400	0.450
E1	2.900	3.000	3.100
E2	1.450	1.500	1.550
L1	0.650	0.700	0.750
L2	0.850	0.900	0.950
N1	1.000	1.050	1.100
N2	0.400	0.450	0.500
T1	0.350	0.400	0.450
T2	0.550	0.600	0.650
G1	3.050	3.100	3.150
G2	3.750	3.800	3.850
G3	2.050	2.100	2.150
G4	2.750	2.800	2.850
G5	0.250	0.300	0.350
G6	0.050	0.100	0.150
G7	0.500	0.550	0.600
G8	0.800	0.850	0.900
M		0.100	
K		0.050	

## 8 Revision history

**Table 11. Document revision history**

Date	Revision	Changes
28-Mar-2011	1	Initial release
05-Apr-2011	2	Updated <a href="#">Table 3</a> and <a href="#">Table 5</a>
21-Oct-2011	3	Added max. peak temperature $T_P$ to <a href="#">Table 9</a>
18-Nov-2011	4	Updated SNR typical value in <a href="#">Table 3</a> ; document promoted from preliminary to full datasheet
04-Jan-2012	5	Updated <a href="#">Features</a> and <a href="#">Description</a> Updated <a href="#">Figure 3: Typical frequency response normalized at 1 kHz</a>
20-Mar-2012	6	Added test condition criterion to PSR in <a href="#">Table 3: Acoustic and electrical characteristics</a>
07-May-2012	7	Added $V_{IOL}$ , $V_{IOH}$ to <a href="#">Table 3: Acoustic and electrical characteristics</a>
05-Jul-2012	8	Added <a href="#">Section 3: Sensing element</a> Updated operating temperature range throughout datasheet

**Please Read Carefully:**

Information in this document is provided solely in connection with ST products. STMicroelectronics NV and its subsidiaries ("ST") reserve the right to make changes, corrections, modifications or improvements, to this document, and the products and services described herein at any time, without notice.

All ST products are sold pursuant to ST's terms and conditions of sale.

Purchasers are solely responsible for the choice, selection and use of the ST products and services described herein, and ST assumes no liability whatsoever relating to the choice, selection or use of the ST products and services described herein.

No license, express or implied, by estoppel or otherwise, to any intellectual property rights is granted under this document. If any part of this document refers to any third party products or services it shall not be deemed a license grant by ST for the use of such third party products or services, or any intellectual property contained therein or considered as a warranty covering the use in any manner whatsoever of such third party products or services or any intellectual property contained therein.

**UNLESS OTHERWISE SET FORTH IN ST'S TERMS AND CONDITIONS OF SALE ST DISCLAIMS ANY EXPRESS OR IMPLIED WARRANTY WITH RESPECT TO THE USE AND/OR SALE OF ST PRODUCTS INCLUDING WITHOUT LIMITATION IMPLIED WARRANTIES OF MERCHANTABILITY, FITNESS FOR A PARTICULAR PURPOSE (AND THEIR EQUIVALENTS UNDER THE LAWS OF ANY JURISDICTION), OR INFRINGEMENT OF ANY PATENT, COPYRIGHT OR OTHER INTELLECTUAL PROPERTY RIGHT.**

**UNLESS EXPRESSLY APPROVED IN WRITING BY TWO AUTHORIZED ST REPRESENTATIVES, ST PRODUCTS ARE NOT RECOMMENDED, AUTHORIZED OR WARRANTED FOR USE IN MILITARY, AIR CRAFT, SPACE, LIFE SAVING, OR LIFE SUSTAINING APPLICATIONS, NOR IN PRODUCTS OR SYSTEMS WHERE FAILURE OR MALFUNCTION MAY RESULT IN PERSONAL INJURY, DEATH, OR SEVERE PROPERTY OR ENVIRONMENTAL DAMAGE. ST PRODUCTS WHICH ARE NOT SPECIFIED AS "AUTOMOTIVE GRADE" MAY ONLY BE USED IN AUTOMOTIVE APPLICATIONS AT USER'S OWN RISK.**

Resale of ST products with provisions different from the statements and/or technical features set forth in this document shall immediately void any warranty granted by ST for the ST product or service described herein and shall not create or extend in any manner whatsoever, any liability of ST.

ST and the ST logo are trademarks or registered trademarks of ST in various countries.

Information in this document supersedes and replaces all information previously supplied.

The ST logo is a registered trademark of STMicroelectronics. All other names are the property of their respective owners.

© 2012 STMicroelectronics - All rights reserved

STMicroelectronics group of companies

Australia - Belgium - Brazil - Canada - China - Czech Republic - Finland - France - Germany - Hong Kong - India - Israel - Italy - Japan - Malaysia - Malta - Morocco - Philippines - Singapore - Spain - Sweden - Switzerland - United Kingdom - United States of America

[www.st.com](http://www.st.com)