

Introduction

The STM32100B-EVAL is an evaluation board for STMicroelectronics ARM™ Cortex-M3 core-based STM32F100VBT6 microcontroller. It is designed as a complete development environment with HDMI CEC, two I²C channels, two SPI channels, three USART channels, 8 KB internal SRAM and 128 KB internal Flash, and JTAG and SWD debugging support.

With a complete range of hardware evaluations features, the STM32100B-EVAL board is designed to help developers evaluate all device peripherals (such as HDMI CEC, motor control, LCD, MicroSD Card™, serial Flash, speaker, IrDA and USART) and develop their own applications. Extension connectors make it possible to easily connect a daughterboard or wrapping board for a specific application.

An ST-LINK is integrated on the board as an embedded in-circuit debugger and programmer for the STM32F100VBT6 MCU.

Table 1 lists the development tools concerned by this user manual.

Table 1. Applicable tools

Type	Part number
Evaluation tool	STM32100B-EVAL

Figure 1. STM32F100VBT6 evaluation board (STM32100B-EVAL)

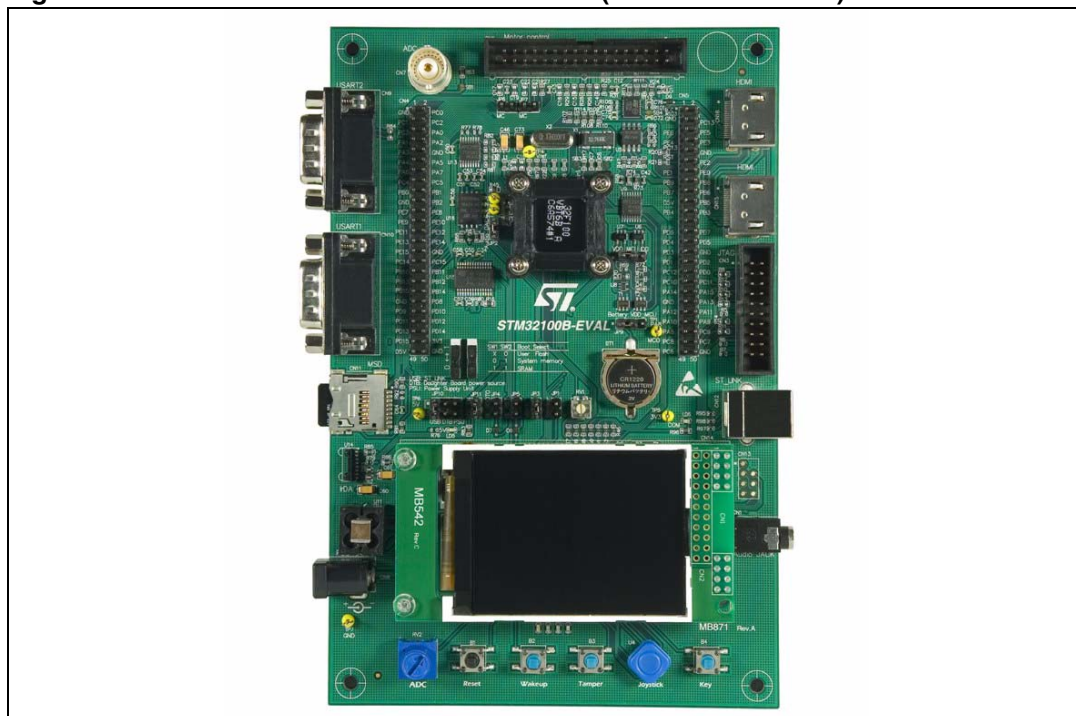

Contents

- 1 Overview 6**
 - 1.1 Features 6
 - 1.2 Demonstration software 6
 - 1.3 Order code 6

- 2 Hardware layout and configuration 7**
 - 2.1 Power supply 9
 - 2.2 Boot option 10
 - 2.3 Clock source 11
 - 2.4 Reset source 11
 - 2.5 Audio 12
 - 2.6 Serial Flash 12
 - 2.7 RS-232 12
 - 2.8 Motor control 12
 - 2.9 MicroSD Card 13
 - 2.10 Temperature sensor 13
 - 2.11 Development and debug support 13
 - 2.12 Analog input 13
 - 2.13 IrDA 14
 - 2.14 Display and input devices 14
 - 2.15 IDD measurement 15
 - 2.15.1 Run mode 15
 - 2.15.2 Low power mode 15
 - 2.15.3 Standby or Stop IDD measurement procedure 15
 - 2.15.4 Low IDD measurement improvement procedure 16
 - 2.16 HDMI CEC 16

- 3 Connectors 17**
 - 3.1 Audio jack CN1 17
 - 3.2 JTAG debugging connector CN3 17
 - 3.3 Daughterboard extension connectors CN4 and CN5 18
 - 3.4 Motor control connector CN6 22

3.5	Analog input connector CN7	23
3.6	Power supply connector CN8	23
3.7	RS-232 connector CN9 with RTS/CTS handshake support	24
3.8	RS-232 connector CN10 with ISP support	24
3.9	MicroSD connector CN11	25
3.10	ST-LINK connector CN12	25
3.11	ST-LINK programming connector CN13	26
3.12	HDMI connectors CN15 and CN16	26
4	Limitations	27
4.1	Boot switches	27
4.2	PE14, PB14 and PA10 usage	27
4.3	Jumper JP3	27
4.4	Audio amplifier volume	27
4.5	IDD standby measurement	27
5	Schematics	28
Appendix A STM32100B-EVAL I/O assignments		41
Revision history		44

List of tables

Table 1.	Applicable tools	1
Table 2.	Power jumpers	9
Table 3.	MCU power consumption measurement jumpers.	10
Table 4.	Boot switches and jumper.	11
Table 5.	Reset jumper	12
Table 6.	Audio jumpers	12
Table 7.	Motor control jumpers	13
Table 8.	IrDA jumper.	14
Table 9.	240x320 TFT color LCD modules	14
Table 10.	HDMI CEC solder bridge	16
Table 11.	JTAG debugging connector	17
Table 12.	Daughterboard extension connector CN4	18
Table 13.	Daughterboard extension connector CN5	20
Table 14.	Motor control connector CN6	22
Table 15.	Analog input connector CN7	23
Table 16.	RS-232 connector CN9 with full modem control support	24
Table 17.	RS-232 connector CN10.	24
Table 18.	MicroSD connector CN11	25
Table 19.	ST-LINK USB connector (CN12)	25
Table 20.	HDMI connectors (CN15 and CN16)	26
Table 21.	Missing resistors on PCB rev A	27
Table 22.	STM32100B-EVAL I/O assignments	41

List of figures

Figure 1.	STM32F100VBT6 evaluation board (STM32100B-EVAL)	1
Figure 2.	Hardware block diagram	7
Figure 3.	STM32100B-EVAL board layout	8
Figure 4.	STM32100B-EVAL IDD measurement circuit	15
Figure 5.	STM32100B-EVAL IDD low power mode measurement timing diagram	16
Figure 6.	JTAG debugging connector CN3 (front view)	17
Figure 7.	Motor control connector CN6 (top view)	22
Figure 8.	Analog input connector CN7 (bottom view)	23
Figure 9.	Power supply connector CN8 (front view)	23
Figure 10.	RS-232 connector CN9 with RTS/CTS handshake support (front view)	24
Figure 11.	RS-232 connector CN10 (front view)	24
Figure 12.	MicroSD connector CN11 (top view)	25
Figure 13.	ST-LINK connector CN12 (front view)	25
Figure 14.	HDMI connectors CN15 and CN16	26
Figure 15.	Evaluation board schematics	29
Figure 16.	MCU	30
Figure 17.	Peripherals	31
Figure 18.	RS-232	32
Figure 19.	Audio	33
Figure 20.	Joystick, LCD, tamper button, wakeup button, user button	34
Figure 21.	MicroSD Card and Flash	35
Figure 22.	Motor control	36
Figure 23.	JTAG and SWD debugger	37
Figure 24.	Power supply	38
Figure 25.	ST-LINK	39
Figure 26.	2.4 inch color LCD board	40

1 Overview

1.1 Features

- Three 5 V power supply options: power jack, ST-LINK connector or daughterboard
- Boot from user Flash, system memory or SRAM
- Speaker
- 1 Gbyte MicroSD Card™
- 16 Mbyte serial Flash
- I²C/SMBus compatible serial interface temperature sensor
- Two RS-232 communication channels with support for RTS/CTS handshake on one channel
- IrDA transceiver
- Induction motor control connector
- JTAG and SWD debug support
- 240x320 TFT color LCD
- Joystick with 4-direction control and selector
- Reset, wakeup, tamper and user push buttons
- Four LEDs
- RTC with backup battery
- Extension connector for daughterboard or wrapping board
- Embedded ST-LINK
- IDD current measurement circuit
- HDMI CEC

1.2 Demonstration software

Demonstration software is preloaded in the board's Flash memory for easy demonstration of the device peripherals in stand-alone mode. For more information and to download the latest version available, please refer to the STM32100B-EVAL demonstration software available on www.st.com.

1.3 Order code

To order the STM32F100VBT6 evaluation board, use the order code STM32100B-EVAL.

2 Hardware layout and configuration

The STM32100B-EVAL board is designed around a STM32F100VBT6 microcontroller in a 100-pin LQFP package.

The hardware block diagram *Figure 2* shows the connections between the STM32F100VBT6 microcontroller and the peripherals (LCD, SPI Flash, USART, IrDA, speaker, HDMI CEC, temperature sensor, MicroSD Card, motor control and embedded ST-LINK).

Figure 3 will help you locate these features on the evaluation board.

Figure 2. Hardware block diagram

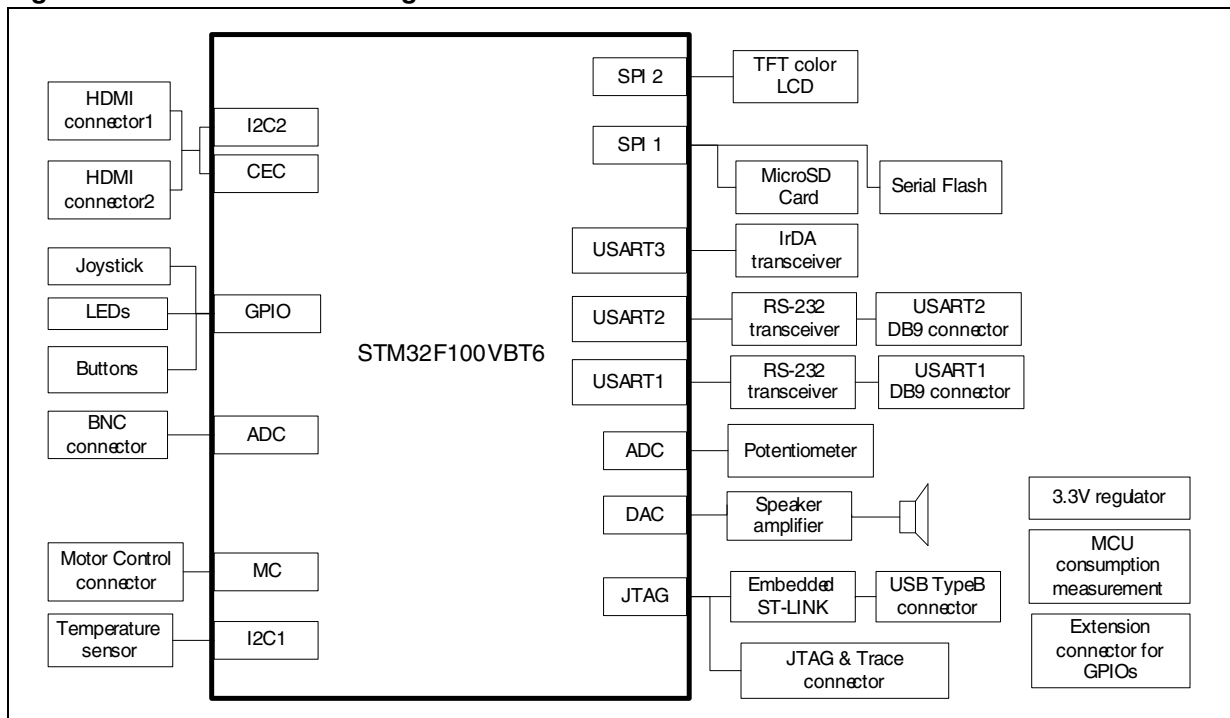

2.1 Power supply





The STM32100B-EVAL board is designed to be powered by a 5 V DC power supply and to be protected by PolyZen U10 in case of incorrect power supply configuration.

It is possible to configure the evaluation board to use any of the following sources for the power supply:

- 5 V DC power adapter connected to CN8, the power supply jack labeled “PSU” (for power supply unit) on the silkscreen.
- 5 V DC power with 500 mA limitation from CN12, the ST-LINK type-B USB connector labeled “USB” on the silkscreen.
- 5 V DC power from both CN4 and CN5, the daughterboard extension connectors labeled “DTB” (for daughterboard) on the silkscreen.

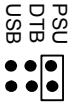
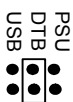
The power supply is configured by setting jumpers **JP9** and **JP10** as described in [Table 2](#).

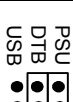
Table 2. Power jumpers

Jumper	Description
JP10	JP10 is used to select one of the three possible power supply resources. For power supply from the power supply jack (CN8) to the STM32100B-EVAL <u>only</u> , JP10 is set as shown: <div style="float: right; text-align: right;">  <p>PSU DTB USB</p> </div>
	For power supply from the daughterboard connectors (CN4 and CN5) to the STM32100B-EVAL <u>only</u> , JP10 is set as shown: <div style="float: right; text-align: right;">  <p>PSU DTB USB</p> </div>
	For power supply from the ST-LINK USB connector (CN12) to the STM32100B-EVAL <u>only</u> , JP10 is set as shown (default setting): <div style="float: right; text-align: right;">  <p>PSU DTB USB</p> </div>
	For power supply from power supply jack (CN8) to both the STM32100B-EVAL board and to a daughterboard connected on CN4 and CN5, JP10 is set as shown: The daughterboard must not have its own power supply connected. <div style="float: right; text-align: right;">  <p>PSU DTB USB</p> </div>
JP9	V _{bat} is connected to VDD_MCU power when JP9 is set as shown (default setting): <div style="float: right; text-align: right;">  <p>1 2 3</p> </div>
	V _{bat} is connected to battery when JP9 is set as shown: <div style="float: right; text-align: right;">  <p>1 2 3</p> </div>

Caution: Risk of explosion if battery is replaced by an incorrect one. Dispose of used batteries according to the instructions.

To enable MCU power consumption measurement, JP8 and JP12 should be re-configured as described in [Table 3](#). (PCB rev B only. See [Section 4.5: IDD standby measurement](#) for details.)

LED LD5 is lit when the STM32100B-EVAL board is correctly powered by 5 V.

Note: The AC220V to DC5V power adapter PSU-5V2A (recommended and can be ordered from ST, it is not provided with board by default) or equivalent power adapter (polarity compatible with CN8) can be used to power STM32100B-EVAL board via power jack CN8 on the board. To order the recommended power supply, use the order code PSU-5C2A.

Table 3. MCU power consumption measurement jumpers

Jumper	Description
JP8	VDD power is directly connected to MCU VDD when JP8 is set as shown: (Default setting) Note: For manual IDD measurement JP8 must be removed and replaced by an ammeter connected between JP8 pins 1 and 2.
	Connect VDD power to MCU with current-sampling resistor, 1Ω or 1KΩ, in series for IDD current measurement when JP8 is set as shown:
JP12	(Available only on PCB rev B.) Connect IDD_CNT_EN (PE14) to Anti-tamper (PC13) for IDD current measurement in standby mode when JP12 is closed. Default setting: Not fitted

2.2 Boot option

The STM32100B-EVAL board can boot from:

- Embedded user Flash
- System memory with boot loader for ISP
- Embedded SRAM for debugging

The boot option is configured by switches SW1 and SW2 as shown in [Table 4](#).

Note: The hardware implementation of JP4 and the RS-232 interface can be only used when the Boot0 is at a high level through the onboard switch SW2, which is not the most common case of usage.

Table 4. Boot switches and jumper

Switch	Boot from	Switch configuration
SW1 SW2	STM32100B-EVAL boots from user Flash when SW2 is set as shown to the right (default setting). In this configuration, the position of SW1 does not affect the boot process.	
	STM32100B-EVAL boots from embedded SRAM when SW1 and SW2 are set as shown to the right.	
	STM32100B-EVAL boots from system memory when SW1 and SW2 are set as shown to the right.	
JP4	BOOT0 pin of the STM32F100VBT6 is connected to the RS-232 connector CN10 pin 8 (CTS) for ISP support when JP4 is closed. This configuration is used for boot loader application only. Default setting: not fitted.	

2.3 Clock source

Two clock sources are available on the STM32100B-EVAL board for the STM32F100VBT6 microcontroller and RTC.

- X1, 32 KHz crystal for embedded RTC
- X2, 8 MHz crystal with socket for the STM32F100VBT6 microcontroller. It can be removed from the socket when the internal RC clock is used.

2.4 Reset source

The reset signal of the STM32100B-EVAL board is active low and the reset sources include:

- Reset button B1
- Debugging tools from JTAG connector CN3
- Daughterboard from CN5
- Embedded ST-LINK
- Bootloader_Reset from RS-232 connector CN10

Table 5. Reset jumper

Jumper	Description
JP5	Bootloader_Reset signal from the RS-232 connector CN10 pin 1 (DCD) is connected to RESET# of the STM32F100VBT6 when JP5 is closed. This configuration is used for the boot loader application only. Default setting: Not fitted

2.5 Audio

The STM32100B-EVAL board supports playback based on a speaker on the board. This can be disabled or enabled by jumpers JP1 and JP2. The audio volume can be adjusted using the potentiometer RV1. See [Section 4.4: Audio amplifier volume](#).

Table 6. Audio jumpers

Jumper	Description
JP1	Audio power amplifier TS4990IST is forced on standby mode when JP1 is fitted. Default setting: Not fitted
JP2	The DAC _OUT(PA4) is connected to speaker circuit when JP2 is closed. Default setting: Fitted

2.6 Serial Flash

A 128 Mbit serial Flash connected to SPI1 of the STM32F100VBT6 microcontroller shares the same SPI port with the MicroSD Card using a different chip select signal. Serial Flash chip select is managed by the standard I/O port PD9.

2.7 RS-232

Two type D 9-pin connectors, CN10 (USART1) and CN9 (USART2) are available on the STM32100B-EVAL board.

- CN10 connects to the RS-232 transceiver U15 with Bootloader_Reset and Bootloader_BOOT0 support.
- CN9 connects to the RS-232 transceiver U13 with RTS/CTS handshake signal support.

2.8 Motor control

The STM32100B-EVAL board supports induction motor control via a 34-pin connector, CN6, which provides all required control and feedback signals to and from a motor power-drive board. Available signals on this connector include emergency stop, motor speed, 3-phase motor current, bus voltage, heat sink temperature coming from the motor drive board and 6 channels of PWM control signals going to the motor drive circuit.

Special motor current sampling operation is enabled by setting jumper JP7.

Note: On MB871 PCB rev A MC_CurrentA shares PC1 with VBAT_ADCIN through JP3 so the jumper JP3 must be removed for motor control applications. See [Section 4.3: Jumper JP3](#).

Table 7. Motor control jumpers

Jumper	Description
JP7	The special motor current sampling operation is enabled when JP7 is fitted (PD2 connected to PB0). The I/O pins PD2 and PB0 are disconnected and can be used by daughterboard when JP7 is not fitted. Default setting: Not fitted
JP6	JP6 should be kept open when encoder signal is from pin 31 of motor control connector CN6. It should be kept closed when analog signal is from pin 31 of CN6 for special motor. Default setting: Not fitted (open)

2.9 MicroSD Card

The 1 Gbyte MicroSD Card connected to SPI1 of the STM32F100VBT6 microcontroller (shared with serial Flash), is available on the board. MicroSD Card chip selection is managed by the standard I/O port PC12 while the MicroSD card defect signal is managed by I/O port PE7.

2.10 Temperature sensor

One I²C interface temperature sensor STLM75 (–55°C to +125°C) connected to I²C1 of the STM32F10x microcontroller, is available on the board.

2.11 Development and debug support

An embedded ST-LINK STM32 JTAG interface developed by STMicroelectronics is available on the STM32100B-EVAL as the default debugger hardware interface.

Of course, third-party debugger interfaces are also supported by the JTAG connector CN3.

2.12 Analog input

One BNC connector, CN7, is connected to PA4 of the STM32F100VBT6 microcontroller as an external analog input. or DAC output. The 50Ω terminal resistor can be enabled by closing solder bridge SB1. A low pass filter can be implemented for the BNC connector by replacing R44 and C33 for ADC input, or replacing R43 and C33 for DAC output with the correct value of resistor and capacitor as requested by the end user's application.

There are also 3 analog signals available on the board:

1. 10 KΩ potentiometer RV2 connected to PC4.
2. IDD measurement output signal connected to PC5 for MCU power consumption test.
3. External ADC input which can be connected to TP3 (AIN+) and TP2 (AIN-), R45 should be removed to avoid noise.

2.13 IrDA

IrDA communication is supported by the IrDA transceiver U14, which is connected to USART3 of the STM32F100VBT6 microcontroller. It is enabled or disabled by jumper JP11.

Table 8. IrDA jumper

Jumper	Description
JP11	Enables/disables the IrDA transceiver. IrDA is enabled when JP11 is fitted, and disabled when JP11 is not fitted. Default setting: Fitted

2.14 Display and input devices

The 240x320 TFT color LCD (mounted on connector CN14) and 4 general purpose LEDs (LD1, 2, 3, 4) are available as display devices.

A 4-direction joystick with selection key, general purpose push button (B4), wakeup button (B2) and tamper detection button (B3) are available as input devices.

Table 9. 240x320 TFT color LCD modules

CN14 pin	Description	Pin connection	CN14 pin	Description	Pin connection
1	CS	PB2	9	VDD	+3V3
2	SCL	PB13	10	VCI	+3V3
3	SDI	PB15	11	GND	GND
4	RS		12	GND	GND
5	WR		13	BL_VDD	+3V3
6	RD		14	BL_Control	PA8
7	SDO	PB14	15	BL_GND	GND
8	RESET#	RESET#	16	BL_GND	GND

2.15 IDD measurement

For IDD measurement the circuit below is implemented on the STM32100B-EVAL.

Figure 4. STM32100B-EVAL IDD measurement circuit

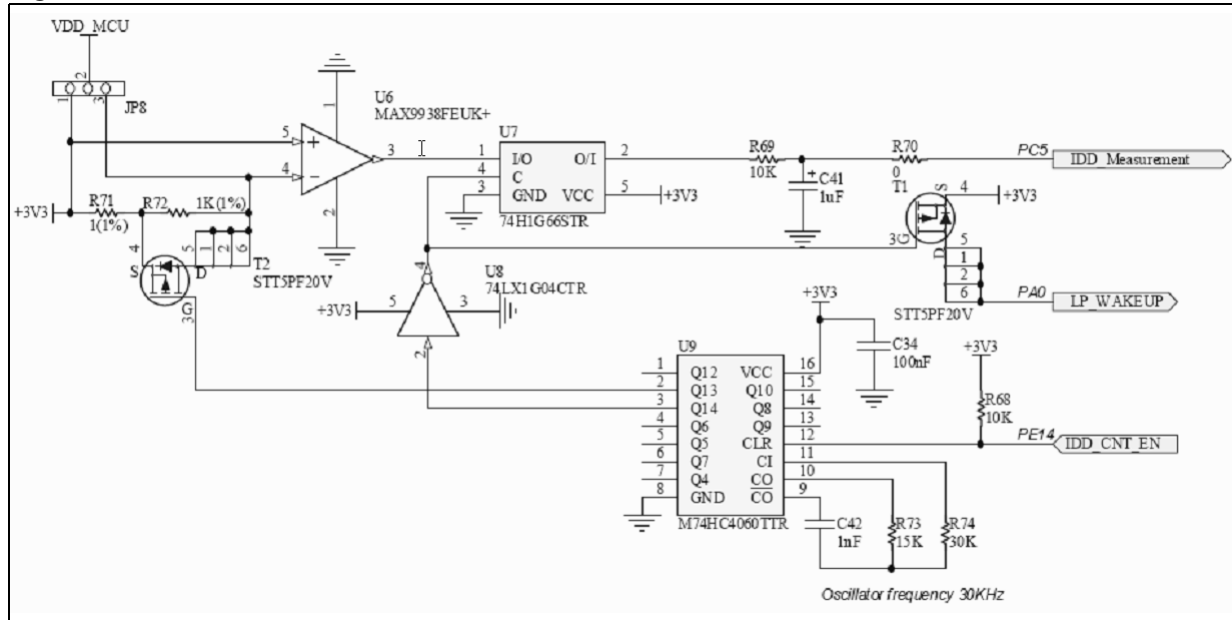

2.15.1 Run mode

In Run mode, IDD current is measured using MAX9938FEUK+ (U6) connected to the 1Ω shunt resistor (R71). In this case IDD_CNT_EN remains high during measurement and a jumper must be connected between pins 2 and 3 of JP8.

2.15.2 Low power mode

In low power modes (Stop or Standby), the operational amplifier MAX9938FEUK+ (U6) is connected to the 1KΩ shunt resistor (R72), controlled by the analogue switch STT5PF20V (T2). In this case the counter 74HC4060 (U9) enabled by IDD_CNT_EN manages the measurement timing according to [Figure 5](#).

2.15.3 Standby or Stop IDD measurement procedure

To measure a current corresponding to the low power mode the procedure is:

1. Configure ADC to measure voltage on IDD_measurement pin.
2. Configure PA0 as wakeup pin.
3. Enter in Low Power mode after configuring IDD_CNT_EN Low as output low level (PC13 if JP12 is closed, or PE14 if JP12 is open or on MB871 rev A).
4. LP_WAKEUP rising edge wakeup the MCU after around 150 ms.
5. Start ADC conversion as soon as possible after wakeup in order to measure the voltage corresponding to Low Power mode on capacitor C41.
6. Reset the counter by programming IDD_CNT_EN High in less than 70 ms after the wakeup to avoid 1 KΩ being connected later on VDD_MCU.

In low power mode, the 1 KΩ resistor is connected when T2 goes off after entering low power mode. Q13 output of the counter allows connection of the 1KΩ resistor when the current IDD becomes very low. The measurement timing is given in *Figure 5*.

Figure 5. STM32100B-EVAL IDD low power mode measurement timing diagram

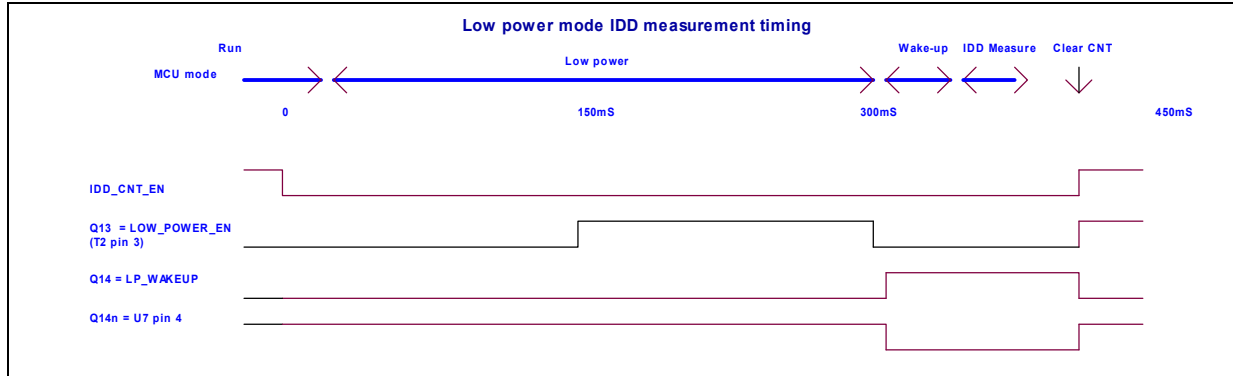

The low power mode measurement procedure can be used in Standby or Stop mode if the IDD current does not exceed 60 uA, otherwise the Run mode measurement procedure should be used up to 60 mA.

- Note:*
- 1 The standby current measure is not possible on MB871 rev A as explained in chapter 3.5 IDD standby measure.
 - 2 In standby mode the bias current of operational amplifier input (U6 pin 4) is not negligible compared to IDD current (Typical I bias is ~200 nA). To improve the IDD measurement precision it mandatory to subtract the I bias current to the IDD standby measure since this current is not sink by the MCU. It is possible to measure I bias (U1 pin 4 current) and to subtract this value to MCU current.

2.15.4 Low IDD measurement improvement procedure

The procedure for precision IDD measurement is:

1. Place a jumper on JP8 pins 1 and 2.
2. Follow the low power mode procedure to measure I1 = I bias.
3. Remove jumper JP8 pins 1 and 2 and place it on JP8 pins 2 and 3.
4. Follow the low power mode procedure to measure I2 = IDD + I bias.
5. Calculate actual IDD: $IDD = I2 - I1$.

2.16 HDMI CEC

Two HDMI connectors CN15 and CN16 are available on the STM32100B-EVAL board. The signals CEC, SCL, SDA and HPD are supported and connected to the STM32F100VBT6 through HDMI2C1-5DIJ, the ST full integrated ESD protection, level-shifting device and signal booster for control links of the HDMI 1.3 transmitter.

Table 10. HDMI CEC solder bridge

Jumper	Description
SB4	The +5 V power pin of HDMI connectors CN15 and CN16 is connected to 5 V power on the STM32100B-EVAL board when SB4 is closed. Default status: Open

3 Connectors

3.1 Audio jack CN1

A 3.5 mm mono audio jack CN1 is available on the STM32100B-EVAL board. The speaker U12 is bypassed when earphones are plugged into CN8.

3.2 JTAG debugging connector CN3

Figure 6. JTAG debugging connector CN3 (front view)

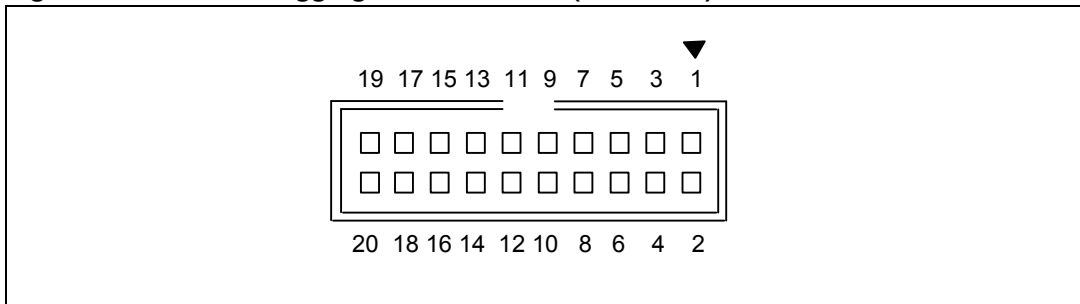

Table 11. JTAG debugging connector

Pin number	Description	Pin number	Description
1	3.3V power	2	3.3V power
3	TRST	4	GND
5	TDI	6	GND
7	TMS/SWDIO	8	GND
9	TCK/SWCLK	10	GND
11	RTCK	12	GND
13	TDO/SWO	14	GND
15	RESET#	16	GND
17	Pull-Down	18	GND
19	Pull-Down	20	GND

3.3 Daughterboard extension connectors CN4 and CN5

Two 50-pin male headers, CN4 and CN5, can connect a daughterboard or standard wrapping board to the STM32100B-EVAL board. All GPIOs are available on these connectors. The space between these two connectors and position of power, GND and RESET pin is defined as a standard (which allows to develop common daughterboards for several evaluation boards). Moreover all I/O on these connectors are pinout compatible with the STM3210B-EVAL board (except PC14 and PC15 which do not exist on the STM32F103VBT6). The standard width between CN4 pin1 and CN5 pin1 is 2700 mils (68.58mm). The standard was implemented on the majority of evaluation boards. Each pin on CN4 and CN5 can be used by a daughterboard after disconnecting it from the corresponding function block on the STM32100B-EVAL board. Refer to [Table 12](#) and [Table 13](#) for details.

Table 12. Daughterboard extension connector CN4

Pin	Description	Alternate function	How to disconnect from function block on STM32100B-EVAL board
1	GND	-	-
3	PC1	MC connector pin15	Disconnect STM32100B-EVAL evaluation board from motor power drive board
5	PC3	MC connector pin 19	Disconnect STM32100B-EVAL evaluation board from motor power drive board
7	PA1	MC connector pin 33	Disconnect STM32100B-EVAL evaluation board from motor power drive board
9	PA3	MC connector pin 14	Disconnect STM32100B-EVAL evaluation board from motor power drive board
11	PA4	Audio_DAC / BNC	Keep JP2 on open
13	PA6	SPI Flash& MicroSD card	Remove R89
15	PC4	Potentiometer RV2	Remove R48
17	PB0	MC connector pin 27	Keep JP7 on open
19	GND	-	-
21	PE7	MicroSD card detect	Remove card from CN11 or remove R91
23	PE9	MC connector pin 3	Disconnect STM32100B-EVAL evaluation board from motor power drive board
25	PE11	MC connector pin 7	Disconnect STM32100B-EVAL evaluation board from motor power drive board
27	PE13	MC connector pin 11	Disconnect STM32100B-EVAL evaluation board from motor power drive board
29	PE15	MC connector pin 1	Remove R24
31	PC14	OSC32_IN	Keep SB2 on close and remove R17
33	PB10	HDMI_SCL	Remove R108
35	PB13	LCD_CLK	-
37	PB15	LCD_MOSI	-
39	GND	-	-

Table 12. Daughterboard extension connector CN4 (continued)

Pin	Description	Alternate function	How to disconnect from function block on STM32100B-EVAL board
41	PD9	Flash_CS	-
43	PD11	-	-
45	PD13	MC connector pin 23	Disconnect STM32100B-EVAL evaluation board from motor power drive board
47	PD15	-	-
49	D5V	-	-
2	PC0	MC connector pin 26	Disconnect STM32100B-EVAL evaluation board from motor power drive board
4	PC2	MC connector pin 17	Disconnect STM32100B-EVAL evaluation board from motor power drive board
6	PA0	MC connector pin 31 & Wakeup button	Disconnect STM32100B-EVAL evaluation board from motor power drive board. Remove R58
8	PA2	MC connector pin 34	Disconnect STM32100B-EVAL evaluation board from motor power drive board
10	GND	-	-
12	PA5	SPI Flash & MicroSD card	-
14	PA7	SPI Flash & MicroSD card	-
16	PC5	IDD_measurement	Remove R70
18	PB1	MC connector pin 29	Disconnect STM32100B-EVAL evaluation board from motor power drive board
20	PB2	BOOT1 & LCD	-
22	PE8	MC connector pin 5	Disconnect STM32100B-EVAL evaluation board from motor power drive board
24	PE10	MC connector pin 9	Disconnect STM32100B-EVAL evaluation board from motor power drive board
26	PE12	MC connector pin 13	Disconnect STM32100B-EVAL evaluation board from motor power drive board
28	PE14	IDD_CNT_EN	Remove R117 (does not exist on PCB rev A)
30	GND	-	-
32	PC15	OSC32_OUT	Keep SB3 on close and remove R17
34	PB11	HDMI_SDA	Remove R109
36	PB12	HDMI_HPD	Remove R110
38	PB14	LCD_MISO	Remove R116 (does not exist on PCB rev A)
40	PD8	Joystick Up	Remove R42
42	PD10	MC connector pin 21	Disconnect STM32100B-EVAL evaluation board from motor power drive board
44	PD12	Joystick selection	Remove R38

Table 12. Daughterboard extension connector CN4 (continued)

Pin	Description	Alternate function	How to disconnect from function block on STM32100B-EVAL board
46	PD14	Joystick Down	Remove R39
48	+3V3	-	-
50	GND	-	-

Table 13. Daughterboard extension connector CN5

Pin	Description	Alternate function	How to disconnect from component on STM32100B-EVAL board
1	GND	-	-
3	NC	-	-
5	PE6	-	-
7	PE4	-	-
9	PC13	Tamper Key	Remove R37
11	RESET#	RESET# button	-
13	PE1	Joystick Right	Remove R41
15	PB9	User button	Remove R46
17	PB7	Temperature sensor_SDA	Remove R47
19	D5V	-	-
21	PB4	Debug nTRST	-
23	NC	-	-
25	PD6	USART2_RX	Remove R81
27	PD4	USART2_RTS	Remove R15
29	PD3	USART2_CTS	Remove R82
31	PD1	-	-
33	PC12	MicroSD card_CS	Remove R90
35	PC10	IrDA_TX	-
37	PA14	Debug TCK/SWCLK	-
39	GND	-	-
41	PA12	-	-
43	PA10	USART1_RX	Remove R115 (not existent on PCB rev A)
45	PA8	MCO	-
47	PC8	LED3	Remove R61
49	PC6	LED1	Remove R59
2	NC	-	-
4	PC13	Tamper button	Remove R637

Table 13. Daughterboard extension connector CN5 (continued)

Pin	Description	Alternate function	How to disconnect from component on STM32100B-EVAL board
6	PE5	-	-
8	PE3	-	-
10	GND	-	-
12	PE2	-	-
14	PE0	Joystick Left	Remove R40
16	PB8	HDMI_CEC	Remove R107
18	PB6	Temperature sensor_SCL	Remove R49
20	PB5	Temperature sensor_INT	Remove R50
22	PB3	Debug TDO/SWO	-
24	NC	-	-
26	PD7	-	-
28	PD5	USART2	Remove R9
30	GND	-	-
32	PD2	MC connector pin 27	Disconnect STM32100B-EVAL evaluation board from motor power drive board. Keep JP7 on open
34	PD0	-	-
36	PC11	IrDA_RX	Remove R83
38	PA15	Debug TDI	-
40	PA13	Debug TMS/SWDIO	-
42	PA11	LCD_Backlight	-
44	PA9	USART1_TX	Remove R16
46	PC9	LED4	Remove R62
48	PC7	LED2	Remove R60
50	GND	-	-

3.4 Motor control connector CN6

Figure 7. Motor control connector CN6 (top view)

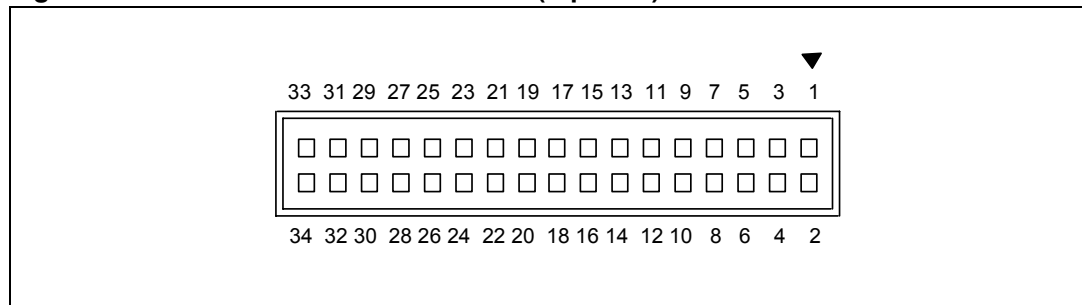

Table 14. Motor control connector CN6

Description	STM32F100VBT6 pin	CN6 pin		STM32F100VBT6 pin	Description
Emergency stop	PE15	1	2		GND
PWM-UH	PE9	3	4		GND
PWM-UL	PE8	5	6		GND
PWM-VH	PE11	7	8		GND
PWM-VL	PE10	9	10		GND
PWM-WH	PE13	11	12		GND
PWM-WL	PE12	13	14	PA3	Bus voltage
PHASE A current	PC1	15	16		GND
PHASE B current	PC2	17	18		GND
PHASE C current	PC3	19	20		GND
NTC bypass relay	PD10	21	22		GND
Dissipative brake PWM	PD13	23	24		GND
+5 V power		25	26	PC0	Heatsink temperature
PFC SYNC	PD2/PB0	27	28		3.3 V power
PFC PWM	PB1	29	30		GND
Encoder A	PA0	31	32		GND
Encoder B	PA1	33	34	PA2	Encoder index

3.5 Analog input connector CN7

Figure 8. Analog input connector CN7 (bottom view)

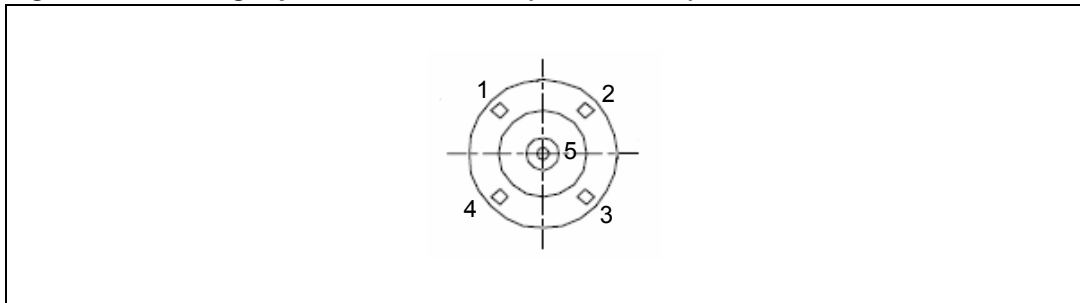

Table 15. Analog input connector CN7

Pin number	Description	Pin number	Description
1	GND	4	GND
2	GND	5	Analog input/PA4
3	GND		

3.6 Power supply connector CN8

The STM32100B-EVAL board can be powered from a DC 5 V power supply via the external power supply jack (CN8) shown in [Figure 9](#). The central pin of CN8 must be positive.

Figure 9. Power supply connector CN8 (front view)

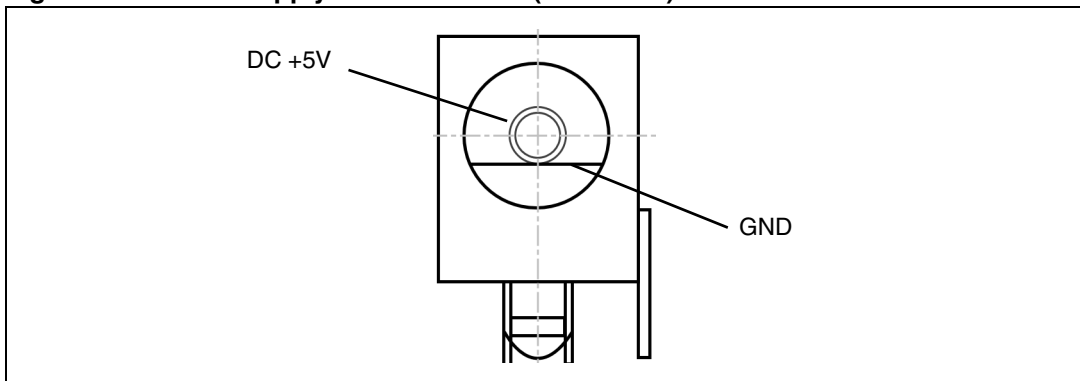

3.7 RS-232 connector CN9 with RTS/CTS handshake support

Figure 10. RS-232 connector CN9 with RTS/CTS handshake support (front view)

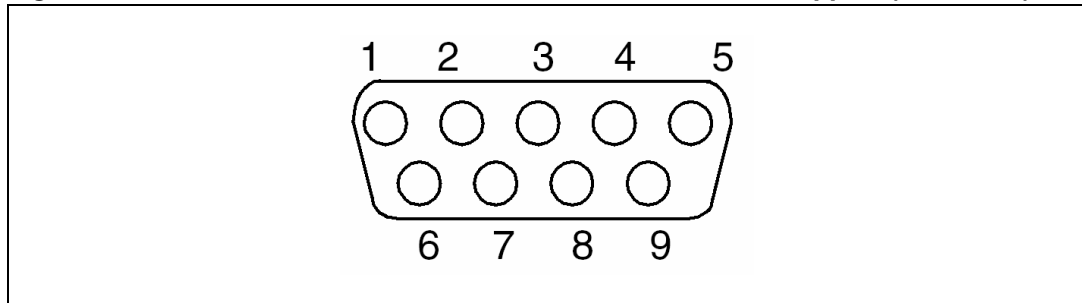

Table 16. RS-232 connector CN9 with full modem control support

Pin number	Description	Pin number	Description
1	NC	6	Connect to Pin 4
2	USART2_RX	7	USART2_RTS
3	USART2_TX	8	USART2_CTS
4	Connect to Pin 6	9	NC
5	GND		

3.8 RS-232 connector CN10 with ISP support

Figure 11. RS-232 connector CN10 (front view)

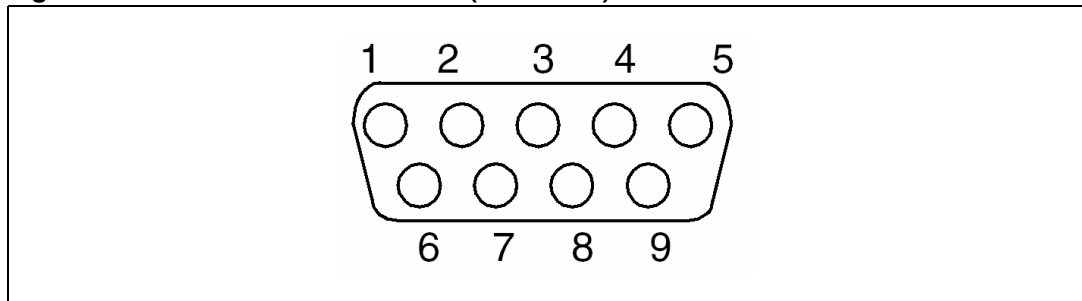

Table 17. RS-232 connector CN10

Pin number	Description	Pin number	Description
1	Bootloader_Reset	6	NC
2	USART1_RX	7	NC
3	USART1_TX	8	Bootloader_BOOT0
4	NC	9	NC
5	GND		

3.9 MicroSD connector CN11

Figure 12. MicroSD connector CN11 (top view)

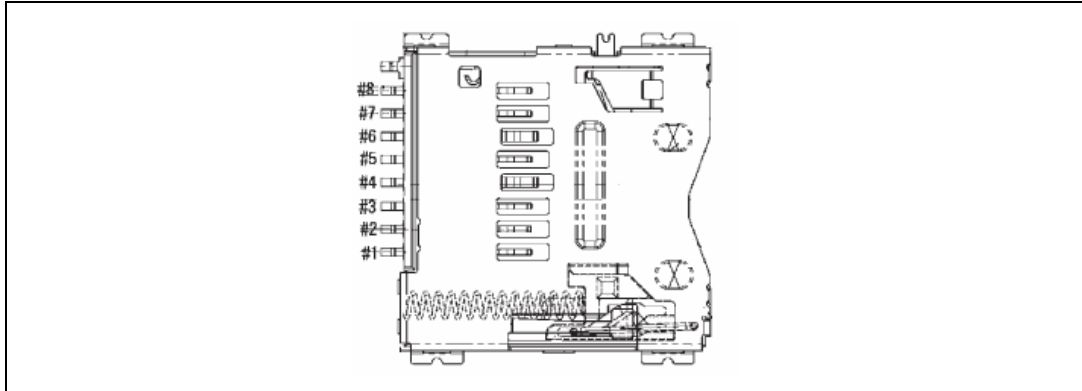

Table 18. MicroSD connector CN11

Pin number	Description	Pin number	Description
1	Reserved	5	SCLK/PA5
2	CS/PC12	6	Vss/GND
3	DI/PA7	7	DO/PA6
4	VDD	8, 9	Card detect (PE7)

3.10 ST-LINK connector CN12

Figure 13. ST-LINK connector CN12 (front view)

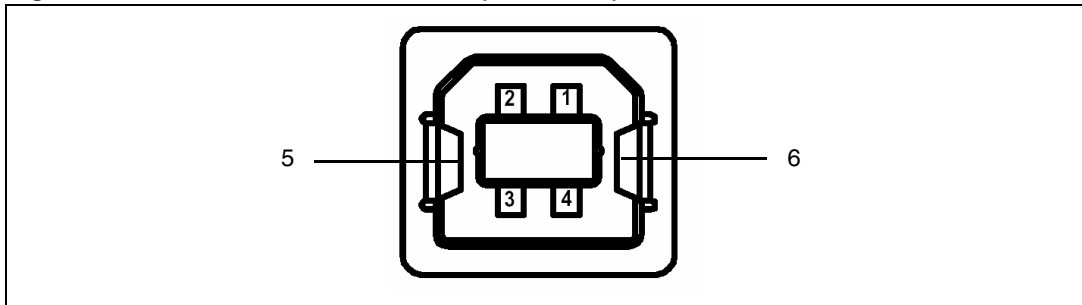

Table 19. ST-LINK USB connector (CN12)

Pin number	Description	Pin number	Description
1	VBUS (power)	4	GND
2	DM	5	Shield
3	DP	6	Shield

3.11 ST-LINK programming connector CN13

The connector CN13 is not mounted on the board and is reserved for manufacture only.

3.12 HDMI connectors CN15 and CN16

Figure 14. HDMI connectors CN15 and CN16

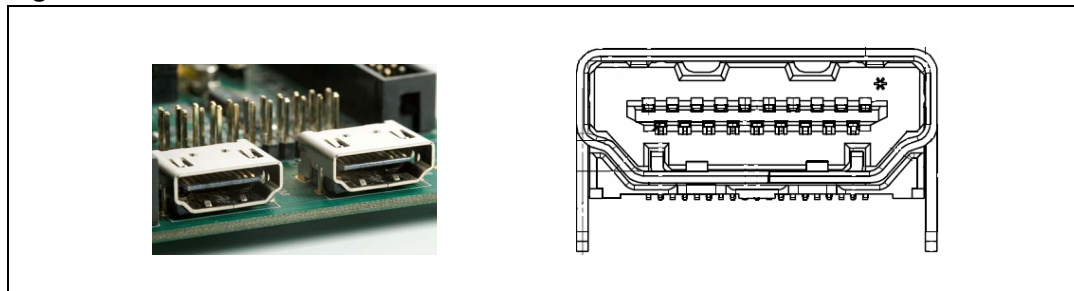

Table 20. HDMI connectors (CN15 and CN16)

Pin number	Description	Pin number	Description
1-12	NC	16	SDC (PB11)
13	CEC (PB8)	17	GND
14	NC	18	NC
15	SCL (PB10)	19	HPD (PB12)

4 Limitations

The MB871 board is delivered with PCB revision A or B. The PCB version is mentioned on the bottom right corner of the board. Both versions of PCB are fully compatible in configuration by default but several limitations on the PCB rev A are removed on PCB rev B. All PCB rev A limitations are explained in this chapter.

4.1 Boot switches

On PCB rev A, boot switches SW1 and SW2 are not referenced on the silkscreen. SW1 (Boot1) switch is located in the right position on the board and SW2 (Boot0) in left position.

4.2 PE14, PB14 and PA10 usage

When a daughterboard is connected to CN4, CN5 (extension connectors) if PE14, PB14 or PA10 are used on the daughterboard it is not possible to disconnect the signals assigned to these I/Os on the motherboard (MB871 rev A). On PCB rev B 0Ω resistors are placed on these signals allowing them to be disconnected when these I/O are used on the daughterboard.

Table 21. Missing resistors on PCB rev A

Resistor	Signal name
R115	PA10
R116	PB14
R117	PE14

4.3 Jumper JP3

On PCB rev A, JP3 can connect VBAT to PC1 with a jumper for battery voltage measurement using ADC_IN11. JP3 jumper must not be used to avoid unexpected current consumption on the battery when the board is not powered.

Note: The pin headers are removed to forbid jumper connection on JP3.

4.4 Audio amplifier volume

The volume of the sound is limited since the audio amplifier gain is lower than on rev B. On PCB rev A R1 (100 KΩ) is replaced by 22 KΩ and C1 (110 pF) is replaced by 330 pF.

4.5 IDD standby measurement

On PCB rev B it is possible to use jumper JP12 to connect IDD_CNT_EN (PE14) to Anti-tamper (PC13) to allow IDD measurement when the MCU is in standby (using the RTC alarm feature). This feature is not supported on PCB rev A as JP12 does not exist.

5 Schematics

This section provides design schematics for the STM32100B-EVAL key features to help you implement these features in your own application design.

This section includes:

- [Figure 15: Evaluation board schematics on page 29](#)
- [Figure 16: MCU on page 30](#)
- [Figure 17: Peripherals on page 31](#)
- [Figure 18: RS-232 on page 32](#)
- [Figure 19: Audio on page 33](#)
- [Figure 20: Joystick, LCD, tamper button, wakeup button, user button on page 34](#)
- [Figure 21: MicroSD Card and Flash on page 35](#)
- [Figure 22: Motor control on page 36](#)
- [Figure 23: JTAG and SWD debugger on page 37](#)
- [Figure 24: Power supply on page 38](#)
- [Figure 25: ST-LINK on page 39](#)
- [Figure 26: 2.4 inch color LCD board on page 40](#)

Figure 15. Evaluation board schematics

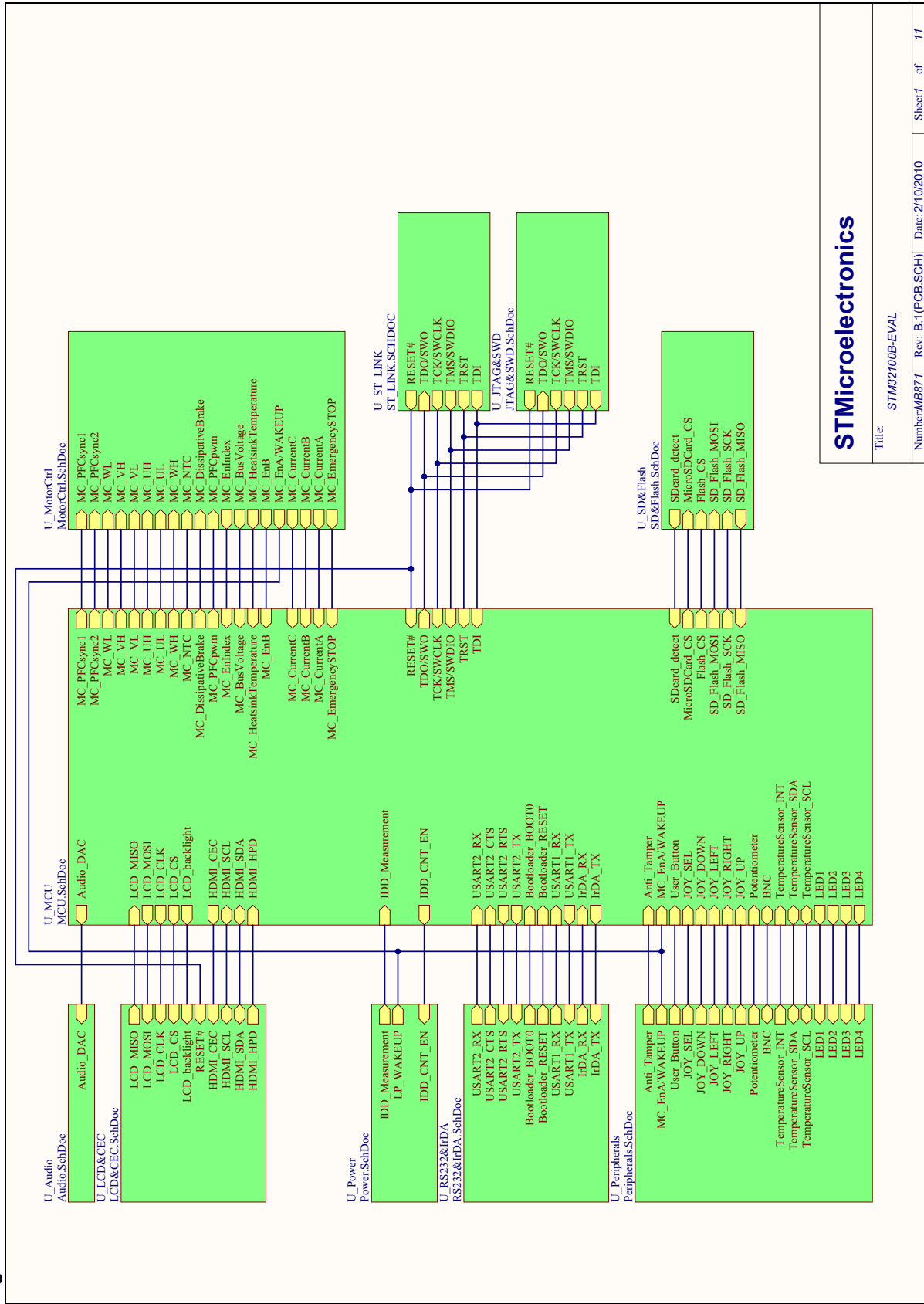

STMicroelectronics

Title: STM32100B-EVAL
 Number: MB871 | Rev: B.1(PCB_SCH) | Date: 2/10/2010 | Sheet 7 of 11



Figure 17. Peripherals

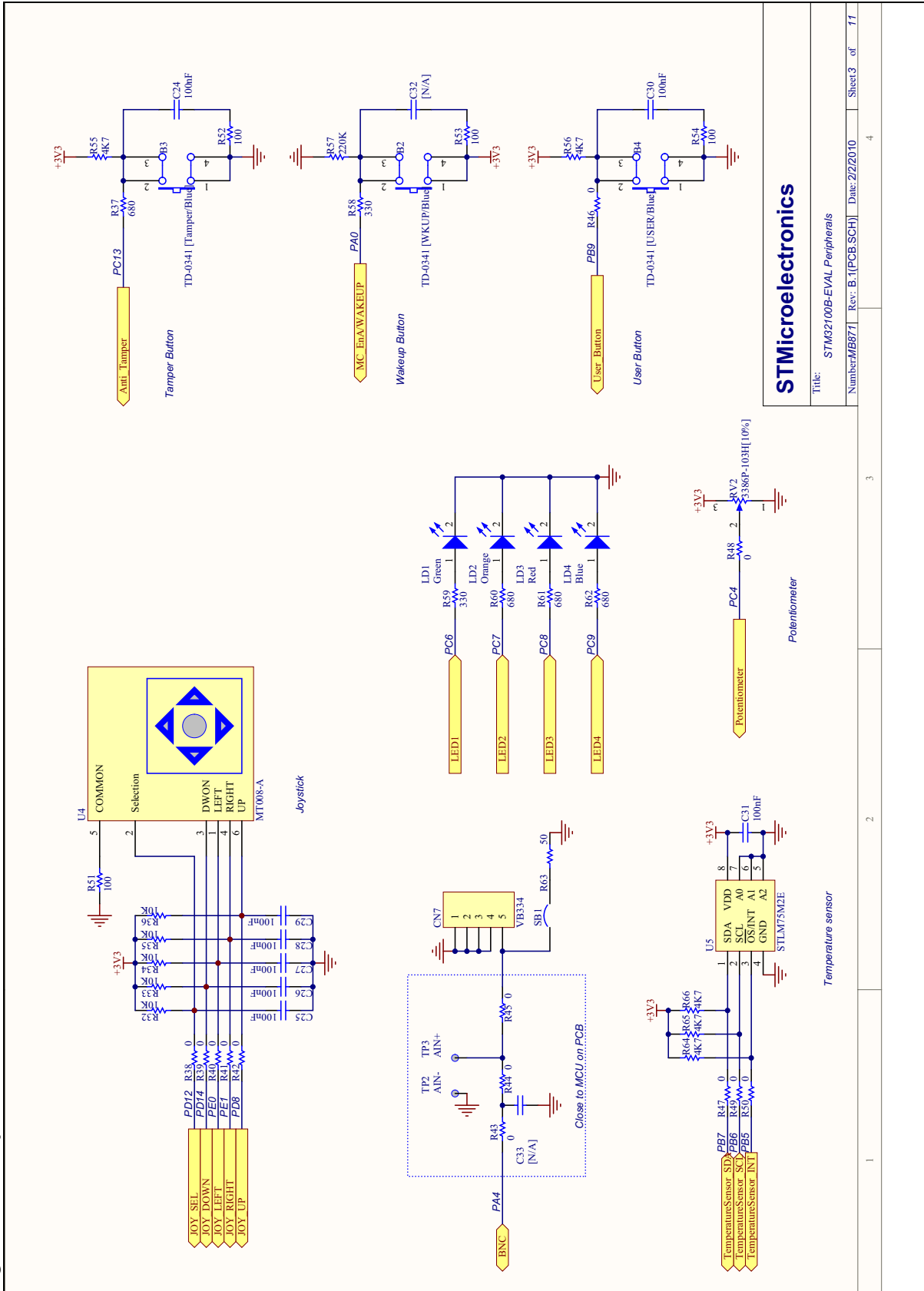

STMicroelectronics
 Title: STM32100B-EVAL_Peripherals
 Number/B871 Rev. B.1(PCB.SCH) Date: 2/2/2010 Sheet 3 of 11

1	2	3	4
---	---	---	---



Figure 18. RS-232

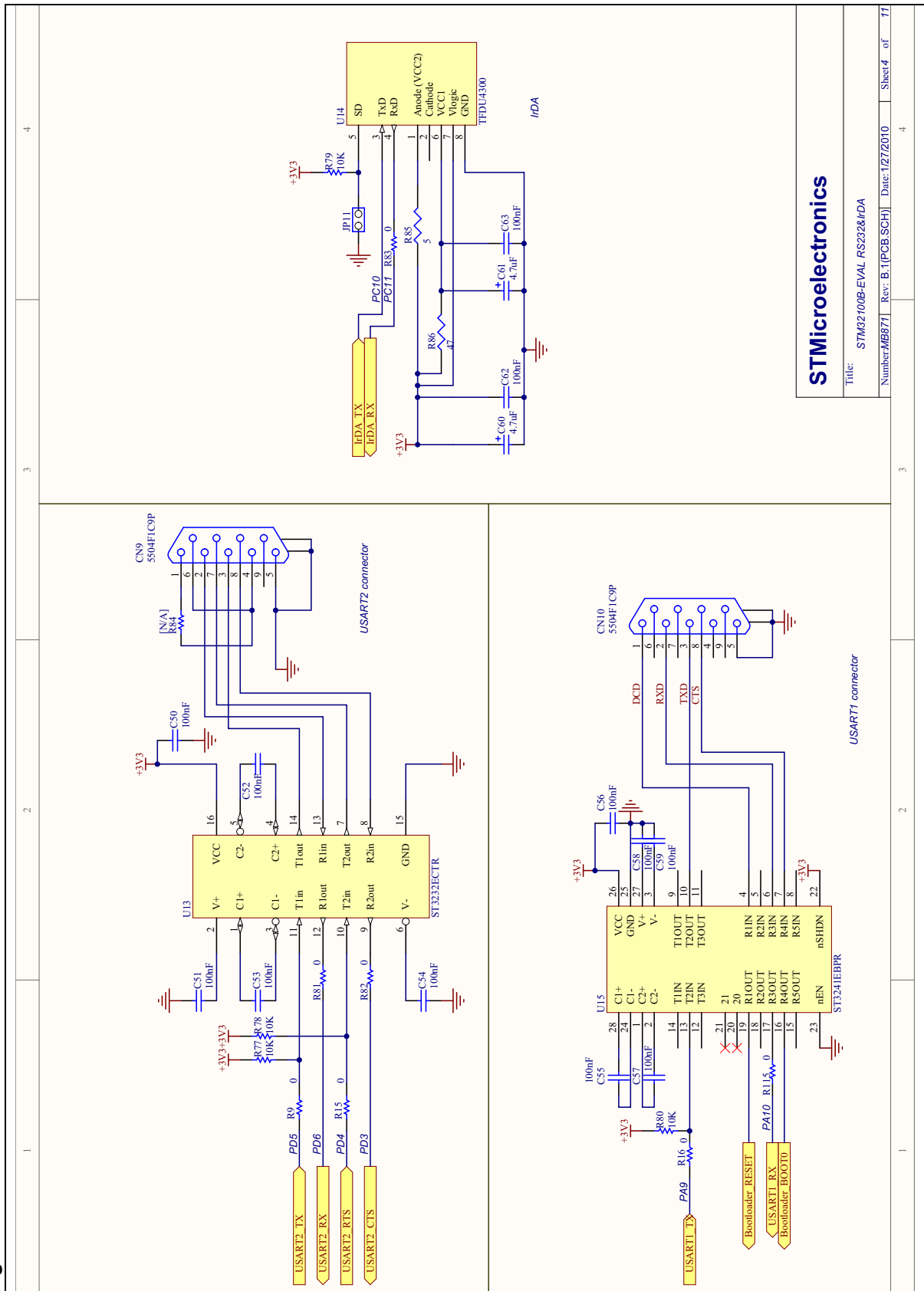

STMicroelectronics

Title: STM32100B-EVAL RS232&IrDA

Number/MB8771 Rev: B.1(PCB.SCH) Date:1/27/2010 Sheet 4 of 71

Figure 19. Audio

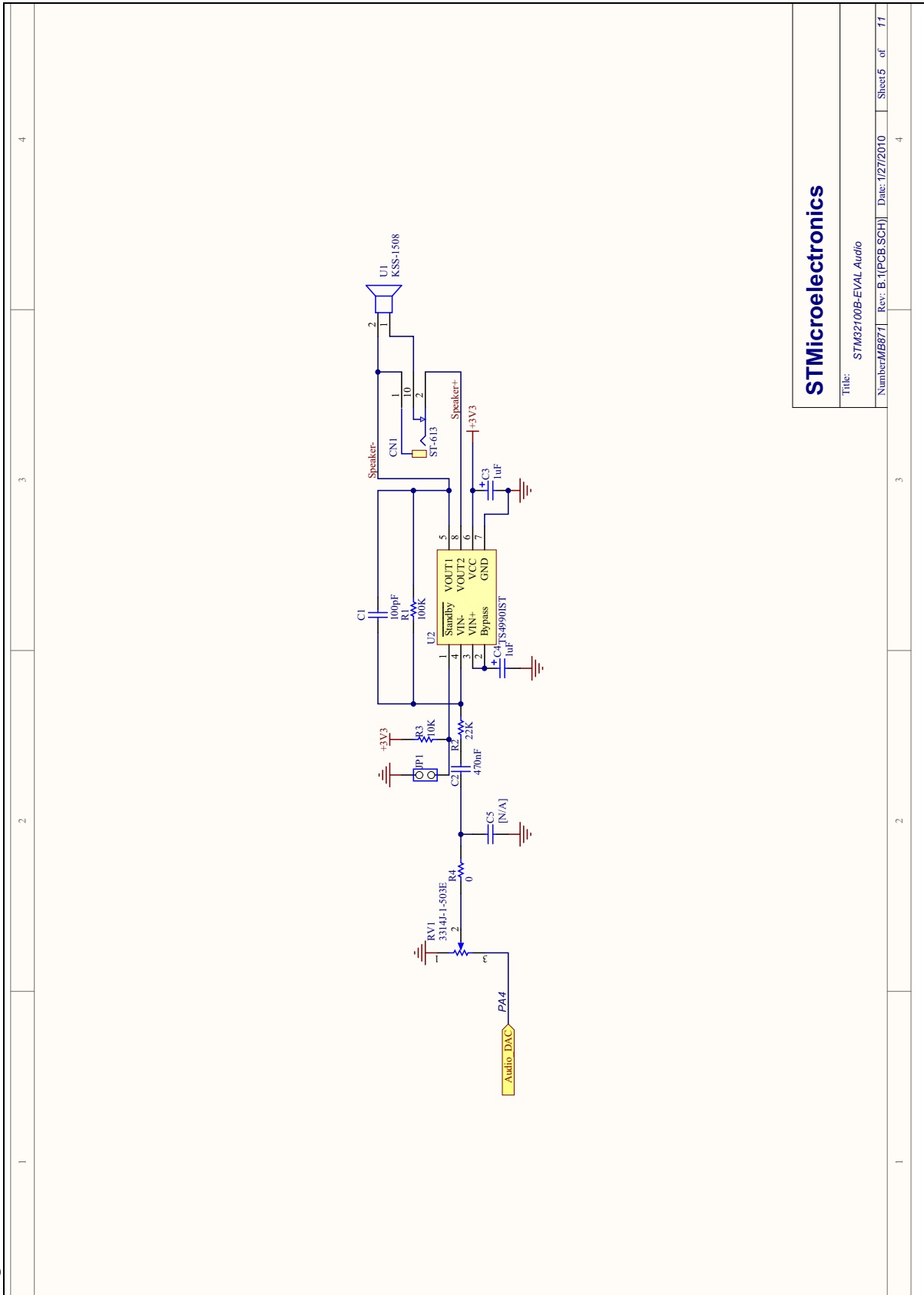

STMicroelectronics			
Title: STM32100B-EVAL Audio			
Number	MB871	Rev: B.1[PCB SCH]	Date: 1/27/2010
Sheet	5	of	11



Figure 20. Joystick, LCD, tamper button, wakeup button, user button

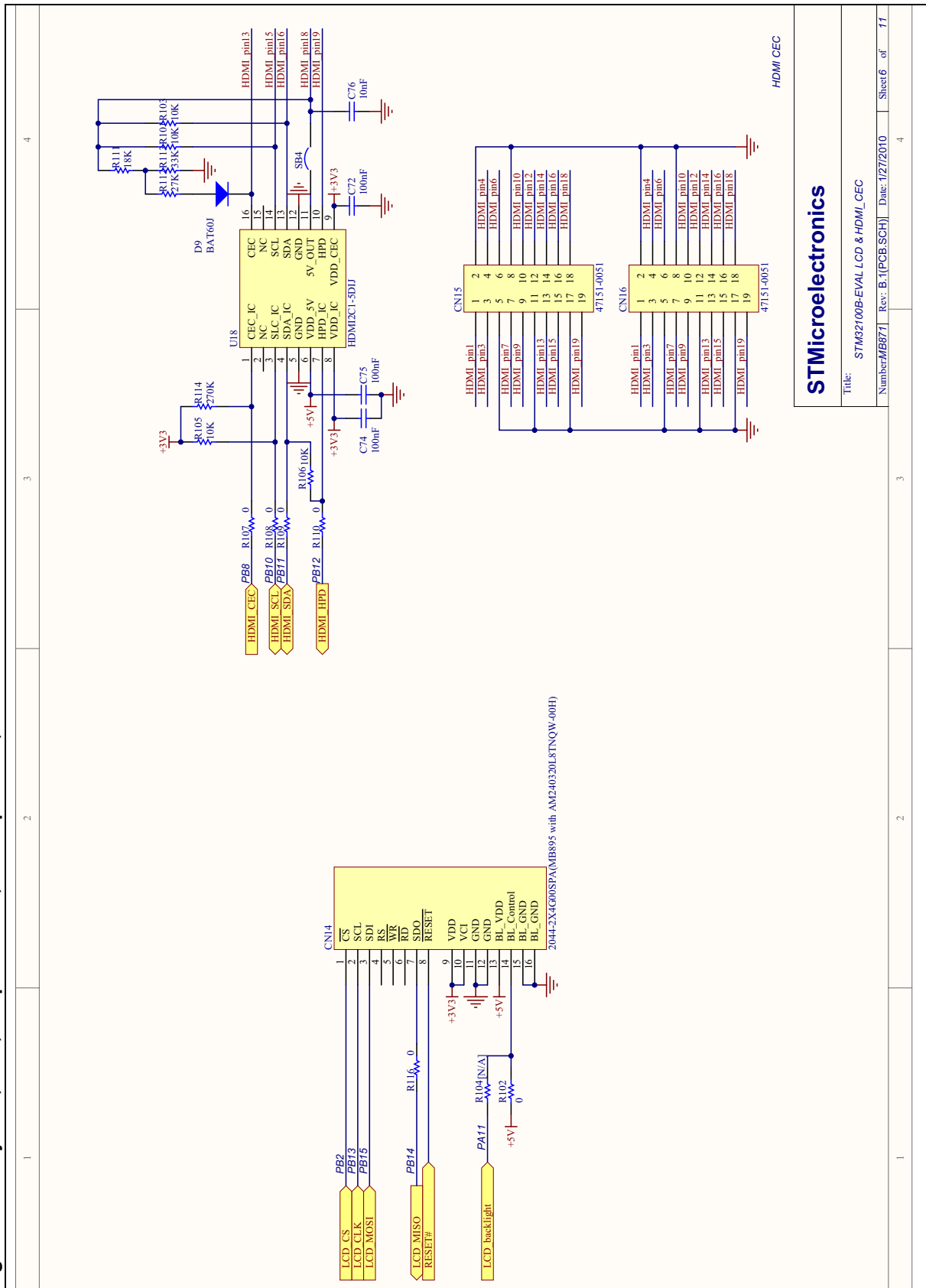

STMicroelectronics

Title: STM32100B-EVAL LCD & HDMI_CEC

Number: MB871 Rev. B: [PCB_SCH] Date: 1/27/2010 Sheet 6 of 71



Figure 21. MicroSD Card and Flash

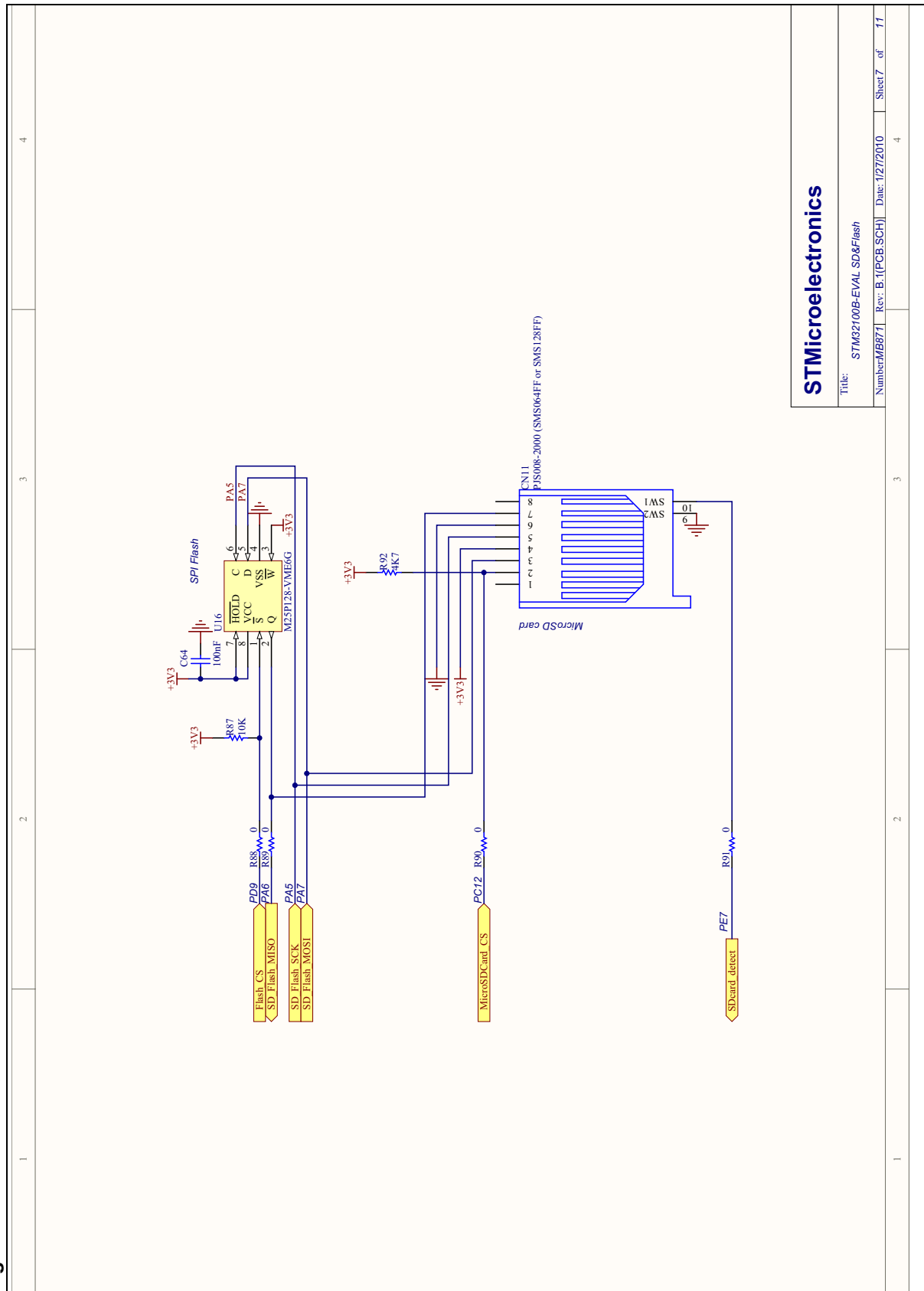

STMicroelectronics

Title: STM32100B-EVAL_SD&Flash
 Number/B871 Rev. B.1(PCB.SCH) Date: 1/27/2010 Sheet 7 of 11

Figure 22. Motor control

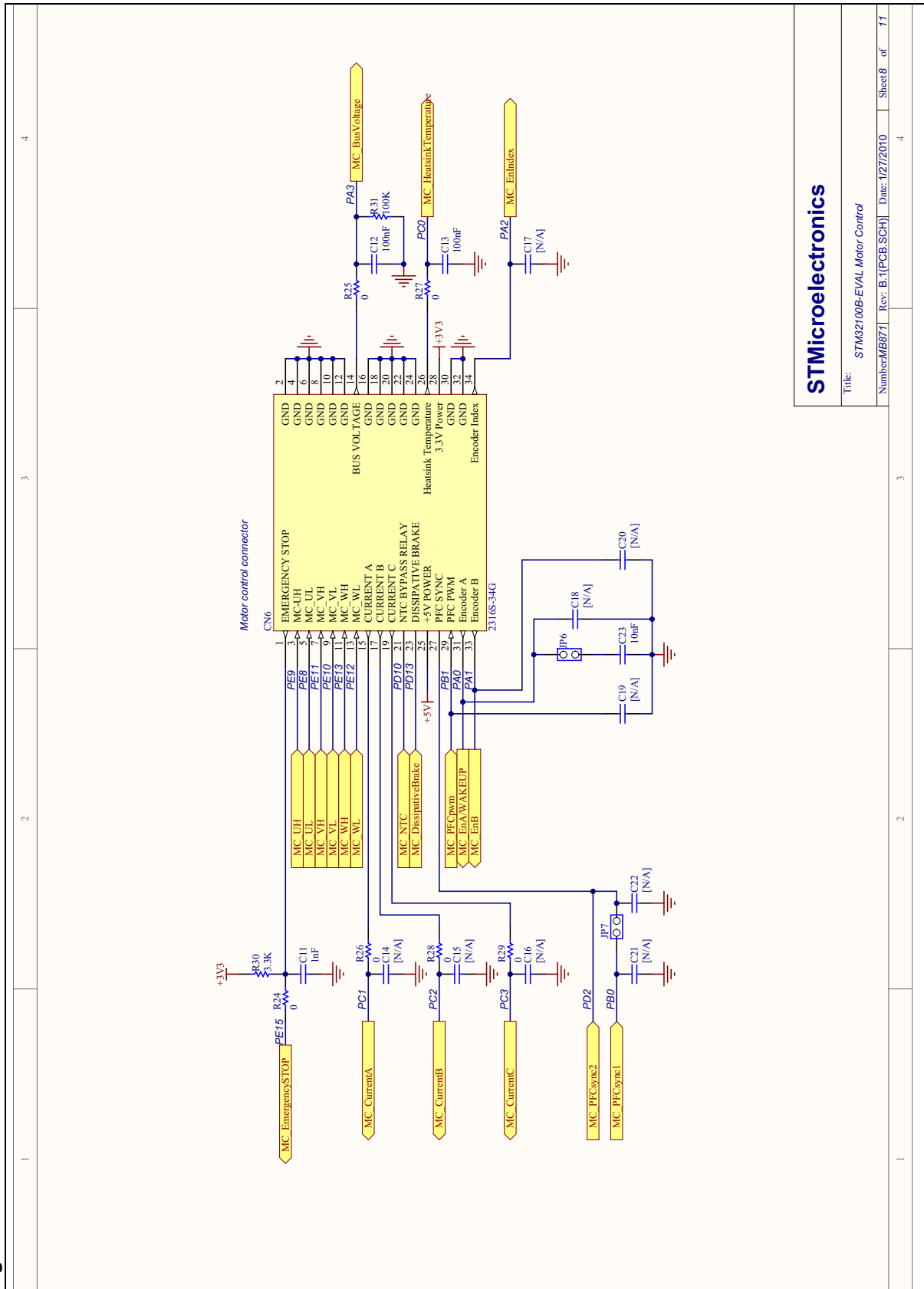

STMicroelectronics

Title: STM32100B-EVAL Motor Control

Number: MB871 Rev.: B.1 (PCB_SCH) Date: 1/27/2010 Sheet 8 of 11



Figure 23. JTAG and SWD debugger

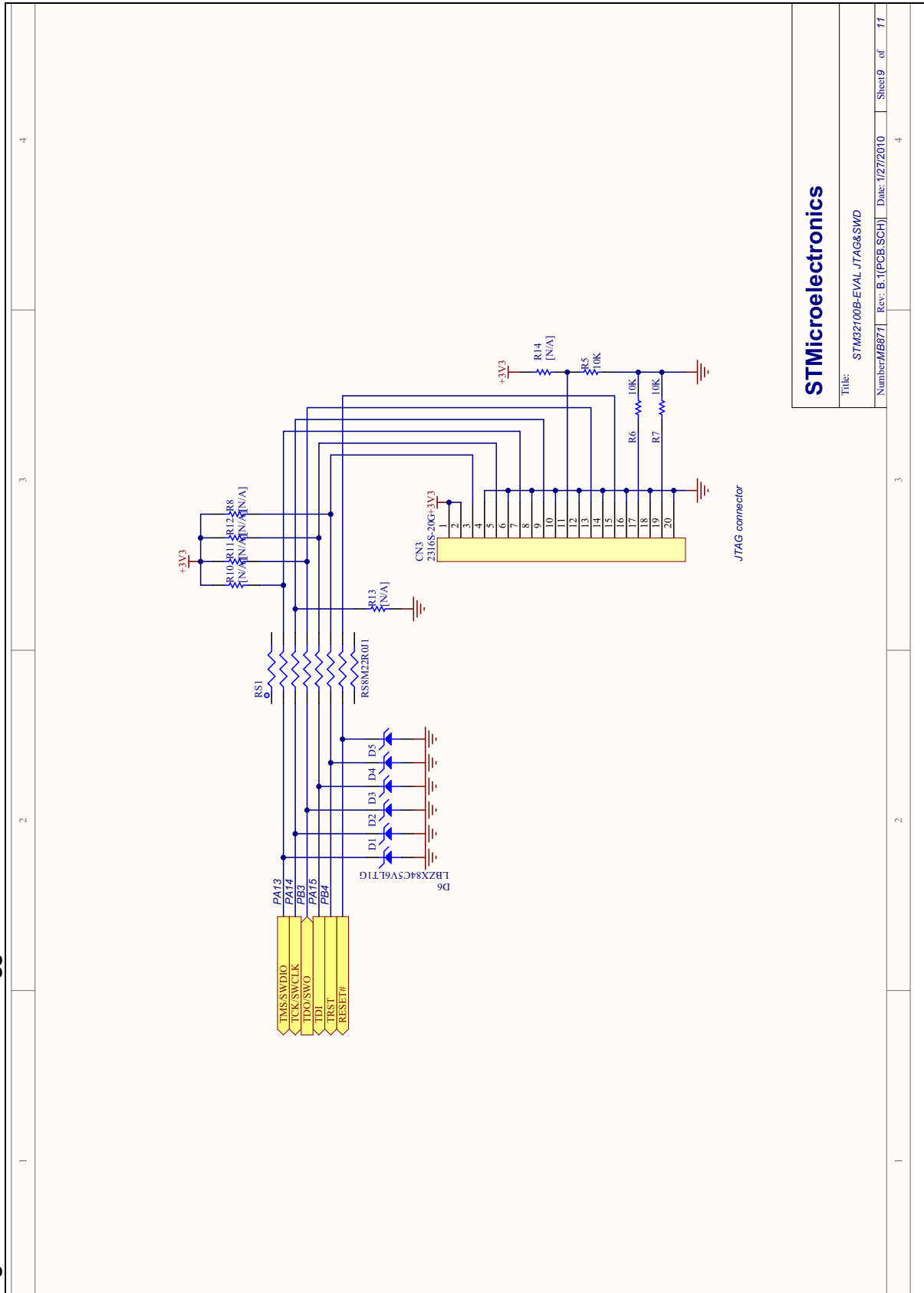

STMicroelectronics
 Title: STM32100B-EVAL JTAG&SWD
 Number/B871 Rev: B.1(PCB.SCH) Date: 1/27/2010 Sheet 9 of 11



Appendix A STM32100B-EVAL I/O assignments

Table 22. STM32100B-EVAL I/O assignments

LQFP100	Pin name	Type	EVAL board I/O assignment
1	PE2	I/O	
2	PE3	I/O	
3	PE4	I/O	
4	PE5	I/O	
5	PE6	I/O	
6	VBAT	S	
7	PC13-ANTL_TAMP	I/O	Anti-tamper button
8	PC14-OSC32_IN	I/O	32K OSC
9	PC15-OSC32_OUT	I/O	32K OSC
10	VSS_5	S	
11	VDD_5	S	
12	OSC_IN	I	
13	OSC_OUT	O	
14	NRST	I/O	
15	PC0	I/O	MC_ADC10 pin 26
16	PC1	I/O	MC_ADC11 pin 15 / VBAT ADCin
17	PC2	I/O	MC_ADC12 pin 17
18	PC3	I/O	MC_ADC13 pin 19
19	VSSA	S	
20	VREF-	S	
21	VREF+	S	
22	VDDA	S	
23	PA0-WKUP	I/O	MC_TIM2_CH1 pin 31 / WAKEUP Button
24	PA1	I/O	MC_TIM2_CH2 pin 33
25	PA2	I/O	MC_TIM2_CH3 pin 34
26	PA3	I/O	MC_ADC3 pin 14
27	VSS_4	S	
28	VDD_4	S	
29	PA4	I/O	DAC_OUT1_BNC / ADC_IN4_BNC
30	PA5	I/O	SD card/Flash CLK
31	PA6	I/O	SD card/Flash DO
32	PA7	I/O	SD card/Flash DI

Table 22. STM32100B-EVAL I/O assignments (continued)

LQFP100	Pin name	Type	EVAL board I/O assignment
33	PC4	I/O	Potentiometer
34	PC5	I/O	IDD_measure ADCin
35	PB0	I/O	MC_TIM3_CH3 pin 27
36	PB1	I/O	MC_TIM3_CH4 pin 29
37	PB2	I/O	Boot1/ CS LCD
38	PE7	I/O	SD card detect
39	PE8	I/O	MC_TIM1_CH1N pin 5
40	PE9	I/O	MC_TIM1_CH1 pin 3
41	PE10	I/O	MC_TIM1_CH2N pin 9
42	PE11	I/O	MC_TIM1_CH2 pin 7
43	PE12	I/O	MC_TIM1_CH3N pin 13
44	PE13	I/O	MC_TIM1_CH3 pin 11
45	PE14	I/O	IDD_CNT_EN
46	PE15	I/O	MC_STOP pin 1
47	PB10	I/O	HDMI_SCL
48	PB11	I/O	HDMI_SDA
49	VSS_1	S	
50	VDD_1	S	
51	PB12	I/O	HDMI_HPD
52	PB13	I/O	LCD_CLK
53	PB14	I/O	LCD_DO
54	PB15	I/O	LCD_DI
55	PD8	I/O	Joystick up
56	PD9	I/O	External Flash CS
57	PD10	I/O	MC_pin21
58	PD11	I/O	
59	PD12	I/O	Joystick select
60	PD13	I/O	MC_TIM4_CH2 pin 23
61	PD14	I/O	Joystick_Down
62	PD15	I/O	
63	PC6	I/O	LED1
64	PC7	I/O	LED2
65	PC8	I/O	LED3
66	PC9	I/O	LED4
67	PA8	I/O	MCO

Table 22. STM32100B-EVAL I/O assignments (continued)

LQFP100	Pin name	Type	EVAL board I/O assignment
68	PA9	I/O	UASRT1_TX
69	PA10	I/O	UART1_RX
70	PA11	I/O	LCD backlight
71	PA12	I/O	
72	PA13	I/O	Debug TMS
73	NC	?	
74	VSS_2	S	
75	VDD_2	S	
76	PA14	I/O	Debug TCK
77	PA15	I/O	Debug TDI
78	PC10	I/O	IRDA TX
79	PC11	I/O	IRDA RX
80	PC12	I/O	SD card CS
81	PD0	I/O	
82	PD1	I/O	
83	PD2	I/O	MC_TIM3_ETR pin 27
84	PD3	I/O	UART2 CTS
85	PD4	I/O	UART2 RTS
86	PD5	I/O	UART2 TX
87	PD6	I/O	UART2 RX
88	PD7	I/O	
89	PB3	I/O	Debug TDO
90	PB4	I/O	Debug TRST
91	PB5	I/O	Temperature SMBIA
92	PB6	I/O	Temperature SCL
93	PB7	I/O	Temperature SDA
94	BOOT0	I	
95	PB8	I/O	HDMI_CEC
96	PB9	I/O	User button
97	PE0	I/O	Joystick right
98	PE1	I/O	Joystick left
99	VSS_3	S	
100	VDD_3	S	

Revision history

Date	Revision	Changes
25-Feb-2010	1	Initial release.
25-Feb-2010	2	Modified Section 2.15.3 .
24-Sep-2012	3	Added "Caution" to Section 2.1 . Replaced Figure 25: ST-LINK . Added Figure 26: 2.4 inch color LCD board .

Please Read Carefully:

Information in this document is provided solely in connection with ST products. STMicroelectronics NV and its subsidiaries ("ST") reserve the right to make changes, corrections, modifications or improvements, to this document, and the products and services described herein at any time, without notice.

All ST products are sold pursuant to ST's terms and conditions of sale.

Purchasers are solely responsible for the choice, selection and use of the ST products and services described herein, and ST assumes no liability whatsoever relating to the choice, selection or use of the ST products and services described herein.

No license, express or implied, by estoppel or otherwise, to any intellectual property rights is granted under this document. If any part of this document refers to any third party products or services it shall not be deemed a license grant by ST for the use of such third party products or services, or any intellectual property contained therein or considered as a warranty covering the use in any manner whatsoever of such third party products or services or any intellectual property contained therein.

UNLESS OTHERWISE SET FORTH IN ST'S TERMS AND CONDITIONS OF SALE ST DISCLAIMS ANY EXPRESS OR IMPLIED WARRANTY WITH RESPECT TO THE USE AND/OR SALE OF ST PRODUCTS INCLUDING WITHOUT LIMITATION IMPLIED WARRANTIES OF MERCHANTABILITY, FITNESS FOR A PARTICULAR PURPOSE (AND THEIR EQUIVALENTS UNDER THE LAWS OF ANY JURISDICTION), OR INFRINGEMENT OF ANY PATENT, COPYRIGHT OR OTHER INTELLECTUAL PROPERTY RIGHT.

UNLESS EXPRESSLY APPROVED IN WRITING BY TWO AUTHORIZED ST REPRESENTATIVES, ST PRODUCTS ARE NOT RECOMMENDED, AUTHORIZED OR WARRANTED FOR USE IN MILITARY, AIR CRAFT, SPACE, LIFE SAVING, OR LIFE SUSTAINING APPLICATIONS, NOR IN PRODUCTS OR SYSTEMS WHERE FAILURE OR MALFUNCTION MAY RESULT IN PERSONAL INJURY, DEATH, OR SEVERE PROPERTY OR ENVIRONMENTAL DAMAGE. ST PRODUCTS WHICH ARE NOT SPECIFIED AS "AUTOMOTIVE GRADE" MAY ONLY BE USED IN AUTOMOTIVE APPLICATIONS AT USER'S OWN RISK.

Resale of ST products with provisions different from the statements and/or technical features set forth in this document shall immediately void any warranty granted by ST for the ST product or service described herein and shall not create or extend in any manner whatsoever, any liability of ST.

ST and the ST logo are trademarks or registered trademarks of ST in various countries.

Information in this document supersedes and replaces all information previously supplied.

The ST logo is a registered trademark of STMicroelectronics. All other names are the property of their respective owners.

© 2012 STMicroelectronics - All rights reserved

STMicroelectronics group of companies

Australia - Belgium - Brazil - Canada - China - Czech Republic - Finland - France - Germany - Hong Kong - India - Israel - Italy - Japan - Malaysia - Malta - Morocco - Philippines - Singapore - Spain - Sweden - Switzerland - United Kingdom - United States of America

www.st.com

