

NCS210, NCS211, NCS212, NCS213, NCS214, NCS215

Current-Shunt Monitor, Voltage Output, Bi-Directional Zero-Drift

The NCS210, NCS211, NCS212, NCS213, NCS214, and NCS215 are voltage output current shunt monitors that can measure voltage across shunts at common-mode voltages from -0.3 V to 26 V , independent of supply voltage. Six fixed gains are available: 50 V/V , 75 V/V , 100 V/V , 200 V/V , 500 V/V , or 1000 V/V . The low offset of the zero-drift architecture enables current sensing with maximum drops across the shunt as low as 10 mV full-scale.

The devices can operate from a single $+2.7\text{ V}$ to $+26\text{ V}$ power supply, drawing a maximum of $100\text{ }\mu\text{A}$ of supply current. All versions are specified over the extended operating temperature range (-40°C to $+125^{\circ}\text{C}$). Available in SC-70 and thin UQFN space-saving packages.

Features

- Wide Common-Mode Input Range -0.3 V to 26 V
- Supply Voltage Range from 2.7 V to 26 V
- Low Offset Voltage $\pm 60\text{ }\mu\text{V}$ Max
- Low Offset Drift ($0.1\text{ }\mu\text{V}/^{\circ}\text{C}$)
- Low Gain Error (max 1%)
- Rail-to-rail Input and Output Capability
- Low Current Consumption (typ $65\text{ }\mu\text{A}$, $100\text{ }\mu\text{A}$ max)
- NCV Prefix for Automotive and Other Applications Requiring Unique Site Qualified and PPAP Capable
- These Devices are Pb-Free, Halogen Free/BFR Free and are RoHS Compliant

Typical Applications

- Current Sensing (High-Side/Low-Side)
- Automotive
- Telecom
- Sensors

This document contains information on some products that are still under development. ON Semiconductor reserves the right to change or discontinue these products without notice.



ON Semiconductor®

www.onsemi.com



SC70-6
SQ SUFFIX
CASE 419B



1 UQFN10
MU SUFFIX
CASE 488AT

PIN CONNECTIONS

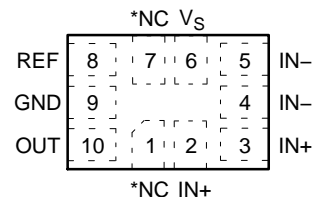
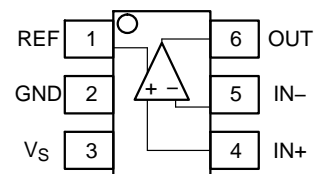

*NC denotes no internal connection. These pins can be left floating or connected to any voltage between V_s and GND.

MARKING DIAGRAMS

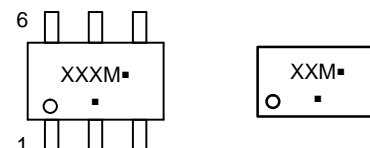

XXX = Specific Device Code (See page 4)

M = Date Code

▪ = Pb-Free Package

(Note: Microdot may be in either location)

| Product | Gain | R3-R4 | R1-R2 |
|---------|------|-----------------|--------------|
| NCS213 | 50 | 20 k Ω | 1 M Ω |
| NCS215 | 75 | 13.3 k Ω | 1 M Ω |
| NCS214 | 100 | 10 k Ω | 1 M Ω |
| NCS210 | 200 | 5 k Ω | 1 M Ω |
| NCS211 | 500 | 2 k Ω | 1 M Ω |
| NCS212 | 1000 | 1 k Ω | 1 M Ω |

$$V_{\text{OUT}} = (I_{\text{LOAD}} \times R_{\text{SHUNT}}) \text{GAIN} + V_{\text{REF}}$$

ORDERING INFORMATION

See detailed ordering, marking and shipping information on page 4 of this data sheet.

NCS210, NCS211, NCS212, NCS213, NCS214, NCS215

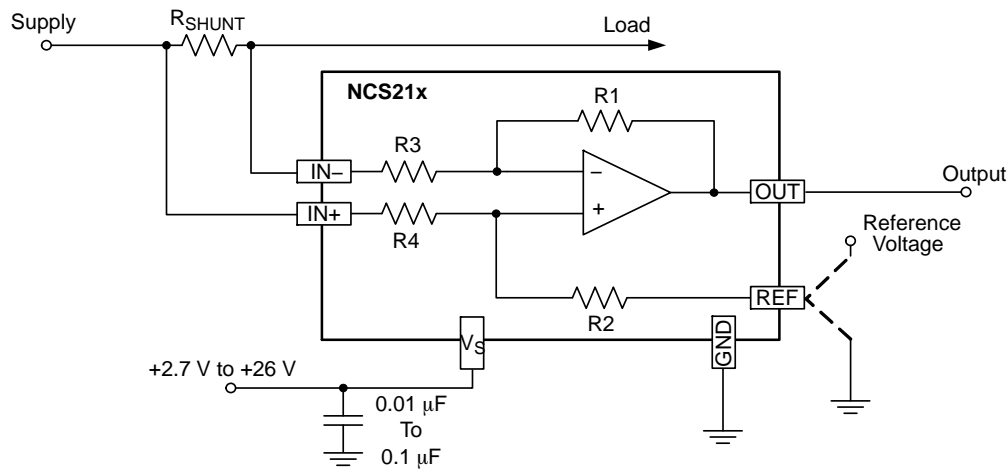

Figure 1. Application Schematic

Table 1. MAXIMUM RATINGS

| Rating | | Symbol | Value | Unit |
|---|--|--------------------|---------------------------|------|
| Supply Voltage (Note 1) | NCS21x NCV21x | V_S | +26 +28 | V |
| Analog Inputs | Differential (V_{IN+} – V_{IN-}) | V_{IN+}, V_{IN-} | –26 to +26 | V |
| | Common-Mode (Note 2) | | NCS21x NCV21x | |
| REF Input | | V_{REF} | GND–0.3 to (V_S) +0.3 | V |
| Output (Note 2) | | V_{OUT} | GND–0.3 to (V_S) +0.3 | V |
| Input Current into Any Pin (Note 2) | | | 5 | mA |
| Maximum Junction Temperature | | $T_{J(max)}$ | +150 | °C |
| Storage Temperature Range | | TSTG | –65 to +150 | °C |
| ESD Capability, Human Body Model (Note 3) | | HBM | ±3000 | V |
| ESD Capability, Machine Model (Note 3) | | MM | ±100 | V |
| Charged Device Model (Note 3) | | CDM | ±1000 | V |

Stresses exceeding those listed in the Maximum Ratings table may damage the device. If any of these limits are exceeded, device functionality should not be assumed, damage may occur and reliability may be affected.

1. Refer to ELECTRICAL CHARACTERISTICS, RECOMMENDED OPERATING RANGES and/or APPLICATION INFORMATION for safe operating parameters.
2. Input voltage at any pin may exceed the voltage shown if current at that pin is limited to 5 mA.
3. This device series incorporates ESD protection and is tested by the following methods
 ESD Human Body Model tested per AEC–Q100–002 (EIA/JESD22–A114)
 ESD Machine Model tested per AEC–Q100–003 (EIA/JESD22–A115)
 ESD Charged Device Model tested per AEC–Q100–011.
 Latchup Current Maximum Rating: 50 mA per JEDEC standard: JESD78

Table 2. THERMAL CHARACTERISTICS

| Rating | Symbol | Value | Unit |
|--|-----------------|-------|------|
| Thermal Characteristics, SC70 (Note 4) Thermal Resistance, Junction–to–Air (Note 5) | $R_{\theta JA}$ | 250 | °C/W |

4. Refer to ELECTRICAL CHARACTERISTICS, RECOMMENDED OPERATING RANGES and/or APPLICATION INFORMATION for safe operating parameters.
5. Values based on copper area of 645 mm² (or 1 in²) of 1 oz copper thickness and FR4 PCB substrate.

Table 3. RECOMMENDED OPERATING RANGES

| Rating | Symbol | Min | Max | Unit |
|---------------------|--------|-----|-----|------|
| Supply Voltage | V_S | 2.7 | 26 | V |
| Ambient Temperature | T_A | –40 | 125 | °C |

Functional operation above the stresses listed in the Recommended Operating Ranges is not implied. Extended exposure to stresses beyond the Recommended Operating Ranges limits may affect device reliability.

NCS210, NCS211, NCS212, NCS213, NCS214, NCS215

Table 4. ELECTRICAL CHARACTERISTICS

Boldface limits apply over the specified temperature range, $T_A = -40^\circ\text{C}$ to 125°C , guaranteed by characterization and/or design.

At $T_A = +25^\circ\text{C}$, $V_{\text{SENSE}} = V_{\text{IN}+} - V_{\text{IN}-}$.

NCS210, NCS213, NCS214 and NCS215: $V_S = +5\text{ V}$, $V_{\text{IN}+} = 12\text{ V}$, and $V_{\text{REF}} = V_S/2$, unless otherwise noted.

NCS211 and NCS212: $V_S = +12\text{ V}$, $V_{\text{IN}+} = 12\text{ V}$, and $V_{\text{REF}} = V_S/2$, unless otherwise noted.

| Parameter | Test Conditions | Symbol | Min | Typ | Max | Unit |
|--|--|--------|-----|---------------------------------------|-----------------------------|-----------------------|
| GAIN | | | | | | |
| NCS210 NCS211 NCS212 NCS213 NCS214 NCS215 | | G | | 200 500 1000 50 100 75 | | V/V |
| Gain Error | $V_{\text{SENSE}} = -5\text{ mV to }5\text{ mV}$ | G_e | | ± 0.2 | ± 1 | % |
| | NCV210 | G_e | | ± 0.2 | ± 1.5 | % |
| Gain Error vs. Temperature | $T_A = -10^\circ\text{C to }125^\circ\text{C}$ | | | 7 | 14 | ppm/ $^\circ\text{C}$ |
| | NCV210 | | | 7 | 70 | ppm/ $^\circ\text{C}$ |
| Nonlinearity Error | $V_{\text{SENSE}} = -5\text{ mV to }5\text{ mV}$ | | | ± 0.01 | | % |
| Maximum Capacitive Load | No sustained oscillation | | | 1 | | nF |

VOLTAGE OFFSET

| | | | | | | | |
|-----------------------------|--|----------------------------------|---------------------|--|------------|------------|------------------------------|
| Offset Voltage (RTI Note 6) | NCS210, NCS211, NCS212, NCS214, NCS215 | $V_{\text{SENSE}} = 0\text{ mV}$ | V_{OS} | | ± 0.55 | ± 60 | μV |
| | NCS213 | | | | ± 5 | ± 100 | μV |
| | NCV210 | | | | ± 0.55 | ± 90 | μV |
| Offset Drift | | | $\delta V/\delta T$ | | 0.1 | 0.6 | $\mu\text{V}/^\circ\text{C}$ |
| | NCS213 | | $\delta V/\delta T$ | | 0.5 | 1.5 | $\mu\text{V}/^\circ\text{C}$ |
| | NCV210 | | $\delta V/\delta T$ | | 0.1 | 1.0 | $\mu\text{V}/^\circ\text{C}$ |

INPUT

| | | | | | | | |
|---------------------------------|--|---|-----------------|-------------|------------|-----------|---------------|
| Input Bias Current | | $V_{\text{SENSE}} = 0\text{ mV}$ | I_{IB} | | | 60 | μA |
| Common-Mode Input Voltage Range | | | V_{CM} | -0.3 | | 26 | V |
| Common-Mode Rejection Ratio | NCS210, NCS211, NCS212, NCS214, NCS215 | $V_S = 5\text{ V}$, $V_{\text{IN}+} = 2\text{ V to }+26\text{ V}$, $V_{\text{SENSE}} = 0\text{ mV}$ | CMRR | 103 | 115 | | dB |
| | | $V_S = 3.3\text{ V}$, $V_{\text{IN}+} = 3\text{ V to }+26\text{ V}$, $V_{\text{SENSE}} = 0\text{ mV}$ | | 103 | 115 | | dB |
| | | $V_S = 3.3\text{ V}$, $V_{\text{IN}+} = 0\text{ V to }+26\text{ V}$, $V_{\text{SENSE}} = 0\text{ mV}$ ($T_A = -10^\circ\text{C to }85^\circ\text{C}$) | | 103 | 120 | | dB |
| Common-Mode Rejection Ratio | NCS213 | $V_S = 5\text{ V}$, $V_{\text{IN}+} = 2\text{ V to }+26\text{ V}$, $V_{\text{SENSE}} = 0\text{ mV}$ | CMRR | 97 | 110 | | dB |
| | | $V_S = 3.3\text{ V}$, $V_{\text{IN}+} = 3\text{ V to }+26\text{ V}$, $V_{\text{SENSE}} = 0\text{ mV}$ | | 97 | 110 | | dB |
| | | $V_S = 3.3\text{ V}$, $V_{\text{IN}+} = 0\text{ V to }+26\text{ V}$, $V_{\text{SENSE}} = 0\text{ mV}$ ($T_A = -10^\circ\text{C to }85^\circ\text{C}$) | | 97 | 115 | | dB |
| Common-Mode Rejection Ratio | NCV210 | $V_S = 5\text{ V}$, $V_{\text{IN}+} = 2\text{ V to }+26\text{ V}$, $V_{\text{SENSE}} = 0\text{ mV}$ | CMRR | 100 | 115 | | dB |
| | | $V_S = 3.3\text{ V}$, $V_{\text{IN}+} = 3\text{ V to }+26\text{ V}$, $V_{\text{SENSE}} = 0\text{ mV}$ | | 100 | 115 | | dB |

OUTPUT

| | | | | | | |
|---------------------|--|-----------------|--|-------------|------------|----|
| Output Voltage Low | Referenced from GND $R_L = 10\text{ k}\Omega$ to Ground | V_{OL} | | 5 | 50 | mV |
| Output Voltage High | Referenced from V_S $R_L = 10\text{ k}\Omega$ to Ground | V_{OH} | | 0.05 | 0.2 | V |

NCS210, NCS211, NCS212, NCS213, NCS214, NCS215

Table 4. ELECTRICAL CHARACTERISTICS

Boldface limits apply over the specified temperature range, $T_A = -40^\circ\text{C}$ to 125°C , guaranteed by characterization and/or design.

At $T_A = +25^\circ\text{C}$, $V_{\text{SENSE}} = V_{\text{IN}+} - V_{\text{IN}-}$.

NCS210, NCS213, NCS214 and NCS215: $V_S = +5\text{ V}$, $V_{\text{IN}+} = 12\text{ V}$, and $V_{\text{REF}} = V_S/2$, unless otherwise noted.

NCS211 and NCS212: $V_S = +12\text{ V}$, $V_{\text{IN}+} = 12\text{ V}$, and $V_{\text{REF}} = V_S/2$, unless otherwise noted.

| Parameter | Test Conditions | Symbol | Min | Typ | Max | Unit |
|---------------------------------|--|--------|-----|-----------------------------------|-----|------------------|
| DYNAMIC PERFORMANCE | | | | | | |
| Bandwidth ($f_{-3\text{dB}}$) | $C_{\text{LOAD}} = 10\text{ pF}$, NCS210 $C_{\text{LOAD}} = 10\text{ pF}$, NCS211 $C_{\text{LOAD}} = 10\text{ pF}$, NCS212 $C_{\text{LOAD}} = 10\text{ pF}$, NCS213 $C_{\text{LOAD}} = 10\text{ pF}$, NCS214 $C_{\text{LOAD}} = 10\text{ pF}$, NCS215 | BW | | 40 25 10 100 60 50 | | kHz |
| Slew Rate | | SR | | 0.4 | | V/ μs |

NOISE

| | | | | | | |
|--------------------------------------|--|-------|--|----|--|------------------------|
| Spectral Density, 1 kHz (RTI Note 6) | | e_n | | 35 | | nV/ $\sqrt{\text{Hz}}$ |
|--------------------------------------|--|-------|--|----|--|------------------------|

POWER SUPPLY

| | | | | | | |
|------------------------------------|--|-----------------|------------|-----------|------------|-----------------|
| Operating Voltage Range | $V_{\text{SENSE}} = 0\text{ mV}$ | V_S | 2.7 | | 26 | V |
| Quiescent Current | $V_{\text{SENSE}} = 0\text{ mV}$ | I_{DD} | | 65 | 100 | μA |
| Quiescent Current over Temperature | $V_{\text{SENSE}} = 0\text{ mV}$ | | | | 115 | μA |
| Power Supply Rejection Ratio | $V_S = +2.7\text{ V}$ to $+26\text{ V}$, $V_{\text{IN}+} = 18\text{ V}$, $V_{\text{SENSE}} = 0\text{ mV}$ | PSRR | | ± 0.1 | ± 10 | $\mu\text{V/V}$ |

6. RTI = referenced-to-input.

ORDERING INFORMATION

| Device | Gain | Marking | Package | Shipping [†] |
|----------------------------------|------|---------|---------------------|-----------------------|
| NCS210SQT2G | 200 | AAP | SC70-6 (Pb-Free) | 3000 / Tape and Reel |
| NCS211SQT2G | 500 | AAM | | |
| NCS212SQT2G (In Development)** | 1000 | AAN | | |
| NCS213SQT2G (In Development)** | 50 | AAQ | | |
| NCS214SQT2G (In Development)** | 100 | AAR | | |
| NCS215SQT2G (In Development)** | 75 | AAT | | |
| NCV210SQT2G * | 200 | VAP | | |
| NCV211SQT2G * (In Development)** | 500 | VAM | | |
| NCV212SQT2G * (In Development)** | 1000 | VAN | | |
| NCV213SQT2G * (In Development)** | 50 | VAQ | | |
| NCV214SQT2G * (In Development)** | 100 | VAR | | |
| NCV215SQT2G * (In Development)** | 75 | VAT | | |
| NCS210MUTAG (In Development)** | 200 | TBD | UQFN10 (Pb-Free) | 3000 / Tape and Reel |
| NCS211MUTAG (In Development)** | 500 | TBD | | |
| NCS212MUTAG (In Development)** | 1000 | TBD | | |
| NCS213MUTAG (In Development)** | 50 | TBD | | |
| NCS214MUTAG (In Development)** | 100 | TBD | | |
| NCS215MUTAG (In Development)** | 75 | TBD | | |

[†]For information on tape and reel specifications, including part orientation and tape sizes, please refer to our Tape and Reel Packaging Specifications Brochure, BRD8011/D

*NCV Prefix for Automotive and Other Applications Requiring Unique Site and Control Change Requirements; AEC-Q100 Qualified and PPAP Capable.

** Contact local sales office for availability.

NCS210, NCS211, NCS212, NCS213, NCS214, NCS215

PACKAGE DIMENSIONS

SC-88/SC70-6/SOT-363
CASE 419B-02
ISSUE Y

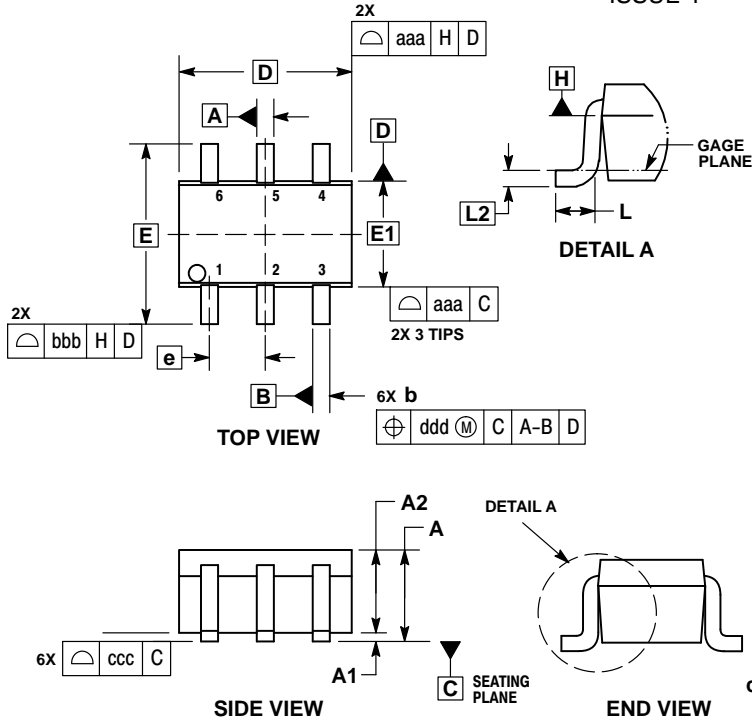

NOTES:

1. DIMENSIONING AND TOLERANCING PER ASME Y14.5M, 1994.
2. CONTROLLING DIMENSION: MILLIMETERS.
3. DIMENSIONS D AND E1 DO NOT INCLUDE MOLD FLASH, PROTRUSIONS, OR GATE BURRS. MOLD FLASH, PROTRUSIONS, OR GATE BURRS SHALL NOT EXCEED 0.20 PER END.
4. DIMENSIONS D AND E1 AT THE OUTERMOST EXTREMES OF THE PLASTIC BODY AND DATUM H.
5. DATUMS A AND B ARE DETERMINED AT DATUM H.
6. DIMENSIONS b AND c APPLY TO THE FLAT SECTION OF THE LEAD BETWEEN 0.08 AND 0.15 FROM THE TIP.
7. DIMENSION b DOES NOT INCLUDE DAMBAR PROTRUSION. ALLOWABLE DAMBAR PROTRUSION SHALL BE 0.08 TOTAL IN EXCESS OF DIMENSION b AT MAXIMUM MATERIAL CONDITION. THE DAMBAR CANNOT BE LOCATED ON THE LOWER RADIUS OF THE FOOT.

| DIM | MILLIMETERS | | | INCHES | | |
|-----|-------------|------|------|-----------|-------|-------|
| | MIN | NOM | MAX | MIN | NOM | MAX |
| A | --- | --- | 1.10 | --- | --- | 0.043 |
| A1 | 0.00 | --- | 0.10 | 0.000 | --- | 0.004 |
| A2 | 0.70 | 0.90 | 1.00 | 0.027 | 0.035 | 0.039 |
| b | 0.15 | 0.20 | 0.25 | 0.006 | 0.008 | 0.010 |
| C | 0.08 | 0.15 | 0.22 | 0.003 | 0.006 | 0.009 |
| D | 1.80 | 2.00 | 2.20 | 0.070 | 0.078 | 0.086 |
| E | 2.00 | 2.10 | 2.20 | 0.078 | 0.082 | 0.086 |
| E1 | 1.15 | 1.25 | 1.35 | 0.045 | 0.049 | 0.053 |
| e | 0.65 BSC | | | 0.026 BSC | | |
| L | 0.26 | 0.36 | 0.46 | 0.010 | 0.014 | 0.018 |
| L2 | 0.15 BSC | | | 0.006 BSC | | |
| aaa | 0.15 | | | 0.006 | | |
| bbb | 0.30 | | | 0.012 | | |
| ccc | 0.10 | | | 0.004 | | |
| ddd | 0.10 | | | 0.004 | | |

RECOMMENDED SOLDERING FOOTPRINT*

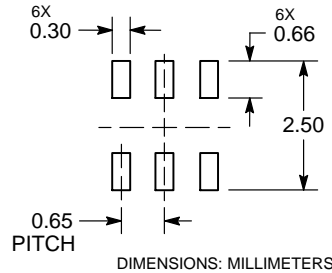

*For additional information on our Pb-Free strategy and soldering details, please download the ON Semiconductor Soldering and Mounting Techniques Reference Manual, SOLDERRM/D.

NCS210, NCS211, NCS212, NCS213, NCS214, NCS215

PACKAGE DIMENSIONS

UQFN10 1.4x1.8, 0.4P CASE 488AT ISSUE A

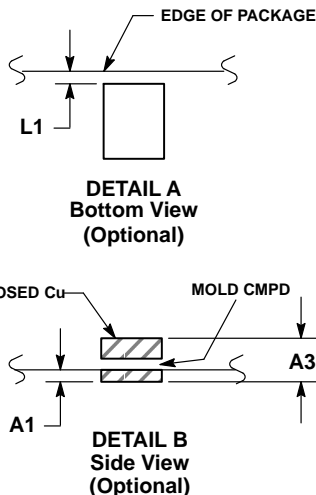
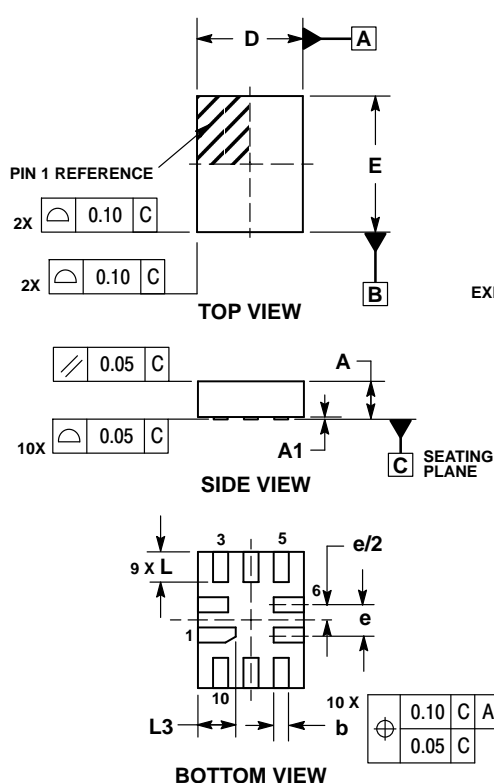

NOTES:

1. DIMENSIONING AND TOLERANCING PER ASME Y14.5M, 1994.
2. CONTROLLING DIMENSION: MILLIMETERS
3. DIMENSION b APPLIES TO PLATED TERMINAL AND IS MEASURED BETWEEN 0.25 AND 0.30 MM FROM TERMINAL.
4. COPLANARITY APPLIES TO THE EXPOSED PAD AS WELL AS THE TERMINALS.

| MILLIMETERS | | |
|-------------|-----------|------|
| DIM | MIN | MAX |
| A | 0.45 | 0.60 |
| A1 | 0.00 | 0.05 |
| A3 | 0.127 REF | |
| b | 0.15 | 0.25 |
| D | 1.40 BSC | |
| E | 1.80 BSC | |
| e | 0.40 BSC | |
| L | 0.30 | 0.50 |
| L1 | 0.00 | 0.15 |
| L3 | 0.40 | 0.60 |

MOUNTING FOOTPRINT

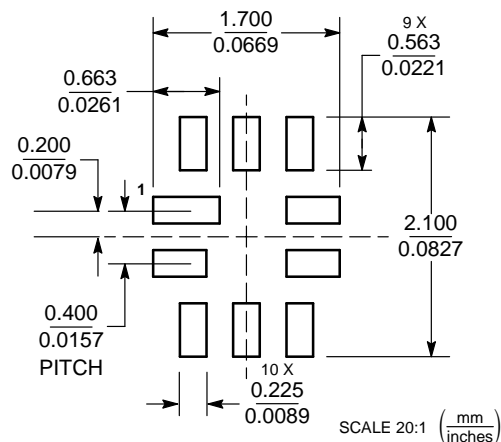

ON Semiconductor and are trademarks of Semiconductor Components Industries, LLC dba ON Semiconductor or its subsidiaries in the United States and/or other countries. ON Semiconductor owns the rights to a number of patents, trademarks, copyrights, trade secrets, and other intellectual property. A listing of ON Semiconductor's product/patent coverage may be accessed at www.onsemi.com/site/pdf/Patent-Marking.pdf. ON Semiconductor reserves the right to make changes without further notice to any products herein. ON Semiconductor makes no warranty, representation or guarantee regarding the suitability of its products for any particular purpose, nor does ON Semiconductor assume any liability arising out of the application or use of any product or circuit, and specifically disclaims any and all liability, including without limitation special, consequential or incidental damages. Buyer is responsible for its products and applications using ON Semiconductor products, including compliance with all laws, regulations and safety requirements or standards, regardless of any support or applications information provided by ON Semiconductor. "Typical" parameters which may be provided in ON Semiconductor data sheets and/or specifications can and do vary in different applications and actual performance may vary over time. All operating parameters, including "Typicals" must be validated for each customer application by customer's technical experts. ON Semiconductor does not convey any license under its patent rights nor the rights of others. ON Semiconductor products are not designed, intended, or authorized for use as a critical component in life support systems or any FDA Class 3 medical devices or medical devices with a same or similar classification in a foreign jurisdiction or any devices intended for implantation in the human body. Should Buyer purchase or use ON Semiconductor products for any such unintended or unauthorized application, Buyer shall indemnify and hold ON Semiconductor and its officers, employees, subsidiaries, affiliates, and distributors harmless against all claims, costs, damages, and expenses, and reasonable attorney fees arising out of, directly or indirectly, any claim of personal injury or death associated with such unintended or unauthorized use, even if such claim alleges that ON Semiconductor was negligent regarding the design or manufacture of the part. ON Semiconductor is an Equal Opportunity/Affirmative Action Employer. This literature is subject to all applicable copyright laws and is not for resale in any manner.

PUBLICATION ORDERING INFORMATION

LITERATURE FULFILLMENT:

Literature Distribution Center for ON Semiconductor
19521 E. 32nd Pkwy, Aurora, Colorado 80011 USA
Phone: 303-675-2175 or 800-344-3860 Toll Free USA/Canada
Fax: 303-675-2176 or 800-344-3867 Toll Free USA/Canada
Email: orderlit@onsemi.com

N. American Technical Support: 800-282-9855 Toll Free
USA/Canada
Europe, Middle East and Africa Technical Support:
Phone: 421 33 790 2910
Japan Customer Focus Center
Phone: 81-3-5817-1050

ON Semiconductor Website: www.onsemi.com

Order Literature: <http://www.onsemi.com/orderlit>

For additional information, please contact your local Sales Representative