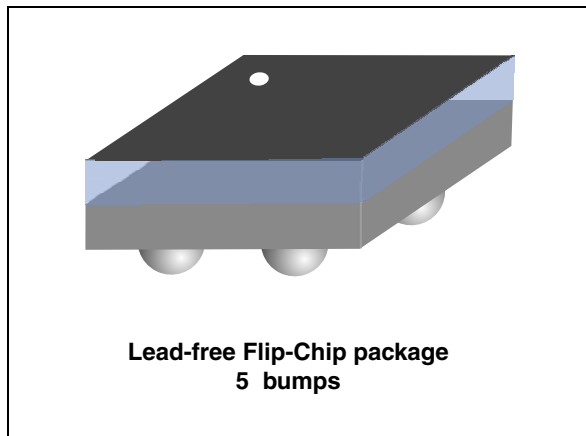


50  $\Omega$  nominal input / conjugate match balun to nRF51822-QFAA/QFAB and nRF51422-QFAA/QFAB with integrated harmonic filter

Datasheet – production data

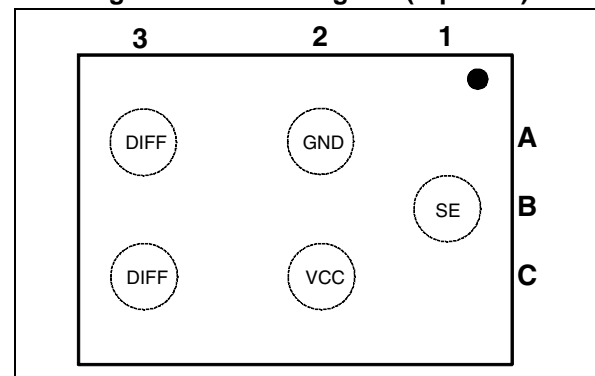


## Description

STMicroelectronics BALF-NRF01D3 is an ultraminiature balun. The BALF-NRF01D3 integrates matching network in a monolithic glass substrate. Matching impedance has been customized for the nRF51822-QFAA/QFAB, and nRF51422-QFAA/QFAB RF transceivers.

The BALF-NRF01D3 uses STMicroelectronics IPD technology on non-conductive glass substrate which optimize RF performance.

Figure 1. Pinout diagram (top view)



## Features

- Low insertion loss
- Low amplitude imbalance
- Low phase imbalance
- Coated Flip-Chip on Glass
- Small footprint: < 1.5 mm<sup>2</sup>

## Benefits

- Very low profile: < 560  $\mu$ m after reflow
- High RF performance
- PCB space saving versus discrete solution
- BOM count reduction
- Efficient manufacturability

## Applications

- 2.45 GHz balun with integrated matching network
- Matching optimized for following chipsets: nRF51822-QFAA/QFAB, and nRF51422-QFAA/QFAB

# 1 Characteristics

**Table 1. Absolute maximum ratings (limiting values)**

Symbol	Parameter	Value			Unit
		Min.	Typ.	Max.	
$P_{IN}$	Input Power $RF_{IN}$			20	dBm
$V_{ESD}$	ESD ratings MIL STD883C (HBM: C = 100 pF, R = 1.5 k $\Omega$ , air discharge)	2000			V
	ESD ratings charge device model (JESD22-C101-C)	500			
	ESD ratings machine model (MM: C = 200 pF, R = 25 $\Omega$ , L = 500 nH)	500			
$T_{OP}$	Operating temperature	-40		+105	$^{\circ}C$

**Table 2. Electrical characteristics ( $T_{amb} = 25^{\circ}C$ )**

Symbol	Parameter	Value			Unit
		Min.	Typ.	Max.	
$Z_{OUT}$	Nominal differential output impedance		conjugate match to: – nRF51822-QFAA/QFAB – nRF51422-QFAA/QFAB		$\Omega$
$Z_{IN}$	Nominal input impedance		50		$\Omega$
F	Frequency range (bandwidth)	2400		2540	
$I_L$	Insertion loss in bandwidth		1.35	1.46	dB
$R_L$	Return loss in bandwidth	16.5	17	17.5	dB
$\Phi_{imb}$	Phase imbalance	4.5	5	5.5	$^{\circ}$
Aimb	Amplitude imbalance	0.15	0.2	0.25	dB
2f0	2nd harmonic filtering		-15	-14	dB
3f0	3rd harmonic filtering		-42	-41	dB

### 1.1 Simulations results ( $T_{amb} = 25\text{ }^{\circ}\text{C}$ )

Figure 2. Insertion loss in band

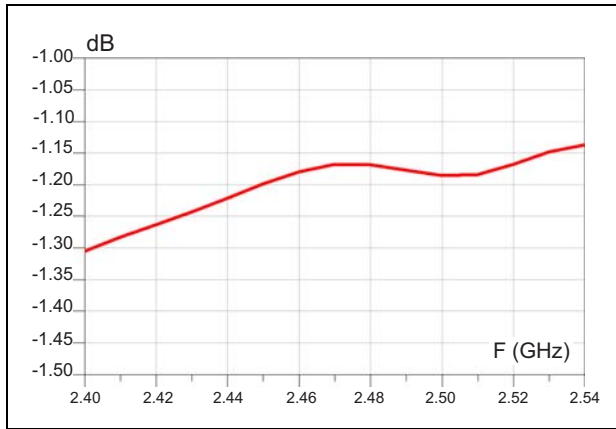


Figure 3. Differential transmission

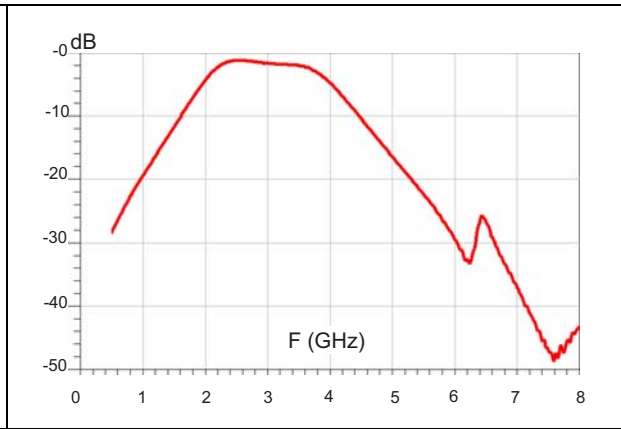


Figure 4. Return loss on SE port

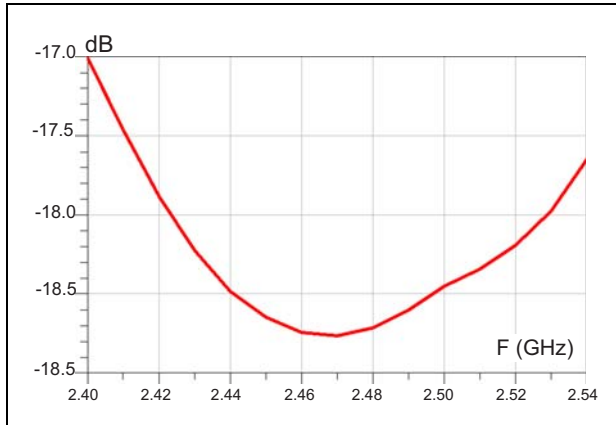


Figure 5. Amplitude imbalance

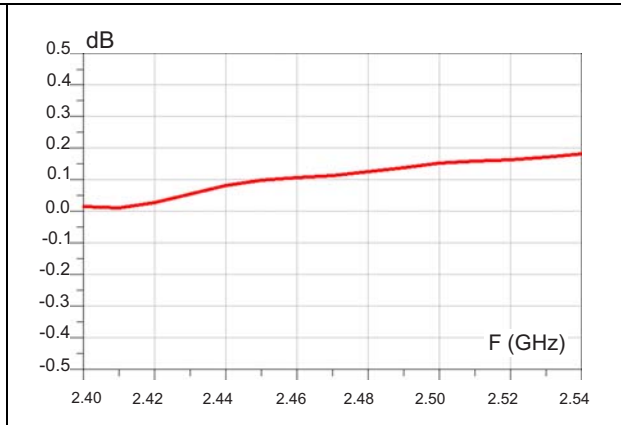


Figure 6. Phase imbalance

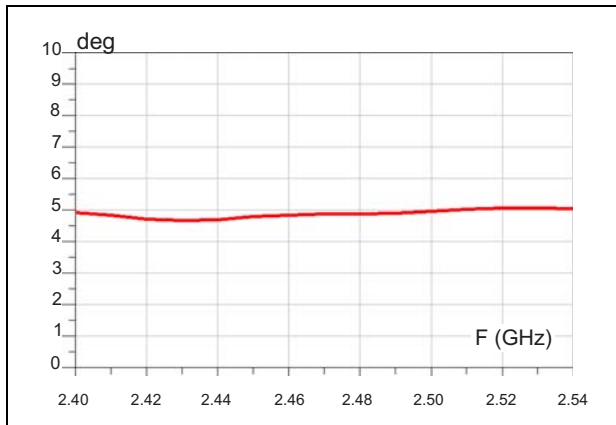


Figure 7. H2 attenuation

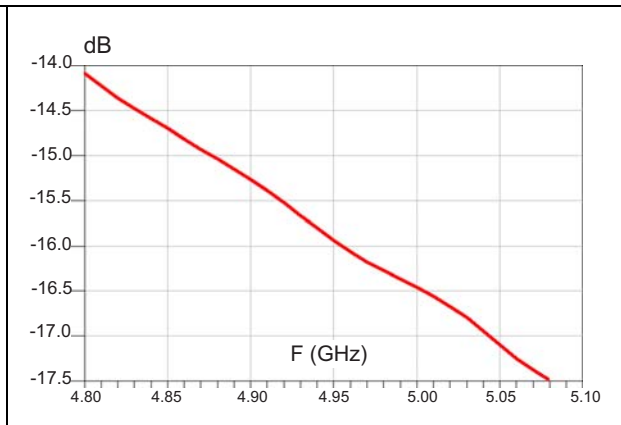


Figure 8. Attenuation in H3

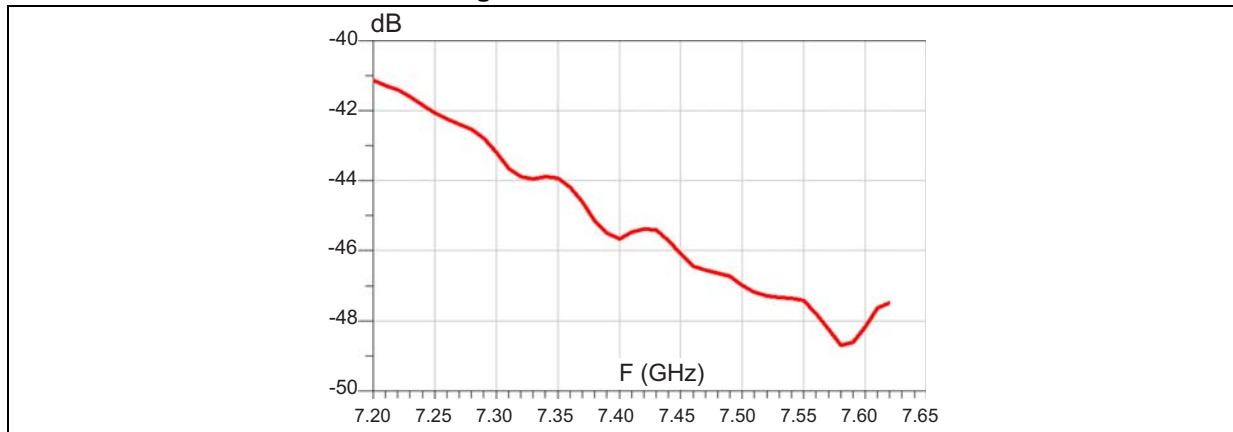


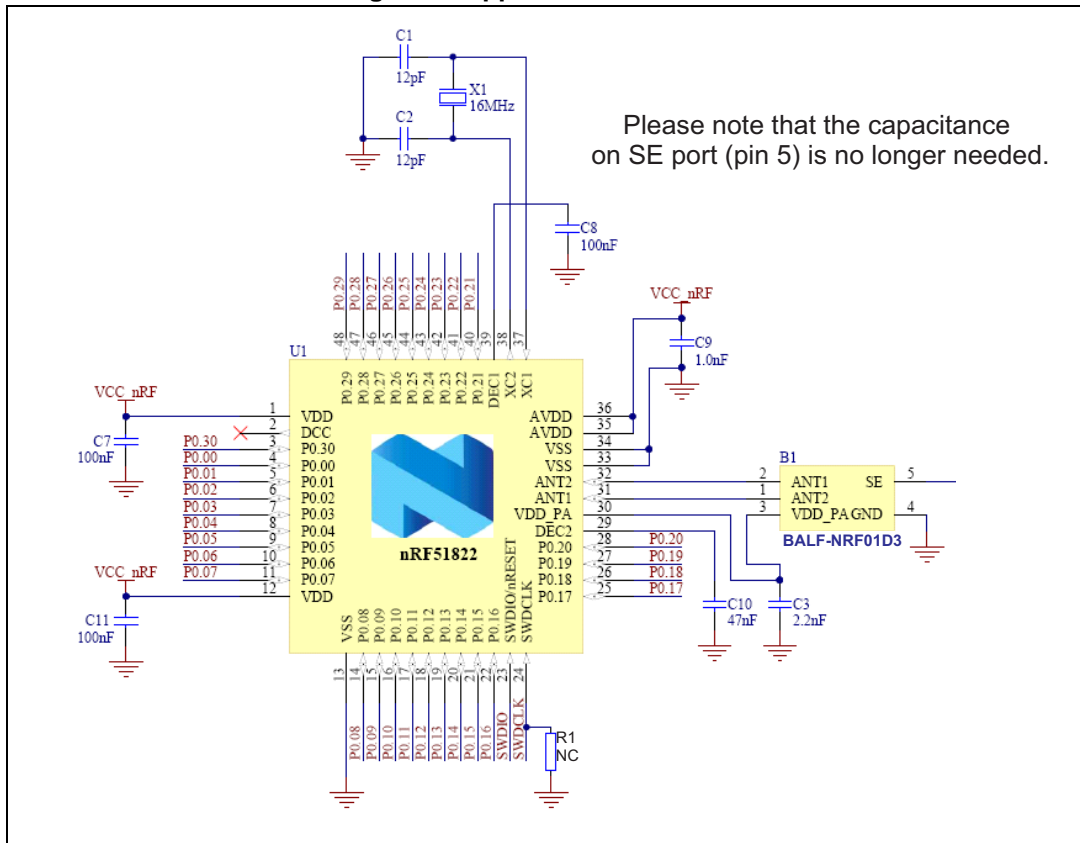
Table 3. Compatibility matrix (nRF51422)

nRF51422 IC revision	Packet/variant	Build code
2	QFAA	DAA
		Ex0
	QFAB	A00

Table 4. Compatibility matrix (nRF51822)

nRF51822 IC revision	Packet/variant	Build code
2	QFAA	FA0
		GC0
		Gx0
	QFAB	Bx0

Figure 9. Application schematic



## 2 Package information

- Epoxy meets UL94, V0
- Lead-free package

In order to meet environmental requirements, ST offers these devices in different grades of ECOPACK® packages, depending on their level of environmental compliance. ECOPACK® specifications, grade definitions and product status are available at: [www.st.com](http://www.st.com). ECOPACK® is an ST trademark.

Figure 10. Package dimensions (top and side view)

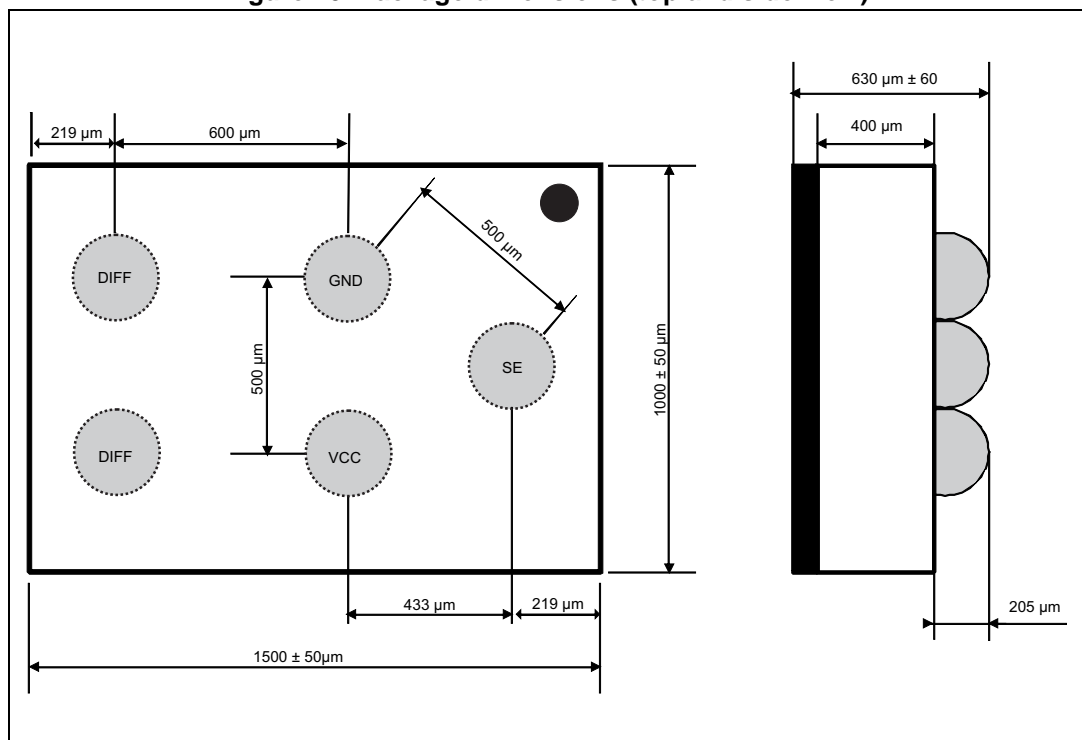


Figure 11. PCB layout recommendation

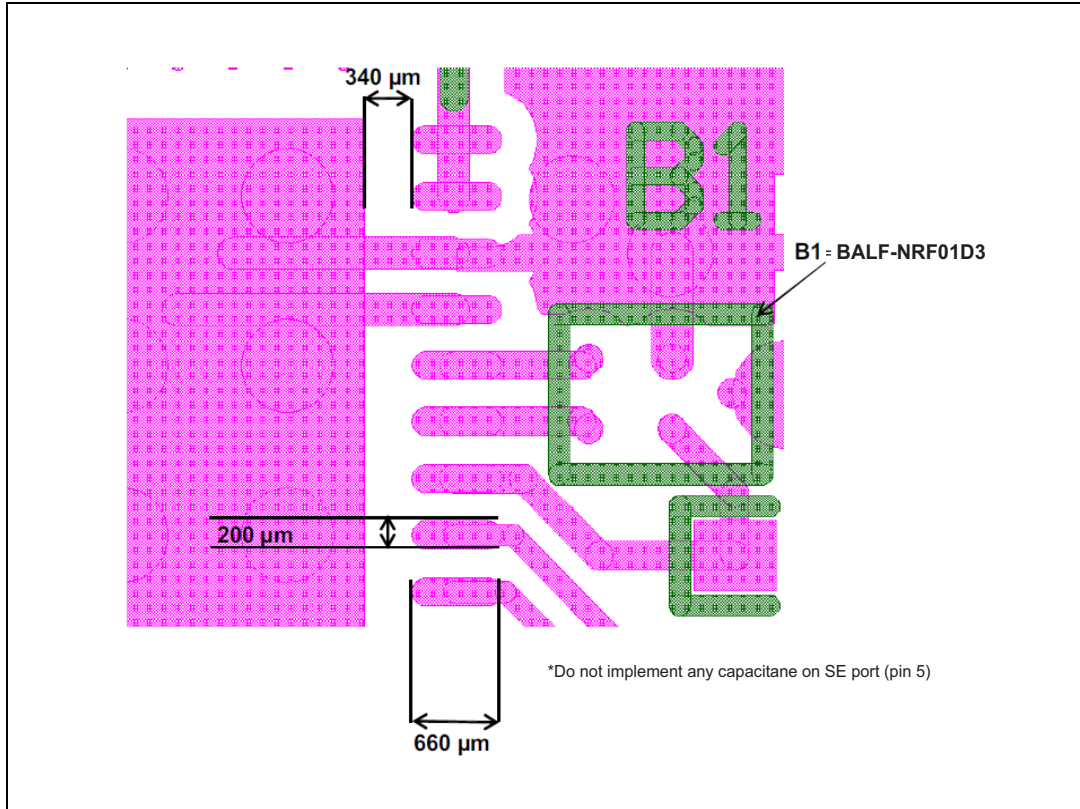


Figure 12. BALF-NRF01D3 position

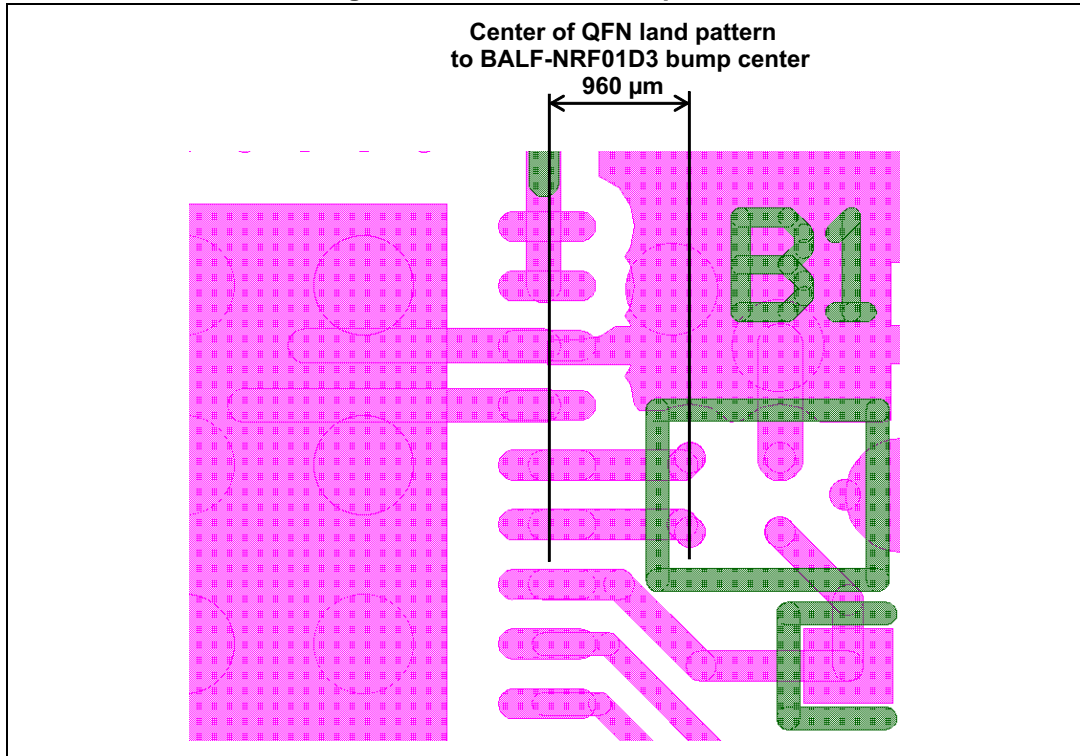


Figure 13. Marking

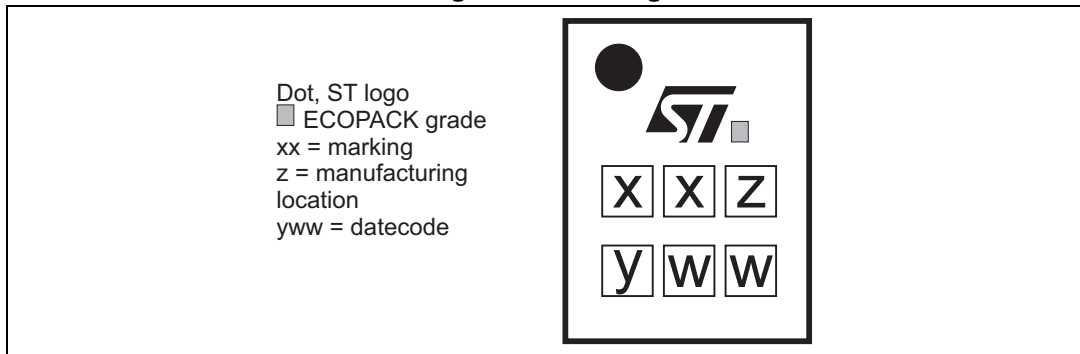
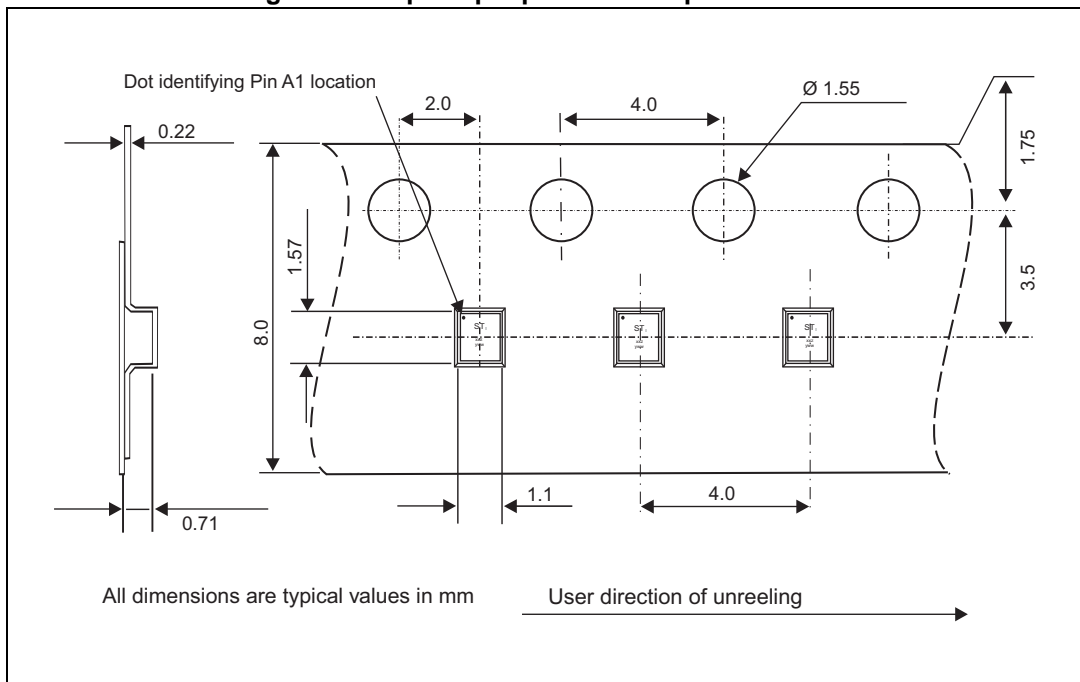


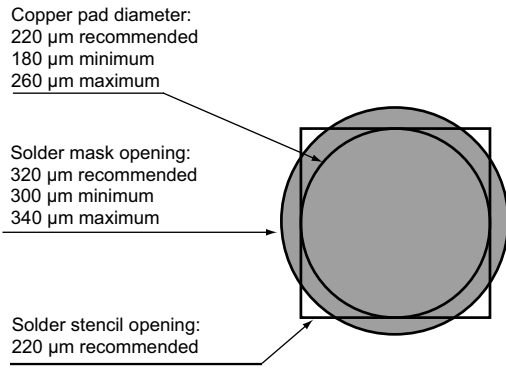
Figure 14. Flip-Chip tape and reel specifications



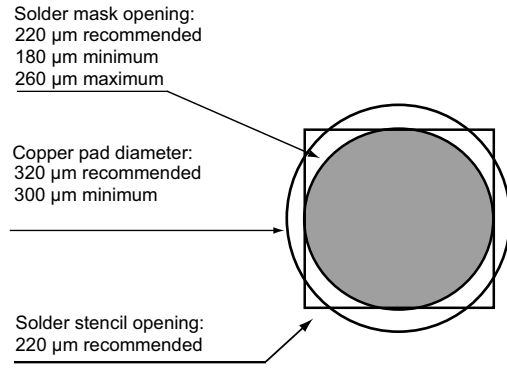
Note: More information is available in the STMicroelectronics Application note: AN2348 Flip-Chip: “Package description and recommendations for use”



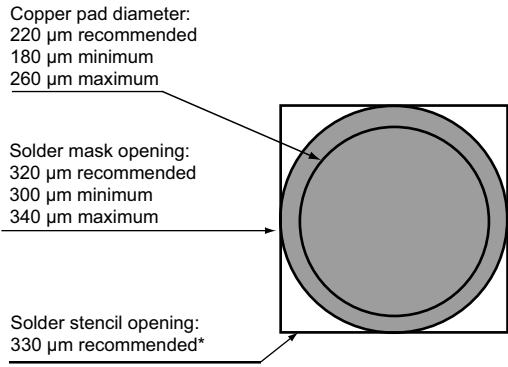
**Figure 15. Footprint - 3 mils stencil - non solder mask defined**



**Figure 16. Footprint - 3 mils stencil - solder mask defined**

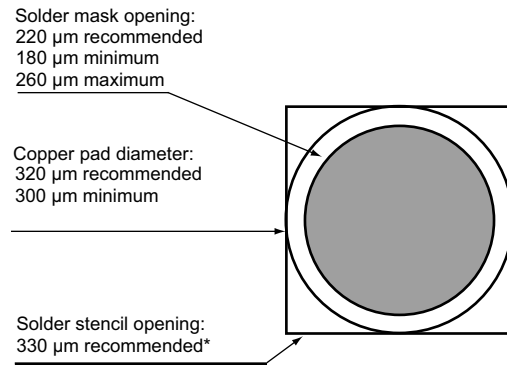


**Figure 17. Footprint - 5 mils stencil - non solder mask defined**



\*depending on paste, it can go down to 270  $\mu\text{m}$

**Figure 18. Footprint - 5 mils stencil - solder mask defined**



\*depending on paste, it can go down to 270  $\mu\text{m}$

### 3 Ordering information

**Table 5. Ordering information**

Order code	Marking	Weight	Base Qty	Delivery mode
BALF-NRF01D3	ST	1.82 mg	5000	Tape and Reel

### 4 Revision history

**Table 6. Document revision history**

Date	Revision	Changes
27-Mar-2014	1	Initial release
04-Jun-2014	2	Updated all curves and added <a href="#">Table 4</a> .
25-Mar-2015	3	Updated cover page and <a href="#">Table 2</a> , <a href="#">Table 3</a> and <a href="#">Table 4</a> .
07-Jul-2015	4	Updated <a href="#">Table 1</a> .

**IMPORTANT NOTICE – PLEASE READ CAREFULLY**

STMicroelectronics NV and its subsidiaries (“ST”) reserve the right to make changes, corrections, enhancements, modifications, and improvements to ST products and/or to this document at any time without notice. Purchasers should obtain the latest relevant information on ST products before placing orders. ST products are sold pursuant to ST’s terms and conditions of sale in place at the time of order acknowledgement.

Purchasers are solely responsible for the choice, selection, and use of ST products and ST assumes no liability for application assistance or the design of Purchasers’ products.

No license, express or implied, to any intellectual property right is granted by ST herein.

Resale of ST products with provisions different from the information set forth herein shall void any warranty granted by ST for such product.

ST and the ST logo are trademarks of ST. All other product or service names are the property of their respective owners.

Information in this document supersedes and replaces information previously supplied in any prior versions of this document.

© 2015 STMicroelectronics – All rights reserved

