

# NB7NPQ7041M

## 3.3 V USB 3.1 Quad Channel / Dual Port Linear Redriver

### Description

The NB7NPQ7041M is a 3.3 V quad channel / dual port linear redriver suitable for USB 3.1 Gen 1 and USB 3.1 Gen 2 applications that supports both 5 Gbps and 10 Gbps data rates. Signal integrity degrades from PCB traces, transmission cables, and inter-symbol interference (ISI). The NB7NPQ7041M compensates for these losses by engaging varying levels of equalization at the input receiver, and flat gain amplification on the output transmitter. The Flat Gain and Equalization are controlled by four level control pins. Each channel has a set of independent control pins to make signal optimization possible.

After power up, the NB7NPQ7041M periodically checks both of the TX output pairs of each port for a receiver connection. When the receiver is detected on both channels, the RX termination becomes enabled of that respective port and is set to perform the redriver function.

The port becomes active once both TX outputs have detected 50-ohm termination, and the NB7NPQ7041M is set to perform the redriver function. Port AB (channels A & B) and port CD (channels C & D) are independent of each other.

The NB7NPQ7041M comes in a small 3.1 x 4.3 mm X2QFN34 package and is specified to operate across the entire industrial temperature range, -40°C to 85°C.

### Features

- 3.3 V  $\pm$  5% Power Supply
- Supports USB 3.1 Gen 1 and USB 3.1 Gen 2 Data Rates
- Automatic Receiver Termination Detection
- Integrated Input and Output Termination
- Independent, Selectable Equalization and Flat Gain
- Hot-Plug Capable
- Flow-through Design for Ease of PCB Layout
- ESD Protection: 4 kV HBM
- Operating Temperature Range: -40°C to 85°C
- Small 3.1 x 4.3 x 0.35 mm X2QFN34 Package
- This is a Pb-Free Device

### Typical Applications

- USB3.1 Type-C and Type-A Signal Routing
- Mobile Phone and Tablet
- Computer and Laptop
- Docking Station and Dongle
- Active Cable, Back Planes
- Gaming Console, Smart T.V., Set-Top Boxes



ON Semiconductor®

[www.onsemi.com](http://www.onsemi.com)

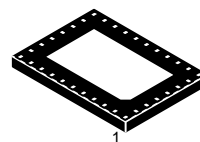

X2QFN34  
CASE 722AL

### MARKING DIAGRAM



7NPQ7041 = Specific Device Code  
A = Assembly Location  
L = Wafer Lot  
Y = Year  
W = Work Week  
▪ = Pb-Free Package

(Note: Microdot may be in either location)

### ORDERING INFORMATION

Device	Package	Shipping†
NB7NPQ7041MMUTWG	X2QFN34 (Pb-Free)	3000 / Tape & Reel

†For information on tape and reel specifications, including part orientation and tape sizes, please refer to our Tape and Reel Packaging Specifications Brochure, BRD8011/D.

# NB7NPQ7041M

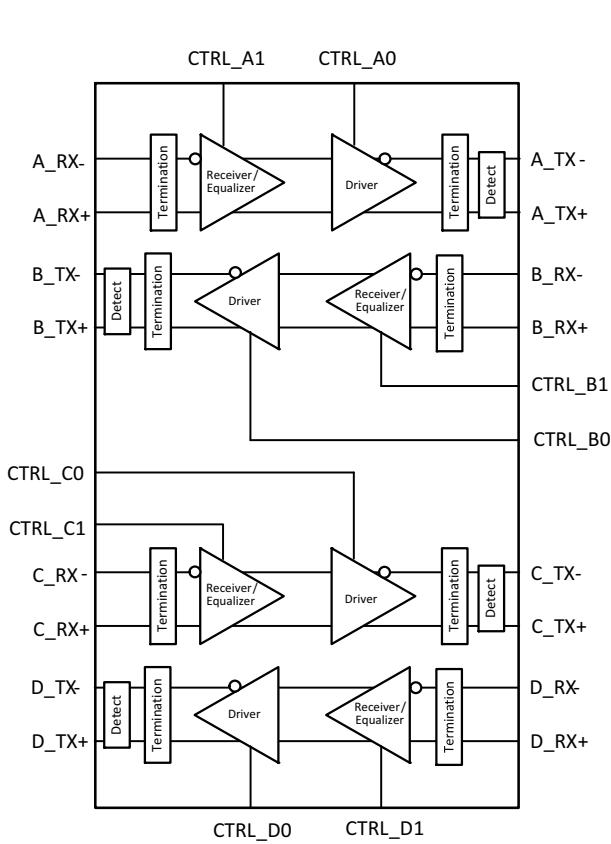

Figure 1. Logic Diagram of NB7NPQ7041M

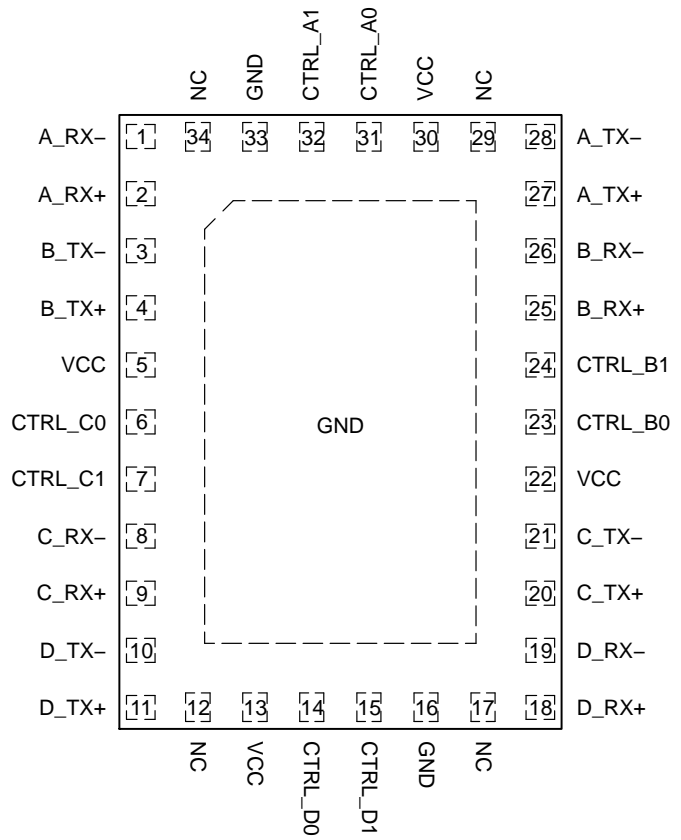

Figure 2. X2QFN34 Package Pinout (Top View)

Table 1. PIN DESCRIPTION

Pin Number	Pin Name	Type	Description
1	A_RX-	DIFF IN	Channel A Differential input pair for 5 / 10 Gbps USB signals. Must be externally AC-coupled.
2	A_RX+		
3	B_TX-	DIFF OUT	Channel B Differential output for 5 / 10 Gbps USB signals. Must be externally AC-coupled.
4	B_TX+		
5	VCC	Power	3.3V power supply. VCC pins must be externally connected to power supply to guarantee proper operation.
6	CTRL_C0	LVC MOS IN	Control pin "C0" for equalization and flat gain on Channel C. 4-state input with integrated pull-up and pull-down resistors. See Table 2.
7	CTRL_C1	LVC MOS IN	Control pin "C1" for equalization and flat gain on Channel C. 4-state input with integrated pull-up and pull-down resistors. See Table 2.
8	C_RX-	DIFF IN	Channel C Differential input pair for 5 / 10 Gbps USB signals. Must be externally AC-coupled.
9	C_RX+		
10	D_TX-	DIFF OUT	Channel D Differential output for 5 / 10 Gbps USB signals. Must be externally AC-coupled.
11	D_TX+		
12	NC		No Connect
13	VCC	Power	3.3V power supply. VCC pins must be externally connected to power supply to guarantee proper operation.
14	CTRL_D0	LVC MOS IN	Control pin "D0" for equalization and flat gain on Channel D. 4-state input with integrated pull-up and pull-down resistors. See Table 2.

# NB7NPQ7041M

**Table 1. PIN DESCRIPTION**

Pin Number	Pin Name	Type	Description
15	CTRL_D1	LVC MOS IN	Control pin "D1" for equalization and flat gain on Channel D. 4-state input with integrated pull-up and pull-down resistors. See Table 2.
16	GND	GND	Reference Ground. GND pins must be externally connected to power supply to guarantee proper operation.
17	NC		No Connect
18	D_RX+	DIFF OUT	Channel D Differential input for 5 / 10 Gbps USB signals. Must be externally AC-coupled.
19	D_RX-		
20	C_TX+	DIFF OUT	Channel C Differential output for 5 / 10 Gbps USB signals. Must be externally AC-coupled.
21	C_TX-		
22	VCC	Power	3.3V power supply. VCC pins must be externally connected to power supply to guarantee proper operation.
23	CTRL_B0	LVC MOS IN	Control pin "B0" for equalization and flat gain on Channel B. 4-state input with integrated pull-up and pull-down resistors. See Table 2.
24	CTRL_B1	LVC MOS IN	Control pin "B1" for equalization and flat gain on Channel B. 4-state input with integrated pull-up and pull-down resistors. See Table 2.
25	B_RX+	DIFF OUT	Channel B Differential input for 5 / 10 Gbps USB signals. Must be externally AC-coupled.
26	B_RX-		
27	A_TX+	DIFF OUT	Channel A Differential output for 5 / 10 Gbps USB signals. Must be externally AC-coupled.
28	A_TX-		
29	NC		No Connect
30	VCC	Power	3.3V power supply. VCC pins must be externally connected to power supply to guarantee proper operation.
31	CTRL_A0	LVC MOS IN	Control pin "A0" for equalization and flat gain on Channel A. 4-state input with integrated pull-up and pull-down resistors. See Table 2.
32	CTRL_A1	LVC MOS IN	Control pin "A1" for equalization and flat gain on Channel A. 4-state input with integrated pull-up and pull-down resistors. See Table 2.
33	GND	GND	Reference Ground. GND pins must be externally connected to power supply to guarantee proper operation.
34	NC		No Connect
EP	GND	GND	Exposed pad (EP). EP on the package bottom is thermally connected to the die for improved heat transfer out of the package. The pad is not electrically connected to the die, but is recommended to be soldered to GND on the PC Board.

# NB7NPQ7041M

## DEVICE CONFIGURATION

**Table 2. CONTROL PIN EFFECTS (Typical Values)**

Setting #	Channel A, Channel C		Channel B, Channel D		EQ Equalization (dB)	FG Flat Gain (dB)
	CTRL_A1 / C1	CTRL_A0 / C0	CTRL_B1 / D1	CTRL_B0 / D0		
1	L	L	L	L	5	0
2	L	R	L	R	7	0
3	L	F	L	F	8	0
4	L	H	L	H	9	0
5	R	L	R	L	10	0
6	R	R	R	R	3	2
7	R	F	R	F	4	2
8	R	H	R	H	5	2
9	F	L	F	L	7	2
10	F	R	F	R	8	2
11 (Default)	F	F	F	F	8	-1
12	F	H	F	H	5	-1
13	H	L	H	L	7	-1
14	H	R	H	R	9	-1
15	H	F	H	F	11	-1
16	H	H	H	H	7	-1

NOTE: Equalization and DC Flat Gain may be set by adjusting the voltage to the control pins. There are 4 specific levels, High "H", Low "L", Rexternal "R" and Float "F". See Table 7 for voltage levels.

**Table 3. ATTRIBUTES**

Parameter		
ESD Protection	Human Body Model Charged Device Model	$\leq 4$ kV $\leq 1.5$ kV
Moisture Sensitivity, Indefinite Time Out of Dry pack (Note 1)		Level 1
Flammability Rating	Oxygen Index: 28 to 34	UL 94 V-O @ 0.125 in
Transistor Count		40,660
Meets or exceeds JEDEC Spec EIA/JESD78 IC Latch-up Test		

1. For additional information, see Application Note AND8003/D.

**Table 4. ABSOLUTE MAXIMUM RATINGS** Over operating free-air temperature range (unless otherwise noted)

Parameter	Description	Min	Max	Unit
Supply Voltage (Note 2)	V <sub>CC</sub>	-0.5	4.6	V
Voltage range at any input or output terminal	Differential I/O	-0.5	1.89	V
	LVC MOS inputs	-0.5	V <sub>CC</sub> + 0.5	V
Storage Temperature Range, T <sub>SG</sub>		-65	150	°C
Maximum Junction Temperature, T <sub>J</sub>			125	°C
Operating Ambient Temperature Range, T <sub>A</sub>		-40	85	°C
Junction-to-Ambient Thermal Resistance @ 500 lfm, $\theta_{JA}$ (Note 3)			34	°C/W
Wave Solder, Pb-Free, T <sub>SOL</sub>			265	°C

Stresses exceeding those listed in the Maximum Ratings table may damage the device. If any of these limits are exceeded, device functionality should not be assumed, damage may occur and reliability may be affected.

2. All voltage values are with respect to the GND terminals.

3. JEDEC standard multilayer board - 2S2P (2 signal, 2 power).

# NB7NPQ7041M

**Table 5. RECOMMENDED OPERATING CONDITIONS** Over operating free-air temperature range (unless otherwise noted)

Parameter	Description	Min	Nom	Max	Unit
V <sub>CC</sub>	Main power supply	3.135	3.3	3.465	V
T <sub>A</sub>	Operating free-air temperature	-40		+85	°C
C <sub>AC</sub>	AC coupling capacitor (TX)	75	100	265	nF

Functional operation above the stresses listed in the Recommended Operating Ranges is not implied. Extended exposure to stresses beyond the Recommended Operating Ranges limits may affect device reliability.

**Table 6. POWER SUPPLY CHARACTERISTICS**

Parameter		Test Conditions	Min	Typ (Note 4)	Max	Unit
I <sub>CC</sub>	Active	Link in U0 with Super Speed Plus data transmission		260		mA
	U2/U3	Link in U2 or U3 power saving state		2		mA
	No USB Connection	No connection state, termination disabled		560		µA

4. TYP values use V<sub>CC</sub> = 3.3 V, T<sub>A</sub> = 25°C

**Table 7. LVCMOS CONTROL PIN CHARACTERISTICS** 4-State LVCMOS Inputs (CTRL\_A0, CTRL\_A1, CTRL\_B0, CTRL\_B1)

Parameter		Test Conditions	Min	Typ	Max	Unit
V <sub>IL</sub>	DC Input Setting "L"	Input pin connected to GND		GND	0.1*V <sub>CC</sub>	V
V <sub>IR</sub>	DC Input Setting "R"	A specified resistor must be applied between pin and GND	0.23*V <sub>CC</sub>	0.33*V <sub>CC</sub>	0.43*V <sub>CC</sub>	V
V <sub>IF</sub>	DC Input Setting "F"	Input pin is left floating	0.56*V <sub>CC</sub>	0.66*V <sub>CC</sub>	0.76*V <sub>CC</sub>	V
V <sub>IH</sub>	DC Input Setting "H"	Input pin connected to V <sub>CC</sub>		V <sub>CC</sub>		V
R <sub>PU</sub>	Internal pull-up resistance			100		kΩ
R <sub>PD</sub>	Internal pull-down resistance			200		kΩ
I <sub>IH</sub>	High-level input current	V <sub>IN</sub> = 3.465 V, V <sub>CC</sub> = 3.465 V			25	µA
I <sub>IL</sub>	Low-level input current	V <sub>IN</sub> = GND, V <sub>CC</sub> = 3.465 V	-45			µA
R <sub>ext</sub>	External Resistor for input setting "R"			68		kΩ

5. Floating refers to a pin left in an open state, with no external connections.

**Table 8. RECEIVER AC/DC CHARACTERISTICS** Over operating free-air temperature range (unless otherwise noted)

Parameter		Test Conditions	Min	Typ	Max	Unit
V <sub>RX-DIFF-pp</sub>	Input differential voltage swing	AC-coupled, peak-to-peak	100		1200	mV <sub>PP</sub>
V <sub>RX-CM</sub>	Common-mode voltage bias in the receiver (DC)			V <sub>CC</sub>		V
Z <sub>RX-DIFF</sub>	Differential input resistance (DC)	Present after an USB device is detected on TX+/TX-	80	100	120	Ω
Z <sub>RX-CM</sub>	Common-mode input resistance (DC)	Present after an USB device is detected on TX+/TX-	20	25	30	Ω
Z <sub>RX-HIGH-IMP</sub>	Common-mode input resistance with termination disabled (DC)	Present when no USB device is detected on TX+	25	190		kΩ
V <sub>TH-LFPS-pp</sub>	Low Frequency Periodic Signaling (LFPS) Detect Threshold	Output voltage is considered squelched below this threshold voltage.	100	200	300	mV <sub>PP</sub>

Product parametric performance is indicated in the Electrical Characteristics for the listed test conditions, unless otherwise noted. Product performance may not be indicated by the Electrical Characteristics if operated under different conditions.

# NB7NPQ7041M

**Table 9. TRANSMITTER AC/DC CHARACTERISTICS** Over operating free-air temperature range (unless otherwise noted)

Parameter	Test Conditions	Min	Typ	Max	Unit	
$V_{sw\_100M}$	-1 dB compression point Output swing at 100 MHz		1200		mV <sub>PPd</sub>	
$V_{sw\_5G}$	-1 dB compression point Output swing at 5 GHz		900		mV <sub>PPd</sub>	
$C_{TX}$	TX input capacitance to GND		1.25		pF	
$Z_{TX-DIFF}$	Differential output impedance (DC)	Present after an USB device is detected on TX+/TX-	80	100	120	$\Omega$
$Z_{TX-CM}$	Common-mode output impedance (DC)	Present after an USB device is detected on TX+/TX-	20	25	30	$\Omega$
$I_{TX-SC}$	TX short circuit current	TX+ or TX- shorted to GND		40		mA
$V_{TX-CM}$	Common-mode voltage bias in the transmitter (DC)	100 mV, 50 MHz, 5 Gbps and 10 Gbps, PRBS 2 <sup>7</sup>		$V_{CC}-0.8$	$V_{CC}$	V
$V_{TX-CM-ACpp}$	AC common-mode peak-to-peak voltage swing in active mode	Within U0 and at 50 MHz (LFPS)			100	mV <sub>PP</sub>
$V_{TX-IDLE-DIFF-ACpp}$	Differential voltage swing during electrical idle	Tested with a high-pass filter	0		10	mV <sub>PP</sub>
$V_{TX-RXDET}$	Voltage change to allow receiver detect	The change in voltage that triggers detection of a receiver.		325	600	mV
$t_R, t_F$	Output rise, fall time	20% – 80% of differential voltage measured 1 inch from the output pin,		35		ps
$t_{RF-MM}$	Output rise, Fall time mismatch	20% – 80% of differential voltage measured 1 inch from the output pin			10	ps
$t_{diff-LH}, t_{diff-HL}$	Differential propagation delay	Propagation delay between 50% level at input and output		110		ps
$t_{idleExit}$	Idle exit time	50 MHz clock signal, EQ an FG setting "11 (Default)"		10		ns
$t_{idleEntry}$	Idle entry time	50 MHz clock signal, EQ an FG setting "11 (Default)"		60		ps

**Table 10. TIMING AND JITTER CHARACTERISTICS**

Parameter	Test Conditions	Min	Typ	Max	Unit
-----------	-----------------	-----	-----	-----	------

**TIMING**

$t_{READY}$	Time from power applied until RX termination is enabled	Apply 0 V to $V_{CC}$ , connect USB termination to TX $\pm$ , apply 3.3 V to $V_{CC}$ , and measure when $Z_{RX-DIFF}$ is enabled		110		ms
-------------	---	---	--	-----	--	----

**JITTER FOR 5 Gbps**

$T_{JTX-EYE}$	Total jitter (Notes 6, 7)	EQ = 5 dB, FG = 0 dB, EQ and FG Setting "LL"		0.20		UI
$D_{JTX}$	Deterministic jitter (Note 7)			0.10		UI
$R_{JTX}$	Random jitter (Note 7)			0.07		UI

**JITTER FOR 10 Gbps**

$T_{JTX-EYE}$	Total jitter (Notes 6, 7)	EQ = 5 dB, FG = 0 dB, EQ and FG Setting "LL"		0.22		UI
$D_{JTX}$	Deterministic jitter (Note 7)			0.08		UI
$R_{JTX}$	Random jitter (Note 7)			0.06		UI

6. Includes RJ at 10<sup>-12</sup>.

7. Measured at the ends of reference channel with a K28.5 pattern, VID = 1000 mVpp, -3.5 dB de-emphasis from source.

8. 5 Gbps, UI = 200 ps for 10 Gbps, UI = 100 ps

# NB7NPQ7041M

## PARAMETER MEASUREMENT DIAGRAMS

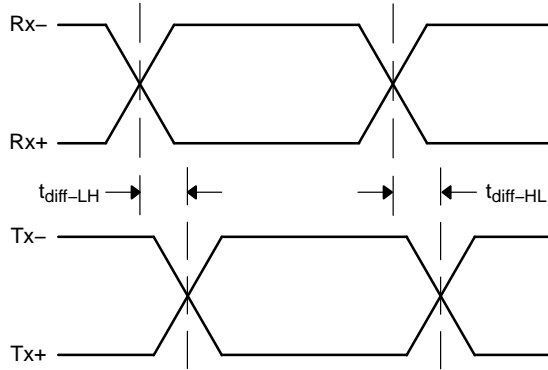

Figure 3. Propagation Delay

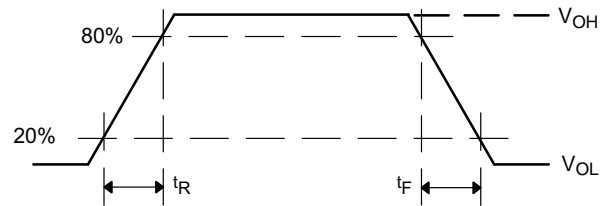

Figure 4. Output Rise and Fall Times

## APPLICATION GUIDELINES

### LFPS Compliance Testing

As part of USB 3.1 compliance test, the host or peripheral must transmit a LFPS signal that adheres to the spec parameters. The NB7NPQ7041M is tested as a part of a USB compliant system to ensure that it maintains compliance while increasing system performance.

### LFPS Functionality

USB 3.1, Gen1 and Gen2 use Low Frequency Periodic Signaling.

(LFPS) to implement functions like exiting low-power modes, performing warm resets and providing link training between host and peripheral devices. LFPS signaling consists of bursts of frequencies ranging between 10 to 50 MHz and can have specific burst lengths or repeat rates.

### Ping.LFPS for TX Compliance

During the transmitter compliance, the system under test must transmit certain compliance patterns as defined by the USB-IF. In order to toggle through these patterns for various tests, the receiver must receive a ping.LFPS signal from either the test suite or a separate pattern generator. The standard signal comprises of a single burst period of 100 ns at 20 MHz.

### Control Pin Settings

Control pins A1, A0, B1, and B0 control the Flat Gain and the Equalization of channels A and B and control pins C1, C0, D1, and D0 control the Flat Gain and the Equalization of channels C and D of the NB7NPQ7041M Device.

The Float (Default) Setting “F” can be set by leaving the control pins in a floating state. The Redriver will internally

bias the control pins to the correct voltage to achieve this if the pin is not connected to a voltage source. The low Setting “L” is set by pulling the control pin to ground. Likewise the high setting “H” is set by pulling the pin high to VCC. The Rexternal setting can be set by adding a 68-K resistor from the control pin to ground. This will bias the Redriver internal voltage to 33% of VCC.

### Linear Equalization

The linear equalization that the NB7NPQ7041M provides compensates for losses that occur naturally along board traces and cable lines. Linear Equalization boosts high frequencies and lower frequencies linearly so when transmitting at varying frequencies, the voltage amplitude will remain consistent. This compensation electrically counters losses and allows for longer traces to be possible when routing.

### DC Flat Gain

DC flat gain equally boosts high and low frequency signals, and is essential for countering low frequency losses.

DC flat gain can also be used to simulate a higher input signal from a USB Controller. If a USB controller can only provide 800 mV differential to a receiver, it can be boosted to 1128 mV using 3 dB of flat gain.

### Total Gain

When using Flat Gain with Equalization in a USB application it is important to make sure that the total voltage does not exceed 1200 mV. Total gain can be calculated by adding the EQ gain to the FG.

# NB7NPQ7041M

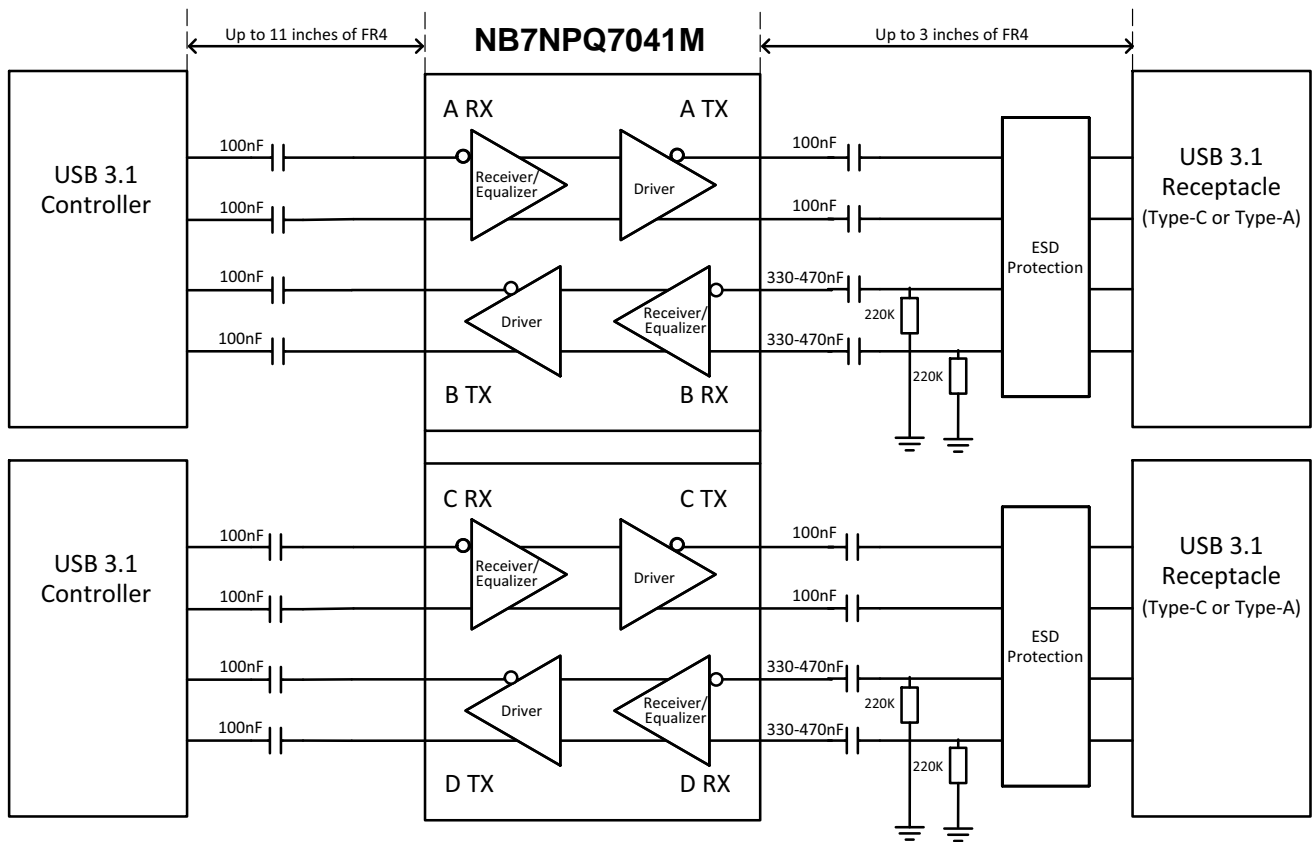

Figure 5. Typical Application

Table 11. DESIGN REQUIREMENTS

Design Parameter	Value
Supply Voltage	3.3 V nominal, (3.135 V to 3.465 V)
Operation Mode (Control Pin Selection)	Floating by Default, adjust for application losses See Table 2
AC Coupling Capacitors (TX)	100 nF nominal, 75 nF to 265 nF, see Figure 5
R <sub>external</sub>	68 kΩ, ±10%
RX Pull Down Resistors at Receptacle	200 KΩ to 220 KΩ
Power Supply Capacitors	100 nF to GND close to each Vcc pin, and 10 μF to GND on the Vcc plane
Trace loss of FR4 before NB7NPQ7021M	Up to 11 inches
Trace loss of FR4 after NB7NPQ7021M	Up To 3 inches. Keep as short as possible for best performance.
Linear Range at 5 GHz	900 mV differential
DC Flat Gain Options	-1 dB, 0 dB, 2 dB
Equalization Options	3 to 11 dB
Differential Trace Impedance	90 Ω ±10%

9. Trace loss of FR4 was estimated to have 1 dB of loss per 1 inch of FR4 length with matched impedance and no VIAS.

### Typical Layout Practices

- RX and TX pairs should maintain as close to a 90 Ω differential impedance as possible.
- Limit the number of vias used on each data line. It is suggested that 2 or fewer are used.
- Traces should be routed as straight and symmetric as possible.

- RX and TX differential pairs should always be placed and routed on the same layer directly above a ground plane. This will help reduce EMI and noise on the data lines.
- Routing angles should be obtuse angles and kept to 135 degrees or larger.
- To minimize crosstalk, TX and RX data lines should be kept away from other high speed signals.



# MECHANICAL CASE OUTLINE

## PACKAGE DIMENSIONS

ON Semiconductor®



**X2QFN34 3.1x4.3, 0.4P**  
CASE 722AL  
ISSUE O

DATE 02 MAY 2017

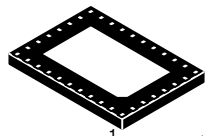

SCALE 4:1

PIN ONE REFERENCE

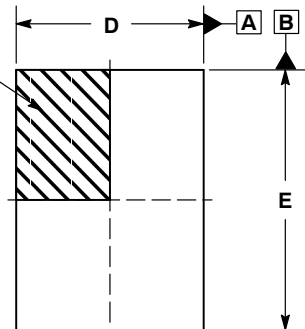

TOP VIEW

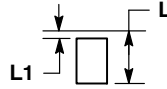

DETAIL A

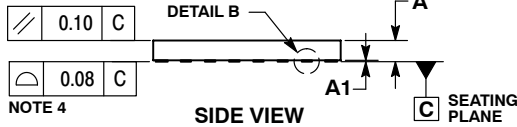

SIDE VIEW

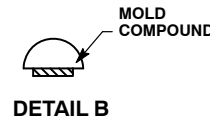

DETAIL B

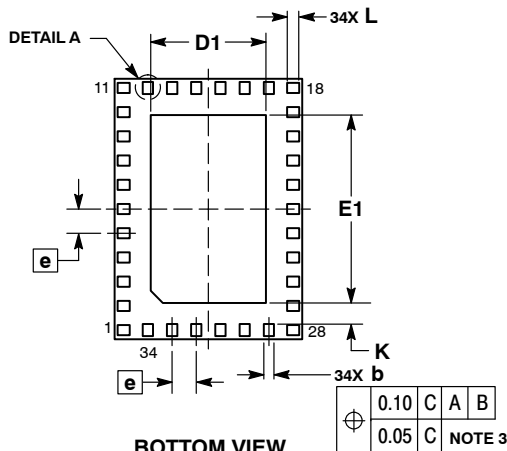

BOTTOM VIEW

RECOMMENDED  
SOLDERING FOOTPRINT

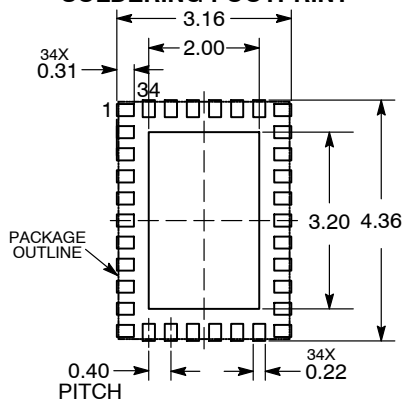

DIMENSIONS: MILLIMETERS

NOTES:

1. DIMENSIONING AND TOLERANCING PER ASME Y14.5M, 1994.
2. CONTROLLING DIMENSION: MILLIMETERS.
3. DIMENSION b APPLIES TO PLATED TERMINAL AND IS MEASURED BETWEEN 0.20 AND 0.25 MM FROM THE TERMINAL TIP.
4. COPLANARITY APPLIES TO THE EXPOSED PAD AS WELL AS THE PLATED TERMINALS.

MILLIMETERS			
DIM	MIN	NOM	MAX
A	0.30	0.35	0.40
A1	---	---	0.05
b	0.12	0.17	0.22
D	3.00	3.10	3.20
D1	1.80	1.90	2.00
E	4.20	4.30	4.40
E1	3.00	3.10	3.20
e	0.40 BSC		
K	0.35 REF		
L	0.20	0.25	0.30
L1	0.05 REF		

GENERIC  
MARKING DIAGRAM\*

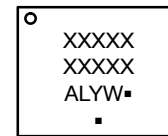

- XXXXX = Specific Device Code
- A = Assembly Location
- L = Wafer Lot
- Y = Year
- W = Work Week
- = Pb-Free Package

(Note: Microdot may be in either location)

\*This information is generic. Please refer to device data sheet for actual part marking. Pb-Free indicator, "G" or microdot "▪", may or may not be present. Some products may not follow the Generic Marking.

<b>DOCUMENT NUMBER:</b>	<b>98AON63532G</b>	Electronic versions are uncontrolled except when accessed directly from the Document Repository. Printed versions are uncontrolled except when stamped "CONTROLLED COPY" in red.
<b>DESCRIPTION:</b>	<b>X2QFN34 3.1X4.3, 0.4P</b>	<b>PAGE 1 OF 1</b>

ON Semiconductor and are trademarks of Semiconductor Components Industries, LLC dba ON Semiconductor or its subsidiaries in the United States and/or other countries. ON Semiconductor reserves the right to make changes without further notice to any products herein. ON Semiconductor makes no warranty, representation or guarantee regarding the suitability of its products for any particular purpose, nor does ON Semiconductor assume any liability arising out of the application or use of any product or circuit, and specifically disclaims any and all liability, including without limitation special, consequential or incidental damages. ON Semiconductor does not convey any license under its patent rights nor the rights of others.

ON Semiconductor and  are trademarks of Semiconductor Components Industries, LLC dba ON Semiconductor or its subsidiaries in the United States and/or other countries. ON Semiconductor owns the rights to a number of patents, trademarks, copyrights, trade secrets, and other intellectual property. A listing of ON Semiconductor's product/patent coverage may be accessed at [www.onsemi.com/site/pdf/Patent-Marking.pdf](http://www.onsemi.com/site/pdf/Patent-Marking.pdf). ON Semiconductor reserves the right to make changes without further notice to any products herein. ON Semiconductor makes no warranty, representation or guarantee regarding the suitability of its products for any particular purpose, nor does ON Semiconductor assume any liability arising out of the application or use of any product or circuit, and specifically disclaims any and all liability, including without limitation special, consequential or incidental damages. Buyer is responsible for its products and applications using ON Semiconductor products, including compliance with all laws, regulations and safety requirements or standards, regardless of any support or applications information provided by ON Semiconductor. "Typical" parameters which may be provided in ON Semiconductor data sheets and/or specifications can and do vary in different applications and actual performance may vary over time. All operating parameters, including "Typicals" must be validated for each customer application by customer's technical experts. ON Semiconductor does not convey any license under its patent rights nor the rights of others. ON Semiconductor products are not designed, intended, or authorized for use as a critical component in life support systems or any FDA Class 3 medical devices or medical devices with a same or similar classification in a foreign jurisdiction or any devices intended for implantation in the human body. Should Buyer purchase or use ON Semiconductor products for any such unintended or unauthorized application, Buyer shall indemnify and hold ON Semiconductor and its officers, employees, subsidiaries, affiliates, and distributors harmless against all claims, costs, damages, and expenses, and reasonable attorney fees arising out of, directly or indirectly, any claim of personal injury or death associated with such unintended or unauthorized use, even if such claim alleges that ON Semiconductor was negligent regarding the design or manufacture of the part. ON Semiconductor is an Equal Opportunity/Affirmative Action Employer. This literature is subject to all applicable copyright laws and is not for resale in any manner.

## PUBLICATION ORDERING INFORMATION

### LITERATURE FULFILLMENT:

Email Requests to: [orderlit@onsemi.com](mailto:orderlit@onsemi.com)

ON Semiconductor Website: [www.onsemi.com](http://www.onsemi.com)

### TECHNICAL SUPPORT

North American Technical Support:  
Voice Mail: 1 800-282-9855 Toll Free USA/Canada  
Phone: 011 421 33 790 2910

Europe, Middle East and Africa Technical Support:

Phone: 00421 33 790 2910

For additional information, please contact your local Sales Representative

