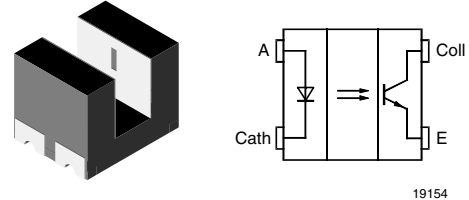


Subminiature Transmissive Optical Sensor with Phototransistor Output, RoHS Compliant, Released for Lead (Pb)-free Solder Process

Description

The TCPT1200 is a compact transmissive sensor that includes an infrared emitter and phototransistor detector, located face-to-face on the optical axes in a surface mount package.



Features

- Package type: Surface mount
- Detector type: Phototransistor
- Dimensions:
L 5 mm x W 4 mm x H 4 mm
- Gap: 2 mm
- Aperture: 0.3 mm
- Typical output current under test: $I_C = 0.5 \text{ mA}$
- Emitter wavelength: 950 nm
- Lead (Pb)-free soldering released
- Lead (Pb)-free component in accordance with RoHS 2002/95/EC and WEEE 2002/96/EC
- Minimum order quantity: 2000 pcs, 2000 pcs/reel



Applications

- Accurate position sensor for encoder
- Detection of motion direction
- Computer mouse and trackballs

Absolute Maximum Ratings

$T_{amb} = 25 \text{ }^\circ\text{C}$, unless otherwise specified

Coupler

Parameter	Test condition	Symbol	Value	Unit
Power dissipation	$T_{amb} \leq 25 \text{ }^\circ\text{C}$	P	150	mW
Ambient temperature range		T_{amb}	- 40 to + 85	$^\circ\text{C}$
Storage temperature range		T_{stg}	- 40 to + 100	$^\circ\text{C}$
Soldering temperature	in accordance with fig. 13	T_{sd}	260	$^\circ\text{C}$

Input (Emitter)

Parameter	Test condition	Symbol	Value	Unit
Reverse voltage		V_R	5	V
Forward current		I_F	25	mA
Pulse forward current	$t_p = 0.1 \text{ ms}; t_p / T = 0.01$	I_{FP}	100	mA
Power dissipation	$T_{amb} \leq 25 \text{ }^\circ\text{C}$	P_V	75	mW

Output (Detector)

Parameter	Test condition	Symbol	Value	Unit
Collector emitter voltage		V_{CEO}	70	V
Emitter collector voltage		V_{ECO}	7	V
Collector current		I_C	20	mA
Power dissipation	$T_{amb} \leq 25 \text{ }^\circ\text{C}$	P_V	75	mW

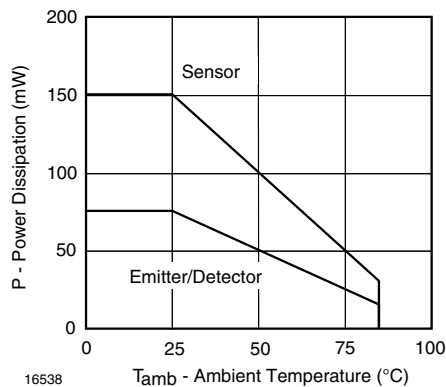


Figure 1. Power Dissipation Limit vs. Ambient Temperature

Electrical Characteristics

T_{amb} = 25 °C, unless otherwise specified

Coupler

Parameter	Test condition	Symbol	Min	Typ.	Max	Unit
Collector current	V _{CE} = 5 V, I _F = 15 mA	I _C	300	500		μA
Collector emitter saturation voltage	I _F = 15 mA, I _C = 0.05 mA	V _{CEsat}			0.4	V

Input (Emitter)

Parameter	Test condition	Symbol	Min	Typ.	Max	Unit
Forward voltage	I _F = 15 mA	V _F		1.2	1.5	V
Reverse current	V _R = 5 V	I _R			10	μA
Junction capacitance	V _R = 0 V, f = 1 MHz	C _j		50		pF

Output (Detector)

Parameter	Test condition	Symbol	Min	Typ.	Max	Unit
Collector emitter voltage	I _C = 1 mA	V _{CEO}	70			V
Emitter collector voltage	I _E = 100 μA	V _{ECO}	7			V
Collector dark current	V _{CE} = 25 V, I _F = 0, E = 0	I _{CEO}		10	100	nA

Switching Characteristics

Parameter	Test condition	Symbol	Min	Typ.	Max	Unit
Rise time	I _C = 0.3 mA, V _{CE} = 5 V, R _L = 1000 Ω (see figure 3)	t _r		20.0	150	μs
Fall time	I _C = 0.3 mA, V _{CE} = 5 V, R _L = 1000 Ω (see figure 3)	t _f		30.0	150	μs

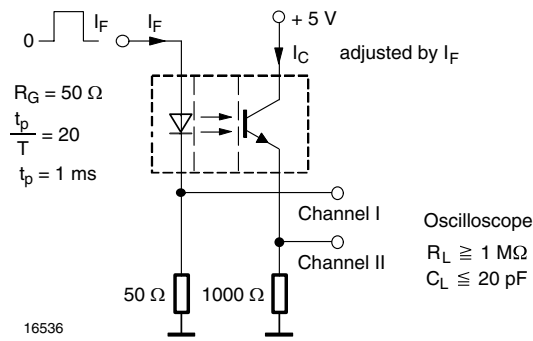


Figure 2. Test Circuit for t_r and t_f

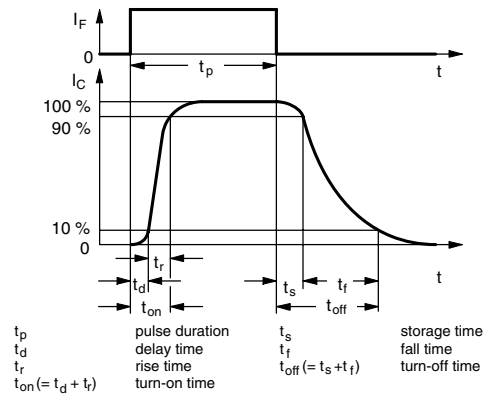


Figure 3. Switching Times

Typical Characteristics

$T_{amb} = 25\text{ }^{\circ}\text{C}$, unless otherwise specified

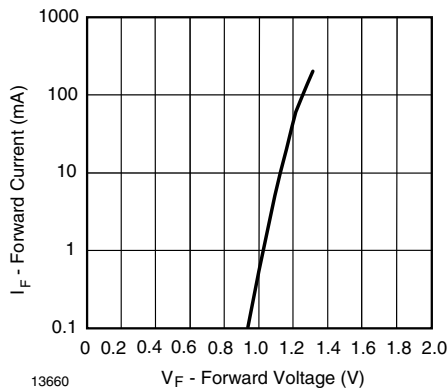


Figure 4. Forward Current vs. Forward Voltage

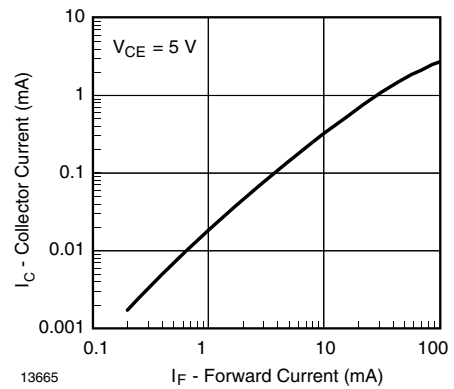


Figure 6. Collector Current vs. Forward Current

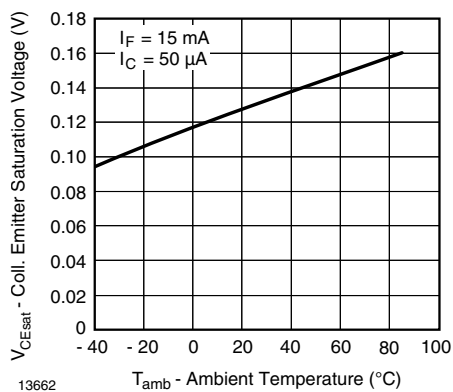


Figure 5. Collector Emitter Saturation Voltage vs. Ambient Temperature

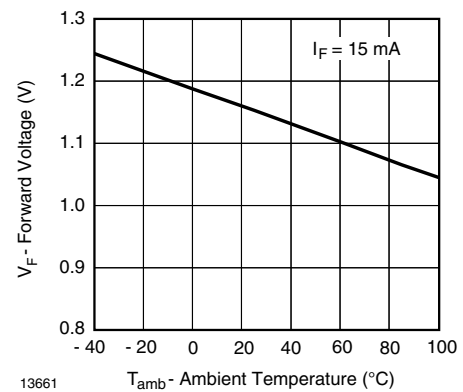


Figure 7. Forward Voltage vs. Ambient Temperature

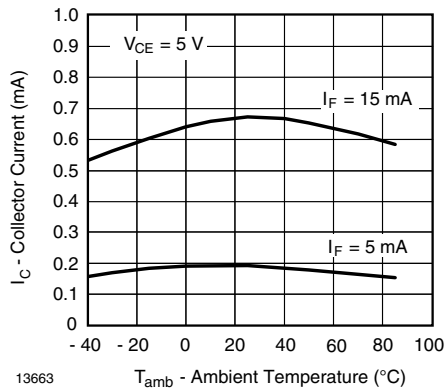


Figure 8. Collector Current vs. Ambient Temperature

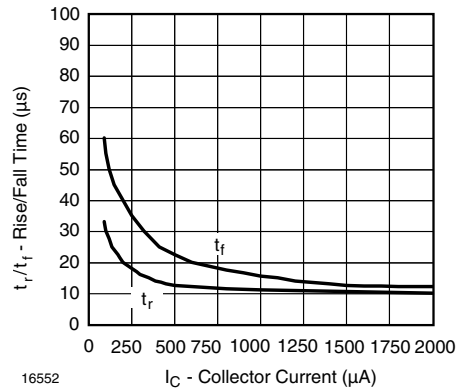


Figure 11. Rise/Fall Time vs. Collector Current

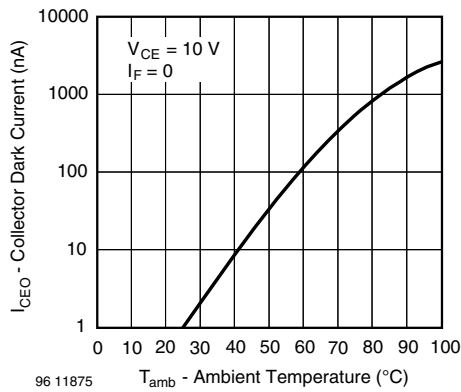


Figure 9. Collector Dark Current vs. Ambient Temperature

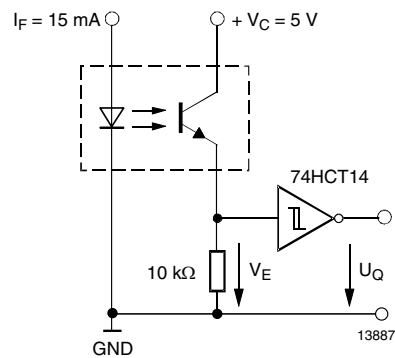


Figure 12. Application example

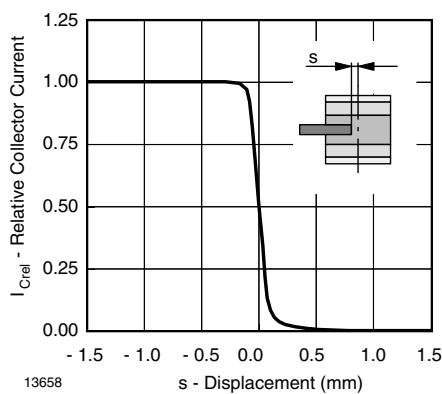


Figure 10. Relative Collector Current vs. Displacement

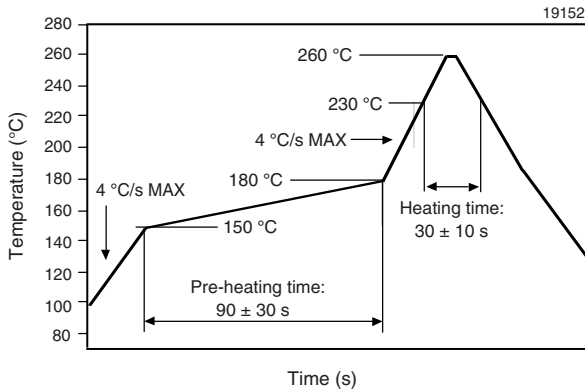
Reflow Solder Profiles


Figure 13. Lead (Pb)-free (Sn) Reflow Solder Profile

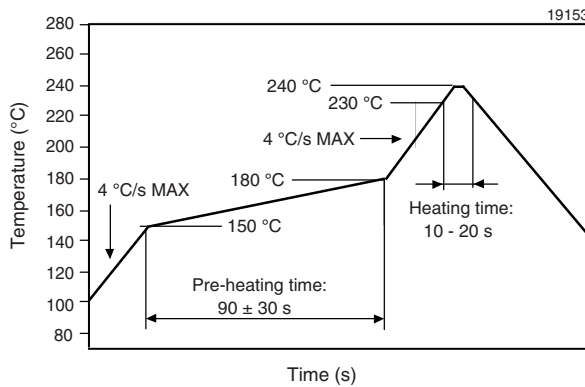


Figure 14. Lead Tin (SnPb) Reflow Solder Profile

Drypack

Devices are packed in moisture barrier bags (MBB) to prevent the products from absorbing moisture during transportation and storage. Each bag contains a desiccant.

Floor Life

Floor life (time between soldering and removing from MBB) must not exceed the time indicated in J-STD-020. According JEDEC, J-STD-020, this component is released to Moisture Sensitivity Level 2, for use of Lead Tin (SnPb) Reflow Solder Profile (Figure 14) or Level 3, for use of Lead (Pb)-free (Sn) Reflow Solder Profile (Figure 13).

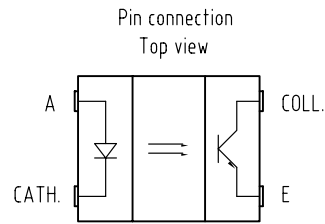
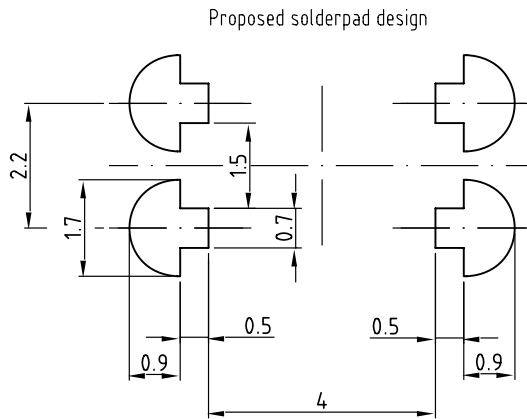
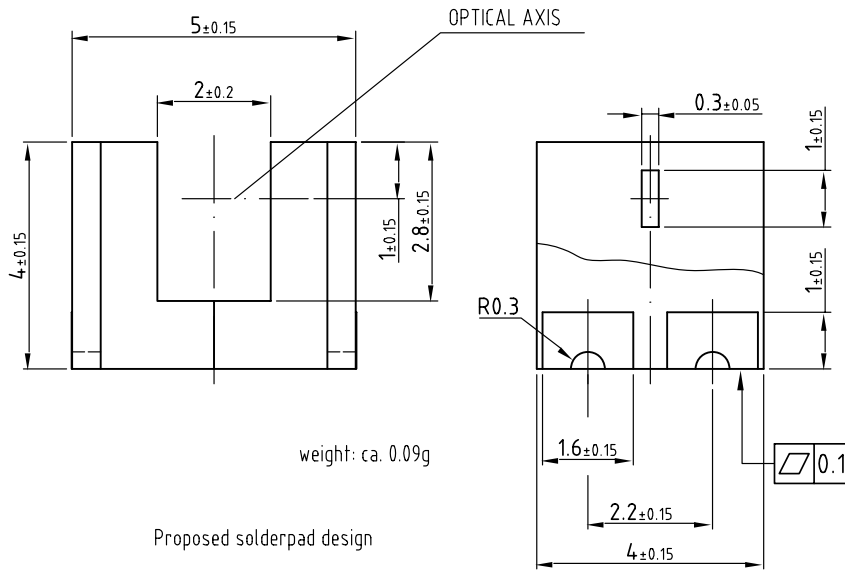
Floor Life: 12 month (Level 2) or 168 hours (Level 3)

Floor Conditions: $T_{amb} < 30\text{ }^{\circ}\text{C}$, RH < 60 %

Drying

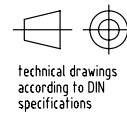
In case of moisture absorption, devices should be baked before soldering. Conditions see J-STD-020 or Label. Devices taped on reel dry using recommended conditions 192 h at 40 °C ($\pm 5\text{ }^{\circ}\text{C}$), RH < 5 % or 96 h at 60 °C ($\pm 5\text{ }^{\circ}\text{C}$), RH < 5 %.

Package Dimensions



All dimensions in mm incl. burrs

Soldering terminal free from contamination and burr



Technical drawings according to DIN specifications

Drawing-No.: 6.541-5043.01-4
Issue: 12; 17.12.04

19310

Ozone Depleting Substances Policy Statement

It is the policy of Vishay Semiconductor GmbH to

1. Meet all present and future national and international statutory requirements.
2. Regularly and continuously improve the performance of our products, processes, distribution and operating systems with respect to their impact on the health and safety of our employees and the public, as well as their impact on the environment.

It is particular concern to control or eliminate releases of those substances into the atmosphere which are known as ozone depleting substances (ODSs).

The Montreal Protocol (1987) and its London Amendments (1990) intend to severely restrict the use of ODSs and forbid their use within the next ten years. Various national and international initiatives are pressing for an earlier ban on these substances.

Vishay Semiconductor GmbH has been able to use its policy of continuous improvements to eliminate the use of ODSs listed in the following documents.

1. Annex A, B and list of transitional substances of the Montreal Protocol and the London Amendments respectively
2. Class I and II ozone depleting substances in the Clean Air Act Amendments of 1990 by the Environmental Protection Agency (EPA) in the USA
3. Council Decision 88/540/EEC and 91/690/EEC Annex A, B and C (transitional substances) respectively.

Vishay Semiconductor GmbH can certify that our semiconductors are not manufactured with ozone depleting substances and do not contain such substances.

We reserve the right to make changes to improve technical design
and may do so without further notice.

Parameters can vary in different applications. All operating parameters must be validated for each customer application by the customer. Should the buyer use Vishay Semiconductors products for any unintended or unauthorized application, the buyer shall indemnify Vishay Semiconductors against all claims, costs, damages, and expenses, arising out of, directly or indirectly, any claim of personal damage, injury or death associated with such unintended or unauthorized use.

Vishay Semiconductor GmbH, P.O.B. 3535, D-74025 Heilbronn, Germany



Disclaimer

All product specifications and data are subject to change without notice.

Vishay Intertechnology, Inc., its affiliates, agents, and employees, and all persons acting on its or their behalf (collectively, "Vishay"), disclaim any and all liability for any errors, inaccuracies or incompleteness contained herein or in any other disclosure relating to any product.

Vishay disclaims any and all liability arising out of the use or application of any product described herein or of any information provided herein to the maximum extent permitted by law. The product specifications do not expand or otherwise modify Vishay's terms and conditions of purchase, including but not limited to the warranty expressed therein, which apply to these products.

No license, express or implied, by estoppel or otherwise, to any intellectual property rights is granted by this document or by any conduct of Vishay.

The products shown herein are not designed for use in medical, life-saving, or life-sustaining applications unless otherwise expressly indicated. Customers using or selling Vishay products not expressly indicated for use in such applications do so entirely at their own risk and agree to fully indemnify Vishay for any damages arising or resulting from such use or sale. Please contact authorized Vishay personnel to obtain written terms and conditions regarding products designed for such applications.

Product names and markings noted herein may be trademarks of their respective owners.