



Reference Board User's Manual for SiC403 (6 A), SiC402 (10 A), and SiC401 (15 A) Synchronous Buck Regulators

PRODUCT SUMMARY SiC401A, SiC401BCD	
Input Voltage Range	3 V to 17 V
Output Voltage Range	0.6 V to $V_{IN} \times 0.75$
Operating Frequency	200 kHz to 1 MHz
Continuous Output Current	15 A
Package	MLP55-32L

PRODUCT SUMMARY SiC402A, SiC402BCD	
Input Voltage Range	3 V to 28 V
Output Voltage Range	0.6 V to $V_{IN} \times 0.75$
Operating Frequency	200 kHz to 1 MHz
Continuous Output Current	10 A
Package	MLP55-32L

PRODUCT SUMMARY SiC403A, SiC403BCD	
Input Voltage Range	3 V to 28 V
Output Voltage Range	0.6 V to $V_{IN} \times 0.75$
Operating Frequency	200 kHz to 1 MHz
Continuous Output Current	6 A
Package	MLP55-32L

Note

- External divider network needed

DESCRIPTION

The SiC401, SiC402, and SiC403 are high frequency voltage-mode constant-on-time (CM-COT) synchronous buck regulators with integrated high-side and low-side power MOSFETs. The SiC403 is capable of 6 A continuous current, the SiC402 is capable of 10 A and the SiC401 15 A. These regulators produce an adjustable output voltage which in standard setup can output 5 V down to 0.6 V and with the V_{OUT} divider network 75 % of V_{IN} down to 0.6 V to accommodate a variety of applications, including computing, consumer electronics, telecom, and industrial.

The CM-COT architecture delivers ultra-fast transient response with minimum output capacitance and tight ripple regulation at very light load. The parts are stable with any capacitor type and no ESR network is required for loop stability. The regulator integrates a full protection feature set, it also has UVLO for the input rail and an internal soft-start.

The SiC40X family is available in lead (Pb)-free power enhanced 5 mm x 5 mm MLP55-32L package.

FEATURES

- SiC401A/B: 3 V to 17 V input range. SiC402A/B, SiC403A/B: 3 V to 28 V input range.
- Adjustable output voltage down to 0.6 V
- 6 A (SiC403), 10 A (SiC402), and 15 A (SiC401) continuous output current
- Selectable frequency from 200 kHz to 1 MHz with an external resistor
- 95 % peak efficiency
- Stable with any capacitor; no external ESR network required
- Ultrafast transient response
- Power saving scheme for increased light load efficiency
- ± 1 % accuracy of V_{OUT} setting
- Cycle-by-cycle current limit
- Fully protected with OTP, SCP, UVP, OVP
- P_{GOOD} Indicator
- 40 °C to +125 °C operating junction temperature
- Output voltage tracking

APPLICATIONS

- Point of load regulation for low-power processors, network processors, DSPs, FPGAs, and ASICs
- Low voltage, distributed power architectures with 5 V or 12 V, or 24 V rails
- Computing, broadband, networking, LAN / WAN, optical, test, and measurement
- A / V, high density cards, storage, DSL, STB, DVR, DTV, industrial PC

ORDERING INFORMATION

BOARD PART NUMBER	MAX. OUTPUT CURRENT
SiC403DB-LC	6 A
SiC402DB-HC	10 A
SiC401DB-HC	15 A

Notes

- LC - low current inductor, HC - high current inductor
- The only difference between HC and LC board is the O / P inductor size



SPECIFICATIONS

This reference board allows the end user to evaluate the SiC401, SiC402, or the SiC403 chip for its features and all functionalities.

It can also be a reference design for a user's application.

CONNECTION AND SIGNAL / TEST POINTS

Power Sockets

V_{IN}, GND (P1): Input voltage source with V_{IN} to be positive. Connect to a voltage source:

- SiC401A/BCD - 3 V to 17 V
- SiC402A/BCD - 3 V to 28 V
- SiC403A/BCD - 3 V to 28 V

V_{OUT}, GND (P3): Output voltage with V_{OUT} to be positive. Connect to a load that draws no more than:

- SiC401A/BCD - 15 A
- SiC402A/BCD - 10 A
- SiC403A/BCD - 6 A

5 V, GND (P5): External 5 V voltage source with 5 V to be positive. Connect to a 5 V source when this option is selected.

SELECTION JUMPERS

Mode Select

P7: This is a 2 way header which allows the user to select either power save mode or constant P_{WM} mode.

OPEN - forced P_{WM}, the pin is floating

SHORT - power save mode, the pin is at 5 V

A third option is available whereby pin 2 is shorted to 0 V to disable the part.

UVLO Option

P8: This is a 2 way header that will enable the UVLO function when selected. The divider resistors R1 and R2 can be changed depending on the required turn on voltage level, the pin requires a voltage greater than 3 V to enable.

OPEN - UVLO disabled

SHORT - UVLO enabled

V_{DD} Select

P6: This is a 3 way header that will enable the user to select between internal LDO and an external 5 V supply.

Position 1 - SHORT PIN 1-2 - internal LDO

Position 2 - SHORT PIN 2-3 - external 5 V

SIGNALS AND TEST LEADS

Input Voltage Sense

V_{IN}_SENSE, GND_{IN}_SENSE (P2): This allows the user to measure the voltage at the input of the regulator and remove any losses generated due to the, connections from the measurement. This can also be used by a power source with sense capability.

Output Voltage Sense

V_{OUT}_SENSE, GND_{OUT}_SENSE (P4): This allows the user to measure the voltage at the output of the regulator and remove any losses generated due to the connections, from the measurement. This can also be used by an active load with sense capability.

PGD (P9): Is an open drain output and is pulled up with a 10 kΩ resistor to V_{IN}. When FB or V_{OUT} are within -10 % to +20 % percent of the set voltage this pin will go HI to indicate the output is okay. The pin will also follow EN/PSV condition switching LO if the IC is disabled.

POWER UP PROCEDURE

To turn-on the reference board, apply 12 V to V_{IN} with the P6 jumper is in Position 1. If the P7 jumper is in place the board will come up in power save mode, if not in place then constant P_{WM} will be observed.

When applying higher than 12 V to the input it is reasonable to install a RC snubber from LX to GND. There are place holders on the reference board R9 and C11 for the snubber. Values of 10 Ω and 1 nF are a reasonable starting point.

ADJUSTMENTS TO THE REFERENCE BOARD

OUTPUT VOLTAGE ADJUSTMENT

If a different output voltage is needed, simply change the value of V_{OUT} and solve for R12 based on the following formula:

$$R_{12} = R_{13} \times \frac{V_{OUT} - V_{FB}}{V_{FB}}$$

Where V_{FB} is 0.6 V for the SiC40X.

CHANGING SWITCHING FREQUENCY

The following equation illustrates the relationship between ON-time, V_{IN}, V_{OUT}, and R_{ON} value:

$$R_{TON} = \frac{k}{25 \text{ pF} \times F_{SW}}$$

Where k equals 1 when V_{DD} is greater than 3.6 V. When k is less than 3.6 V and V_{IN} is greater than ((V_{DD} - 1.75 V) x 10), k is shown by the following equation:

$$k = \frac{(V_{DD} - 1.75 \text{ V}) \times 10}{V_{IN}}$$

The maximum R_{ton} value allowed is shown:

$$R_{TON \text{ MAX.}} = \frac{V_{IN \text{ min.}}}{15 \text{ } \mu\text{A}}$$



OUTPUT RIPPLE VOLTAGE

Output ripple voltage is measured with a tip and barrel measurement across C_{OUT}. Typically output ripple voltage is set to 3 % to 5 % of the output voltage, but an all ceramic output solution can bring output ripple voltage to a much lower level since the ESR of ceramics is very small.

If ceramics or a combination of ceramics and bulk capacitors are used it may be necessary to add a voltage injection network.

VOLTAGE INJECTION NETWORK

This is the network seen placed across the output inductor in the schematic consisting of R8, C9, and C10. A quick method to add or remove injection is to reduce or increase R4.

The time constant of the inductor (τ_{IND}) and voltage injection network are as follows:

$$\tau_{IND} = \frac{L}{DCR}$$

and

$$\tau_{RIN} = R_L \times C_L$$

In (1) the recommended value of C9 = 10 nF.

The injection voltage can be checked for magnitude next using the following equation,

$$V_{INJ} = (V_{IN\ MIN.} - V_{OUT}) \times \left(1 - \frac{1}{e^{\frac{t}{\tau_{RIN}}}} \right)$$

Where t is the ON period. This required magnitude is > 20 mV_{pp} for stable operation, when the ripple injection voltage is smaller than 20 mV_{pp} then double pulsing may be observed as the thresholds are not correctly triggered within the SiC40X.

The injection voltage will be DC decoupled from the FB pin via a capacitor, the calculation for this part is as follows:

$$C_{10} = \frac{1}{\frac{R_{12}}{R_{13}}} \times \frac{3}{2 \times \pi \times F_{SW}}$$

INDUCTOR SELECTION

The choice of inductor is specific to each application and quickly determined with the following equations:

$$t_{ON} = \frac{V_{OUT}}{V_{IN\ MAX.} \times f_{SW}}$$

$$L = \frac{(V_{IN} - V_{OUT}) \times t_{ON}}{I_{OUT\ MAX.} \times k_2}$$

Where k₂ is a percentage of maximum output current ripple required. The designer can quickly make a choice if the ripple percentage is decided, usually no more than 30 % however higher or lower percentages of I_{OUT} can be acceptable depending on application.

Other than the inductance the DCR and saturation current parameters are key values. The DCR causes an I²R loss which will decrease the system efficiency and generate heat. The saturation current has to be higher than the maximum output current plus 1/2 the ripple current. In over current condition the inductor current may be very high. All this needs to be considered when selecting the inductor.

On this board Vishay IHLP series inductors are used to meet cost requirement and high efficiency, a part that utilizes a material that has incredible saturation levels compared to competing products.

OUTPUT CAPACITOR SELECTION

Voltage rating, ESR, transient response, overall PCB area and cost are requirements for selecting output capacitors. The types of capacitors and there general advantages and disadvantages are covered next.

Electrolytic have high ESR, dry out over time so ripple current rating must be examined and have slower transient response, but are fairly inexpensive for the amount of overall capacitance.

Tantalums can come in low ESR varieties and high capacitance value for its overall size, but they fail short when damaged and also have slower transient response.

Ceramics have very low ESR, fast transient response and overall small size, but come in low capacitance values compared to the others above. A combination of technology is sensible.

LDO SETTING

In order that the LDO is programmed to 5 V the divider resistors from the V_{DD} pin to the FBL pin need to be set in order that 0.75 V is present on FBL. They can be set as follows:

$$V_{LDO} = \frac{V_{DD} \times R_8}{R_2 + R_8}$$

ENABLE PIN VOLTAGE

The ENL pin will need to be set to enable the LDO. This pin accepts an input voltage up to V_{IN} however it can also be set as an under voltage trigger. The operation for this pin can be seen in Table 1.

TABLE 1			
EN/PSV	ENL	LDO	SWITCHER
Disabled	Low, < 0.4 V	Off	Off
Enabled	Low, < 0.4 V	Off	On
Disabled	1 V < High < 2.6 V	On	Off
Enabled	1 V < High < 2.6 V	On	Off
Disabled	High > 2.6 V	On	Off
Enabled	High > 2.6 V	On	On

The UVLO will be activated if the voltage present at this pin is below 2.6 V. This can be set using the following equation. If under voltage is not a consideration then this can be connected to V_{IN} . The divider values for this pin can be set using the following equation:

$$V_{ENL} = \frac{V_{IN} \times R_9}{R_1 + R_9}$$

SOFT START SETTING

Soft start is a useful function helping to limit the current draw from the source at switch on. This is simply set with a ceramic capacitor using the following equation:

$$C_{SS} = \frac{t_{SS}}{500\,000}$$

A 2.2 nF capacitor will provide ~ 1 ms soft start time.

BOOTSTRAP CIRCUIT

A bootstrap capacitor of 100 nF will be sufficient for this circuit with switching frequencies from 200 kHz to 500 kHz. A series resistor has been added in order to slow down the low side switch in and minimize overshoot without adding a snubber. This is user adjustable.

V_{DD} DECOUPLING

The V_{DD} pin will need to be decoupled in order to provide a stable voltage internally and externally. The value for this capacitor is recommended as $\geq 1 \mu\text{F}$.

CURRENT LIMIT RESISTOR

The current limit is set by placing a resistor between pins LXS and ILIM. The values can be found using the following equations.

SiC401:

$$R_{ILIM} = 792 \times I_{LIM} \times [0.101 \times (5\text{ V} - V_{DD}) + 1]$$

SiC402:

$$R_{ILIM} = 446 \times I_{LIM} \times [0.099 \times (5\text{ V} - V_{DD}) + 1]$$

SiC403:

$$R_{ILIM} = 1176 \times I_{LIM} \times [0.112 \times (5\text{ V} - V_{DD}) + 1]$$

OUTPUT CAPACITANCE

The output capacitance will be determined by the ripple voltage requirement. Voltage mode COT topology can work with very small values of capacitor ESR however a ripple injection network will also be required for stable operation.

The overall capacitance needs to be calculated next. The following equations are used to calculate the size needed to meet a transient load response:

$$I_{LPK} = I_{MAX.} + 0.5 \times I_{RIPPLE\ MAX.}$$

$$C_{OUT\ MIN.} = I_{LPK} \times \frac{L \times \frac{I_{LPK}}{V_{OUT}} - \frac{I_{MAX.}}{dI_{LOAD}} \times dt}{2 \times (V_{PK} - V_{OUT})}$$

Where I_{LPK} is the peak inductor current, $I_{MAX.}$ is the maximum output current, dI_{LOAD} is the current step in μF and V_{PK} is the peak voltage, the output voltage summed with the specified over and under shoot.

INPUT CAPACITANCE

In order to keep the design compact and minimize parasitic elements, ceramic capacitors will be chosen. The initial requirement for the input capacitance is decided by the maximum input voltage, 16 V in this case however a 35 V rated capacitor will be chosen of the X7R variety. The footprint will be a compact 1206.

In order to determine the minimum capacitance the input voltage ripple needs to be specified; $V_{CINPP} \leq 150\text{ mV}$ is a suitable starting point. This magnitude is determined by the final application specification. The input current needs to be determined for the lowest operating input voltage:

$$I_{CIN(RMS)} = \frac{I_{OUT}}{V_{IN}} \times \sqrt{V_{OUT} \times (V_{IN} - V_{OUT})}$$

The minimum input capacitance can then be found,

$$C_{IN\ MIN.} = I_{OUT} \times \frac{DC - (1 - DC)}{V_{CINPP} \times F_{SW}}$$

HIGH OUTPUT VOLTAGE OPERATION

For the SiC40X family the recommended maximum output voltage of no more than 75 % of V_{IN} .

For applications where an output voltage greater than 5 V is required a resistive network should be used to step down the output voltage in order to provide the $V_{OUT\ PIN}$ with 4.5 V.

$$R_1 = \frac{R_2 \times (V_{OUT} - V_{OUT\ PIN})}{V_{OUT\ PIN}}$$

For example, if an output voltage of $V_{OUT} = 8.5\text{ V}$ is required, setting $R_2 = 10\text{ k}\Omega$ and $V_{OUT\ PIN} = 4.5\text{ V}$ results in $R_1 = 8870\ \Omega$.

The switching frequency will also need recalculating using a $V_{OUT\ PIN}$ magnitude of 4.5 V.

$$F_{SW} = \frac{V_{OUT\ PIN}}{t_{ON} \times V_{IN}}$$

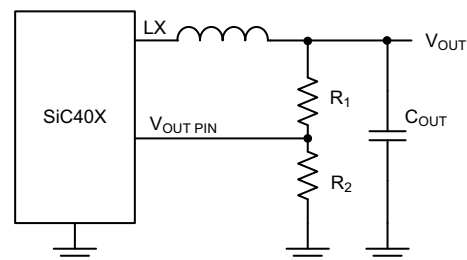

Fig. 1 - Resistor Divider Network Allows 4.5 V at the $V_{OUT\ PIN}$

LAYOUT CONSIDERATIONS

The SiC40x family of footprint compatible 15 A, 10 A, and 6 A products offers the designer a scalable buck regulator solution. If the below layout recommendations are followed, the same layout can be used to cover a wide range of output currents and voltages without any changes to the board design and only minor changes to the component values in the schematic.

The reference design has a majority of the components placed on the top layer. This allows for easy assembly and straightforward layout.

Figure 2 outlines the pointers for the layout considerations and the explanations follow.

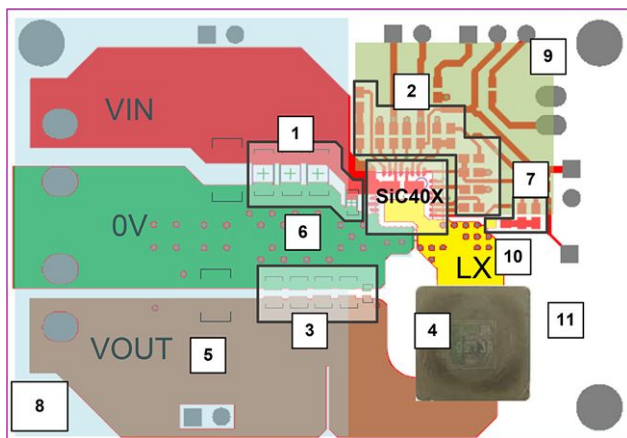

Fig. 2 - Resistor Divider Network Allows 4.5 V at the V_{OUT} PIN

1. Place input ceramic capacitors close to the voltage input pins with a small 10 nF / 100 nF placed as close as the design rules will allow. This will help reduce the size of the input high frequency current loop and consequently reduce the high frequency ripple noise seen at the input and the LX node.
2. Place the setup and control passive devices logically around the IC with the intention of placing a quiet ground plane beneath them on a secondary layer.
3. It is advisable to use ceramic capacitors at the output to reduce impedance. Place these as close to the IC P_{GND} and output voltage node as design will allow. Place a small 10 nF / 100 nF ceramic capacitor closest to the IC and inductor loop.
4. The loop between LX, V_{OUT} and the IC GND should be as compact as possible. This will lower series resistance and also make the current loop smaller enabling the high frequency response of the output capacitors to take effect.
5. The output impedance should be small when high current is required; use high current traces, multiple layers can be used with many vias.
6. Use many vias when multiple layers are involved. This will have the effect of lowering the resistance between layers and reducing the via inductance of the PCB nets.
7. If a voltage injection network is needed then place it near to the inductor LX node.
8. P_{GND} can be used on internal layers if the resistance of the PCB is to be small; this will also help remove heat. Use extra vias if needed but be mindful to allow a path between the vias.
9. A quiet plane should be employed for the A_{GND}, this is placed under the small signal passives. This can be placed on multiple layers if needed for heat removal. This should be connected to the P_{GND} plane near to the input GND at one connection only of at least 1mm width.
10. The LX copper can also be used on multiple layers, use a number of vias.
11. The copper area beneath the inductor has been removed (on all layers) in this design to reduce the inductive coupling that occurs between the inductor and the GND trace. No other voltage planes should be placed under this area.

PCB LAYOUT

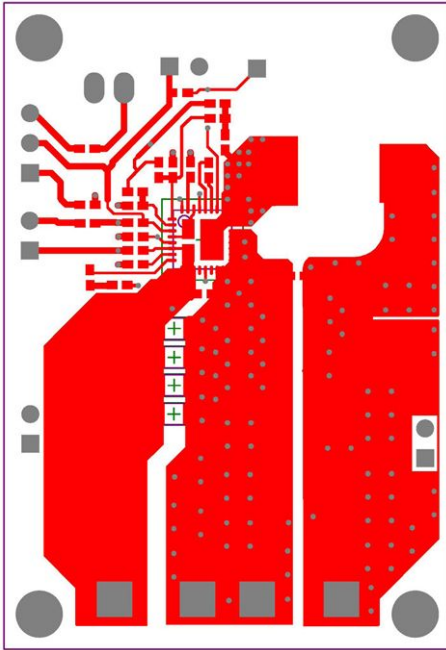

Fig. 3 - Top Layer

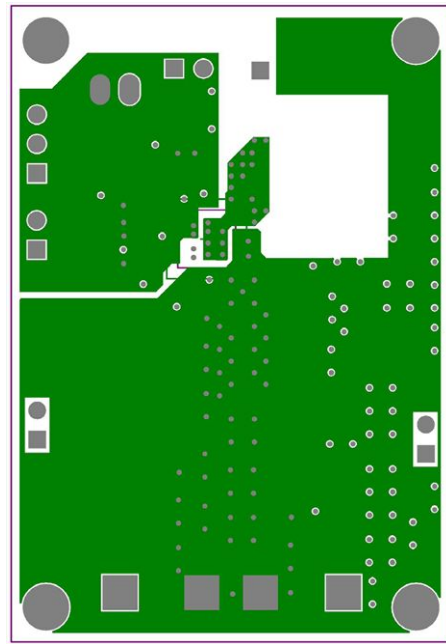

Fig. 5 - Inner Layer 2

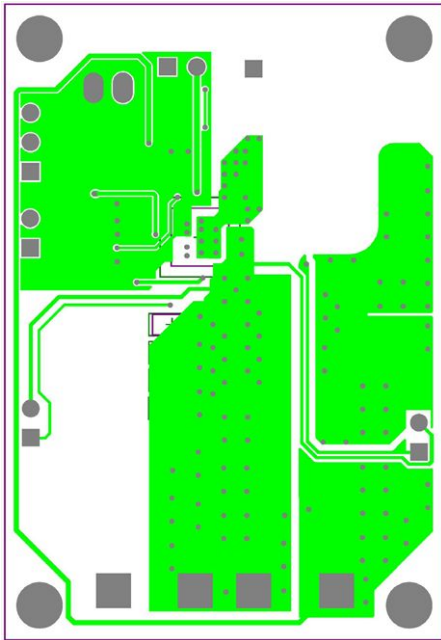

Fig. 4 - Inner Layer 1

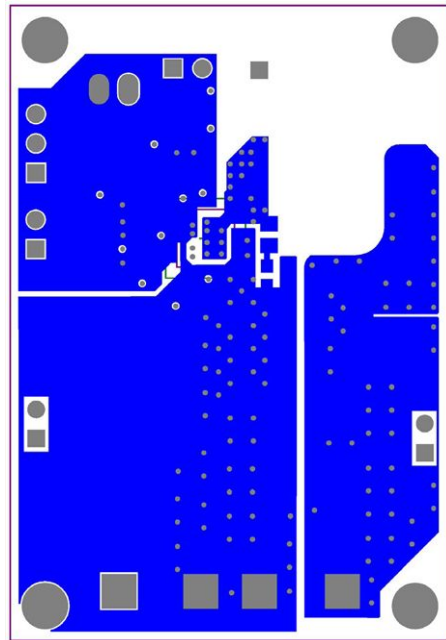
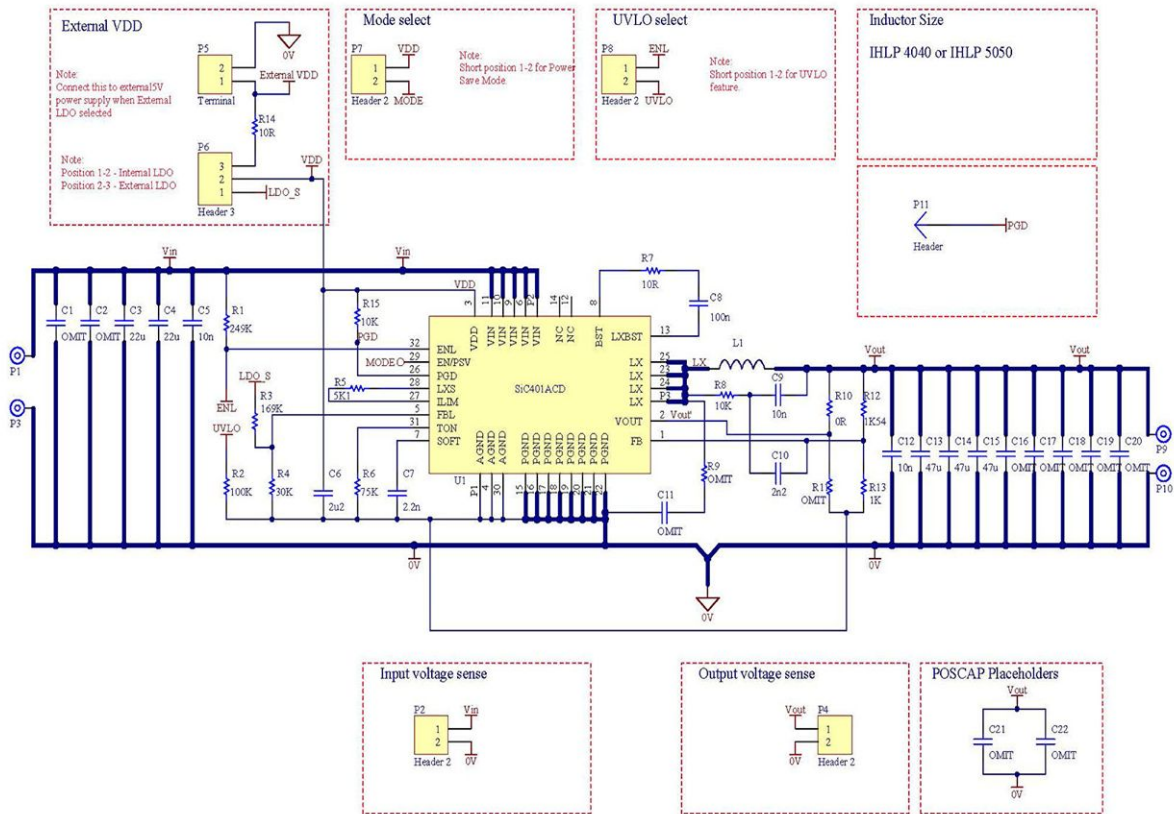

Fig. 6 - Bottom Layer

SCHEMATIC - COMMON TO ALL BOARDS





BILL OF MATERIAL FOR SIC401 ($V_{IN} = 12\text{ V}$, $V_{OUT} = 1.5\text{ V}$, $F_{SW} = 500\text{ kHz}$)							
ITEM	QTY	REFERENCE	PCB FOOTPRINT	VALUE	VOLTAGE	PART NUMBER	MANUFACTURER
1	2	C1, C2	1206	Omit	35 V	C3216X5R1V226M160AC	TDK
2	2	C3, C4	1206	22 μF	35 V	C3216X5R1V226M160AC	TDK
3	3	C5, C9, C12	0402	10 nF	50 V	GRM155R71H103KA88D	Murata
4	1	C6	0402	2.2 μF	10 V	C0402C225M8PACTU	Kemet
5	2	C7, C10	0402	2.2 nF	50 V	GRM155R71H222KA01D	Murata
6	1	C8	0402	100 nF	35 V	CGA2B3X7R1V104K050BB	Vishay
7	5	C13, C14, C15, C16, C17	1206	47 μF	35 V	GRM31CR61A476ME15L	Murata
8	3	C18, C19, C20	1206	Omit	35 V	GRM31CR61A476ME15L	Murata
9	2	C21, C22	7343	Omit	-	-	-
10	4	P1, P3, P9, P10	Banana Jack	-	-	575-4K-ND	Keystone
11	5	P2, P4, P5, P7, P8	Header-2	-	-	826926-2	AMP (TE)
12	1	P6	Header-3	-	-	HTSW-103-08-T-S	Samtec
13	1	L1	IHLP5050	1 μH	-	IHLP5050FDER1R0	Vishay
14	1	R1	0402	249K	-	CRCW0402249KFKED	Vishay
15	1	R2	0402	100K	-	CRCW0402100KFKED	Vishay
16	1	R3	0402	169K	-	CRCW0402169KFKED	Vishay
17	1	R4	0402	30K	-	CRCW040230K0FKED	Vishay
18	1	R5	0402	5K11	-	CRCW04025K11FKED	Vishay
19	1	R6	0402	76K8	-	CRCW040276K8FKED	Vishay
20	1	R7	0402	10R	-	CRCW040210R0FKEA	Vishay
21	1	R8	0402	10K	-	CRCW040210K0FKED	Vishay
22	1	R9	0805	Omit	-	-	Vishay
23	1	R10	0402	0R	-	CRCW04020000Z0ED	Vishay
24	1	R11	0402	Omit	-	-	Vishay
25	1	R12	0402	1K54	-	CRCW04021K54FKED	Vishay
26	1	R13	0402	1K	-	CRCW0402249KFKED	Vishay
27	1	R14	0402	10R	-	CRCW040210R0FKEA	Vishay
28	1	R15	0402	10K	-	CRCW040210K0FKED	Vishay
29	1	U1	MLP55-33	SIC401	-	-	-

KEY Only needed for reference board



BILL OF MATERIAL FOR SIC402 ($V_{IN} = 12\text{ V}$, $V_{OUT} = 1.5\text{ V}$, $F_{SW} = 500\text{ kHz}$)							
ITEM	QTY	REFERENCE	PCB FOOTPRINT	VALUE	VOLTAGE	PART NUMBER	MANUFACTURER
1	2	C1, C2	1206	Omit	35 V	C3216X5R1V226M160AC	TDK
2	2	C3, C4	1206	22 μF	35 V	C3216X5R1V226M160AC	TDK
3	3	C5, C9, C12	0402	10 nF	50 V	GRM155R71H103KA88D	Murata
4	1	C6	0402	2.2 μF	10 V	C0402C225M8PACTU	Kemet
5	2	C7, C10	0402	2.2 nF	50 V	GRM155R71H222KA01D	Murata
6	1	C8	0402	100 nF	35 V	CGA2B3X7R1V104K050BB	Vishay
7	3	C13, C14, C15	1206	47 μF	35 V	GRM31CR61A476ME15L	Murata
8	5	C16, C17, C18, C19, C20	1206	Omit	35 V	GRM31CR61A476ME15L	Murata
9	2	C21, C22	7343	Omit	-	-	-
10	4	P1, P3, P9, P10	Banana Jack	-	-	575-4K-ND	Keystone
11	5	P2, P4, P5, P7, P8	Header-2	-	-	826926-2	AMP (TE)
12	1	P6	Header-3	-	-	HTSW-103-08-T-S	Samtec
13	1	L1	IHLP4040	1 μH	-	IHLP4040DZER1R0	Vishay
14	1	R1	0402	249K	-	CRCW0402249KFKED	Vishay
15	1	R2	0402	100K	-	CRCW0402100KFKED	Vishay
16	1	R3	0402	169K	-	CRCW0402169KFKED	Vishay
17	1	R4	0402	30K	-	CRCW040230K0FKED	Vishay
18	1	R5	0402	5K11	-	CRCW04025K11FKED	Vishay
19	1	R6	0402	76K8	-	CRCW040276K8FKED	Vishay
20	1	R7	0402	10R	-	CRCW040210R0FKEA	Vishay
21	1	R8	0402	10K	-	CRCW040210K0FKED	Vishay
22	1	R9	0805	Omit	-	-	Vishay
23	1	R10	0402	0R	-	CRCW04020000Z0ED	Vishay
24	1	R11	0402	Omit	-	-	Vishay
25	1	R12	0402	1K54	-	CRCW04021K54FKED	Vishay
26	1	R13	0402	1K	-	CRCW0402249KFKED	Vishay
27	1	R14	0402	10R	-	CRCW040210R0FKEA	Vishay
28	1	R15	0402	10K	-	CRCW040210K0FKED	Vishay
29	1	U1	MLP55-33	SIC402	-	-	-

KEY Only needed for reference board



BILL OF MATERIAL FOR SIC403 LC ($V_{IN} = 12\text{ V}$, $V_{OUT} = 1.5\text{ V}$, $F_{SW} = 500\text{ kHz}$)							
ITEM	QTY	REFERENCE	PCB FOOTPRINT	VALUE	VOLTAGE	PART NUMBER	MANUFACTURER
1	3	C1, C2, C3	1206	Omit	35 V	C3216X5R1V226M160AC	TDK
2	1	C4	1206	22 μF	35 V	C3216X5R1V226M160AC	TDK
3	3	C5, C9, C12	0402	10 nF	50 V	GRM155R71H103KA88D	Murata
4	1	C6	0402	2.2 μF	10 V	C0402C225M8PACTU	Kemet
5	2	C7, C10	0402	1 nF	50 V	GRM155R71H102KA01D	Murata
6	1	C8	0402	100 nF	35 V	CGA2B3X7R1V104K050BB	Vishay
7	2	C13, C14	1206	47 μF	35 V	GRM31CR61A476ME15L	Murata
8	6	C15, C16, C17 C18, C19, C20	1206	Omit	35 V	GRM31CR61A476ME15L	Murate
9	2	C21, C22	7343	Omit	-	-	-
10	4	P1, P3, P9, P10	Banana Jack	-	-	575-4K-ND	Keystone
11	5	P2, P4, P5, P7, P8	Header-2	-	-	826926-2	AMP (TE)
12	1	P6	Header-3	-	-	HTSW-103-08-T-S	Samtec
13	1	L1	IHLP3232	2.2 μH	-	IHLP3232DZER2R2	Vishay
14	1	R1	0402	249K	-	CRCW0402249KFKED	Vishay
15	1	R2	0402	100K	-	CRCW0402100KFKED	Vishay
16	1	R3	0402	169K	-	CRCW0402169KFKED	Vishay
17	1	R4	0402	30K	-	CRCW040230K0FKED	Vishay
18	1	R5	0402	5K11	-	CRCW04025K11FKED	Vishay
19	1	R6	0402	76K8	-	CRCW040276K8FKED	Vishay
20	1	R7	0402	10R	-	CRCW040210R0FKEA	Vishay
21	1	R8	0402	10K	-	CRCW040210K0FKED	Vishay
22	1	R9	0805	Omit	-	-	Vishay
23	1	R10	0402	0R	-	CRCW04020000Z0ED	Vishay
24	1	R11	0402	Omit	-	-	Vishay
25	1	R12	0402	1K54	-	CRCW04021K54FKED	Vishay
26	1	R13	0402	1K	-	CRCW0402249KFKED	Vishay
27	1	R14	0402	10R	-	CRCW040210R0FKEA	Vishay
28	1	R15	0402	10K	-	CRCW040210K0FKED	Vishay
29	1	U1	MLP55-33	SIC403	-	-	-

KEY Only needed for reference board

Vishay Siliconix maintains worldwide manufacturing capability. Products may be manufactured at one of several qualified locations. Reliability data for Silicon Technology and Package Reliability represent a composite of all qualified locations. For related documents such as package/tape drawings, part marking, and reliability data, see www.vishay.com/ppg?62923.