

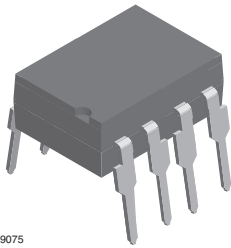

## High Speed Optocoupler, Dual, 5 MBd

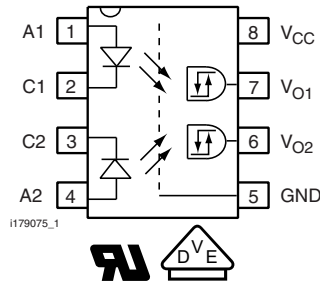

1179075



### FEATURES

- Data rate 5 Mbits/s (2.5 Mbit/s over temperature)
- Buffer
- Isolation test voltage, 5300 V<sub>RMS</sub>
- TTL, LSTTL, and CMOS compatible
- Internal shield for very high common mode transient immunity
- Wide supply voltage range (4.5 V to 15 V)
- Low input current (1.6 mA to 5 mA)
- Specified from - 40 °C to 85 °C
- Material categorization: for definitions of compliance please see [www.vishay.com/doc?99912](http://www.vishay.com/doc?99912)

RoHS  
COMPLIANT

### DESCRIPTION

The dual channel 5 Mb/s SFH6731 and SFH6732 high speed optocoupler consists of a GaAlAs infrared emitting diode, optically coupled with an integrated photo detector. The detector incorporates a Schmitt-Trigger stage for improved noise immunity. A Faraday shield provides a common mode transient immunity of 1000 V/μs at V<sub>CM</sub> = 50 V for SFH6731 and 500 V/μs at V<sub>CM</sub> = 300 V for SFH6732.

The SFH6731 and SFH6732 uses an industry standard DIP-8 package. With standard lead bending, creepage distance and clearance of ≥ 7 mm with lead bending options 6, 7 and 9 ≥ 8 mm are achieved.

### AGENCY APPROVALS

- UL1577 (pending)
- DIN EN 60747-5-5 (VDE 0884) (pending)
- cUL
- CQC

### APPLICATIONS

- Industrial control
- Replace pulse transformers
- Routine logic interfacing
- Motion/power control
- High speed line receiver
- Microprocessor system interfaces
- Computer peripheral interfaces

### ORDERING INFORMATION

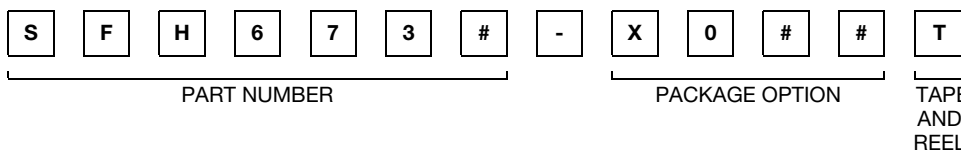

AGENCY CERTIFIED/PACKAGE	CMR (kV/μs)	CMR (kV/μs)
UL	1	5
DIP-8	SFH6731	SFH6732
SMD-8, option 7	-	SFH6732-X007T
VDE, UL	1	5
SMD-8, option 7	SFH6731-X017T	-

### TRUTH TABLE (positive logic)

PARTS	IR DIODE	OUTPUT
SFH6731	On	H
	Off	L
SFH6732	On	H
	Off	L



ABSOLUTE MAXIMUM RATINGS ( $T_{amb} = 25\text{ }^{\circ}\text{C}$ , unless otherwise specified)				
PARAMETER	TEST CONDITION	SYMBOL	VALUE	UNIT
<b>INPUT</b>				
Reverse voltage		$V_R$	3	V
DC Forward current		$I_F$	10	mA
Surge forward current	$t_p \leq 1\text{ }\mu\text{s}$ , 300 pulses/s	$I_{FSM}$	1	A
Power dissipation		$P_{diss}$	20	mW
<b>OUTPUT</b>				
Supply voltage		$V_{CC}$	- 0.5 to + 15	V
Output voltage		$V_O$	- 0.5 to + 15	V
Average output current		$I_O$	25	mA
Power dissipation		$P_{diss}$	100	mW
<b>COUPLER</b>				
Storage temperature range		$T_{stg}$	- 55 to + 150	$^{\circ}\text{C}$
Ambient temperature range		$T_{amb}$	- 40 to + 85	$^{\circ}\text{C}$
Lead soldering temperature	$t = 10\text{ s}$	$T_s$	260	$^{\circ}\text{C}$
Isolation test voltage	$t = 1\text{ min}$	$V_{ISO}$	5300	$V_{RMS}$
Pollution degree			2	
Creepage distance and clearance	Standard lead bending		7	mm
	Option 6, 7, 9		8	mm
Comparative tracking index per DIN IEC 112/VDE 0303, part 1		CTI	175	
Isolation resistance	$V_{IO} = 500\text{ V}$ , $T_{amb} = 25\text{ }^{\circ}\text{C}$	$R_{IO}$	$10^{12}$	$\Omega$
	$V_{IO} = 500\text{ V}$ , $T_{amb} = 100\text{ }^{\circ}\text{C}$	$R_{IO}$	$10^{11}$	$\Omega$

**Note**

- Stresses in excess of the absolute maximum ratings can cause permanent damage to the device. Functional operation of the device is not implied at these or any other conditions in excess of those given in the operational sections of this document. Exposure to absolute maximum ratings for extended periods of the time can adversely affect reliability

ELECTRICAL CHARACTERISTICS ( $T_{amb} = 25\text{ }^{\circ}\text{C}$ , unless otherwise specified)						
PARAMETER	TEST CONDITION	SYMBOL	MIN.	TYP.	MAX.	UNIT
<b>INPUT <sup>(1)</sup></b>						
Forward voltage	$I_F = 5\text{ mA}$	$V_F$		1.6	1.75	V
		$V_F$			1.8	V
Input current hysteresis	$V_{CC} = 5\text{ V}$ , $I_{HYS} = I_{Fon} - I_{Foff}$			01		mA
Reverse current	$V_R = 3\text{ V}$	$I_R$		0.5	10	$\mu\text{A}$
Capacitance	$V_R = 0\text{ V}$ , $f = 1\text{ MHz}$	$C_O$		60		pF
Thermal resistance		$R_{thja}$		700		K/W
<b>OUTPUT <sup>(1)</sup></b>						
Logic low output voltage	$I_{OL} = 6.4\text{ mA}$	$V_{OL}$			0.5	V
Logic high output voltage	$I_{OH} = - 2.6\text{ mA}$ , $V_{OH} = V_{CC} - 1.8\text{ V}$ <sup>(2)</sup>	$V_{OH}$	2.4	<sup>(2)</sup>		V
Output leakage current ( $V_{OUT} > V_{CC}$ )	$V_O = 5.5\text{ V}$ , $V_{CC} = 4.5\text{ V}$ , $I_F = 5\text{ mA}$	$I_{OHH}$		0.5	100	$\mu\text{A}$
	$V_O = 15\text{ V}$ , $V_{CC} = 4.5\text{ V}$ , $I_F = 5\text{ mA}$	$I_{OHH}$		1	500	$\mu\text{A}$
Logic low supply current	$V_{CC} = 5.5\text{ V}$ , $I_F = 0\text{ A}$	$I_{CCL}$		3.7	6	mA
	$V_{CC} = 15\text{ V}$ , $I_F = 0\text{ A}$	$I_{CCL}$		4.1	6.5	mA
Logic high supply current	$V_{CC} = 5.5\text{ V}$ , $I_F = 5\text{ mA}$	$I_{CCH}$		3.4	4	mA
	$V_{CC} = 15\text{ V}$ , $I_F = 5\text{ mA}$	$I_{CCH}$		3.7	5	mA
Logic low short circuit output current	$V_O = V_{CC} = 5.5\text{ V}$ , $I_F = 0\text{ A}$	$I_{OSL}$	25			mA
	$V_O = V_{CC} = 15\text{ V}$ , $I_F = 0\text{ A}$	$I_{OSL}$	40			mA



ELECTRICAL CHARACTERISTICS ( $T_{amb} = 25\text{ }^{\circ}\text{C}$ , unless otherwise specified)						
PARAMETER	TEST CONDITION	SYMBOL	MIN.	TYP.	MAX.	UNIT
<b>OUTPUT</b>						
Logic high short circuit output current	$V_{CC} = 5.5\text{ V}, V_O = 0\text{ V}, I_F = 5\text{ mA}$	$I_{OSH}$			- 10	mA
	$V_{CC} = 15\text{ V}, V_O = 0\text{ V}, I_F = 5\text{ mA}$	$I_{OSH}$			- 25	mA
Thermal resistance				300		K/W
<b>COUPLER</b>						
Capacitance (input to output)	$f = 1\text{ MHz}$ , pins 1 to 4 and 5 to 8 shorted together	$C_{IO}$		0.6		pF

**Notes**

- Minimum and maximum values are testing requirements. Typical values are characteristics of the device and are the result of engineering evaluation. Typical values are for information only and are not part of the testing requirements
- (1)  $0\text{ }^{\circ}\text{C} \leq T_{amb} \leq 85\text{ }^{\circ}\text{C}$ ;  $4.5\text{ V} \leq V_{CC} \leq 15\text{ V}$ ;  $1.6\text{ mA} \leq I_{Fon} \leq 5\text{ mA}$ ;  $2 \leq V_{EH} \leq 15\text{ V}$ ;  $0 \leq V_{EL} \leq 0.8\text{ V}$ ;  $0\text{ mA} \leq I_{Foff} \leq 0.1\text{ mA}$ . Typical values:  $T_{amb} = 25\text{ }^{\circ}\text{C}$ ;  $V_{CC} = 5\text{ V}$ ;  $I_{Fon} = 3\text{ mA}$  unless otherwise specified
- (2) Output short circuit time  $\leq 10\text{ ms}$

SWITCHING CHARACTERISTICS						
PARAMETER	TEST CONDITION	SYMBOL	MIN.	TYP.	MAX.	UNIT
Propagation delay time to logic low output level	without peaking capacitor	$t_{PHL}$		120		ns
	with peaking capacitor	$t_{PHL}$		115	300	ns
	without peaking capacitor	$t_{PLH}$		125		ns
	with peaking capacitor	$t_{PLH}$		90	300	ns
Output rise time	10 % to 90 %	$t_r$		40		ns
Output fall time	90 % to 10 %	$t_f$		10		ns

**Note**

- $0\text{ }^{\circ}\text{C} \leq T_{amb} \leq 85\text{ }^{\circ}\text{C}$ ;  $4.5\text{ V} \leq V_{CC} \leq 15\text{ V}$ ;  $1.6\text{ mA} \leq I_{Fon} \leq 5\text{ mA}$ ;  $0\text{ mA} \leq I_{Foff} \leq 0.1\text{ mA}$ . Typical values:  $T_{amb} = 25\text{ }^{\circ}\text{C}$ ;  $V_{CC} = 5\text{ V}$ ;  $I_{Fon} = 3\text{ mA}$  unless otherwise specified

RECOMMENDED OPERATING CONDITIONS						
PARAMETER	TEST CONDITION	SYMBOL	MIN.	TYP.	MAX.	UNIT
Supply voltage		$V_{CC}$	4.5		15	V
Forward input current		$I_{Fon}$	1.6 <sup>(1)</sup>		5	mA
		$I_{Foff}$			0.1	mA
Operating temperature		$T_A$	0		85	$^{\circ}\text{C}$

**Notes**

- A 0.1  $\mu\text{F}$  bypass capacitor connected between pins 5 and 8 must be used
- (1) We recommend using a 2.2 mA to permit at least 20 % CTR degradation guard band

COMMON MODE TRANSIENT IMMUNITY							
PARAMETER	TEST CONDITION	PART	SYMBOL	MIN.	TYP.	MAX.	UNIT
Logic high common mode transient immunity <sup>(1)</sup>	$ V_{CM}  = 50\text{ V}, I_F = 1.6\text{ mA}$	SFH6731	$ CM_H $	1000			V/ $\mu\text{s}$
	$ V_{CM}  = 300\text{ V}, I_F = 1.6\text{ mA}$	SFH6732	$ CM_H $	5000			V/ $\mu\text{s}$
Logic low common mode transient immunity <sup>(1)</sup>	$ V_{CM}  = 50\text{ V}, I_F = 0\text{ mA}$	SFH6731	$ CM_L $	1000			V/ $\mu\text{s}$
	$ V_{CM}  = 1000\text{ V}, I_F = 0\text{ mA}$	SFH6732	$ CM_L $	10 000			V/ $\mu\text{s}$

**Notes**

- $T_{amb} = 25\text{ }^{\circ}\text{C}$ ,  $V_{CC} = 5\text{ V}$ <sup>(1)</sup>
- (1) CMH is the maximum slew rate of a common mode voltage VCM at which the output voltage remains at logic high level ( $V_O > 2\text{ V}$ ). CML is the maximum slew rate of a common mode voltage VCM at which the output voltage remains at logic low level ( $V_O < 0.8\text{ V}$ )



SAFETY AND INSULATION RATINGS						
PARAMETER	TEST CONDITION	SYMBOL	MIN.	TYP.	MAX.	UNIT
Climatic classification	According to IEC 68 part 1			40/85/21		
Comparative tracking index		CTI	175		399	
$V_{IOTM}$			8000			V
$V_{IORM}$			890			V
$P_{SO}$					500	mW
$I_{SI}$					300	mA
$T_{SI}$					175	°C
Creepage distance	Standard DIP-8		8			mm
Clearance distance	Standard DIP-8		7			mm
Creepage distance	400 mil DIP-8		8			mm
Clearance distance	400 mil DIP-8		8			mm

**Note**

- As per DIN EN 60747-5-2 (VDE 0884), § 7.4.3.8.1, this optocoupler is suitable for "safe electrical insulation" only within the safety ratings. Compliance with the safety ratings shall be ensured by means of protective circuits

**TYPICAL CHARACTERISTICS** ( $T_{amb} = 25\text{ °C}$ , unless otherwise specified)

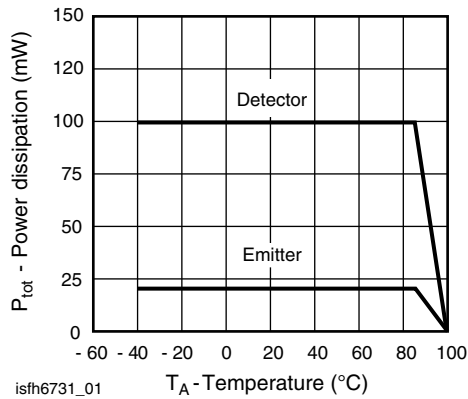

Fig. 1 - Permissible Total Power Dissipation vs. Temperature

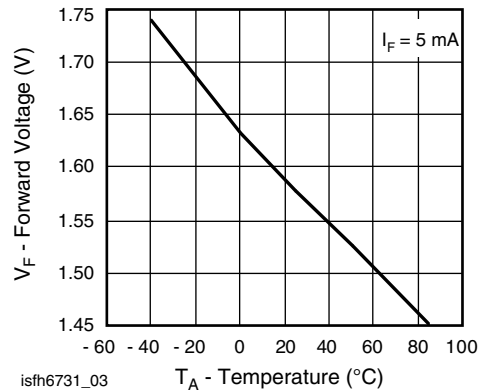

Fig. 3 - Typical Forward Input Voltage vs. Temperature

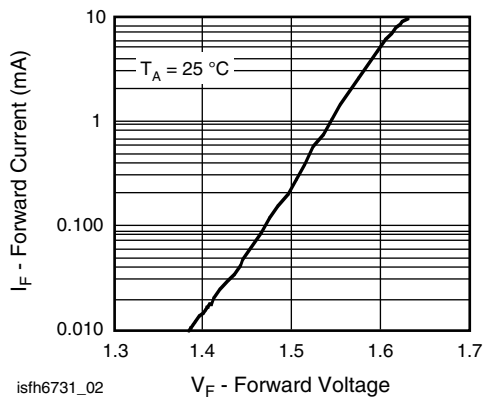

Fig. 2 - Typical Input Diode Forward Current vs. Forward Voltage

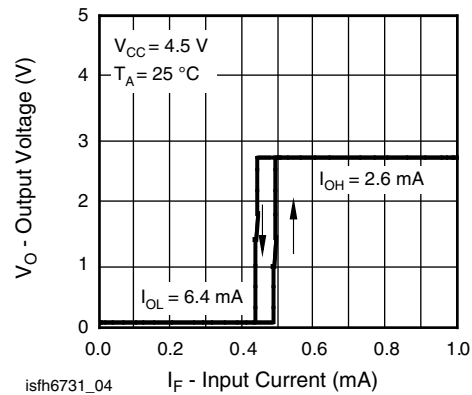

Fig. 4 - Typical Output Voltage vs. Forward Input Current

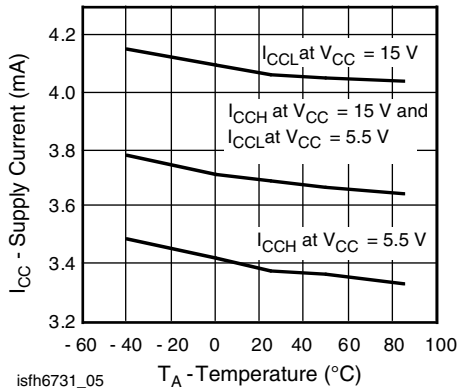

Fig. 5 - Typical Supply Current vs. Temperature

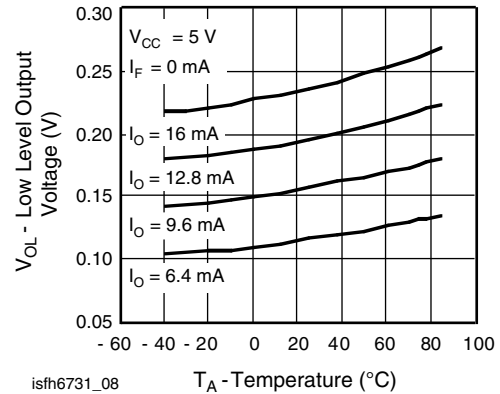

Fig. 8 - Typical Low Level Output Voltage vs. Temperature

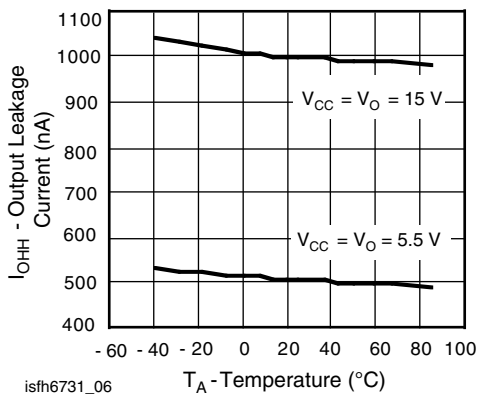

Fig. 6 - Typical Output Leakage Current vs. Temperature

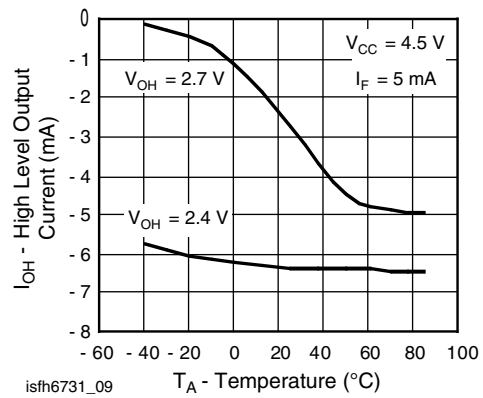

Fig. 9 - Typical High Level Output Current vs. Temperature

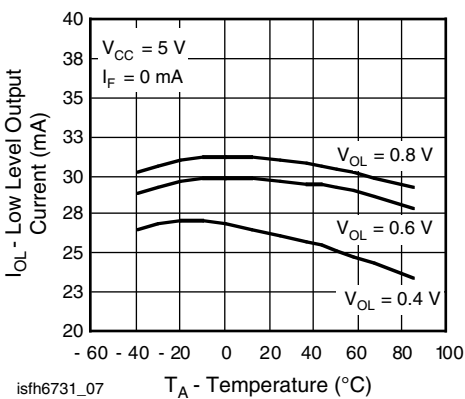

Fig. 7 - Typical Low Level Output Current vs. Temperature

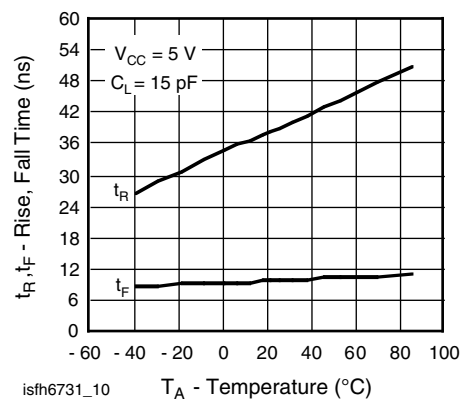

Fig. 10 - Rise and Fall Time vs. Ambient Temperature

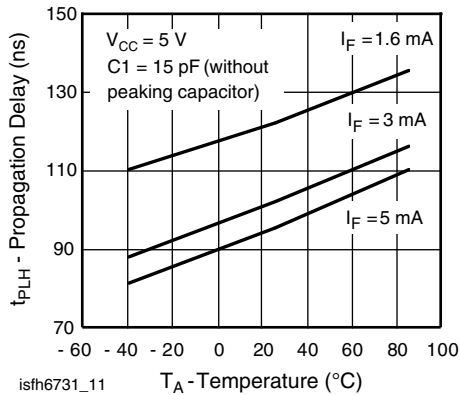

Fig. 11 - Typical Propagation Delays to Logic High vs. Temperature

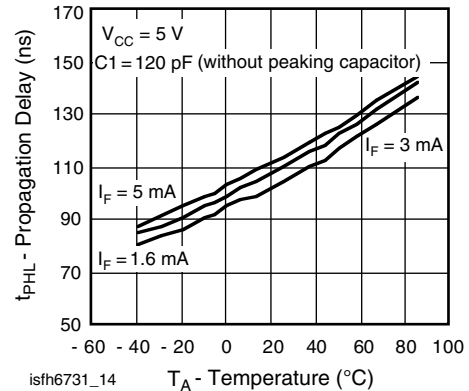

Fig. 14 - Typical Propagation Delays to Logic Low vs. Temperature

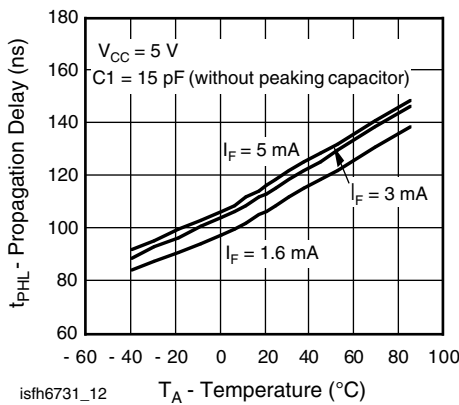

Fig. 12 - Typical Propagation Delays to Logic Low vs. Temperature

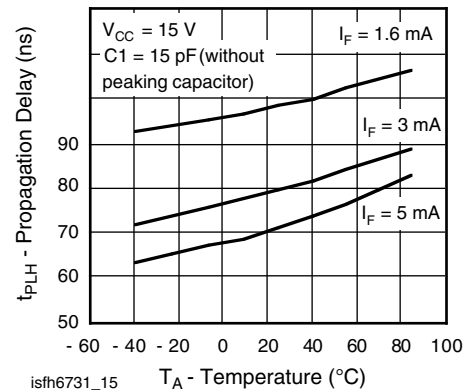

Fig. 15 - Typical Propagation Delays to Logic High vs. Temperature

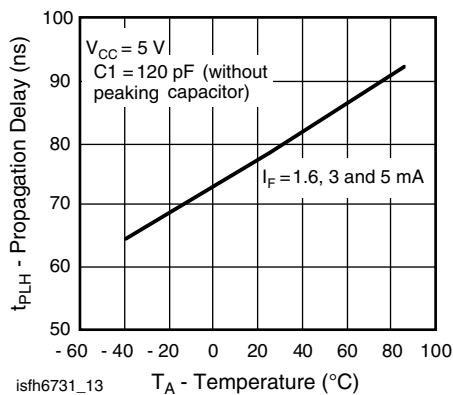

Fig. 13 - Typical Propagation Delays to Logic High vs. Temperature

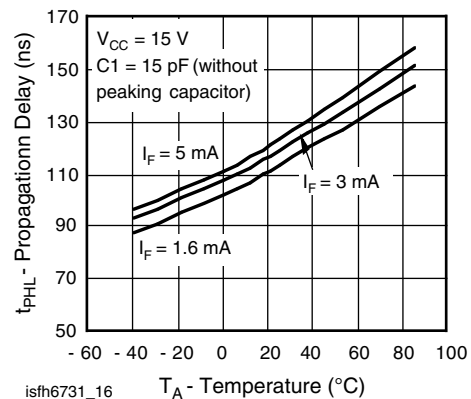

Fig. 16 - Typical Propagation Delays to Logic Low vs. Temperature

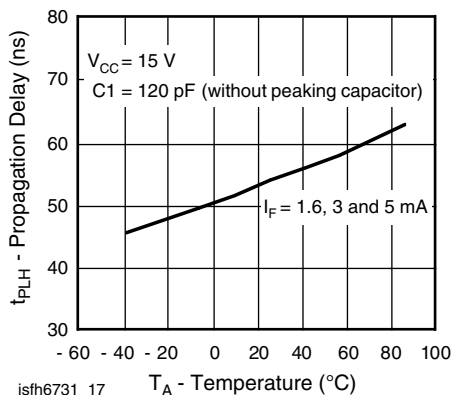

Fig. 17 - Typical Propagation Delays to Logic High vs. Temperature

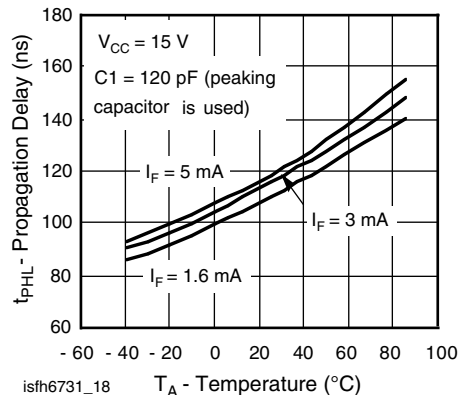
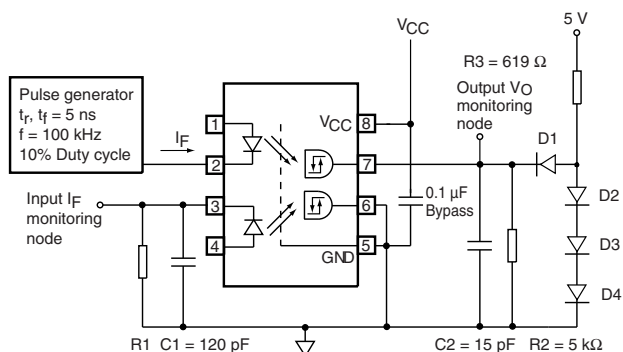

Fig. 18 - Typical Propagation Delays to Logic Low vs. Temperature



The Probe and Jig Capacitances are included in C1 and C2 All diodes are 1N916 or 1N3064

R1	2.15 kΩ	1.1 kΩ	681 Ω
I <sub>Fon</sub>	1.6 mA	3 mA	5 mA

Fig. 19 - Test Circuit for t<sub>PLH</sub>

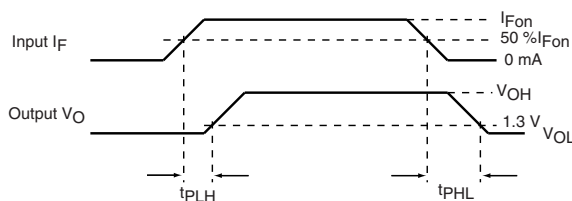

isfh6731\_19

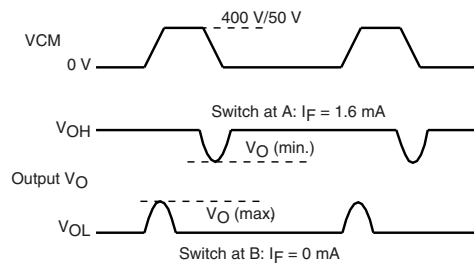
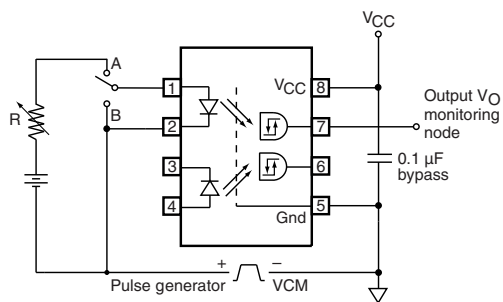

isfh6731\_20

Fig. 20 - Test Circuit for Common Mode Transient Immunity and Typical Waveforms



**PACKAGE DIMENSIONS** in millimeters

**Standard**

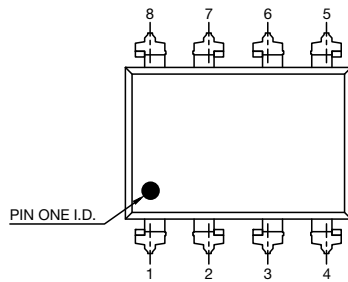
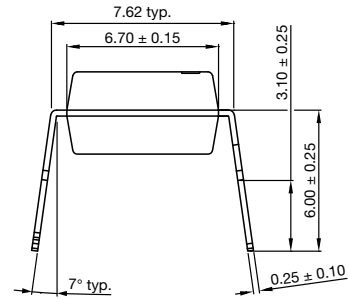
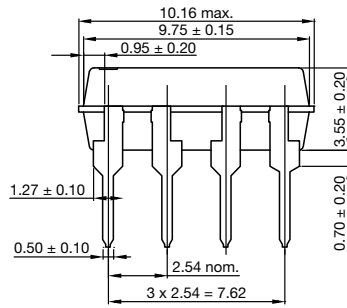

22672

**Option 6**

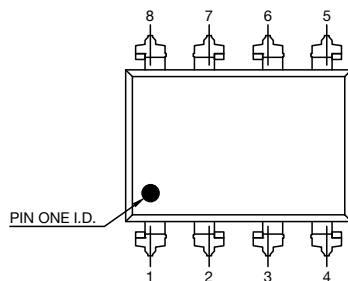
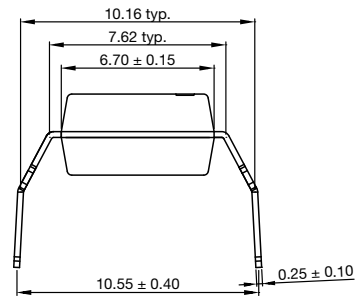
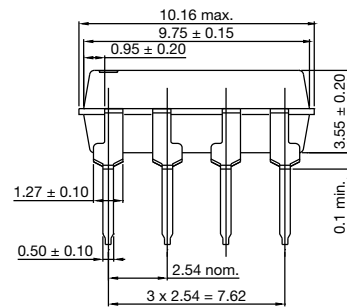

22673





Option 7

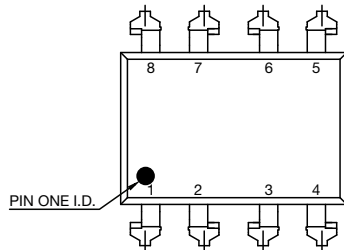
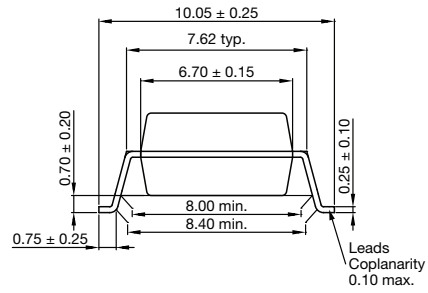
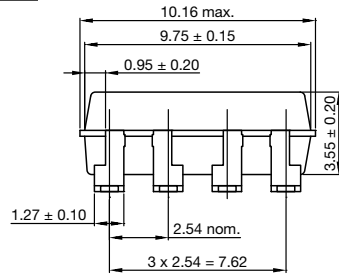

22674

PACKAGE MARKING (example)

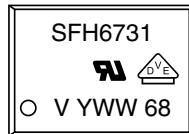

Notes

- The VDE logo is only marked on option 1 parts
- Tape and reel suffix (T) is not part of the package marking



## **Disclaimer**

ALL PRODUCT, PRODUCT SPECIFICATIONS AND DATA ARE SUBJECT TO CHANGE WITHOUT NOTICE TO IMPROVE RELIABILITY, FUNCTION OR DESIGN OR OTHERWISE.

Vishay Intertechnology, Inc., its affiliates, agents, and employees, and all persons acting on its or their behalf (collectively, "Vishay"), disclaim any and all liability for any errors, inaccuracies or incompleteness contained in any datasheet or in any other disclosure relating to any product.

Vishay makes no warranty, representation or guarantee regarding the suitability of the products for any particular purpose or the continuing production of any product. To the maximum extent permitted by applicable law, Vishay disclaims (i) any and all liability arising out of the application or use of any product, (ii) any and all liability, including without limitation special, consequential or incidental damages, and (iii) any and all implied warranties, including warranties of fitness for particular purpose, non-infringement and merchantability.

Statements regarding the suitability of products for certain types of applications are based on Vishay's knowledge of typical requirements that are often placed on Vishay products in generic applications. Such statements are not binding statements about the suitability of products for a particular application. It is the customer's responsibility to validate that a particular product with the properties described in the product specification is suitable for use in a particular application. Parameters provided in datasheets and / or specifications may vary in different applications and performance may vary over time. All operating parameters, including typical parameters, must be validated for each customer application by the customer's technical experts. Product specifications do not expand or otherwise modify Vishay's terms and conditions of purchase, including but not limited to the warranty expressed therein.

Hyperlinks included in this datasheet may direct users to third-party websites. These links are provided as a convenience and for informational purposes only. Inclusion of these hyperlinks does not constitute an endorsement or an approval by Vishay of any of the products, services or opinions of the corporation, organization or individual associated with the third-party website. Vishay disclaims any and all liability and bears no responsibility for the accuracy, legality or content of the third-party website or for that of subsequent links.

Except as expressly indicated in writing, Vishay products are not designed for use in medical, life-saving, or life-sustaining applications or for any other application in which the failure of the Vishay product could result in personal injury or death. Customers using or selling Vishay products not expressly indicated for use in such applications do so at their own risk. Please contact authorized Vishay personnel to obtain written terms and conditions regarding products designed for such applications.

No license, express or implied, by estoppel or otherwise, to any intellectual property rights is granted by this document or by any conduct of Vishay. Product names and markings noted herein may be trademarks of their respective owners.