

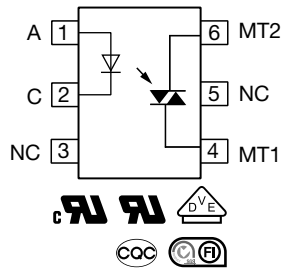

Optocoupler, Phototriac Output, Non-Zero Crossing, 250 V_{DRM}



22897-1



FEATURES

- 250 V blocking voltage
- Wide range of trigger current
- 100 mA_{RMS} on-state current
- Wide temperature range -55 °C to +100 °C
- Material categorization: for definitions of compliance please see www.vishay.com/doc?99912



RoHS COMPLIANT

LINKS TO ADDITIONAL RESOURCES



APPLICATIONS

- Power TRIAC driver
- Isolated AC load switch
- Air condition
- Heaters
- White goods
- Industrial controls
- Office equipment

DESCRIPTION

The K301xP series consists of a phototriac optically coupled to a gallium arsenide infrared-emitting diode in a 6-lead plastic dual inline package.

The non-zero crossing functionality enables full wave control. Featuring galvanic and electrical noise isolation, the output is able to directly switch AC loads or drive medium to high power TRIACs.

AGENCY APPROVALS

- [UL](#)
- [cUL](#)
- [DIN EN 60747-5-5 \(VDE 0884-5\)](#)
- [CQC: GB4943-1-2011](#)
- [CQC: GB8898-2011](#)
- [FIMKO](#)

ORDERING INFORMATION			
<div style="display: flex; justify-content: space-around; align-items: center;"> <div style="border: 1px solid black; padding: 2px 5px;">K</div> <div style="border: 1px solid black; padding: 2px 5px;">3</div> <div style="border: 1px solid black; padding: 2px 5px;">0</div> <div style="border: 1px solid black; padding: 2px 5px;">1</div> </div> <p style="text-align: center;">PART NUMBER</p>	<div style="border: 1px solid black; padding: 2px 5px;">X</div> <p>TRIGGER CURRENT I_{FT}</p>	<div style="border: 1px solid black; padding: 2px 5px;">P</div>	<p>DIP-6 7.62 mm</p>
AGENCY CERTIFIED / PACKAGE	TRIGGER CURRENT, I _{FT}		
VDE, cUL, BSI, CQC, FIMKO	5 mA	10 mA	15 mA
DIP-6	K3012P	K3011P	K3010P

Note

- Additional options may be possible, please contact sales office



ABSOLUTE MAXIMUM RATINGS ($T_{amb} = 25\text{ }^{\circ}\text{C}$, unless otherwise specified)				
PARAMETER	TEST CONDITION	SYMBOL	VALUE	UNIT
INPUT				
Reverse voltage		V_R	5	V
Forward current		I_F	80	mA
Forward surge current	$t_p \leq 10\text{ }\mu\text{s}$	I_{FSM}	3	A
Power dissipation		P_{diss}	100	mW
Junction temperature		T_j	125	$^{\circ}\text{C}$
OUTPUT				
Off state output terminal voltage		V_{DRM}	250	V
On state RMS current		I_{TRM}	100	mA
Peak surge current, non-repetitive	$t_p \leq 10\text{ ms}$	I_{TMS}	1.5	A
Power dissipation		P_{diss}	300	mW
Junction temperature		T_j	125	$^{\circ}\text{C}$
COUPLER				
Total power dissipation		P_{tot}	350	mW
Storage temperature range		T_{stg}	-55 to +150	$^{\circ}\text{C}$
Ambient temperature range		T_{amb}	-55 to +100	$^{\circ}\text{C}$
Soldering temperature	2 mm from case, $t \leq 10\text{ s}$	T_{sld}	260	$^{\circ}\text{C}$

Note

- Stresses in excess of the absolute maximum ratings can cause permanent damage to the device. Functional operation of the device is not implied at these or any other conditions in excess of those given in the operational sections of this document. Exposure to absolute maximum ratings for extended periods of the time can adversely affect reliability

ELECTRICAL CHARACTERISTICS ($T_{amb} = 25\text{ }^{\circ}\text{C}$, unless otherwise specified)							
PARAMETER	TEST CONDITION	PART	SYMBOL	MIN.	TYP.	MAX.	UNIT
INPUT							
Forward voltage	$I_F = 50\text{ mA}$		V_F	-	1.25	1.6	V
Junction capacitance	$V_R = 0$, $f = 1\text{ MHz}$		C_j	-	50	-	pF
OUTPUT							
Forward peak off-state voltage (repetitive)	$I_{RDM} = 100\text{ nA}$		$V_{DRM}^{(1)}$	250	-	-	V
Peak on-state voltage	$I_{TM} = 100\text{ mA}$		V_{TM}	-	1.5	3	V
Critical rate of rise of off-state voltage	$I_{FT} = 0$, $I_{FT} = 30\text{ mA}$		dV/dt_{cr}	-	10	-	V/ μs
			dV/dt_{crq}	0.1	0.2	-	V/ μs
COUPLER ⁽²⁾							
Collector emitter trigger current	$V_S = 3\text{ V}$, $R_L = 150\text{ }\Omega$	K3010P	I_{FT}	-	8	15	mA
		K3011P	I_{FT}	-	5	10	mA
		K3012P	I_{FT}	-	2	5	mA
Holding current	$I_F = 10\text{ mA}$, $V_S \geq 3\text{ V}$		I_H	-	100	-	μA

Notes

- Minimum and maximum values are testing requirements. Typical values are characteristics of the device and are the result of engineering evaluation. Typical values are for information only and are not part of the testing requirements

⁽¹⁾ Test voltage must be applied within dV/dt ratings

⁽²⁾ I_{FT} is defined as a minimum trigger current

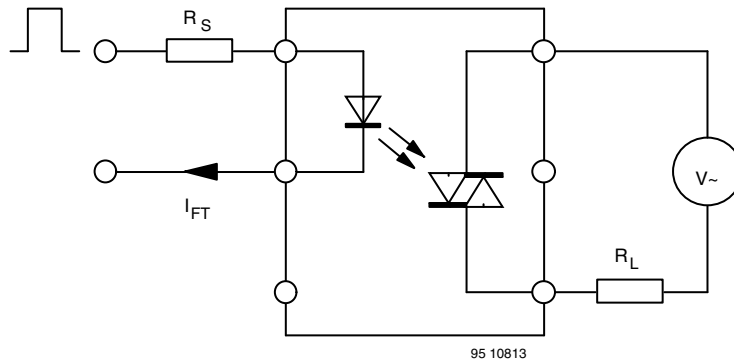

Test condition:
 dV/dt_{cr}
 $V_S = 2/3 V_{DRM}$
 (sine wave)
 $R_L = 33\text{ k}\Omega$
 dV/dt_{crq}
 $V_{eff} = 30\text{ V}$
 (sine wave)
 $R_L = 2\text{ k}\Omega$

Fig. 1 - Test Circuit for dV/dt_{cr} and dV/dt_{crq}

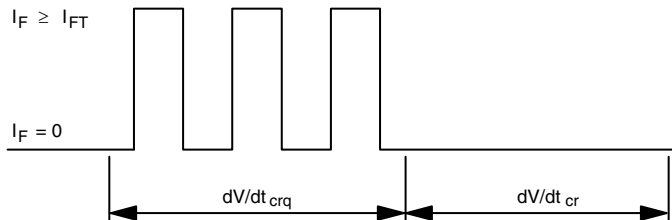

dV/dt_{cr} Highest value of the "rate of rise of off-state voltage" which does not cause any switching from the off state to the on state
 dV/dt_{crq} Highest value of the "rate of rise of communicating voltage" which does not switch on the device again, after the voltage has decreased to zero and the trigger current is switched from I_{FT} to zero

95 10814

Fig. 2

SAFETY AND INSULATION RATINGS ($T_{amb} = 25\text{ }^\circ\text{C}$, unless otherwise specified)				
PARAMETER	TEST CONDITION	SYMBOL	VALUE	UNIT
Climatic classification	According to IEC 68 part 1		55 / 100 / 21	
Pollution degree	According to DIN VDE 0109		2	
Comparative tracking index	Insulation group IIIa	CTI	175	
Maximum rated withstanding isolation voltage	According to UL1577, $t = 1\text{ min}$	V_{ISO}	4420	V_{RMS}
Tested withstanding isolation voltage	According to UL1577, $t = 1\text{ s}$	V_{ISO}	5300	V_{RMS}
Maximum transient isolation voltage	According to DIN EN 60747-5-5	V_{IOTM}	8000	V_{peak}
Maximum repetitive peak isolation voltage	According to DIN EN 60747-5-5	V_{IORM}	890	V_{peak}
Isolation resistance	$T_{amb} = 25\text{ }^\circ\text{C}$, $V_{IO} = 500\text{ V}$	R_{IO}	$\geq 10^{12}$	Ω
	$T_{amb} = 100\text{ }^\circ\text{C}$, $V_{IO} = 500\text{ V}$	R_{IO}	$\geq 10^{11}$	Ω
Output safety power		P_{SO}	265	mW
Input safety current		I_{SI}	130	mA
Input safety temperature		T_S	150	$^\circ\text{C}$
Creepage distance	DIP-6		≥ 7	mm
Clearance distance			≥ 7	mm
Insulation thickness		DTI	≥ 0.4	mm
Input to output test voltage, method A	$V_{IORM} \times 1.6 = V_{PR}$, 100 % sample test with $t_M = 10\text{ s}$, partial discharge $< 5\text{ pC}$	V_{PR}	1424	V_{peak}

Note

- According to DIN EN60747-5-5 (see figure 4). This optocoupler is suitable for safe electrical isolation only within the safety ratings. Compliance with the safety ratings shall be ensured by means of suitable protective circuits

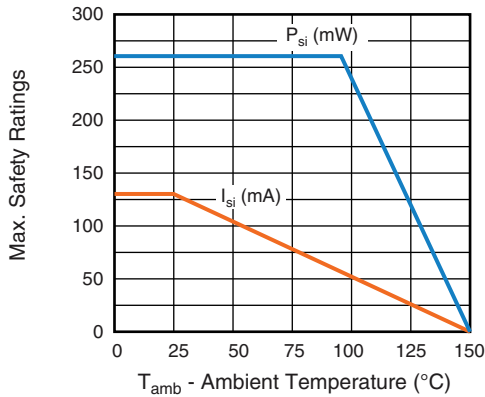

Fig. 3 - Safety Parameter Derating Diagram

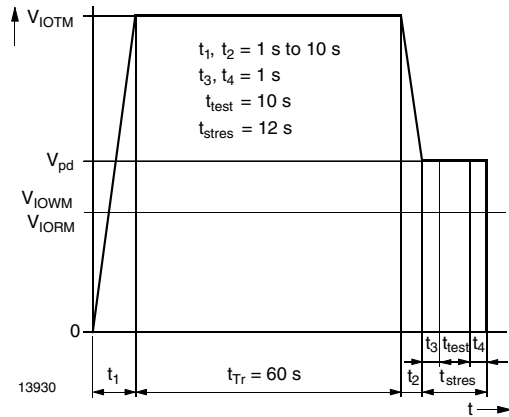

Fig. 4 - Test Pulse Diagram for Sample Test according to DIN EN60747-5-5 / DIN EN60747-; IEC 60747

TYPICAL CHARACTERISTICS ($T_{amb} = 25\text{ }^{\circ}\text{C}$, unless otherwise specified)

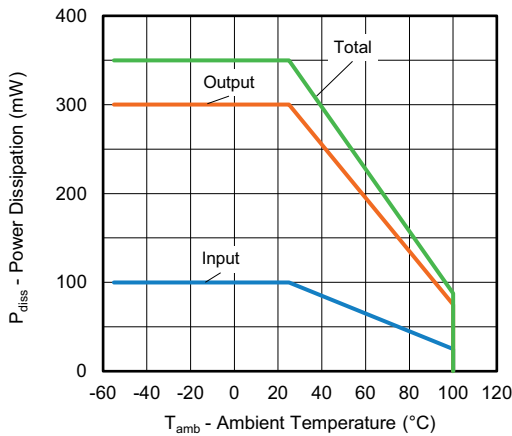

Fig. 5 - Total Power Dissipation vs. Ambient Temperature

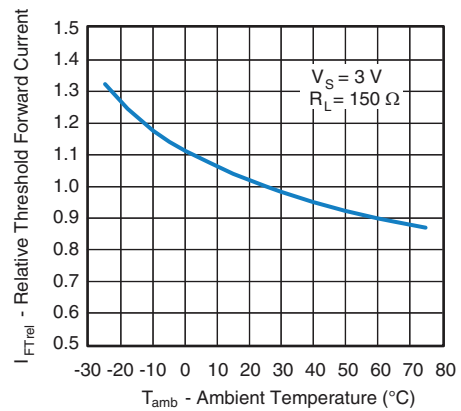

Fig. 7 - Relative Threshold Forward Current vs. Ambient Temperature

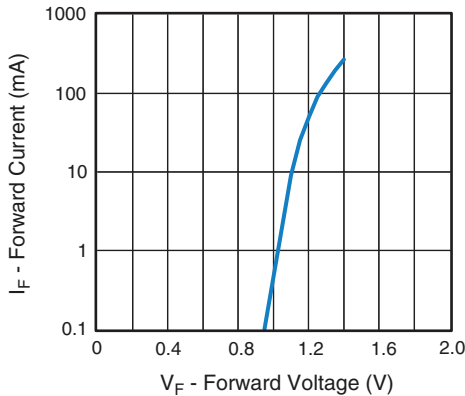

Fig. 6 - Forward Current vs. Forward Voltage

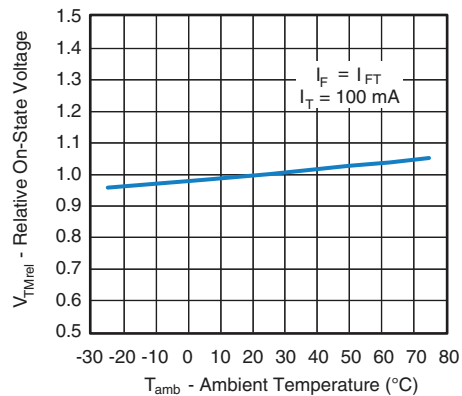

Fig. 8 - Relative On-State vs. Ambient Temperature

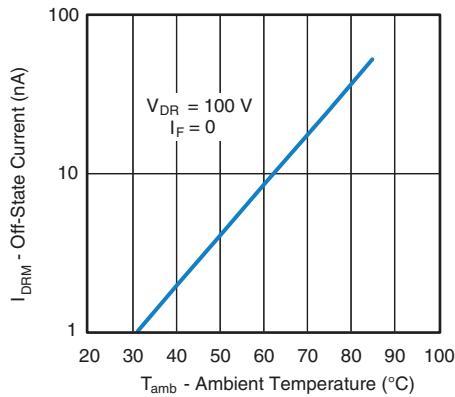

Fig. 9 - Off-State Current vs. Ambient Temperature

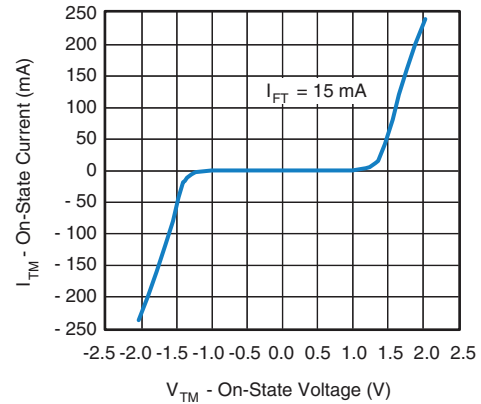
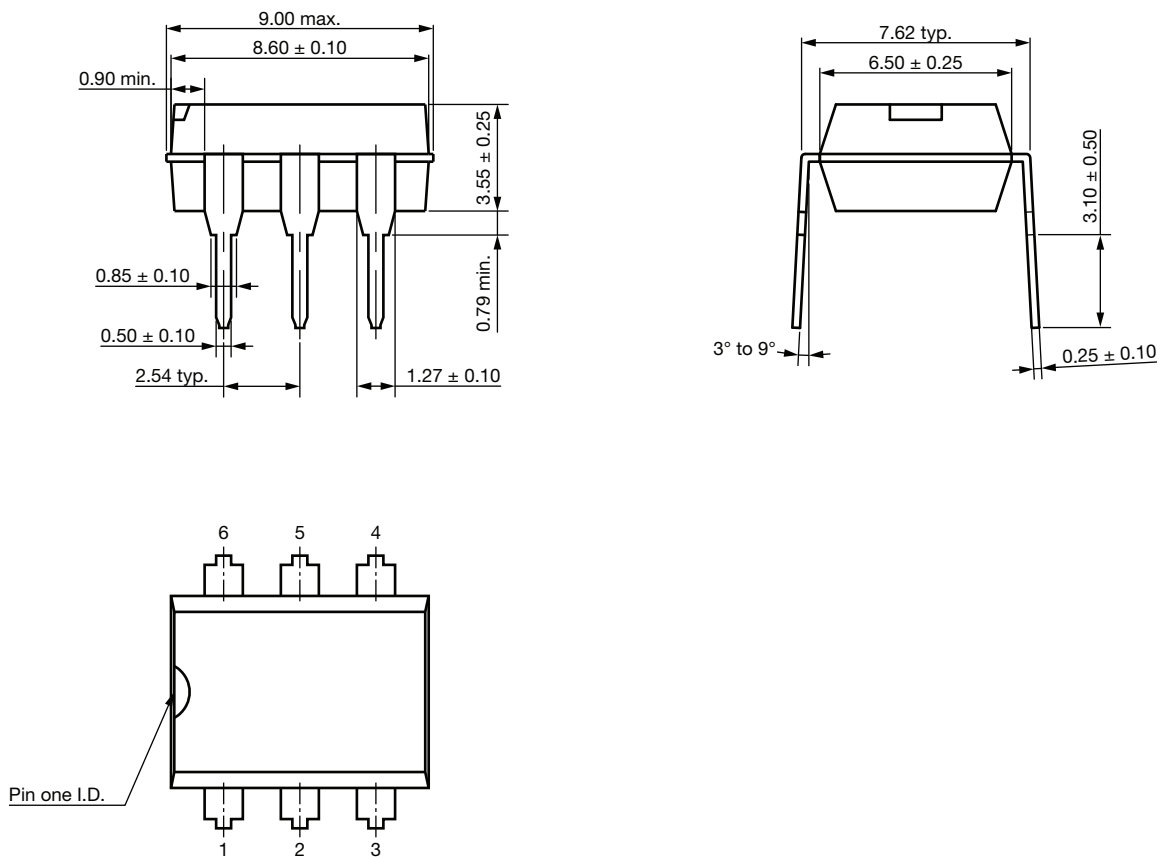

Fig. 10 - On-State Current vs. On-State Voltage

PACKAGE DIMENSIONS (in millimeters)

DIP-6



PACKAGE MARKING

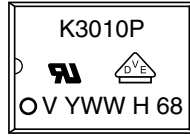

Fig. 11 - Example of K3010P

Notes

- The VDE logo is only marked on option1 parts

PACKING INFORMATION (in millimeters)

Tube

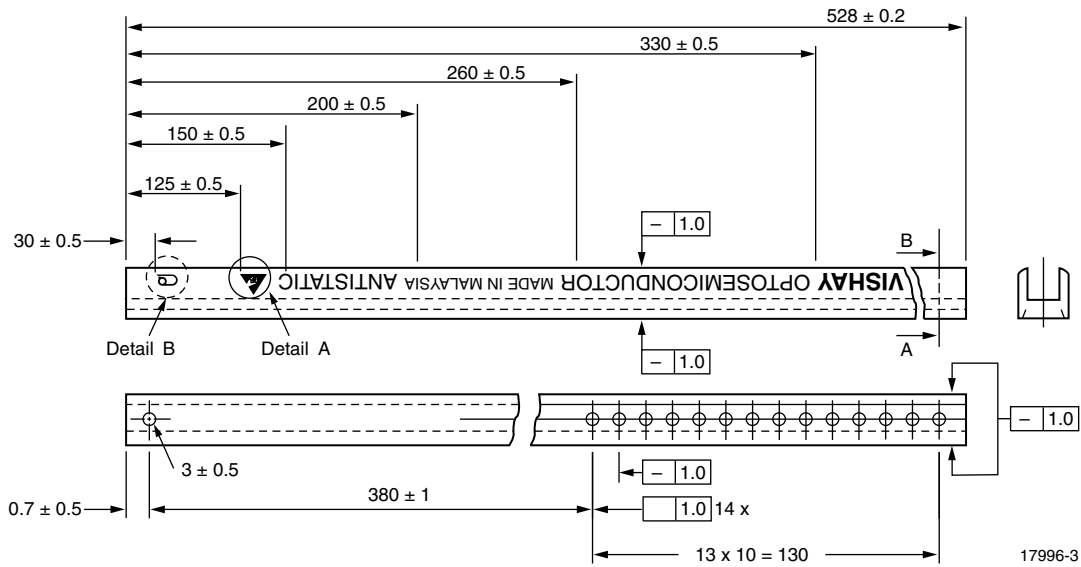

Fig. 12 - Shipping Tube Specifications for DIP Packages

DEVICES PER TUBES			
TYPE	UNITS/TUBE	TUBES/BOX	UNITS/BOX
DIP-6	50	40	2000

DIP-6

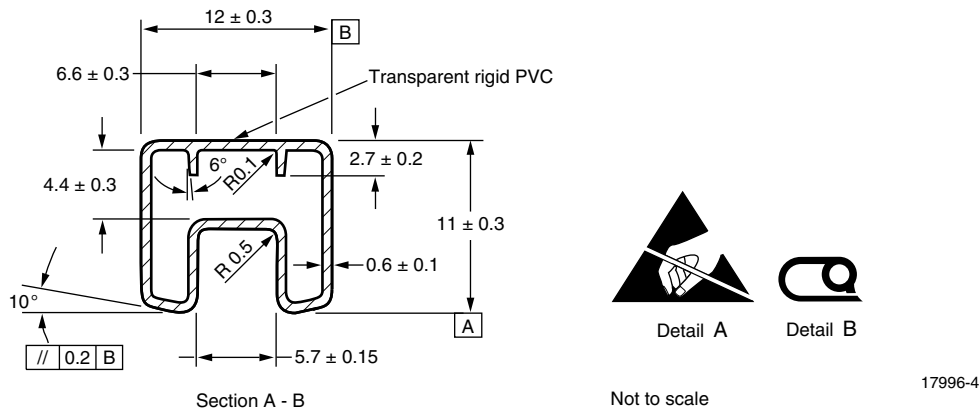
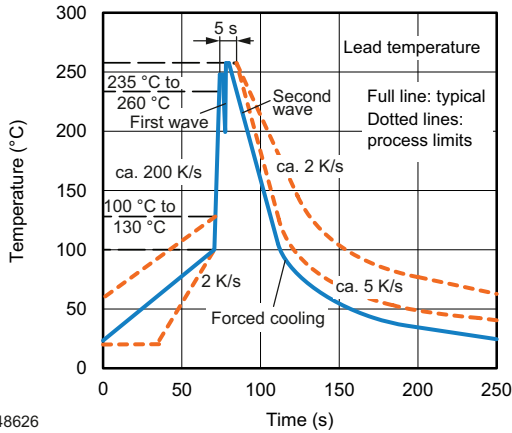

Fig. 13 - Tube Shipping Medium

SOLDER PROFILES



948626

Fig. 14 - Wave Soldering Double Wave Profile According to J-STD-020 for DIP Devices

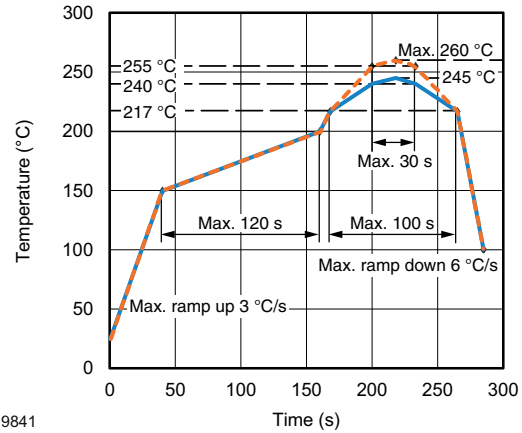

19841

Fig. 15 - Lead (Pb)-free Reflow Solder Profile According to J-STD-020 for SMD Devices

HANDLING AND STORAGE CONDITIONS

ESD level: HBM class 2

Floor life: unlimited

Conditions: $T_{amb} < 30\text{ }^{\circ}\text{C}$, RH < 85 %

Moisture sensitivity level 1, according to J-STD-020



Disclaimer

ALL PRODUCT, PRODUCT SPECIFICATIONS AND DATA ARE SUBJECT TO CHANGE WITHOUT NOTICE TO IMPROVE RELIABILITY, FUNCTION OR DESIGN OR OTHERWISE.

Vishay Intertechnology, Inc., its affiliates, agents, and employees, and all persons acting on its or their behalf (collectively, "Vishay"), disclaim any and all liability for any errors, inaccuracies or incompleteness contained in any datasheet or in any other disclosure relating to any product.

Vishay makes no warranty, representation or guarantee regarding the suitability of the products for any particular purpose or the continuing production of any product. To the maximum extent permitted by applicable law, Vishay disclaims (i) any and all liability arising out of the application or use of any product, (ii) any and all liability, including without limitation special, consequential or incidental damages, and (iii) any and all implied warranties, including warranties of fitness for particular purpose, non-infringement and merchantability.

Statements regarding the suitability of products for certain types of applications are based on Vishay's knowledge of typical requirements that are often placed on Vishay products in generic applications. Such statements are not binding statements about the suitability of products for a particular application. It is the customer's responsibility to validate that a particular product with the properties described in the product specification is suitable for use in a particular application. Parameters provided in datasheets and / or specifications may vary in different applications and performance may vary over time. All operating parameters, including typical parameters, must be validated for each customer application by the customer's technical experts. Product specifications do not expand or otherwise modify Vishay's terms and conditions of purchase, including but not limited to the warranty expressed therein.

Hyperlinks included in this datasheet may direct users to third-party websites. These links are provided as a convenience and for informational purposes only. Inclusion of these hyperlinks does not constitute an endorsement or an approval by Vishay of any of the products, services or opinions of the corporation, organization or individual associated with the third-party website. Vishay disclaims any and all liability and bears no responsibility for the accuracy, legality or content of the third-party website or for that of subsequent links.

Except as expressly indicated in writing, Vishay products are not designed for use in medical, life-saving, or life-sustaining applications or for any other application in which the failure of the Vishay product could result in personal injury or death. Customers using or selling Vishay products not expressly indicated for use in such applications do so at their own risk. Please contact authorized Vishay personnel to obtain written terms and conditions regarding products designed for such applications.

No license, express or implied, by estoppel or otherwise, to any intellectual property rights is granted by this document or by any conduct of Vishay. Product names and markings noted herein may be trademarks of their respective owners.