

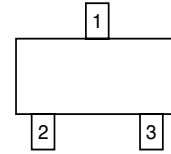

Silicon NPN Planar RF Transistor

Features

- Small feedback capacitance
- Low noise figure
- Low cross modulation
- Lead (Pb)-free component
- Component in accordance to RoHS 2002/95/EC and WEEE 2002/96/EC

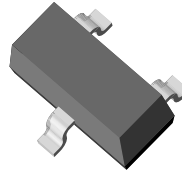

18991

Applications

RF amplifier up to 2 GHz, especially for mobile telephone.



Electrostatic sensitive device. Observe precautions for handling.

Mechanical Data

Case: SOT-23 Plastic case

Weight: approx. 8.8 mg

Pinning: 1 = Collector, 2 = Base, 3 = Emitter

Packaging Codes/Options:

GS08 / 3 k per 7" reel (8 mm tape), 15 k/box

Parts Table

Part	Ordering code	Marking	Remarks	Package
BFQ81	BFQ81-GS08	RA	Tape and Reel	SOT-23

Absolute Maximum Ratings

T_{amb} = 25 °C, unless otherwise specified

Parameter	Test condition	Symbol	Value	Unit
Collector-base voltage		V _{CBO}	25	V
Collector-emitter voltage		V _{CEO}	16	V
Emitter-base voltage		V _{EBO}	2	V
Collector current		I _C	30	mA
Total power dissipation	T _{amb} ≤ 60 °C	P _{tot}	200	mW
Junction temperature		T _j	150	°C
Storage temperature range		T _{stg}	- 65 to + 150	°C

Maximum Thermal Resistance

Parameter	Test condition	Symbol	Value	Unit
Junction ambient	1)	R _{thJA}	450	K/W

1) on glass fibre printed board (25 x 20 x 1.5) mm³ plated with 35 µm Cu

Electrical DC Characteristics

T_{amb} = 25 °C, unless otherwise specified

Parameter	Test condition	Symbol	Min	Typ.	Max	Unit
Collector-emitter cut-off current	V _{CE} = 25 V, V _{BE} = 0	I _{CES}			100	μA
Collector-base cut-off current	V _{CB} = 20 V, I _E = 0	I _{CBO}			100	nA
Emitter-base cut-off current	V _{EB} = 2 V, I _C = 0	I _{EBO}			10	μA
Collector-emitter breakdown voltage	I _C = 1 mA, I _B = 0	V _{(BR)CEO}	16			V
Collector-emitter saturation voltage	I _C = 30 mA, I _B = 3 mA	V _{CEsat}		0.2	0.5	V
DC forward current transfer ratio	V _{CE} = 10 V, I _C = 5 mA	h _{FE}	70	100	150	
	V _{CE} = 10 V, I _C = 15 mA	h _{FE}	70	100		

Electrical AC Characteristics

T_{amb} = 25 °C, unless otherwise specified

Parameter	Test condition	Symbol	Min	Typ.	Max	Unit
Transition frequency	V _{CE} = 10 V, I _C = 5 mA, f = 500 MHz	f _T		4.2		GHz
	V _{CE} = 10 V, I _C = 15 mA, f = 500 MHz	f _T		5.8		GHz
Collector-base capacitance	V _{CB} = 10 V, f = 1 MHz	C _{cb}		0.35		pF
Collector-emitter capacitance	V _{CE} = 10 V, f = 1 MHz	C _{ce}		0.2		pF
Emitter-base capacitance	V _{EB} = 0.5 V, f = 1 MHz	C _{eb}		1.1		pF
Noise figure	V _{CE} = 10 V, I _C = 5 mA, Z _S = 50 Ω, f = 800 MHz	F		1.4		dB
	V _{CE} = 10 V, I _C = 5 mA, Z _S = Z _{Sopt} , f = 2 GHz	F		2.5		dB
Power gain	V _{CE} = 10 V, I _C = 5 mA, Z _S = 50 Ω, Z _L = Z _{Lopt} , f = 800 MHz	G _{pe}		15		dB
Linear output voltage - two tone intermodulation test	V _{CE} = 10 V, I _C = 25 mA, d _{IM} = 60 dB, f ₁ = 806 MHz, f ₂ = 810 MHz, Z _S = Z _L = 50 Ω	V ₁ = V ₂		160		mV
Third order intercept point	V _{CE} = 10 V, I _C = 25 mA, f = 800 MHz	IP ₃		27		dBm

Common Emitter S-Parameters
 $Z_0 = 50 \Omega$, $T_{amb} = 25 \text{ }^\circ\text{C}$, unless otherwise specified

V_{CE}/V	I_C/mA	f/MHz	S11		S21		S12		S22	
			LIN MAG	ANG	LIN MAG	ANG	LIN MAG	ANG	LIN MAG	ANG
			deg		deg		deg		deg	
1	2	100	0.868	-29.7	6.78	157.2	0.045	72.3	0.939	-14.2
		300	0.681	-77.6	5.08	125.2	0.098	50.7	0.720	-30.3
		500	0.565	-109.5	3.77	106.3	0.120	42.0	0.576	-35.3
		800	0.491	-142.9	2.67	87.8	0.136	39.4	0.477	-37.3
		1000	0.478	-157.7	2.25	79.1	0.144	40.4	0.447	-38.7
		1200	0.472	-171.0	1.94	71.1	0.152	42.6	0.424	-40.8
		1500	0.480	173.1	1.64	60.8	0.168	46.6	0.399	-45.0
		1800	0.491	159.5	1.42	51.7	0.189	50.6	0.381	-50.4
		2000	0.506	151.7	1.32	46.8	0.208	52.6	0.368	-54.5
		2200	0.523	144.4	1.23	42.1	0.228	53.8	0.355	-59.0
		2500	0.554	133.5	1.13	35.3	0.262	54.3	0.340	-67.3
		2800	0.573	123.9	1.04	29.4	0.294	53.7	0.316	-76.1
		3000	0.600	117.4	0.97	26.3	0.315	53.0	0.305	-81.9
3	2	100	0.882	-24.8	6.74	160.3	0.032	74.9	0.958	-10.0
		300	0.709	-66.7	5.32	130.7	0.073	55.2	0.798	-22.2
		500	0.577	-97.2	4.09	111.8	0.092	46.8	0.680	-26.0
		800	0.477	-130.9	2.96	93.2	0.106	44.4	0.593	-27.9
		1000	0.450	-147.3	2.50	84.6	0.113	46.0	0.569	-29.2
		1200	0.432	-162.0	2.16	76.5	0.120	48.6	0.551	-30.9
		1500	0.433	179.7	1.83	66.4	0.134	53.8	0.531	-34.4
		1800	0.445	164.6	1.58	57.5	0.153	58.9	0.519	-38.5
		2000	0.459	156.0	1.45	52.6	0.169	61.4	0.511	-41.8
		2200	0.471	147.7	1.36	48.1	0.188	63.3	0.502	-45.2
		2500	0.501	136.4	1.24	41.2	0.220	64.8	0.495	-51.5
		2800	0.521	126.5	1.14	35.1	0.252	65.0	0.478	-58.3
		3000	0.543	119.1	1.07	32.2	0.275	64.5	0.471	-63.1
3	5	100	0.741	-38.2	13.66	150.6	0.028	70.6	0.890	-17.2
		300	0.497	-91.6	8.67	116.8	0.056	56.0	0.619	-28.6
		500	0.386	-122.9	5.90	100.7	0.072	55.6	0.504	-27.5
		800	0.332	-153.1	3.94	86.1	0.095	59.4	0.451	-25.3
		1000	0.324	-166.2	3.26	79.4	0.112	61.5	0.439	-25.4
		1200	0.323	-178.8	2.77	72.9	0.130	62.6	0.433	-26.6
		1500	0.333	167.3	2.30	64.6	0.156	63.8	0.422	-29.7
		1800	0.352	155.1	1.98	56.8	0.186	63.9	0.413	-33.7
		2000	0.367	147.8	1.82	52.5	0.206	63.4	0.406	-36.6
		2200	0.381	140.3	1.69	48.5	0.227	62.8	0.398	-39.8
		2500	0.414	131.2	1.54	42.3	0.256	61.4	0.389	-45.7
		2800	0.434	123.0	1.41	36.4	0.284	59.8	0.372	-52.0
		3000	0.459	116.9	1.32	33.2	0.303	58.8	0.364	-56.7
6	2	100	0.887	-23.2	6.76	161.2	0.026	76.4	0.966	-8.3

V _{CE} /V	I _C /mA	f/MHz	S11		S21		S12		S22	
			LIN MAG	ANG	LIN MAG	ANG	LIN MAG	ANG	LIN MAG	ANG
			deg		deg		deg		deg	
		300	0.725	-62.5	5.41	132.7	0.061	57.4	0.830	-18.6
		500	0.585	-92.0	4.23	114.0	0.078	49.3	0.728	-22.0
		800	0.473	-125.6	3.08	95.5	0.091	46.9	0.652	-23.7
		1000	0.437	-142.0	2.62	86.9	0.097	48.8	0.630	-24.9
		1200	0.416	-157.2	2.26	78.9	0.103	52.2	0.616	-26.6
		1500	0.410	-177.0	1.91	68.9	0.115	57.8	0.598	-30.0
		1800	0.416	167.2	1.64	59.9	0.133	63.7	0.589	-33.6
		2000	0.428	157.9	1.51	55.0	0.149	66.5	0.585	-36.6
		2200	0.446	149.4	1.41	50.8	0.167	68.9	0.580	-39.6
		2500	0.468	137.2	1.29	43.8	0.197	70.5	0.576	-45.2
		2800	0.492	127.1	1.18	37.6	0.228	71.0	0.562	-51.3
3000	0.514	119.9	1.10	34.2	0.251	70.7	0.555	-55.4		
6	5	100	0.758	-34.7	13.78	152.3	0.023	72.3	0.911	-14.1
		300	0.504	-84.6	9.02	118.9	0.048	57.9	0.675	-23.5
		500	0.378	-114.5	6.20	102.5	0.062	57.5	0.575	-22.6
		800	0.304	-146.3	4.17	87.9	0.083	61.7	0.527	-21.1
		1000	0.293	-160.6	3.44	81.2	0.097	63.8	0.518	-21.6
		1200	0.288	-173.5	2.93	74.8	0.112	65.5	0.513	-22.8
		1500	0.293	170.7	2.44	66.7	0.136	67.0	0.505	-25.9
		1800	0.310	157.4	2.08	59.1	0.163	67.9	0.498	-29.6
		2000	0.328	150.0	1.91	54.8	0.182	67.7	0.494	-32.4
		2200	0.341	142.7	1.79	50.7	0.201	67.4	0.488	-35.2
		2500	0.372	133.4	1.63	44.4	0.229	66.4	0.481	-40.6
		2800	0.397	124.4	1.49	38.3	0.257	64.9	0.463	-46.1
3000	0.425	118.0	1.39	34.8	0.274	63.9	0.454	-49.6		
6	10	100	0.594	-49.3	21.23	142.2	0.020	69.0	0.827	-19.7
		300	0.340	-105.4	11.25	108.9	0.040	63.8	0.558	-23.8
		500	0.262	-134.7	7.21	95.5	0.057	66.7	0.487	-19.8
		800	0.232	-163.7	4.71	83.8	0.084	69.8	0.466	-17.4
		1000	0.226	-174.6	3.85	78.1	0.102	70.8	0.467	-18.0
		1200	0.231	173.7	3.25	72.6	0.121	70.6	0.465	-19.6
		1500	0.243	161.8	2.70	65.3	0.148	69.9	0.461	-23.0
		1800	0.261	150.9	2.31	58.3	0.177	69.1	0.455	-26.8
		2000	0.282	145.1	2.11	54.5	0.197	67.9	0.450	-29.7
		2200	0.296	138.2	1.97	50.7	0.218	66.8	0.442	-32.5
		2500	0.326	130.8	1.79	44.8	0.246	64.8	0.434	-37.9
		2800	0.357	122.7	1.64	38.7	0.271	62.7	0.414	-43.0
3000	0.381	116.8	1.52	35.4	0.287	61.2	0.403	-46.2		
6	20	100	0.415	-68.7	27.88	131.7	0.017	68.66	0.728	-23.6



V _{CE} /V	I _C /mA	f/MHz	S11		S21		S12		S22	
			LIN MAG	ANG	LIN MAG	ANG	LIN MAG	ANG	LIN MAG	ANG
			deg		deg		deg		deg	
		300	0.245	-130.0	12.36	101.8	0.036	70.64	0.482	-20.7
		500	0.211	-156.3	7.69	90.9	0.055	73.69	0.445	-15.7
		800	0.203	-179.2	4.93	80.9	0.084	74.84	0.440	-13.9
		1000	0.204	172.3	4.03	75.9	0.105	74.36	0.445	-15.0
		1200	0.209	164.0	3.40	70.8	0.125	73.34	0.447	-17.0
		1500	0.228	154.3	2.81	64.0	0.154	71.71	0.444	-20.8
		1800	0.249	145.7	2.39	57.5	0.184	70.16	0.438	-24.8
		2000	0.266	141.1	2.20	53.7	0.204	68.50	0.432	-27.8
		2200	0.283	136.0	2.04	50.2	0.224	66.99	0.425	-30.7
		2500	0.313	128.2	1.86	44.3	0.253	64.48	0.414	-36.3
		2800	0.344	122.0	1.70	38.3	0.279	61.81	0.390	-41.5
3000	0.381	116.6	1.59	34.2	0.295	59.61	0.374	-44.3		
10	2	100	0.897	-22.3	6.81	161.7	0.023	76.6	0.970	-7.4
		300	0.732	-60.6	5.50	133.6	0.055	58.4	0.849	-16.7
		500	0.589	-89.4	4.31	114.9	0.070	50.3	0.753	-19.7
		800	0.465	-122.9	3.16	96.5	0.081	48.8	0.686	-21.4
		1000	0.430	-139.4	2.67	88.0	0.087	50.9	0.667	-22.7
		1200	0.403	-155.1	2.31	79.9	0.093	54.6	0.654	-24.2
		1500	0.396	-175.1	1.95	70.1	0.105	60.8	0.641	-27.2
		1800	0.398	168.9	1.68	61.3	0.122	66.9	0.634	-30.8
		2000	0.411	159.6	1.55	56.5	0.137	70.0	0.630	-33.5
		2200	0.426	150.5	1.45	52.0	0.155	72.5	0.628	-36.6
		2500	0.454	137.9	1.32	44.9	0.184	74.4	0.626	-41.9
		2800	0.480	128.4	1.21	38.6	0.215	74.8	0.611	-47.7
3000	0.507	121.3	1.13	34.5	0.237	73.9	0.598	-51.7		
10	5	100	0.774	-33.0	13.72	153.0	0.021	72.8	0.921	-12.4
		300	0.515	-80.6	9.14	120.0	0.044	59.0	0.709	-20.6
		500	0.379	-110.1	6.31	103.3	0.056	58.2	0.617	-19.9
		800	0.298	-141.4	4.24	88.7	0.075	62.7	0.577	-18.9
		1000	0.278	-156.2	3.51	82.1	0.088	65.4	0.569	-19.5
		1200	0.269	-170.2	2.98	75.7	0.102	67.3	0.564	-20.8
		1500	0.275	173.1	2.48	67.7	0.123	69.2	0.559	-23.8
		1800	0.288	159.7	2.12	60.1	0.148	70.5	0.554	-27.4
		2000	0.306	151.4	1.95	55.9	0.166	70.7	0.551	-30.0
		2200	0.322	143.9	1.82	51.9	0.184	70.7	0.547	-32.6
		2500	0.349	134.8	1.65	45.6	0.211	70.0	0.541	-37.9
		2800	0.377	126.0	1.52	39.3	0.239	68.7	0.524	-43.2
3000	0.408	119.5	1.42	35.2	0.257	67.4	0.512	-46.5		
10	10	100	0.625	-45.8	21.09	143.5	0.018	70.0	0.851	-16.9

V_{CE}/V	I_C/mA	f/MHz	S11		S21		S12		S22	
			LIN MAG	ANG	LIN MAG	ANG	LIN MAG	ANG	LIN MAG	ANG
			deg		deg		deg		deg	
		300	0.349	-99.0	11.39	109.9	0.037	63.8	0.605	-20.5
		500	0.259	-127.9	7.34	96.4	0.052	67.2	0.541	-17.1
		800	0.215	-157.9	4.79	84.5	0.075	70.7	0.523	-15.7
		1000	0.208	-170.0	3.92	79.0	0.092	71.8	0.524	-16.5
		1200	0.209	176.9	3.32	73.5	0.109	72.0	0.523	-18.0
		1500	0.222	163.8	2.75	66.3	0.134	71.9	0.520	-21.2
		1800	0.241	152.4	2.34	59.4	0.161	71.6	0.517	-24.9
		2000	0.256	145.9	2.15	55.5	0.180	70.7	0.514	-27.7
		2200	0.275	139.7	2.01	51.9	0.198	69.6	0.508	-30.6
		2500	0.304	131.6	1.82	45.8	0.225	68.4	0.502	-35.6
		2800	0.332	123.7	1.68	39.5	0.252	66.3	0.481	-40.7
3000	0.364	118.7	1.56	35.7	0.268	64.6	0.467	-43.8		
10	20	100	0.465	-63.2	27.66	133.0	0.015	68.1	0.762	-20.1
		300	0.249	-121.5	12.49	102.6	0.033	70.3	0.541	-17.3
		500	0.201	-148.9	7.77	91.7	0.050	73.6	0.509	-13.6
		800	0.189	-174.5	4.99	81.4	0.076	75.2	0.506	-12.7
		1000	0.188	175.6	4.07	76.6	0.094	75.3	0.511	-13.9
		1200	0.189	166.4	3.44	71.5	0.112	74.7	0.511	-15.9
		1500	0.206	155.9	2.84	65.0	0.138	73.7	0.510	-19.4
		1800	0.226	147.1	2.42	58.4	0.165	72.6	0.507	-23.3
		2000	0.244	141.7	2.22	54.7	0.184	71.4	0.504	-26.2
		2200	0.264	135.4	2.07	51.0	0.203	70.3	0.499	-28.9
		2500	0.297	128.6	1.88	45.2	0.230	68.4	0.492	-34.3
		2800	0.322	123.2	1.73	39.3	0.257	66.0	0.470	-39.5
3000	0.351	118.2	1.61	35.3	0.274	64.2	0.453	-42.8		

Typical Characteristics ($T_{amb} = 25\text{ }^\circ\text{C}$ unless otherwise specified)

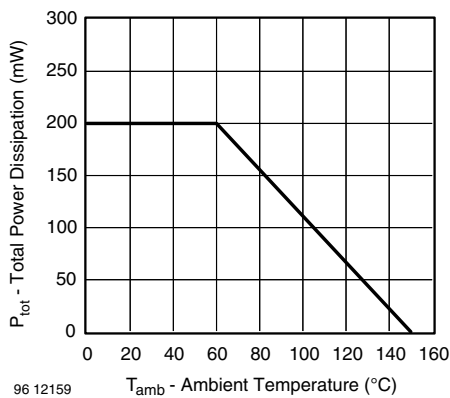

Figure 1. Total Power Dissipation vs. Ambient Temperature

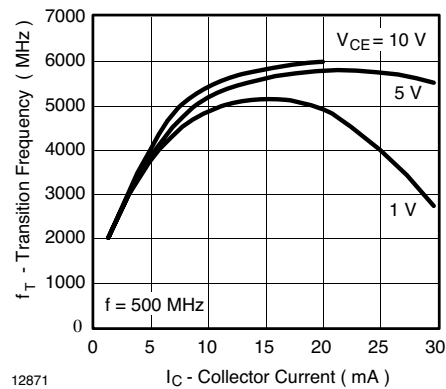

Figure 2. Transition Frequency vs. Collector Current

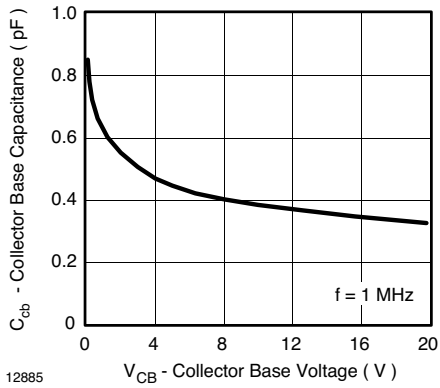

Figure 3. Collector Base Capacitance vs. Collector Base Voltage

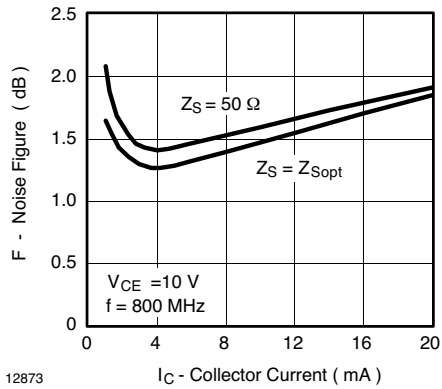

Figure 4. Noise Figure vs. Collector Current

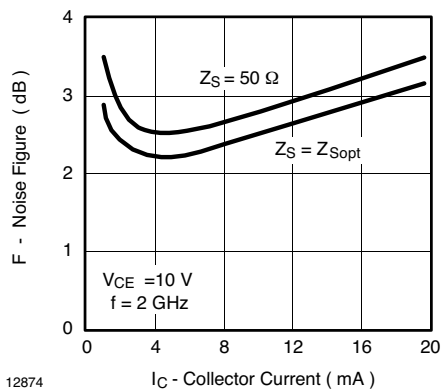

Figure 5. Noise Figure vs. Collector Current

$V_{CE} = 10\text{ V}$, $I_C = 10\text{ mA}$, $Z_0 = 50\ \Omega$

S_{11}

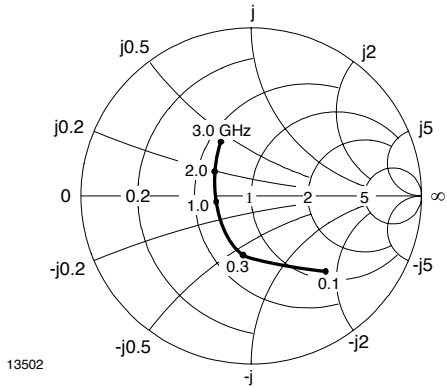

Figure 6. Input Reflection Coefficient

S_{12}

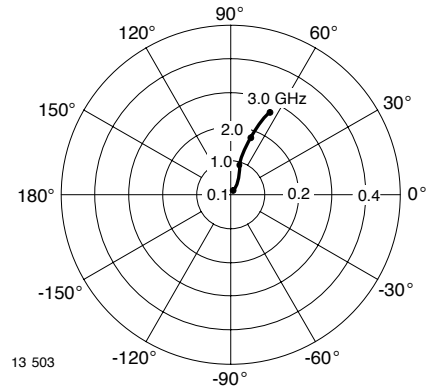

Figure 8. Reverse Transmission Coefficient

S_{21}

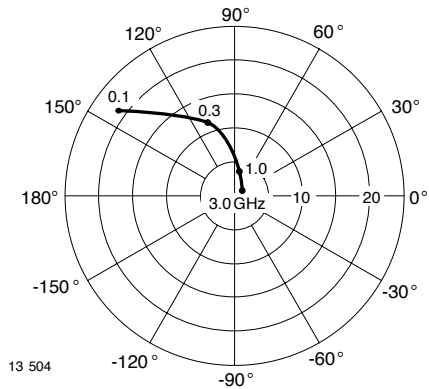

Figure 7. Forward Transmission Coefficient

S_{22}

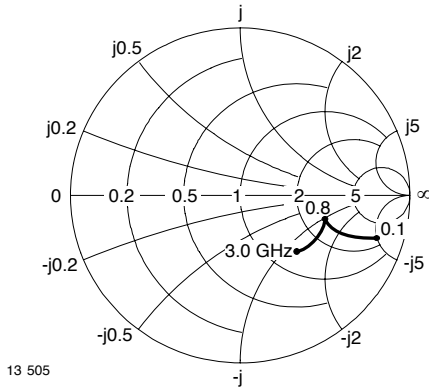
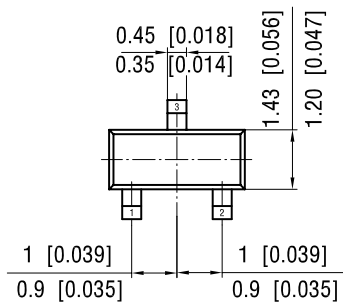
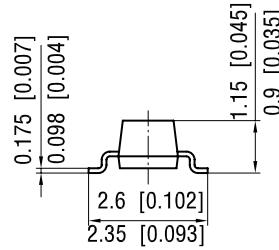
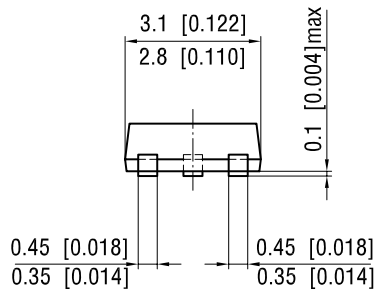
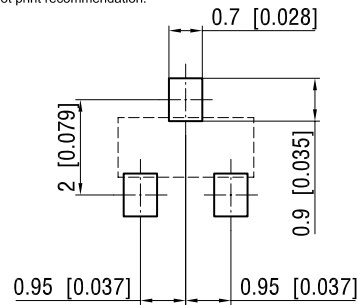

Figure 9. Output Reflection Coefficient

Package Dimensions in mm (Inches)



foot print recommendation:



Document no.: 6.541-5014.01-4
Rev. 7 - Date: 08.July.2004
17418

Ozone Depleting Substances Policy Statement

It is the policy of Vishay Semiconductor GmbH to

1. Meet all present and future national and international statutory requirements.
2. Regularly and continuously improve the performance of our products, processes, distribution and operating systems with respect to their impact on the health and safety of our employees and the public, as well as their impact on the environment.

It is particular concern to control or eliminate releases of those substances into the atmosphere which are known as ozone depleting substances (ODSs).

The Montreal Protocol (1987) and its London Amendments (1990) intend to severely restrict the use of ODSs and forbid their use within the next ten years. Various national and international initiatives are pressing for an earlier ban on these substances.

Vishay Semiconductor GmbH has been able to use its policy of continuous improvements to eliminate the use of ODSs listed in the following documents.

1. Annex A, B and list of transitional substances of the Montreal Protocol and the London Amendments respectively
2. Class I and II ozone depleting substances in the Clean Air Act Amendments of 1990 by the Environmental Protection Agency (EPA) in the USA
3. Council Decision 88/540/EEC and 91/690/EEC Annex A, B and C (transitional substances) respectively.

Vishay Semiconductor GmbH can certify that our semiconductors are not manufactured with ozone depleting substances and do not contain such substances.

We reserve the right to make changes to improve technical design
and may do so without further notice.

Parameters can vary in different applications. All operating parameters must be validated for each customer application by the customer. Should the buyer use Vishay Semiconductors products for any unintended or unauthorized application, the buyer shall indemnify Vishay Semiconductors against all claims, costs, damages, and expenses, arising out of, directly or indirectly, any claim of personal damage, injury or death associated with such unintended or unauthorized use.

Vishay Semiconductor GmbH, P.O.B. 3535, D-74025 Heilbronn, Germany



Disclaimer

All product specifications and data are subject to change without notice.

Vishay Intertechnology, Inc., its affiliates, agents, and employees, and all persons acting on its or their behalf (collectively, "Vishay"), disclaim any and all liability for any errors, inaccuracies or incompleteness contained herein or in any other disclosure relating to any product.

Vishay disclaims any and all liability arising out of the use or application of any product described herein or of any information provided herein to the maximum extent permitted by law. The product specifications do not expand or otherwise modify Vishay's terms and conditions of purchase, including but not limited to the warranty expressed therein, which apply to these products.

No license, express or implied, by estoppel or otherwise, to any intellectual property rights is granted by this document or by any conduct of Vishay.

The products shown herein are not designed for use in medical, life-saving, or life-sustaining applications unless otherwise expressly indicated. Customers using or selling Vishay products not expressly indicated for use in such applications do so entirely at their own risk and agree to fully indemnify Vishay for any damages arising or resulting from such use or sale. Please contact authorized Vishay personnel to obtain written terms and conditions regarding products designed for such applications.

Product names and markings noted herein may be trademarks of their respective owners.