

Product Summary

$V_{(BR)DSS}$	$R_{DS(ON)}$	I_D $T_A = +25^\circ\text{C}$
100V	6.0Ω @ $V_{GS} = 10\text{V}$	170mA

Description

This MOSFET is designed to minimize the on-state resistance ($R_{DS(ON)}$) and yet maintain superior switching performance, making it ideal for high efficiency power management applications.

Applications

- Small Servo Motor Control
- Power MOSFET Gate Drivers
- Switching Applications

Features

- Low Gate Threshold Voltage
- Low Input Capacitance
- Fast Switching Speed
- Low Input/Output Leakage
- High Drain-Source Voltage Rating
- **Totally Lead-Free & Fully RoHS compliant (Notes 1 & 2)**
- **Halogen and Antimony Free. "Green" Device (Note 3)**
- **For automotive applications requiring specific change control (i.e.: parts qualified to AEC-Q101, PPAP capable, and manufactured in IATF 16949 certified facilities), please refer to the related automotive grade (Q-suffix) part. A listing can be found at <https://www.diodes.com/products/automotive/automotive-products/>.**
- **This part is qualified to JEDEC standards (as references in AEC-Q101) for High Reliability. <https://www.diodes.com/quality/product-definitions/>**

Mechanical Data

- Case: SOT323
- Case Material: Molded Plastic, "Green" Molding Compound. UL Flammability Classification Rating 94V-0
- Moisture Sensitivity: Level 1 per J-STD-020
- Terminal Connections: See Diagram
- Terminals: Matte Tin Finish Annealed over Alloy 42 Leadframe (Lead Free Plating). Solderable per MIL-STD-202, Method 208③
- Weight: 0.006 grams (Approximate)

SOT323



Top View

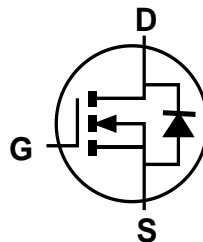

Equivalent Circuit

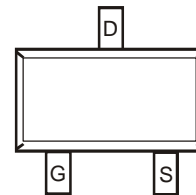

Top View

Ordering Information (Note 4)

Part Number	Compliance	Case	Packaging
BSS123W-7-F	Standard	SOT323	3000/Tape & Reel

- Notes:
1. No purposely added lead. Fully EU Directive 2002/95/EC (RoHS), 2011/65/EU (RoHS 2) & 2015/863/EU (RoHS 3) compliant.
 2. See <https://www.diodes.com/quality/lead-free/> for more information about Diodes Incorporated's definitions of Halogen- and Antimony-free, "Green" and Lead-free.
 3. Halogen- and Antimony-free "Green" products are defined as those which contain <900ppm bromine, <900ppm chlorine (<1500ppm total Br + Cl) and <1000ppm antimony compounds.
 4. For packaging details, go to our website at <https://www.diodes.com/design/support/packaging/diodes-packaging/>.

Marking Information

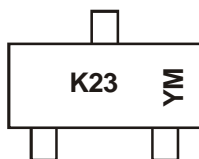

K23 = Product Type Marking Code
 YM = Date Code Marking
 Y or \bar{Y} = Year (ex: A = 2013)
 M = Month (ex: 9 = September)

Date Code Key

Year	2002	2003	2004	2005	2006	...	2012	2013	2014	2015	2016	2017	2018	2019
Code	N	P	R	S	T	...	Z	A	B	C	D	E	F	G

Month	Jan	Feb	Mar	Apr	May	Jun	Jul	Aug	Sep	Oct	Nov	Dec
Code	1	2	3	4	5	6	7	8	9	O	N	D

Maximum Ratings (@T_A = +25°C, unless otherwise specified.)

Characteristic	Symbol	Value	Units
Drain-Source Voltage	V _{DSS}	100	V
Drain-Gate Voltage R _{GS} ≤ 20KΩ	V _{DGR}	100	V
Gate-Source Voltage	V _{GSS}	±20	V
Drain Current (Note 5)	I _D	170	mA
	I _{DM}	680	

Thermal Characteristics (@T_A = +25°C, unless otherwise specified.)

Characteristic	Symbol	Value	Units
Total Power Dissipation (Note 5)	P _D	200	mW
Thermal Resistance, Junction to Ambient (Note 5)	R _{θJA}	625	°C/W
Operating and Storage Temperature Range	T _J , T _{STG}	-55 to +150	°C

Electrical Characteristics (@T_A = +25°C, unless otherwise specified.)

Characteristic	Symbol	Min	Typ	Max	Unit	Test Condition
OFF CHARACTERISTICS (Note 6)						
Drain-Source Breakdown Voltage	BV _{DSS}	100	—	—	V	V _{GS} = 0V, I _D = 250μA
Zero Gate Voltage Drain Current	I _{DSS}	—	—	1.0 10	μA nA	V _{DS} = 100V, V _{GS} = 0V V _{DS} = 20V, V _{GS} = 0V
Gate-Body Leakage, Forward	I _{GSSF}	—	—	50	nA	V _{GS} = 20V, V _{DS} = 0V
ON CHARACTERISTICS (Note 6)						
Gate Threshold Voltage	V _{GS(th)}	0.8	1.4	2.0	V	V _{DS} = V _{GS} , I _D = 1mA
Static Drain-Source On-Resistance	R _{DS(ON)}	—	—	6.0 10	Ω	V _{GS} = 10V, I _D = 0.17A V _{GS} = 4.5V, I _D = 0.17A
Forward Transconductance	g _{FS}	80	370	—	mS	V _{DS} = 10V, I _D = 0.17A, f = 1.0KHz
Drain-Source Diode Forward Voltage	V _{SD}	—	0.84	1.3	V	V _{GS} = 0V, I _S = 0.34A
DYNAMIC CHARACTERISTICS (Note 7)						
Input Capacitance	C _{iss}	—	29	60	pF	V _{DS} = 25V, V _{GS} = 0V, f = 1.0MHz
Output Capacitance	C _{oss}	—	10	15	pF	
Reverse Transfer Capacitance	C _{rss}	—	2	6	pF	
SWITCHING CHARACTERISTICS (Note 7)						
Turn-On Rise Time	t _r	—	—	8	ns	V _{DD} = 30V, I _D = 0.28A, R _{GEN} = 6.0Ω, V _{GS} = 10V
Turn-Off Fall Time	t _f	—	—	16	ns	
Turn-On Delay Time	t _{D(ON)}	—	—	8	ns	
Turn-Off Delay Time	t _{D(OFF)}	—	—	13	ns	

Notes: 5. Part mounted on FR-4 board with recommended pad layout, which can be found on our website at <http://www.diodes.com>.
 6. Short duration pulse test used to minimize self-heating effect.
 7. Guaranteed by design. Not subject to production testing.

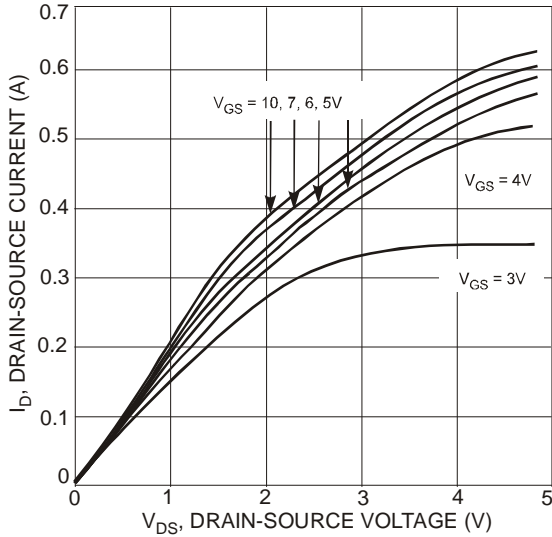

Fig. 1 On-Region Characteristics

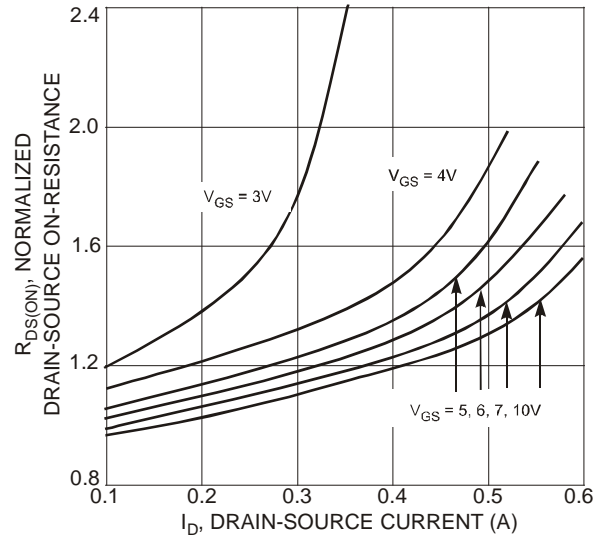

Fig. 2 On-Resistance Variation with Gate Voltage and Drain-Source Current

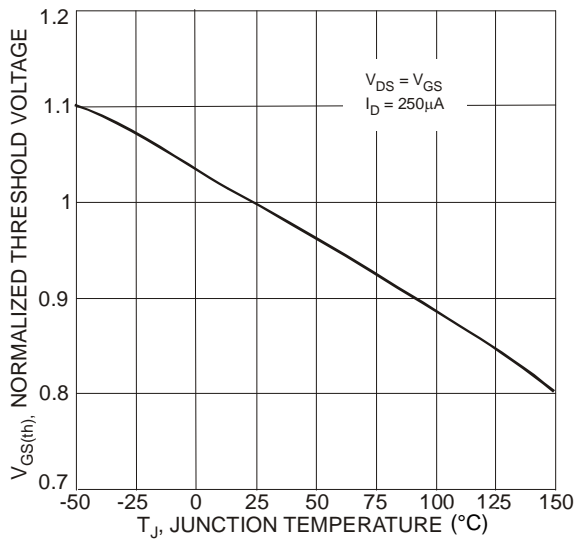

Fig. 3 Gate Threshold Variation with Temperature

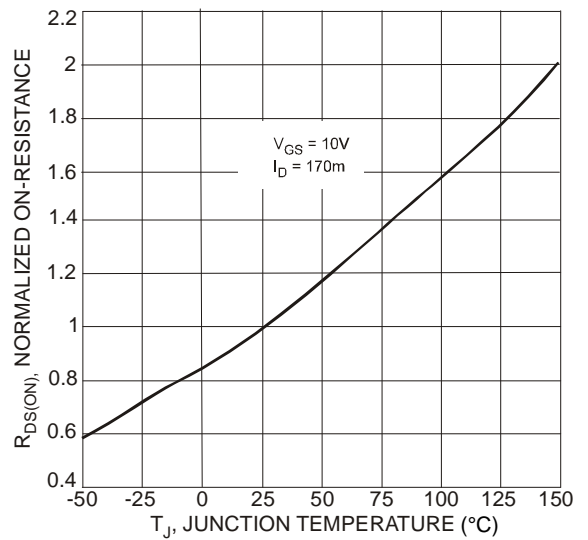

Fig. 4 On-Resistance Variation with Temperature

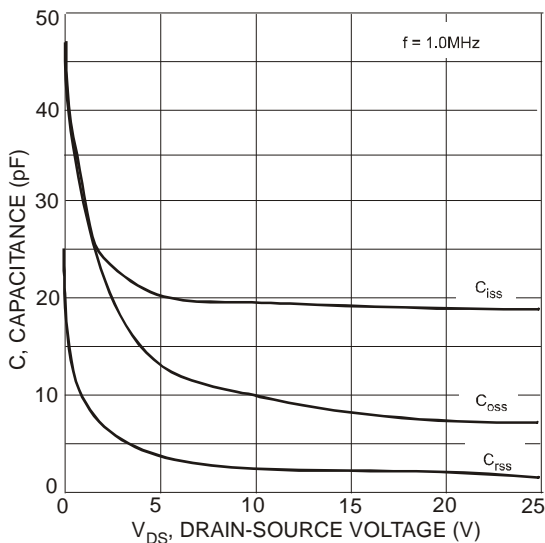

Fig. 5 Typical Capacitance

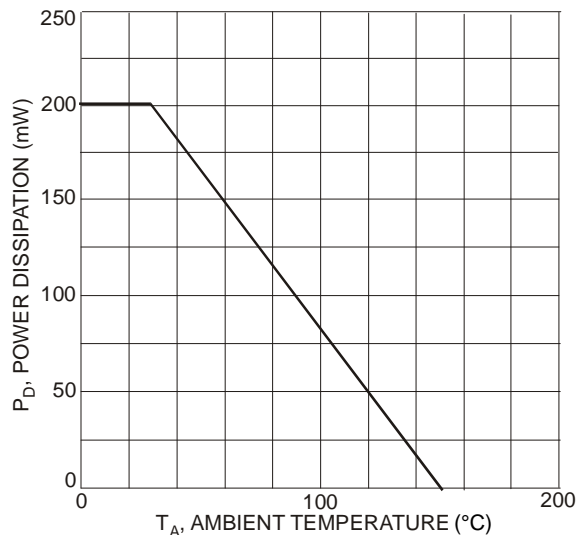
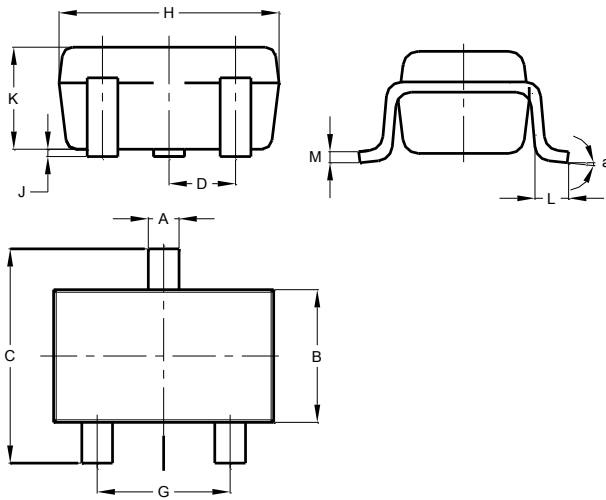

Fig. 6 Power Derating Curve, Total Package

Package Outline Dimensions

Please see <http://www.diodes.com/package-outlines.html> for the latest version.



SOT323			
Dim	Min	Max	Typ
A	0.25	0.40	0.30
B	1.15	1.35	1.30
C	2.00	2.20	2.10
D	0.650 BSC		
F	0.375	0.475	0.425
G	1.20	1.40	1.30
H	1.80	2.20	2.15
J	0.00	0.10	0.05
K	0.90	1.00	0.95
L	0.25	0.40	0.30
M	0.10	0.18	0.11
a	8° C		
All Dimensions in mm			

Suggested Pad Layout

Please see <http://www.diodes.com/package-outlines.html> for the latest version.

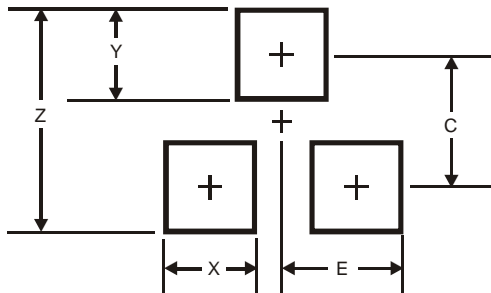

Dimensions	Value (in mm)
Z	2.8
X	0.7
Y	0.9
C	1.9
E	1.0

IMPORTANT NOTICE

DIODES INCORPORATED MAKES NO WARRANTY OF ANY KIND, EXPRESS OR IMPLIED, WITH REGARDS TO THIS DOCUMENT, INCLUDING, BUT NOT LIMITED TO, THE IMPLIED WARRANTIES OF MERCHANTABILITY AND FITNESS FOR A PARTICULAR PURPOSE (AND THEIR EQUIVALENTS UNDER THE LAWS OF ANY JURISDICTION).

Diodes Incorporated and its subsidiaries reserve the right to make modifications, enhancements, improvements, corrections or other changes without further notice to this document and any product described herein. Diodes Incorporated does not assume any liability arising out of the application or use of this document or any product described herein; neither does Diodes Incorporated convey any license under its patent or trademark rights, nor the rights of others. Any Customer or user of this document or products described herein in such applications shall assume all risks of such use and will agree to hold Diodes Incorporated and all the companies whose products are represented on Diodes Incorporated website, harmless against all damages.

Diodes Incorporated does not warrant or accept any liability whatsoever in respect of any products purchased through unauthorized sales channel. Should Customers purchase or use Diodes Incorporated products for any unintended or unauthorized application, Customers shall indemnify and hold Diodes Incorporated and its representatives harmless against all claims, damages, expenses, and attorney fees arising out of, directly or indirectly, any claim of personal injury or death associated with such unintended or unauthorized application.

Products described herein may be covered by one or more United States, international or foreign patents pending. Product names and markings noted herein may also be covered by one or more United States, international or foreign trademarks.

This document is written in English but may be translated into multiple languages for reference. Only the English version of this document is the final and determinative format released by Diodes Incorporated.

LIFE SUPPORT

Diodes Incorporated products are specifically not authorized for use as critical components in life support devices or systems without the express written approval of the Chief Executive Officer of Diodes Incorporated. As used herein:

A. Life support devices or systems are devices or systems which:

1. are intended to implant into the body, or
2. support or sustain life and whose failure to perform when properly used in accordance with instructions for use provided in the labeling can be reasonably expected to result in significant injury to the user.

B. A critical component is any component in a life support device or system whose failure to perform can be reasonably expected to cause the failure of the life support device or to affect its safety or effectiveness.

Customers represent that they have all necessary expertise in the safety and regulatory ramifications of their life support devices or systems, and acknowledge and agree that they are solely responsible for all legal, regulatory and safety-related requirements concerning their products and any use of Diodes Incorporated products in such safety-critical, life support devices or systems, notwithstanding any devices- or systems-related information or support that may be provided by Diodes Incorporated. Further, Customers must fully indemnify Diodes Incorporated and its representatives against any damages arising out of the use of Diodes Incorporated products in such safety-critical, life support devices or systems.

Copyright © 2019, Diodes Incorporated

www.diodes.com