

**2.0A SURFACE MOUNT FAST GLASS PASSIVATED BRIDGE RECTIFIER**

NEW PRODUCT

**Product Summary** (@T<sub>A</sub> = +25°C)

V <sub>RRM</sub> (V)	I <sub>O</sub> (A)	V <sub>F</sub> (V)	I <sub>R</sub> (μA)
200, 400, 600, 800, 1000	2.0	1.3	5

**Features and Benefits**

- Glass Passivated Die Construction
- Miniature Surface Mount Package Saves Space on PC Boards
- High Current Capability
- Fast Reverse Recovery Time Suitable for High Frequency Applications
- Low Forward Voltage Drop
- **Lead-Free Finish; RoHS Compliant (Notes 1 & 2)**
- **Halogen and Antimony Free. "Green" Device (Note 3)**

**Description and Applications**

Suitable for AC to DC bridge full wave rectification for SMPS, LED lighting, adapter, battery charger, home appliances, office equipment, and telecommunication applications.

**Mechanical Data**

- Case: SOPA-4 (Type B)
- Case Material: Molded Plastic. UL Flammability Classification Rating 94V-0
- Moisture Sensitivity: Level 1 per J-STD-020
- Terminals: Lead Free Plating (Matte Tin Finish). Solderable per MIL-STD-202, Method 208 Ⓔ3
- Polarity: As marked on Body
- Weight: 0.089 grams (Approximate)



Top View

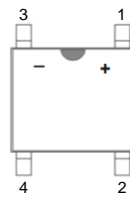

Pin Diagram

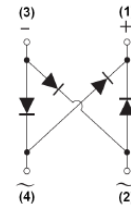

Internal Schematic

**Ordering Information** (Note 4)

Part Number	Compliance	Case	Packaging
RABF210-13	Commercial	SOPA-4 (Type B)	5,000/Tape & Reel
RABF28-13	Commercial	SOPA-4 (Type B)	5,000/Tape & Reel
RABF26-13	Commercial	SOPA-4 (Type B)	5,000/Tape & Reel
RABF24-13	Commercial	SOPA-4 (Type B)	5,000/Tape & Reel
RABF22-13	Commercial	SOPA-4 (Type B)	5,000/Tape & Reel

- Notes:
1. EU Directive 2002/95/EC (RoHS), 2011/65/EU (RoHS 2) & 2015/863/EU (RoHS 3) compliant. All applicable RoHS exemptions applied.
  2. See <https://www.diodes.com/quality/lead-free/> for more information about Diodes Incorporated's definitions of Halogen- and Antimony-free, "Green" and Lead-free.
  3. Halogen- and Antimony-free "Green" products are defined as those which contain <900ppm bromine, <900ppm chlorine (<1500ppm total Br + Cl) and <1000ppm antimony compounds.
  4. For packaging details, go to our website at <https://www.diodes.com/design/support/packaging/diodes-packaging/>.

**Marking Information**

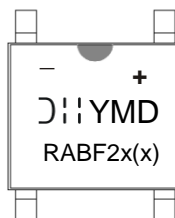

RABF2x(x) = Product Type Marking Code  
 311 = Manufacturers' Code Marking  
 YMD = Date Code Marking  
 Y = Last Digit of Year (ex: 8 = 2018)  
 M = See Month/Code Table Below  
 D = Day 1 to 9 = 1 to 9; Day 10 to 31 = A to V

Month	Jan	Feb	Mar	Apr	May	Jun	Jul	Aug	Sep	Oct	Nov	Dec
Code	1	2	3	4	5	6	7	8	9	O	N	D

### Maximum Ratings and Electrical Characteristics (@T<sub>A</sub> = +25°C, unless otherwise specified.)

Single phase, half wave, 60Hz, resistive or inductive load.  
 For capacitive load, derate current by 20%.

Characteristic	Symbol	RABF22	RABF24	RABF26	RABF28	RABF210	Unit
Peak Repetitive Reverse Voltage Working Peak Reverse Voltage DC Blocking Voltage	V <sub>RRM</sub> V <sub>RWM</sub> V <sub>R</sub>	200	400	600	800	1000	V
RMS Reverse Voltage	V <sub>R(RMS)</sub>	140	280	420	560	700	V
Average Rectified Output Current (Note 5) @ T <sub>C</sub> = +100°C	I <sub>O</sub>	2.0					A
Non-Repetitive Peak Forward Surge Current, 8.3ms Single Half Sine-Wave Superimposed on Rated Load	I <sub>FSM</sub>	60					A
I <sup>2</sup> t Rating for Fusing (1ms < t < 8.3ms)	I <sup>2</sup> t	14.94					A <sup>2</sup> S
Maximum Forward Voltage (Per Element) @ I <sub>F</sub> = 2.0A	V <sub>FM</sub>	1.3					V
Maximum Reverse Recovery Time (Note 6)	t <sub>RR</sub>	150	250	500			ns
Peak Reverse Current @ T <sub>A</sub> = +25°C At Rated DC Blocking Voltage (Note 7) @ T <sub>A</sub> = +125°C	I <sub>R</sub>	5.0 200					μA
Typical Total Capacitance (Per Element) (Note 8)	C <sub>T</sub>	17					ns

### Thermal Characteristics

Characteristic	Symbol	Value	Unit
Typical Thermal Resistance, Junction to Ambient (Note 5) (Per Element)	R <sub>θJA</sub>	63	°C/W
Typical Thermal Resistance, Junction to Lead (Per Element)	R <sub>θJL</sub>	25	°C/W
Operating and Storage Temperature Range	T <sub>J</sub> , T <sub>STG</sub>	-55 to +150	°C

- Notes:
5. Device mounted on aluminum substrate PC board with 1.3mm<sup>2</sup> solder pad.
  6. Reverse Recovery Test Conditions: I<sub>F</sub> = 0.5A, I<sub>R</sub> = 1.0A, I<sub>RR</sub> = 0.25A.
  7. Short duration pulse test used to minimize self-heating effect.
  8. Measured at 1.0MHz and applied reverse voltage of 4.0V D.C.

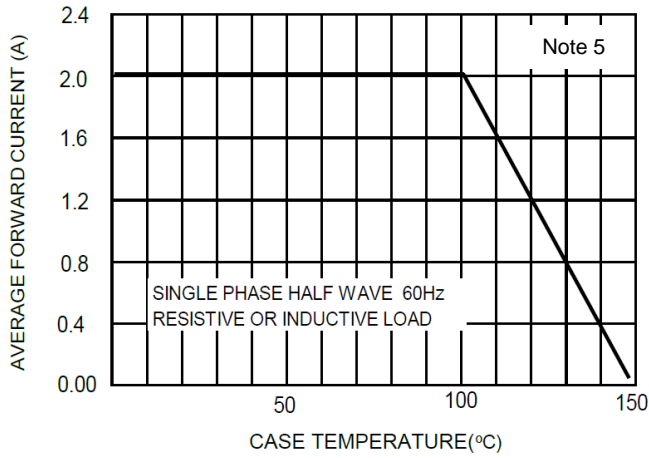

Figure 1. Forward Current Derating

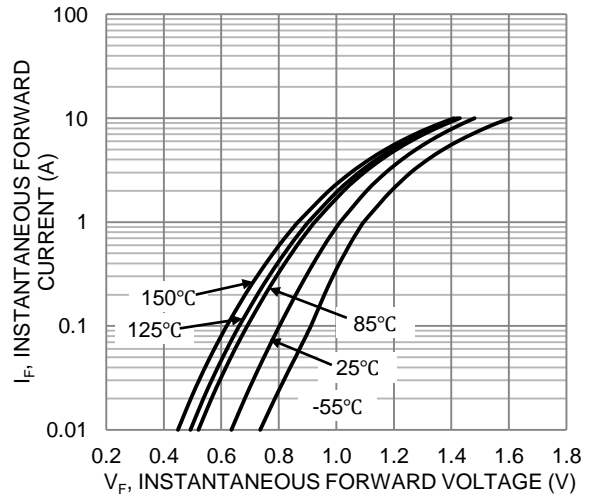

Figure 2. Typical Forward Characteristics

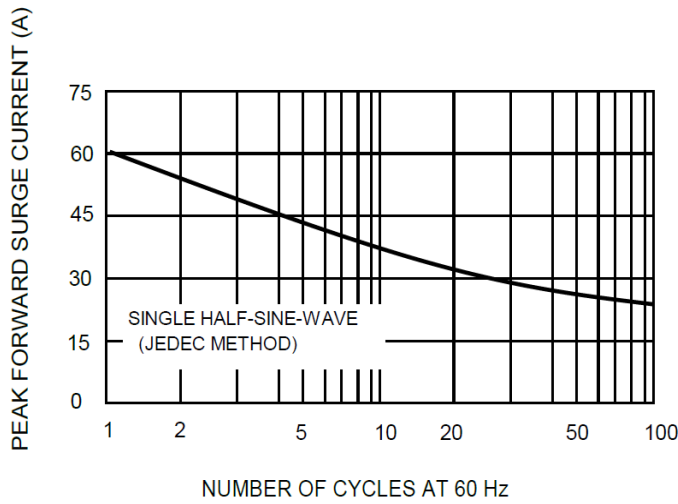

Figure 3. Maximum Non-Repetitive Forward Surge Current

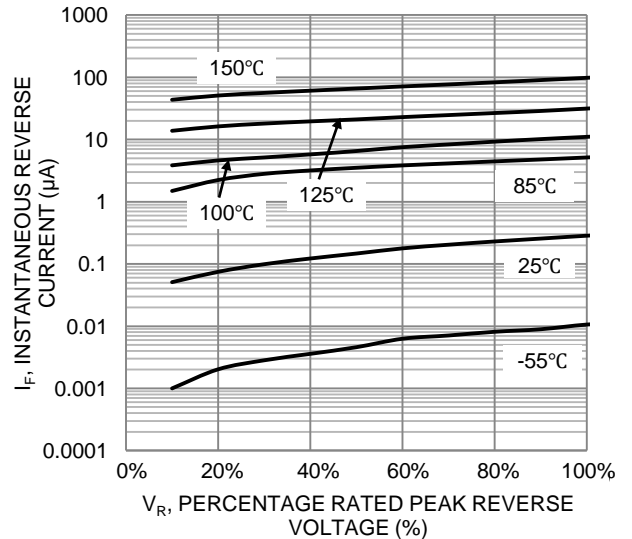

Figure 4. Typical Reverse Characteristics

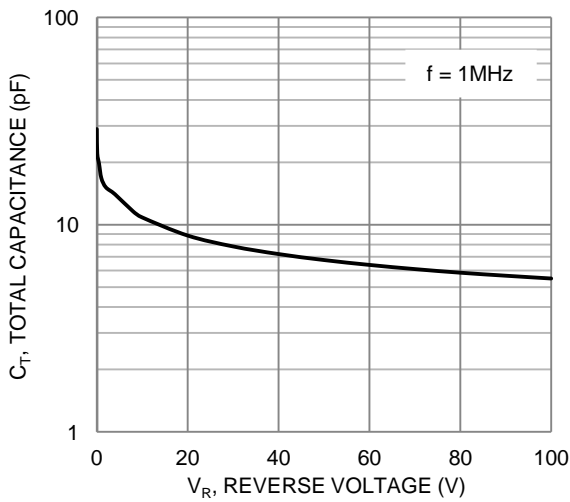
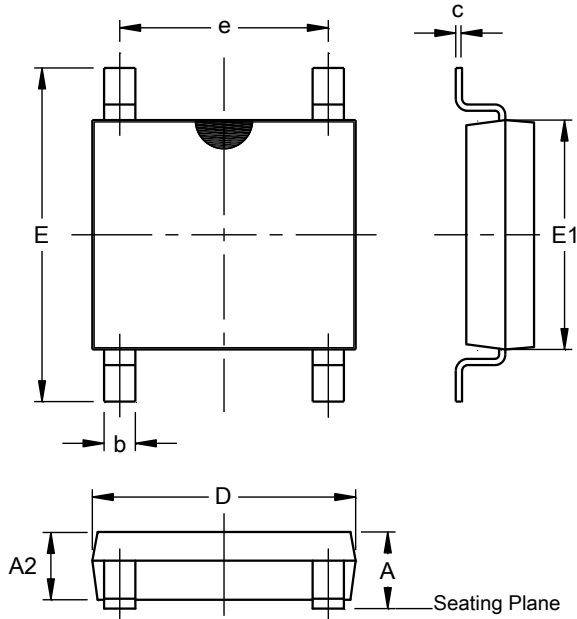

Figure 5. Typical Total Capacitance

**Package Outline Dimensions**

Please see <http://www.diodes.com/package-outlines.html> for the latest version.

**SOPA-4 (Type B)**



SOPA-4 (Type B)			
Dim	Min	Max	Typ
A	1.15	1.30	--
A2	1.00	1.25	--
b	0.50	0.70	--
c	0.15	0.25	--
D	4.80	5.30	--
E	6.00	6.80	--
E1	4.20	4.60	--
e	3.80	4.20	--
All Dimensions in mm			

**Suggested Pad Layout**

Please see <http://www.diodes.com/package-outlines.html> for the latest version.

**SOPA-4 (Type B)**

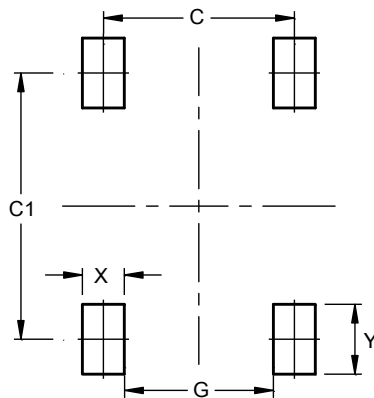

Dimensions	Value (in mm)
C	4.10
C1	5.72
G	3.20
X	0.90
Y	1.50

NEW PRODUCT

**IMPORTANT NOTICE**

DIODES INCORPORATED MAKES NO WARRANTY OF ANY KIND, EXPRESS OR IMPLIED, WITH REGARDS TO THIS DOCUMENT, INCLUDING, BUT NOT LIMITED TO, THE IMPLIED WARRANTIES OF MERCHANTABILITY AND FITNESS FOR A PARTICULAR PURPOSE (AND THEIR EQUIVALENTS UNDER THE LAWS OF ANY JURISDICTION).

Diodes Incorporated and its subsidiaries reserve the right to make modifications, enhancements, improvements, corrections or other changes without further notice to this document and any product described herein. Diodes Incorporated does not assume any liability arising out of the application or use of this document or any product described herein; neither does Diodes Incorporated convey any license under its patent or trademark rights, nor the rights of others. Any Customer or user of this document or products described herein in such applications shall assume all risks of such use and will agree to hold Diodes Incorporated and all the companies whose products are represented on Diodes Incorporated website, harmless against all damages.

Diodes Incorporated does not warrant or accept any liability whatsoever in respect of any products purchased through unauthorized sales channel. Should Customers purchase or use Diodes Incorporated products for any unintended or unauthorized application, Customers shall indemnify and hold Diodes Incorporated and its representatives harmless against all claims, damages, expenses, and attorney fees arising out of, directly or indirectly, any claim of personal injury or death associated with such unintended or unauthorized application.

Products described herein may be covered by one or more United States, international or foreign patents pending. Product names and markings noted herein may also be covered by one or more United States, international or foreign trademarks.

This document is written in English but may be translated into multiple languages for reference. Only the English version of this document is the final and determinative format released by Diodes Incorporated.

**LIFE SUPPORT**

Diodes Incorporated products are specifically not authorized for use as critical components in life support devices or systems without the express written approval of the Chief Executive Officer of Diodes Incorporated. As used herein:

A. Life support devices or systems are devices or systems which:

1. are intended to implant into the body, or
2. support or sustain life and whose failure to perform when properly used in accordance with instructions for use provided in the labeling can be reasonably expected to result in significant injury to the user.

B. A critical component is any component in a life support device or system whose failure to perform can be reasonably expected to cause the failure of the life support device or to affect its safety or effectiveness.

Customers represent that they have all necessary expertise in the safety and regulatory ramifications of their life support devices or systems, and acknowledge and agree that they are solely responsible for all legal, regulatory and safety-related requirements concerning their products and any use of Diodes Incorporated products in such safety-critical, life support devices or systems, notwithstanding any devices- or systems-related information or support that may be provided by Diodes Incorporated. Further, Customers must fully indemnify Diodes Incorporated and its representatives against any damages arising out of the use of Diodes Incorporated products in such safety-critical, life support devices or systems.

Copyright © 2018, Diodes Incorporated

[www.diodes.com](http://www.diodes.com)