

ZXMC3AM832

MPPS™ Miniature Package Power Solutions COMPLEMENTARY 30V ENHANCEMENT MODE MOSFET

SUMMARY

N-Channel $V_{(BR)DSS} = 30V$; $R_{DS(ON)} = 0.12\Omega$; $I_D = 3.7A$

P-Channel $V_{(BR)DSS} = -30V$; $R_{DS(ON)} = 0.21\Omega$; $I_D = -2.7A$

DESCRIPTION

Packaged in the new innovative 3mm x 2mm MLP(Micro Leaded Package) outline this dual 30V N channel Trench MOSFET utilizes a unique structure combining the benefits of Low on-resistance with fast switching speed. This makes them ideal for high efficiency, low voltage power management applications. Users will also gain several other key benefits:

Performance capability equivalent to much larger packages

Improved circuit efficiency & power levels

PCB area and device placement savings

Reduced component count

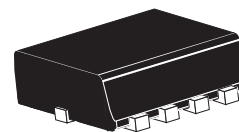

3mm x 2mm Dual Die MLP

FEATURES

- Low on - resistance
- Fast switching speed
- Low threshold
- Low gate drive
- 3mm x 2mm MLP

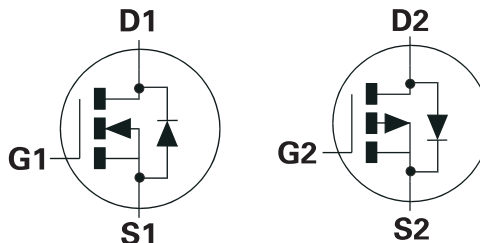

APPLICATIONS

- MOSFET gate drive
- LCD backlight inverters
- Motor control

ORDERING INFORMATION

DEVICE	REEL	TAPE WIDTH	QUANTITY PER REEL
ZXMC3AM832TA	7"	8mm	3000 units
ZXMC3AM832TC	13"	8mm	10000 units

DEVICE MARKING

C01

PINOUT

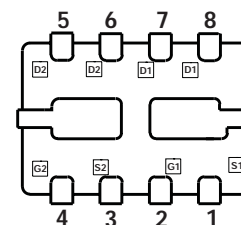

3 x 2 Dual MLP
underside view

ZXMC3AM832

ABSOLUTE MAXIMUM RATINGS

PARAMETER	SYMBOL	N-Channel	P-Channel	UNIT
Drain-Source Voltage	V_{DSS}	30	-30	V
Gate-Source Voltage	V_{GS}	± 20	± 20	V
Continuous Drain Current @ $V_{GS}=10V$; $T_A=25^\circ C$ ^{(b)(f)} @ $V_{GS}=10V$; $T_A=25^\circ C$ ^{(b)(f)} @ $V_{GS}=10V$; $T_A=25^\circ C$ ^{(a)(f)}	I_D	3.7	-2.7	A
		3.0	-2.2	A
		2.9	-2.1	A
Pulsed Drain Current	I_{DM}	12.4	-9.2	A
Continuous Source Current (Body Diode) ^{(b)(f)}	I_S	2.4	-2.8	A
Pulsed Source Current (Body Diode)	I_{SM}	12.4	-9.2	A
Power Dissipation at $T_A=25^\circ C$ ^{(a)(f)}	P_D	1.5		W
Linear Derating Factor		12		mW/ $^\circ C$
Power Dissipation at $T_A=25^\circ C$ ^{(b)(f)}	P_D	2.45		W
Linear Derating Factor		19.6		mW/ $^\circ C$
Power Dissipation at $T_A=25^\circ C$ ^{(c)(f)}	P_D	1		W
Linear Derating Factor		8		mW/ $^\circ C$
Power Dissipation at $T_A=25^\circ C$ ^{(d)(f)}	P_D	1.13		W
Linear Derating Factor		8		mW/ $^\circ C$
Power Dissipation at $T_A=25^\circ C$ ^{(d)(g)}	P_D	1.7		W
Linear Derating Factor		13.6		mW/ $^\circ C$

THERMAL RESISTANCE

PARAMETER	SYMBOL	VALUE	UNIT
Junction to Ambient ^{(a)(f)}	$R_{\theta JA}$	83.3	$^\circ C/W$
Junction to Ambient ^{(b)(f)}	$R_{\theta JA}$	51	$^\circ C/W$
Junction to Ambient ^{(c)(f)}	$R_{\theta JA}$	125	$^\circ C/W$
Junction to Ambient ^{(d)(f)}	$R_{\theta JA}$	111	$^\circ C/W$
Junction to Ambient ^{(d)(g)}	$R_{\theta JA}$	73.5	$^\circ C/W$
Junction to Ambient ^{(e)(g)}	$R_{\theta JA}$	41.7	$^\circ C/W$

Notes

- (a) For a dual device surface mounted on 8 sq cm single sided 2oz copper on FR4 PCB, in still air conditions **with all exposed pads attached**. The copper are is split down the centre line into two separate areas with one half connected to each half of the dual device.
- (b) Measured at $t < 5$ secs for a dual device surface mounted on 8 sq cm single sided 2oz copper on FR4 PCB, in still air conditions **with all exposed pads attached**. The copper are is split down the centre line into two separate areas with one half connected to each half of the dual device.
- (c) For a dual device surface mounted on 8 sq cm single sided 2oz copper on FR4 PCB, in still air conditions **with minimal lead connections only**.
- (d) For a dual device surface mounted on 10 sq cm single sided 1oz copper on FR4 PCB, in still air conditions **with all exposed pads attached attached**. The copper are is split down the centre line into two separate areas with one half connected to each half of the dual device.
- (e) For a dual device surface mounted on 85 sq cm single sided 2oz copper on FR4 PCB, in still air conditions **with all exposed pads attached attached**. The copper are is split down the centre line into two separate areas with one half connected to each half of the dual device.
- (f) For a dual device with one active die.
- (g) For dual device with 2 active die running at equal power.
- (h) Repetitive rating - pulse width limited by max junction temperature. Refer to Transient Thermal Impedance graph.
- (i) The minimum copper dimensions required for mounting are no smaller than the exposed metal pads on the base if the device as shown in the package dimensions data. The thermal resistance for a dual device mounted on 1.5mm thick FR4 board using minimum copper 1 oz weight, 1mm wide tracks and one half of the device active is $R_{th} = 250^\circ C/W$ giving a power rating of $P_{tot} = 500mW$.

ZXMC3AM832

TYPICAL CHARACTERISTICS

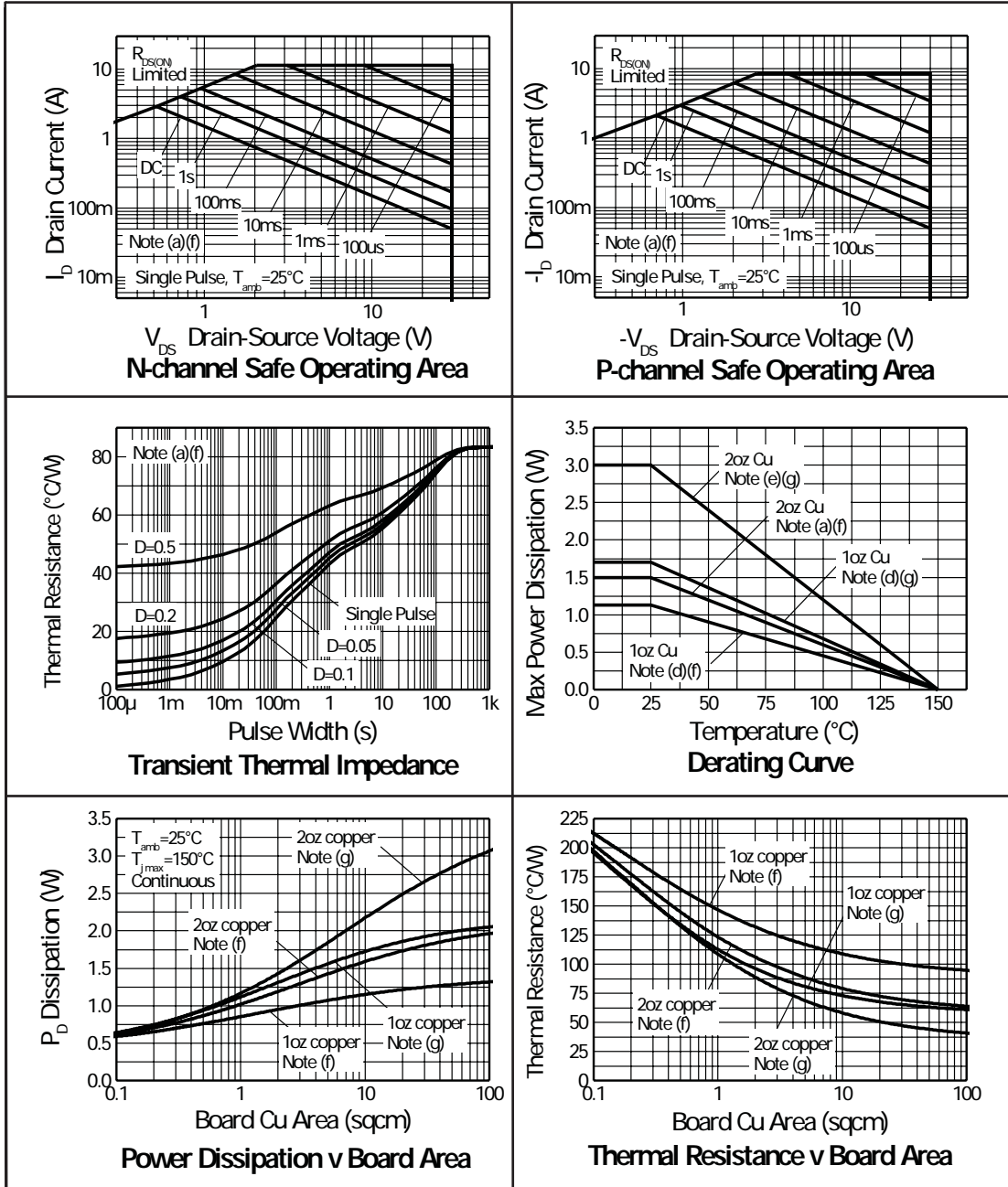

ZXMC3AM832

N-CHANNEL

ELECTRICAL CHARACTERISTICS (at $T_{amb} = 25^{\circ}\text{C}$ unless otherwise stated)

PARAMETER	SYMBOL	MIN.	TYP.	MAX.	UNIT	CONDITIONS
STATIC						
Drain-Source Breakdown Voltage	$V_{(BR)DSS}$	30			V	$I_D=250\mu\text{A}, V_{GS}=0\text{V}$
Zero Gate Voltage Drain Current	I_{DSS}			0.5	μA	$V_{DS}=30\text{V}, V_{GS}=0\text{V}$
Gate-Body Leakage	I_{GSS}			100	nA	$V_{GS}=\pm 20\text{V}, V_{DS}=0\text{V}$
Gate-Source Threshold Voltage	$V_{GS(th)}$	1			V	$I_D=250\mu\text{A}, V_{DS}=V_{GS}$
Static Drain-Source On-State Resistance ⁽¹⁾	$R_{DS(on)}$		0.106	0.12 0.18	Ω Ω	$V_{GS}=10\text{V}, I_D=2.5\text{A}$ $V_{GS}=4.5\text{V}, I_D=2.0\text{A}$
Forward Transconductance ⁽¹⁾⁽³⁾	g_{fs}		3.5		S	$V_{DS}=4.5\text{V}, I_D=2.5\text{A}$
DYNAMIC ⁽³⁾						
Input Capacitance	C_{iss}		190		pF	$V_{DS}=25\text{V}, V_{GS}=0\text{V},$ $f=1\text{MHz}$
Output Capacitance	C_{oss}		38		pF	
Reverse Transfer Capacitance	C_{rss}		20		pF	
SWITCHING ^{(2) (3)}						
Turn-On Delay Time	$t_{d(on)}$		1.7		ns	$V_{DD}=15\text{V}, I_D=2.5\text{A}$ $R_G=6.0\Omega, V_{GS}=10\text{V}$
Rise Time	t_r		2.3		ns	
Turn-Off Delay Time	$t_{d(off)}$		6.6		ns	
Fall Time	t_f		2.9		ns	
Gate Charge	Q_g		2.3		nC	$V_{DS}=15\text{V}, V_{GS}=5\text{V},$ $I_D=2.5\text{A}$
Total Gate Charge	Q_g		3.9		nC	$V_{DS}=15\text{V}, V_{GS}=10\text{V},$ $I_D=2.5\text{A}$
Gate-Source Charge	Q_{gs}		0.6		nC	
Gate-Drain Charge	Q_{gd}		0.9		nC	
SOURCE-DRAIN DIODE						
Diode Forward Voltage ⁽¹⁾	V_{SD}		0.85	0.95	V	$T_J=25^{\circ}\text{C}, I_S=1.7\text{A},$ $V_{GS}=0\text{V}$
Reverse Recovery Time ⁽³⁾	t_{rr}		17.7		ns	$T_J=25^{\circ}\text{C}, I_F=2.5\text{A},$ $di/dt=100\text{A}/\mu\text{s}$
Reverse Recovery Charge ⁽³⁾	Q_{rr}		13.0		nC	

NOTES

- (1) Measured under pulsed conditions. Width $\leq 300\mu\text{s}$. Duty cycle $\leq 2\%$.
 (2) Switching characteristics are independent of operating junction temperature.
 (3) For design aid only, not subject to production testing.

ZXMC3AM832

P-CHANNEL ELECTRICAL CHARACTERISTICS (at $T_{amb} = 25^{\circ}\text{C}$ unless otherwise stated)

PARAMETER	SYMBOL	MIN.	TYP.	MAX.	UNIT	CONDITIONS
STATIC						
Drain-Source Breakdown Voltage	$V_{(BR)DSS}$	-30			V	$I_D = -250\mu\text{A}$, $V_{GS} = 0\text{V}$
Zero Gate Voltage Drain Current	I_{DSS}			1	μA	$V_{DS} = -30\text{V}$, $V_{GS} = 0\text{V}$
Gate-Body Leakage	I_{GSS}			100	nA	$V_{GS} = \pm 20\text{V}$, $V_{DS} = 0\text{V}$
Gate-Source Threshold Voltage	$V_{GS(th)}$	-0.8			V	$I_D = -250\mu\text{A}$, $V_{DS} = V_{GS}$
Static Drain-Source On-State Resistance ⁽¹⁾	$R_{DS(on)}$			0.210 0.330	Ω Ω	$V_{GS} = -10\text{V}$, $I_D = -1.4\text{A}$ $V_{GS} = -4.5\text{V}$, $I_D = -1.1\text{A}$
Forward Transconductance ⁽¹⁾⁽³⁾	g_{fs}		2.48		S	$V_{DS} = -15\text{V}$, $I_D = -1.4\text{A}$
DYNAMIC ⁽³⁾						
Input Capacitance	C_{iss}		204		pF	$V_{DS} = -15\text{V}$, $V_{GS} = 0\text{V}$, $f = 1\text{MHz}$
Output Capacitance	C_{oss}		39.8		pF	
Reverse Transfer Capacitance	C_{rss}		25.8		pF	
SWITCHING ^{(2) (3)}						
Turn-On Delay Time	$t_{d(on)}$		1.5		ns	$V_{DD} = -15\text{V}$, $I_D = -1\text{A}$ $R_G = 6.0\Omega$, $V_{GS} = -10\text{V}$
Rise Time	t_r		2.8		ns	
Turn-Off Delay Time	$t_{d(off)}$		11.3		ns	
Fall Time	t_f		7.5		ns	
Gate Charge	Q_g		2.58		nC	$V_{DS} = -15\text{V}$, $V_{GS} = -5\text{V}$, $I_D = -1.4\text{A}$
Total Gate Charge	Q_g		5.15		nC	$V_{DS} = -15\text{V}$, $V_{GS} = -10\text{V}$, $I_D = -1.4\text{A}$
Gate-Source Charge	Q_{gs}		0.65		nC	
Gate-Drain Charge	Q_{gd}		0.92		nC	
SOURCE-DRAIN DIODE						
Diode Forward Voltage ⁽¹⁾	V_{SD}		-0.85	-0.95	V	$T_J = 25^{\circ}\text{C}$, $I_S = -1.1\text{A}$, $V_{GS} = 0\text{V}$
Reverse Recovery Time ⁽³⁾	t_{rr}		18.6		ns	$T_J = 25^{\circ}\text{C}$, $I_F = -0.95\text{A}$, $di/dt = 100\text{A}/\mu\text{s}$
Reverse Recovery Charge ⁽³⁾	Q_{rr}		14.8		nC	

NOTES

- (1) Measured under pulsed conditions. Width $\leq 300\mu\text{s}$. Duty cycle $\leq 2\%$.
 (2) Switching characteristics are independent of operating junction temperature.
 (3) For design aid only, not subject to production testing.

ZXMC3AM832

N-CHANNEL TYPICAL CHARACTERISTICS

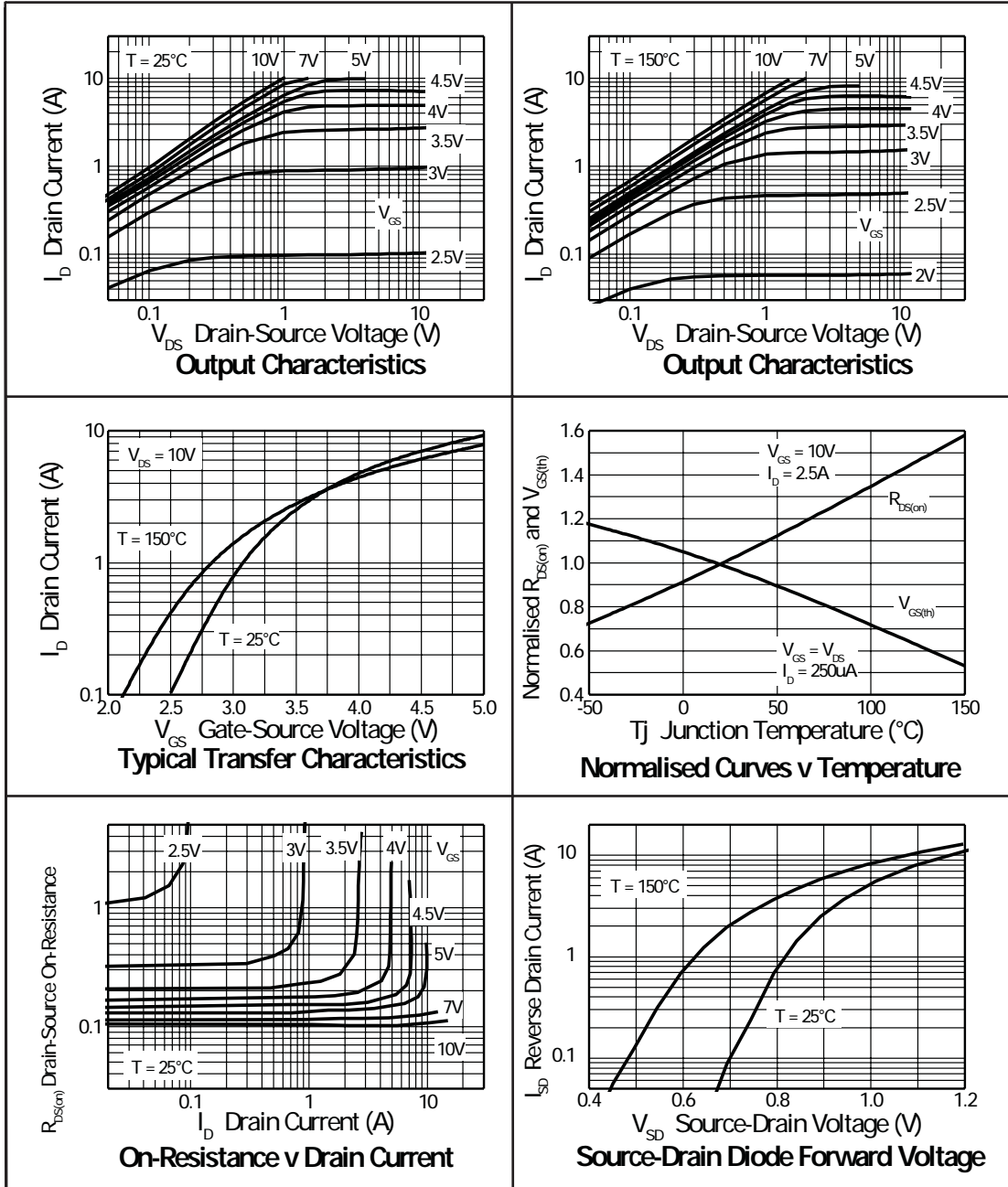

ZXMC3AM832

N-CHANNEL TYPICAL CHARACTERISTICS

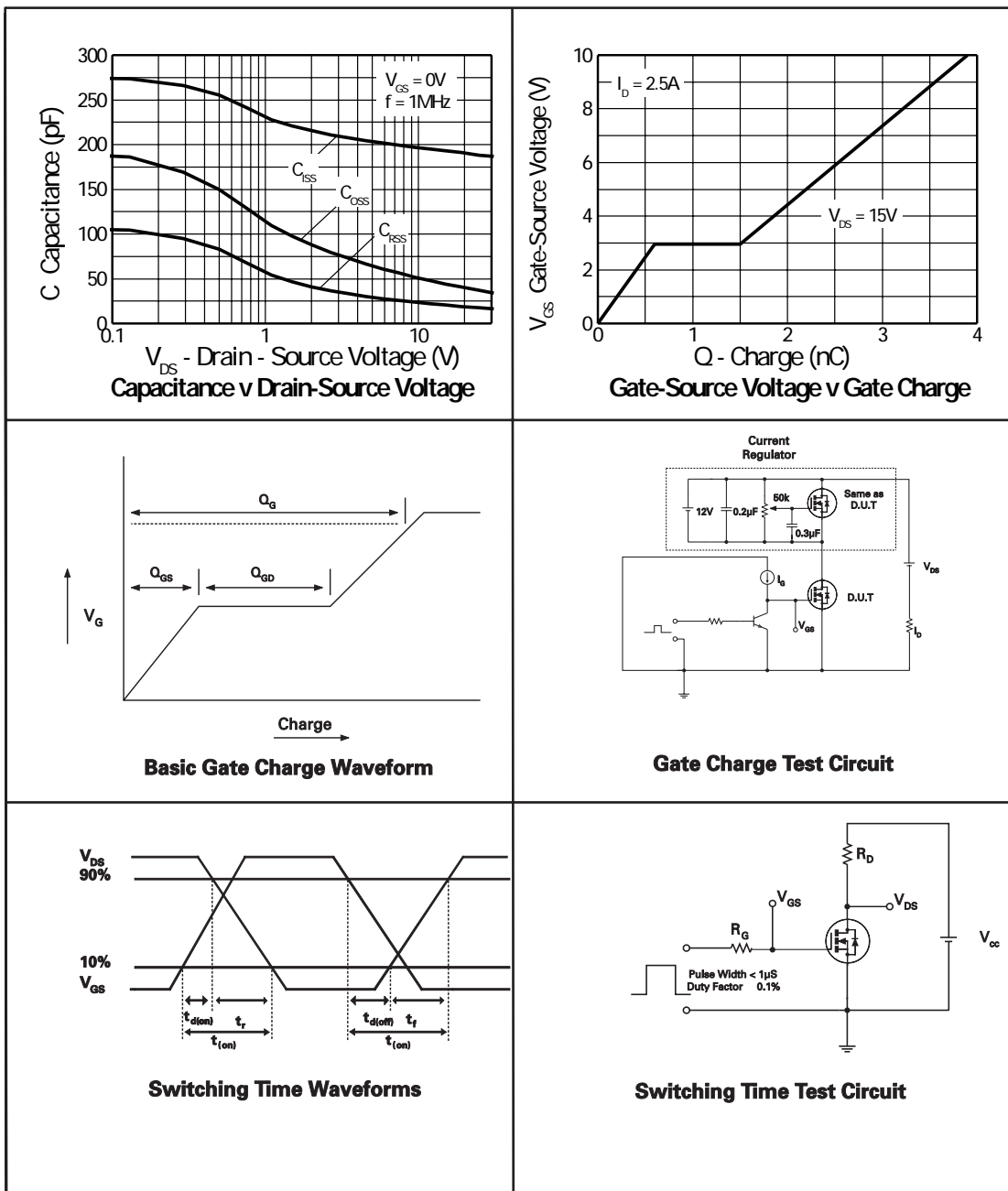

ZXMC3AM832

P-CHANNEL TYPICAL CHARACTERISTICS

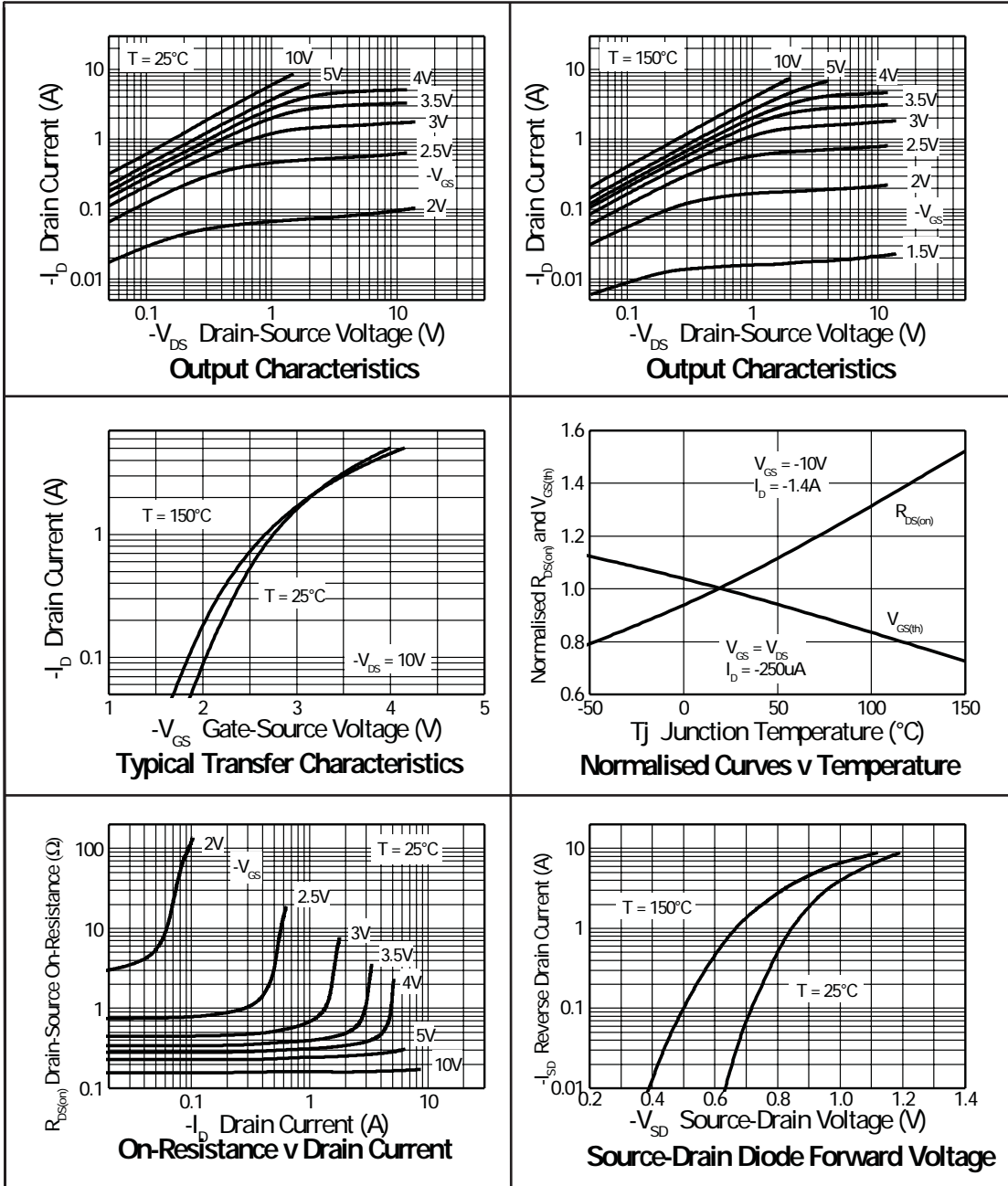

ZXMC3AM832

P-CHANNEL TYPICAL CHARACTERISTICS

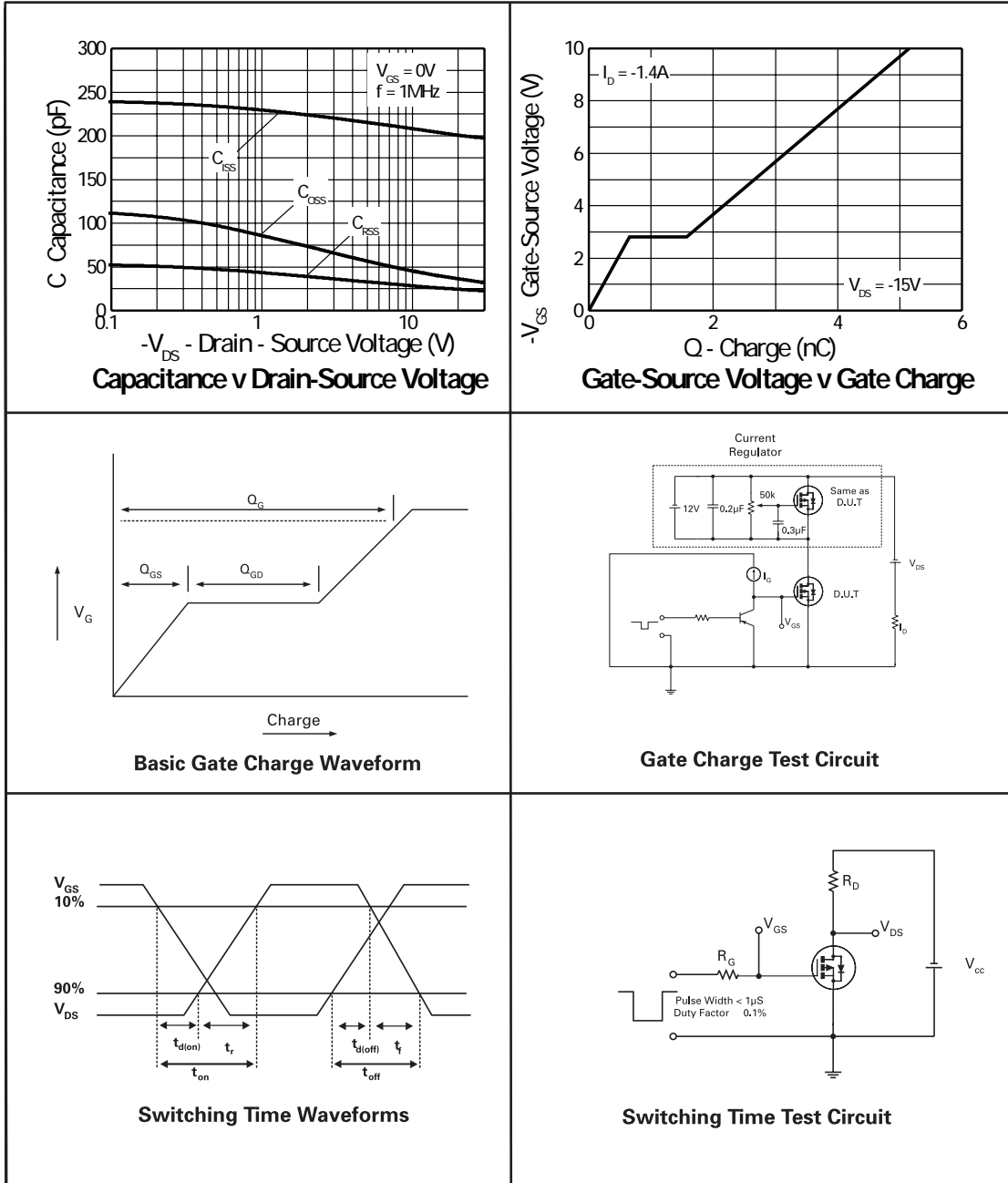

ZXMC3AM832

MLP832 PACKAGE OUTLINE (3mm x 2mm Micro Leaded Package)

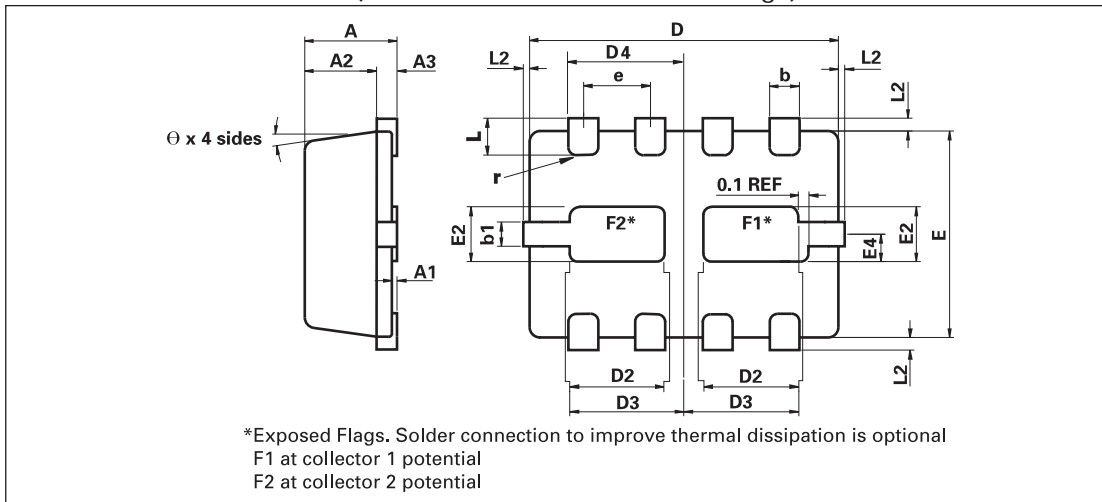

CONTROLLING DIMENSIONS IN MILLIMETERS APPROX. CONVERTED DIMENSIONS IN INCHES

PACKAGE DIMENSIONS

DIM	Millimeters		Inches		DIM	Millimeters		Inches	
	Min	Max	Min	Max		Min	Max	Min	Max
A	0.80	1.00	0.0315	0.0394	e	0.65 BSC		0.0256 BSC	
A1	0.00	0.05	0.00	0.002	E	2.00 BSC		0.0787 BSC	
A2	0.65	0.75	0.0256	0.0295	E2	0.43	0.63	0.017	0.0248
A3	0.15	0.25	0.006	0.0098	L	0.20	0.45	0.0079	0.0177
b	0.24	0.34	0.0095	0.0134	L2	0.00	0.125	0.00	0.005
b1	0.17	0.30	0.0068	0.0118	r	0.075 BSC		0.0029 BSC	
D	3.00 BSC		0.118 BSC		Theta	0°	12°	0°	12°
D2	0.82	1.02	0.0323	0.0402	-	-	-	-	-
D3	1.01	1.21	0.0398	0.0476	-	-	-	-	-

© Zetex Semiconductors plc 2004

Europe	Americas	Asia Pacific	Corporate Headquarters
Zetex GmbH Streitfeldstraße 19 D-81673 München Germany	Zetex Inc 700 Veterans Memorial Hwy Hauppauge, NY 11788 USA	Zetex (Asia) Ltd 3701-04 Metroplaza Tower 1 Hing Fong Road, Kwai Fong Hong Kong	Zetex Semiconductors plc Lansdowne Road, Chadderton Oldham, OL9 9TY United Kingdom
Telefon: (49) 89 45 49 49 0 Fax: (49) 89 45 49 49 49 europa.sales@zetex.com	Telephone: (1) 631 360 2222 Fax: (1) 631 360 8222 usa.sales@zetex.com	Telephone: (852) 26100 611 Fax: (852) 24250 494 asia.sales@zetex.com	Telephone (44) 161 622 4444 Fax: (44) 161 622 4446 hq@zetex.com

These offices are supported by agents and distributors in major countries world-wide.

This publication is issued to provide outline information only which (unless agreed by the Company in writing) may not be used, applied or reproduced for any purpose or form part of any order or contract or be regarded as a representation relating to the products or services concerned. The Company reserves the right to alter without notice the specification, design, price or conditions of supply of any product or service.

For the latest product information, log on to www.zetex.com



PROVISIONAL ISSUE E - JULY 2004