

## COMPLEMENTARY PAIR ENHANCEMENT MODE FIELD EFFECT TRANSISTOR

NEW PRODUCT

### Features

- Low On-Resistance:  $R_{DS(ON)}$
- Low Gate Threshold Voltage
- Low Input Capacitance
- Fast Switching Speed
- Low Input/Output Leakage
- Complementary Pair
- Also Available in Lead Free Version

### Mechanical Data

- Case: SOT-363, Molded Plastic
- Case material - UL Flammability Rating Classification 94V-0
- Moisture sensitivity: Level 1 per J-STD-020A
- Terminals: Solderable per MIL-STD-202, Method 208
- Also Available in Lead Free Plating (Matte Tin Finish). Please see Ordering Information, Note 4, on Page 5
- Terminal Connections: See Diagram
- Marking: KNP (See Page 5)
- Weight: 0.008 grams (approx.)

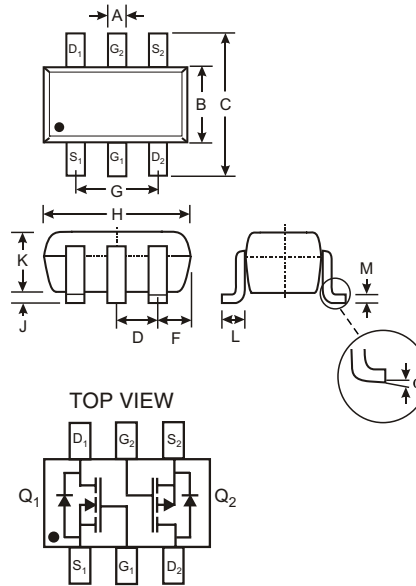

SOT-363		
Dim	Min	Max
A	0.10	0.30
B	1.15	1.35
C	2.00	2.20
D	0.65 Nominal	
F	0.30	0.40
H	1.80	2.20
J	—	0.10
K	0.90	1.00
L	0.25	0.40
M	0.10	0.25
$\alpha$	0°	8°
All Dimensions in mm		

### Maximum Ratings - Total Device @ $T_A = 25^\circ\text{C}$ unless otherwise specified

Characteristic	Symbol	Value	Units
Power Dissipation (Note 1)	$P_d$	200	mW
Thermal Resistance, Junction to Ambient	$R_{\theta JA}$	625	$^\circ\text{C}/\text{W}$
Operating and Storage Temperature Range	$T_j, T_{STG}$	-55 to +150	$^\circ\text{C}$

### Maximum Ratings N-CHANNEL - $Q_1$ , 2N7002 Section @ $T_A = 25^\circ\text{C}$ unless otherwise specified

Characteristic	Symbol	Value	Units
Drain-Source Voltage	$V_{DSS}$	60	V
Drain-Gate Voltage $R_{GS} \leq 1.0\text{M}\Omega$	$V_{DGR}$	60	V
Gate-Source Voltage	$V_{GSS}$	$\pm 20$ $\pm 40$	V
Drain Current (Note 1)	$I_D$	115 73 800	mA
		Continuous Continuous @ $100^\circ\text{C}$ Pulsed	

### Maximum Ratings P-CHANNEL - $Q_2$ , BSS84 Section @ $T_A = 25^\circ\text{C}$ unless otherwise specified

Characteristic	Symbol	Value	Units
Drain-Source Voltage	$V_{DSS}$	-50	V
Drain-Gate Voltage $R_{GS} \leq 20\text{K}\Omega$	$V_{DGR}$	-50	V
Gate-Source Voltage	$V_{GSS}$	$\pm 20$	V
Drain Current (Note 1)	$I_D$	-130	mA
		Continuous	

Note: 1. Device mounted on FR-4 PCB, 1 inch x 0.85 inch x 0.062 inch; pad layout as shown on Diodes Inc. suggested pad layout document AP02001, which can be found on our website at <http://www.diodes.com/datasheets/ap02001.pdf>.

**Electrical Characteristics N-CHANNEL - Q<sub>1</sub>, 2N7002 Section** @ T<sub>A</sub> = 25°C unless otherwise specified

Characteristic	Symbol	Min	Typ	Max	Unit	Test Condition
<b>OFF CHARACTERISTICS (Note 2)</b>						
Drain-Source Breakdown Voltage	BV <sub>DSS</sub>	60	70	—	V	V <sub>GS</sub> = 0V, I <sub>D</sub> = 10μA
Zero Gate Voltage Drain Current	I <sub>DSS</sub>	—	—	1.0 500	μA	V <sub>DS</sub> = 60V, V <sub>GS</sub> = 0V @ T <sub>C</sub> = 25°C @ T <sub>C</sub> = 125°C
Gate-Body Leakage	I <sub>GSS</sub>	—	—	±10	nA	V <sub>GS</sub> = ±20V, V <sub>DS</sub> = 0V
<b>ON CHARACTERISTICS (Note 2)</b>						
Gate Threshold Voltage	V <sub>GS(th)</sub>	1.0	—	2.5	V	V <sub>DS</sub> = V <sub>GS</sub> , I <sub>D</sub> = 250μA
Static Drain-Source On-Resistance	R <sub>DS(ON)</sub>	—	3.2 4.4	7.5 13.5	Ω	V <sub>GS</sub> = 5.0V, I <sub>D</sub> = 0.05A @ T <sub>J</sub> = 25°C @ T <sub>J</sub> = 125°C
On-State Drain Current	I <sub>D(ON)</sub>	0.5	1.0	—	A	V <sub>GS</sub> = 10V, V <sub>DS</sub> = 7.5V
Forward Transconductance	g <sub>FS</sub>	80	—	—	mS	V <sub>DS</sub> = 10V, I <sub>D</sub> = 0.2A
<b>DYNAMIC CHARACTERISTICS</b>						
Input Capacitance	C <sub>iss</sub>	—	22	50	pF	V <sub>DS</sub> = 25V, V <sub>GS</sub> = 0V f = 1.0MHz
Output Capacitance	C <sub>oss</sub>	—	11	25	pF	
Reverse Transfer Capacitance	C <sub>rss</sub>	—	2.0	5.0	pF	
<b>SWITCHING CHARACTERISTICS</b>						
Turn-On Delay Time	t <sub>D(ON)</sub>	—	7.0	20	ns	V <sub>DD</sub> = 30V, I <sub>D</sub> = 0.2A, R <sub>L</sub> = 150Ω, V <sub>GEN</sub> = 10V, R <sub>GEN</sub> = 25Ω
Turn-Off Delay Time	t <sub>D(OFF)</sub>	—	11	20	ns	

**Electrical Characteristics P-CHANNEL - Q<sub>2</sub>, BSS84 Section** @ T<sub>A</sub> = 25°C unless otherwise specified

Characteristic	Symbol	Min	Typ	Max	Unit	Test Condition
<b>OFF CHARACTERISTICS (Note 2)</b>						
Drain-Source Breakdown Voltage	BV <sub>DSS</sub>	-50	—	—	V	V <sub>GS</sub> = 0V, I <sub>D</sub> = -250μA
Zero Gate Voltage Drain Current	I <sub>DSS</sub>	—	—	-15 -60 -100	μA μA nA	V <sub>DS</sub> = -50V, V <sub>GS</sub> = 0V, T <sub>J</sub> = 25°C V <sub>DS</sub> = -50V, V <sub>GS</sub> = 0V, T <sub>J</sub> = 125°C V <sub>DS</sub> = -25V, V <sub>GS</sub> = 0V, T <sub>J</sub> = 25°C
Gate-Body Leakage	I <sub>GSS</sub>	—	—	±10	nA	V <sub>GS</sub> = ±20V, V <sub>DS</sub> = 0V
<b>ON CHARACTERISTICS (Note 2)</b>						
Gate Threshold Voltage	V <sub>GS(th)</sub>	-0.8	—	-2.0	V	V <sub>DS</sub> = V <sub>GS</sub> , I <sub>D</sub> = -1mA
Static Drain-Source On-Resistance	R <sub>DS(ON)</sub>	—	—	10	Ω	V <sub>GS</sub> = -5V, I <sub>D</sub> = -0.100A
Forward Transconductance	g <sub>FS</sub>	.05	—	—	S	V <sub>DS</sub> = -25V, I <sub>D</sub> = -0.1A
<b>DYNAMIC CHARACTERISTICS</b>						
Input Capacitance	C <sub>iss</sub>	—	—	45	pF	V <sub>DS</sub> = -25V, V <sub>GS</sub> = 0V f = 1.0MHz
Output Capacitance	C <sub>oss</sub>	—	—	25	pF	
Reverse Transfer Capacitance	C <sub>rss</sub>	—	—	12	pF	
<b>SWITCHING CHARACTERISTICS</b>						
Turn-On Delay Time	t <sub>D(ON)</sub>	—	10	—	ns	V <sub>DD</sub> = -30V, I <sub>D</sub> = -0.27A, R <sub>GEN</sub> = 50Ω, V <sub>GS</sub> = -10V
Turn-Off Delay Time	t <sub>D(OFF)</sub>	—	18	—	ns	

Note: 2. Short duration test pulse used to minimize self-heating effect.

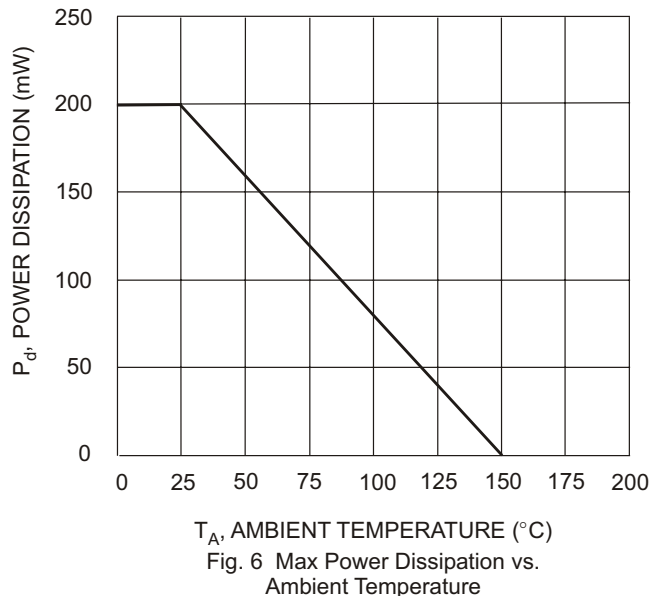
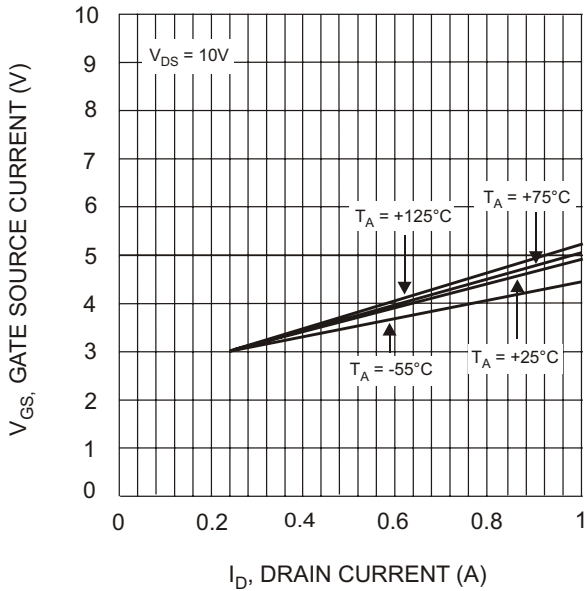
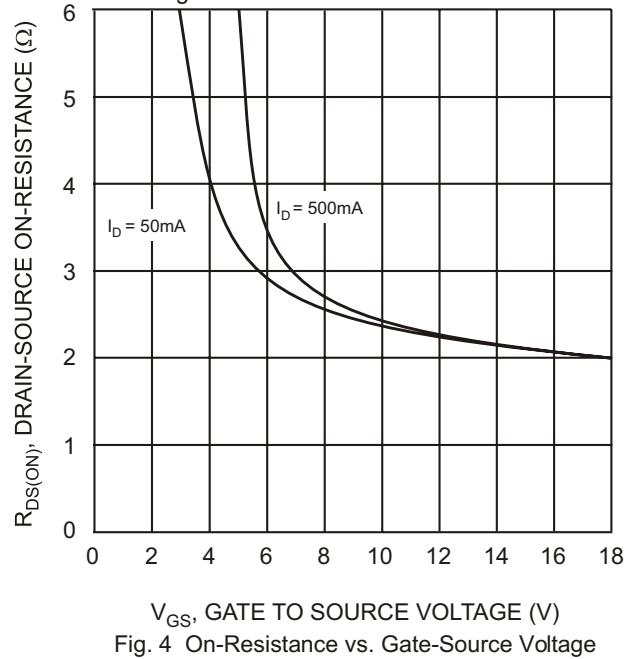
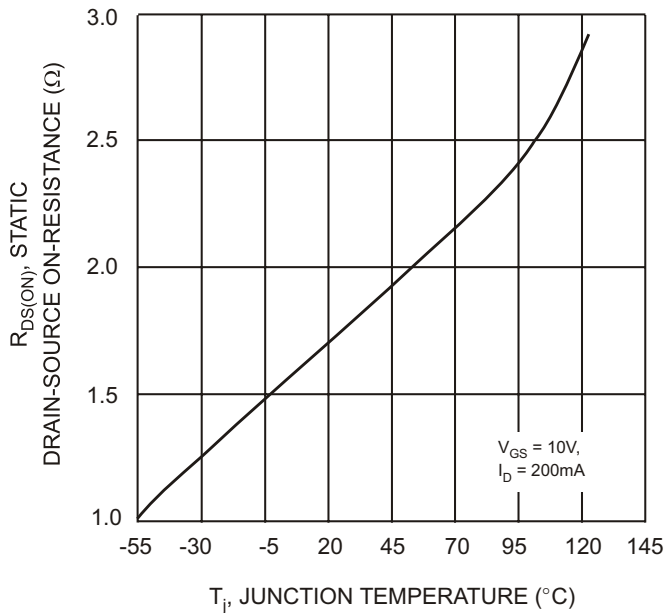
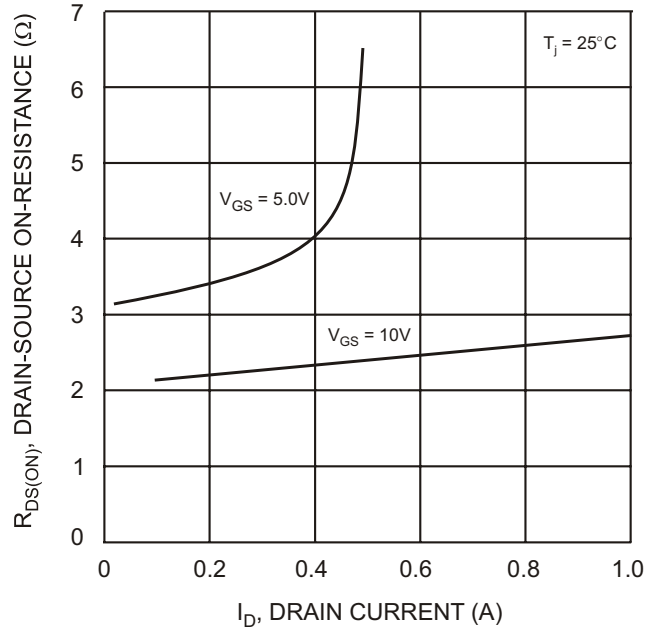
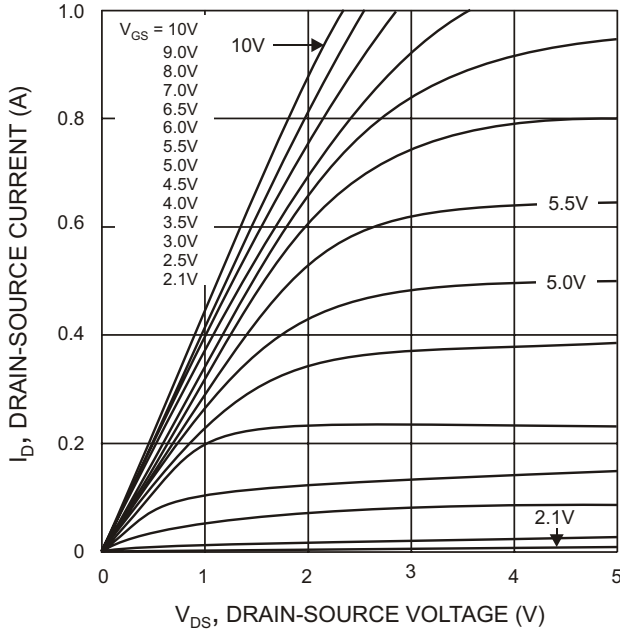

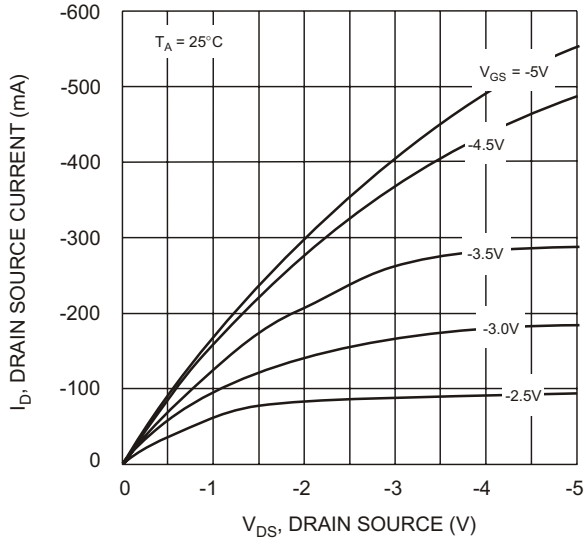

Fig. 7, Drain Source Current vs. Drain Source Voltage

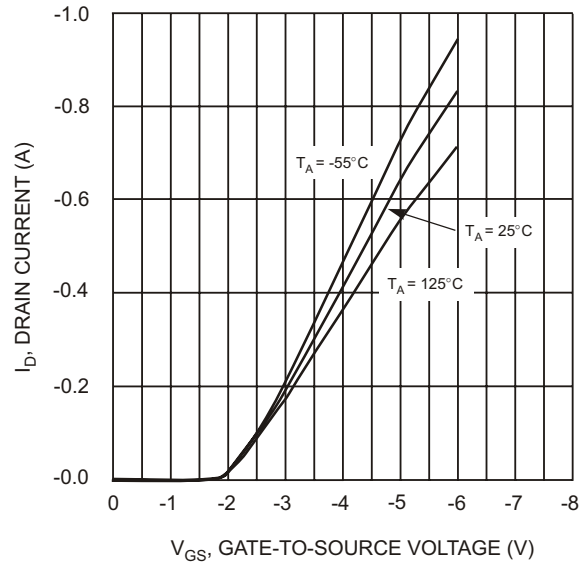

Fig. 8, Drain Current vs. Gate Source Voltage

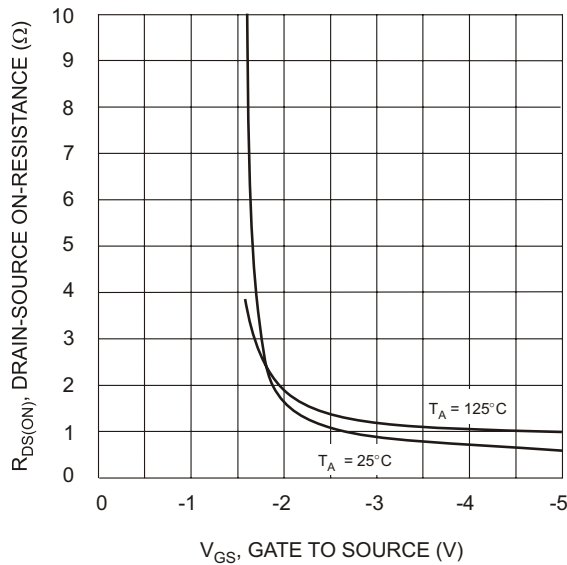

Fig. 9, On Resistance vs. Gate Source Voltage

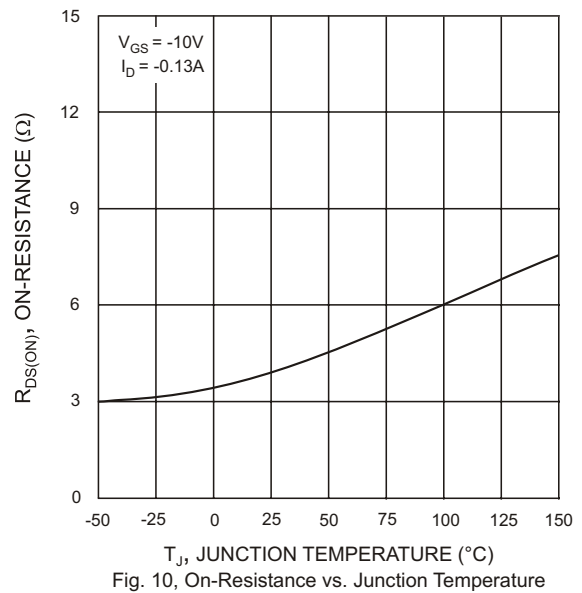

Fig. 10, On-Resistance vs. Junction Temperature

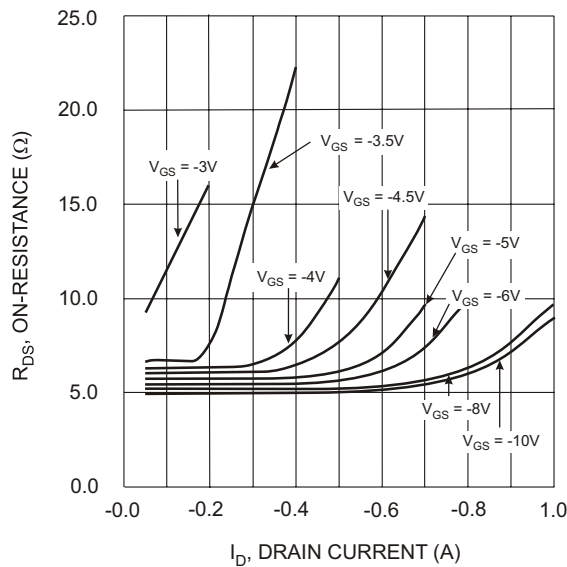

Fig. 11, On-Resistance vs. Drain Current

**Ordering Information** (Note 3)

Device	Packaging	Shipping
BSS8402DW-7	SOT-363	3000/Tape & Reel

- Notes:
- For Packaging Details, go to our website at <http://www.diodes.com/datasheets/ap02007.pdf>.
  - For Lead Free version (with Lead Free terminal finish) part number, please add "-F" suffix to part number above.  
Example: BSS8402DW-7-F.

**Marking Information**

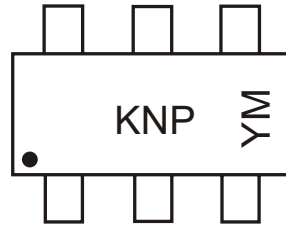

KNP = Product Type Marking Code  
 YM = Date Code Marking  
 Y = Year ex: R = 2004  
 M = Month ex: 9 = September

Date Code Key

Year	2003	2004	2005	2006	2007	2008	2009
Code	P	R	S	T	U	V	W

Month	Jan	Feb	March	Apr	May	Jun	Jul	Aug	Sep	Oct	Nov	Dec
Code	1	2	3	4	5	6	7	8	9	O	N	D