

## Features

- ESD Protection >30kV (Human Body Model) (Note 1)
- Ultra-Small Surface Mount Package
- Protects 2 Data Lines
- Low Leakage <25nA
- Low Capacitance 3pF Typ.
- Protects USB 2.0 and USB 1.1
- **Lead, Halogen and Antimony Free, RoHS Compliant "Green" Device (Notes 2, 3 and 4)**

## EC Compatibility (Note 1)

- 61000-4-2 (ESD) Air-30kV Contact-30kV
- 61000-4-4 (EFT) 40A, 5/50 ns
- 61000-4-5 (Surge) 8x20µs, 20 Amperes

## Mechanical Data

- Case: SOT-363
- Case Material: Molded Plastic. UL Flammability Classification Rating 94V-0
- Moisture Sensitivity: Level 1 per J-STD-020
- Terminals: Finish — Matte Tin annealed over Alloy 42 leadframe. Solderable per MIL-STD-202, Method 208
- Orientation: See Diagram Below
- Weight: 0.006 grams (approximate)

SOT-363



Top View

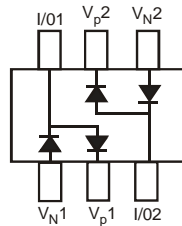

Internal Schematic

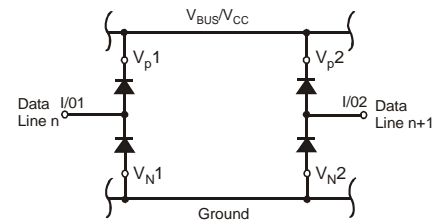

APPLICATION

Top View

## Ordering Information (Note 5)

Part Number	Case	Packaging
SDA004-7	SOT-363	3000/Tape & Reel

- Notes:
1. Tested with  $V_P$  connected to  $V_N$  to simulate appropriate  $V_{BUS}/V_{CC}$  decoupling to ground.
  2. No purposefully added lead. Halogen and Antimony Free.
  3. Diodes Inc.'s "Green" policy can be found on our website at <http://www.diodes.com>.
  4. Product manufactured with Data Code V9 (week 33, 2008) and newer are built with Green Molding Compound. Product manufactured prior to Date Code V9 are built with Non-Green Molding Compound and may contain Halogens or  $Sb_2O_3$  Fire Retardants.
  5. For packaging details, go to our website at <http://www.diodes.com>.

## Marking Information

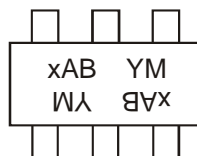

KAB or JAB = Product Type Marking Code  
 YM = Date Code Marking  
 Y = Year ex: R = 2004  
 M = Month ex: 9 = September

### Date Code Key

Year	2004	2005	2006	2007	2008	2009	2010	2111	2012	2013	2014	2015
Code	R	S	T	U	V	W	X	Y	Z	A	B	C
Month	Jan	Feb	Mar	Apr	May	Jun	Jul	Aug	Sep	Oct	Nov	Dec
Code	1	2	3	4	5	6	7	8	9	O	N	D

### Maximum Ratings @T<sub>A</sub> = 25°C unless otherwise specified

Characteristic	Symbol	Value	Unit
Non-Repetitive Peak Reverse Voltage	V <sub>RM</sub>	100	V
Peak Repetitive Reverse Voltage	V <sub>RPM</sub>	80	V
Working Peak Reverse Voltage	V <sub>RWM</sub>		
DC Blocking Voltage	V <sub>R</sub>		
Forward Continuous Current (Note 6)	I <sub>FM</sub>	500	mA
Repetitive Peak Forward Current @ T <sub>p</sub> = 5μs, f = 50kHz (Note 6)	I <sub>FRM</sub>	1000	mA
Non-Repetitive Peak Forward Surge Current	I <sub>FSM</sub>	20	A
@ t = 1.0μs		1.0	
Clamping Voltage @ I <sub>pp</sub> = 20A (Note 7) 8x20μs Waveform	V <sub>C</sub>	16	V

### Thermal Characteristics

Characteristic	Symbol	Value	Unit
Power Dissipation (Note 6)	P <sub>D</sub>	200	mW
Thermal Resistance, Junction to Ambient Air (Note 6)	R <sub>θJA</sub>	625	°C/W
Operating and Storage Temperature Range	T <sub>J</sub> , T <sub>STG</sub>	-65 to +150	°C

### Electrical Characteristics @T<sub>A</sub> = 25°C unless otherwise specified

Characteristic	Symbol	Min	Typ	Max	Unit	Test Condition
Reverse Breakdown Voltage (Note 8)	V <sub>(BR)R</sub>	80	—	—	V	I <sub>R</sub> = 100μA
Forward Voltage	V <sub>F</sub>	0.62	—	0.72	V	I <sub>F</sub> = 5.0mA
		—		0.93		I <sub>F</sub> = 20mA
		—		1.0		I <sub>F</sub> = 100mA
		—		1.25		I <sub>F</sub> = 150mA
Reverse Current (Note 8)	I <sub>R</sub>	—	—	100	nA	V <sub>R</sub> = 70V
				50	μA	V <sub>R</sub> = 75V, T <sub>J</sub> = 150°C
				30	μA	V <sub>R</sub> = 25V, T <sub>J</sub> = 150°C
				25	nA	V <sub>R</sub> = 20V
Capacitance, Between I/O Lines (I/O1 & I/O2)	C <sub>LL</sub>	—	2.5	4.0	pF	V <sub>R</sub> = 0V, f = 1.0MHz
Capacitance Between I/O Line and Ground	C <sub>LG</sub>	—	3.3	5.3	pF	V <sub>R</sub> = 0V, f = 1.0MHz
Reverse Recovery Time	t <sub>rr</sub>	—	—	4.0	ns	V <sub>R</sub> = 6V, I <sub>F</sub> = 5mA

- Notes:
6. Device mounted on FR-4 PCB, 1 inch x 0.85 inch x 0.062 inch; pad layout as shown on Diodes Inc. suggested pad layout document AP02001, which can be found on our website at <http://www.diodes.com>.
  7. Referenced to V<sub>P</sub> or V<sub>N</sub>.
  8. Short duration pulse test used to minimize self-heating effect.

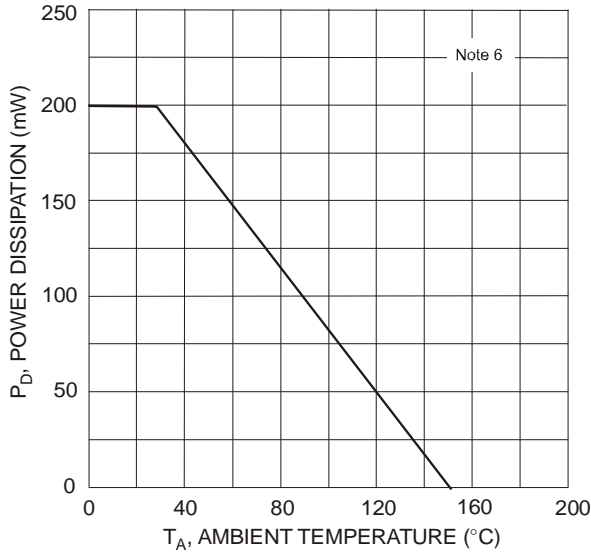

Fig. 1 Power Derating Curve, Total Package

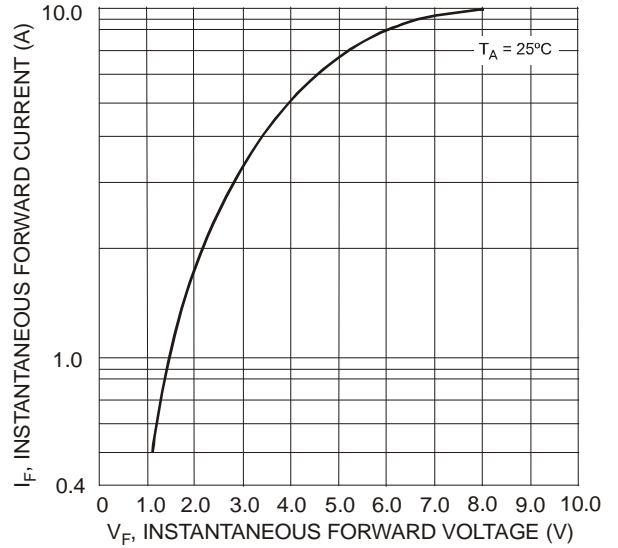

Fig. 2 Typical Forward Characteristics, High Current, Per Element

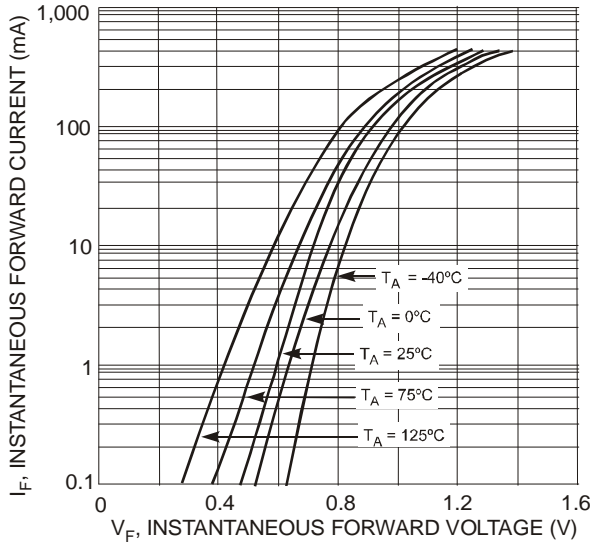

Fig. 3 Typical Forward Characteristics, Low Current, Per Element

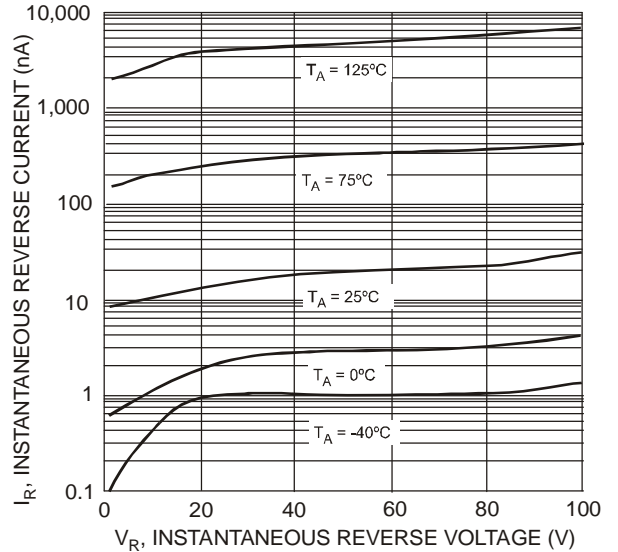

Fig. 4 Typical Reverse Characteristics, Per Element

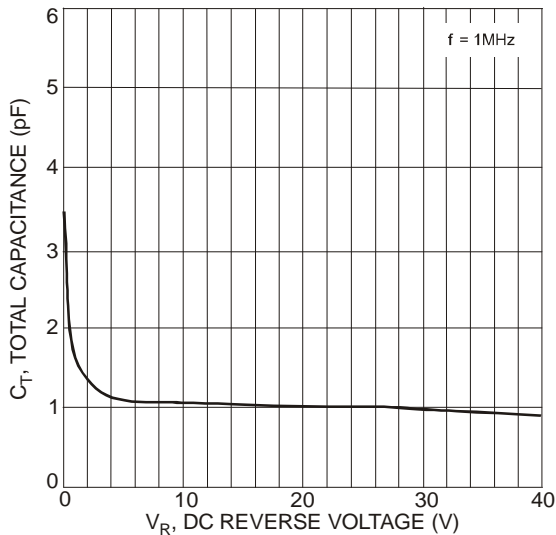

Fig. 5 Total Capacitance vs. Reverse Voltage Per Element

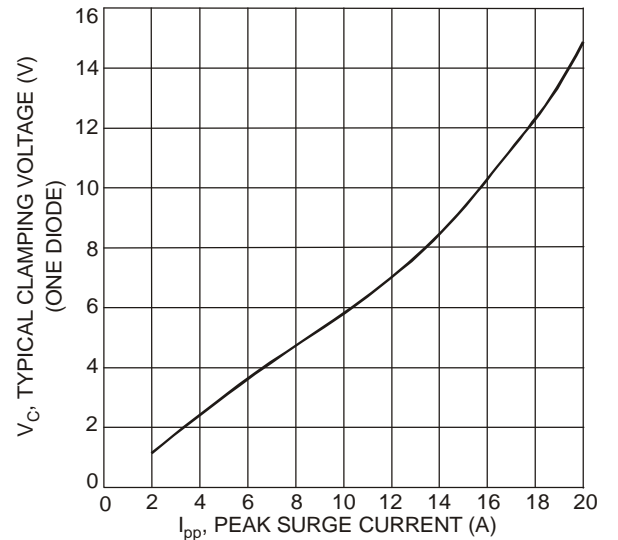
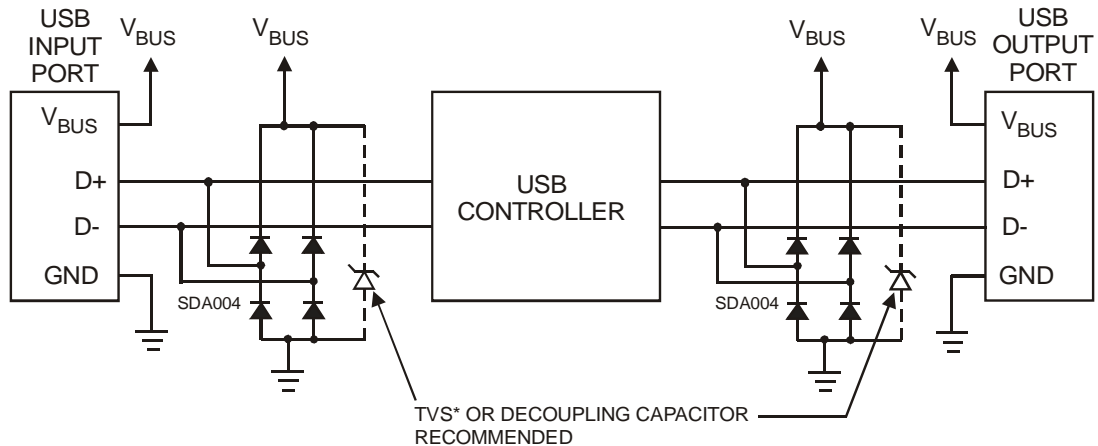

Fig. 6 6100-4-5 8x20µs Surge Response, Per Element



\* MMBZ6V8AL OR EQUIVALENT

**ESD PROTECTION - USB APPLICATION**

**Package Outline Dimensions**

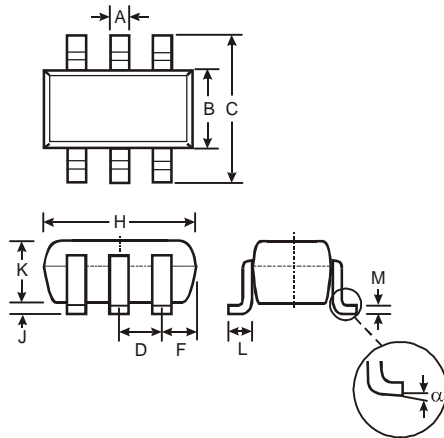

SOT-363		
Dim	Min	Max
A	0.10	0.30
B	1.15	1.35
C	2.00	2.20
D	0.65 Typ	
F	0.40	0.45
H	1.80	2.20
J	0	0.10
K	0.90	1.00
L	0.25	0.40
M	0.10	0.22
α	0°	8°
All Dimensions in mm		

**Suggested Pad Layout**

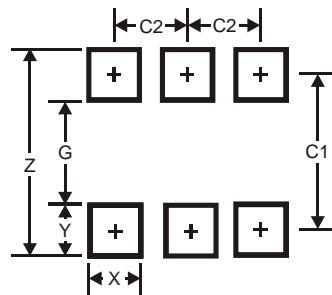

Dimensions	Value (in mm)
Z	2.5
G	1.3
X	0.42
Y	0.6
C1	1.9
C2	0.65

**IMPORTANT NOTICE**

DIODES INCORPORATED MAKES NO WARRANTY OF ANY KIND, EXPRESS OR IMPLIED, WITH REGARDS TO THIS DOCUMENT, INCLUDING, BUT NOT LIMITED TO, THE IMPLIED WARRANTIES OF MERCHANTABILITY AND FITNESS FOR A PARTICULAR PURPOSE (AND THEIR EQUIVALENTS UNDER THE LAWS OF ANY JURISDICTION).

Diodes Incorporated and its subsidiaries reserve the right to make modifications, enhancements, improvements, corrections or other changes without further notice to this document and any product described herein. Diodes Incorporated does not assume any liability arising out of the application or use of this document or any product described herein; neither does Diodes Incorporated convey any license under its patent or trademark rights, nor the rights of others. Any Customer or user of this document or products described herein in such applications shall assume all risks of such use and will agree to hold Diodes Incorporated and all the companies whose products are represented on Diodes Incorporated website, harmless against all damages.

Diodes Incorporated does not warrant or accept any liability whatsoever in respect of any products purchased through unauthorized sales channel. Should Customers purchase or use Diodes Incorporated products for any unintended or unauthorized application, Customers shall indemnify and hold Diodes Incorporated and its representatives harmless against all claims, damages, expenses, and attorney fees arising out of, directly or indirectly, any claim of personal injury or death associated with such unintended or unauthorized application.

Products described herein may be covered by one or more United States, international or foreign patents pending. Product names and markings noted herein may also be covered by one or more United States, international or foreign trademarks.

**LIFE SUPPORT**

Diodes Incorporated products are specifically not authorized for use as critical components in life support devices or systems without the express written approval of the Chief Executive Officer of Diodes Incorporated. As used herein:

A. Life support devices or systems are devices or systems which:

1. are intended to implant into the body, or
2. support or sustain life and whose failure to perform when properly used in accordance with instructions for use provided in the labeling can be reasonably expected to result in significant injury to the user.

B. A critical component is any component in a life support device or system whose failure to perform can be reasonably expected to cause the failure of the life support device or to affect its safety or effectiveness.

Customers represent that they have all necessary expertise in the safety and regulatory ramifications of their life support devices or systems, and acknowledge and agree that they are solely responsible for all legal, regulatory and safety-related requirements concerning their products and any use of Diodes Incorporated products in such safety-critical, life support devices or systems, notwithstanding any devices- or systems-related information or support that may be provided by Diodes Incorporated. Further, Customers must fully indemnify Diodes Incorporated and its representatives against any damages arising out of the use of Diodes Incorporated products in such safety-critical, life support devices or systems.

Copyright © 2011, Diodes Incorporated

[www.diodes.com](http://www.diodes.com)