

## Product Summary

$BV_{DSS}$	$R_{DS(ON)}$ Max	$I_D$ Max $T_A = +25^\circ C$
-20V	45m $\Omega$ @ $V_{GS} = -4.5V$	-4.7A
	90m $\Omega$ @ $V_{GS} = -1.8V$	-3.3A

## Description and Applications

This MOSFET is designed to minimize the on-state resistance ( $R_{DS(ON)}$ ) and yet maintain superior switching performance, making it ideal for high-efficiency power management applications.

- Backlighting
- Power Management Functions
- DC-DC Converters



ESD protected Gate

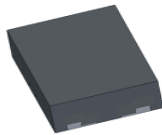

TOP VIEW

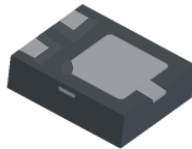

BOTTOM VIEW

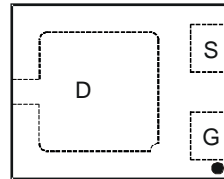

Internal Schematic  
(Top View)

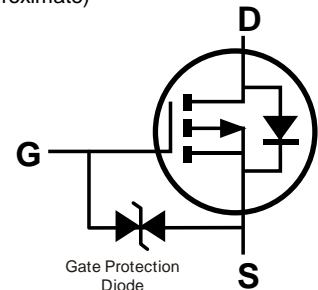

Equivalent Circuit

## Features and Benefits

- Low On-Resistance
- Low Input Capacitance
- Fast Switching Speed
- Low Input/Output Leakage
- **ESD Protected**
- **Totally Lead-Free & Fully RoHS Compliant (Notes 1 & 2)**
- **Halogen and Antimony Free. "Green" Device (Note 3)**

## Mechanical Data

- Case: X2-DFN2015-3
- Case Material: Molded Plastic, "Green" Molding Compound. UL Flammability Classification Rating 94V-0
- Moisture Sensitivity: Level 1 per J-STD-020
- Terminals: Finish — NiPdAu over Copper Leadframe. Solderable per MIL-STD-202, Method 208
- Terminals Connections: See Diagram Below
- Weight: 0.008 grams (Approximate)

## Ordering Information (Note 4)

Part Number	Case	Packaging
DMP2045UFY4-7	X2-DFN2015-3	3,000/Tape & Reel

- Notes:
1. No purposely added lead. Fully EU Directive 2002/95/EC (RoHS), 2011/65/EU (RoHS 2) & 2015/863/EU (RoHS 3) compliant.
  2. See [http://www.diodes.com/quality/lead\\_free/](http://www.diodes.com/quality/lead_free/) for more information about Diodes Incorporated's definitions of Halogen- and Antimony-free, "Green" and Lead-free.
  3. Halogen- and Antimony-free "Green" products are defined as those which contain <900ppm bromine, <900ppm chlorine (<1500ppm total Br + Cl) and <1000ppm antimony compounds.
  4. For packaging details, go to our website at <https://www.diodes.com/design/support/packaging/diodes-packaging/>.

## Marking Information

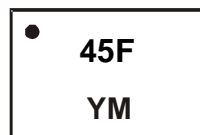

45F = Marking Code  
 YM = Date Code Marking  
 Y = Year (ex: F = 2018)  
 M = Month (ex: 9 = September)

### Date Code Key

Year	2017	2018	2019	2020	2021	2022	2023	2024	2025
Code	E	F	G	H	I	J	K	L	M

Month	Jan	Feb	Mar	Apr	May	Jun	Jul	Aug	Sep	Oct	Nov	Dec
Code	1	2	3	4	5	6	7	8	9	O	N	D

**Maximum Ratings** (@ $T_A = +25^\circ\text{C}$ , unless otherwise specified.)

Characteristic	Symbol	Value	Unit
Drain-Source Voltage	$V_{DSS}$	-20	V
Gate-Source Voltage	$V_{GSS}$	$\pm 8$	V
Continuous Drain Current (Note 6) $V_{GS} = -4.5\text{V}$	$I_D$	$T_A = +25^\circ\text{C}$	-4.7
		$T_A = +70^\circ\text{C}$	-3.8
Maximum Continuous Body Diode Forward Current (Note 6)	$I_S$	-1	A
Pulsed Drain Current (10 $\mu\text{s}$ Pulse, Duty Cycle = 1%)	$I_{DM}$	-25	A

**Thermal Characteristics**

Characteristic	Symbol	Value	Unit
Total Power Dissipation (Note 5)	$P_D$	0.67	W
Thermal Resistance, Junction to Ambient (Note 5)	$R_{\theta JA}$	Steady State	190
Total Power Dissipation (Note 6)		$P_D$	1.49
Thermal Resistance, Junction to Ambient (Note 6)	$R_{\theta JA}$	Steady State	84
Thermal Resistance, Junction to Case (Note 6)		$R_{\theta JC}$	14.5
Operating and Storage Temperature Range	$T_J, T_{STG}$	-55 to +150	$^\circ\text{C}$

**Electrical Characteristics** (@ $T_A = +25^\circ\text{C}$ , unless otherwise specified.)

Characteristic	Symbol	Min	Typ	Max	Unit	Test Condition
<b>OFF CHARACTERISTICS (Note 7)</b>						
Drain-Source Breakdown Voltage	$BV_{DSS}$	-20	—	—	V	$V_{GS} = 0\text{V}, I_D = -250\mu\text{A}$
Zero Gate Voltage Drain Current $T_J = +25^\circ\text{C}$	$I_{DSS}$	—	—	-1	$\mu\text{A}$	$V_{DS} = -20\text{V}, V_{GS} = 0\text{V}$
Gate-Source Leakage	$I_{GSS}$	—	—	$\pm 10$	$\mu\text{A}$	$V_{GS} = \pm 8.0\text{V}, V_{DS} = 0\text{V}$
<b>ON CHARACTERISTICS (Note 7)</b>						
Gate Threshold Voltage	$V_{GS(TH)}$	-0.3	—	-1.0	V	$V_{DS} = V_{GS}, I_D = -250\mu\text{A}$
Static Drain-Source On-Resistance	$R_{DS(ON)}$	—	34	45	m $\Omega$	$V_{GS} = -4.5\text{V}, I_D = -4.0\text{A}$
		—	44	58		$V_{GS} = -2.5\text{V}, I_D = -3.5\text{A}$
		—	56	90		$V_{GS} = -1.8\text{V}, I_D = -0.1\text{A}$
		—	80	160		$V_{GS} = -1.5\text{V}, I_D = -0.1\text{A}$
Diode Forward Voltage	$V_{SD}$	—	-0.6	-1.2	V	$V_{GS} = 0\text{V}, I_S = 1.0\text{A}$
<b>DYNAMIC CHARACTERISTICS (Note 8)</b>						
Input Capacitance	$C_{iss}$	—	634	—	pF	$V_{DS} = -10\text{V}, V_{GS} = 0\text{V}$ $f = 1.0\text{MHz}$
Output Capacitance	$C_{oss}$	—	81	—	pF	
Reverse Transfer Capacitance	$C_{rss}$	—	66	—	pF	
Gate Resistance	$R_g$	—	20	—	$\Omega$	$V_{DS} = 0\text{V}, V_{GS} = 0\text{V}, f = 1.0\text{MHz}$
Total Gate Charge	$Q_g$	—	6.8	—	nC	$V_{GS} = -4.5\text{V}, V_{DS} = -10\text{V}$ $I_D = -4\text{A}$
Gate-Source Charge	$Q_{gs}$	—	0.7	—	nC	
Gate-Drain Charge	$Q_{gd}$	—	1.6	—	nC	
Turn-On Delay Time	$t_{D(ON)}$	—	4.2	—	ns	$V_{DS} = -10\text{V}, V_{GS} = -4.5\text{V},$ $R_D = 2.5\Omega, R_g = 3.0\Omega, I_D = -1\text{A}$
Turn-On Rise Time	$t_R$	—	3.4	—	ns	
Turn-Off Delay Time	$t_{D(OFF)}$	—	22.7	—	ns	
Turn-Off Fall Time	$t_F$	—	9.6	—	ns	
Reverse Recovery Time	$t_{RR}$	—	1.8	—	ns	$I_F = -1.0\text{A}, di/dt = 100\text{A}/\mu\text{s}$
Reverse Recovery Charge	$Q_{RR}$	—	9.4	—	nC	$I_F = -1.0\text{A}, di/dt = 100\text{A}/\mu\text{s}$

- Notes: 5. Device mounted on FR-4 substrate PC board, 2oz copper, with minimum recommended pad layout.  
6. Device mounted on FR-4 substrate PC board, 2oz copper, with 1inch square copper plate.  
7. Short duration pulse test used to minimize self-heating effect.  
8. Guaranteed by design. Not subject to product testing.

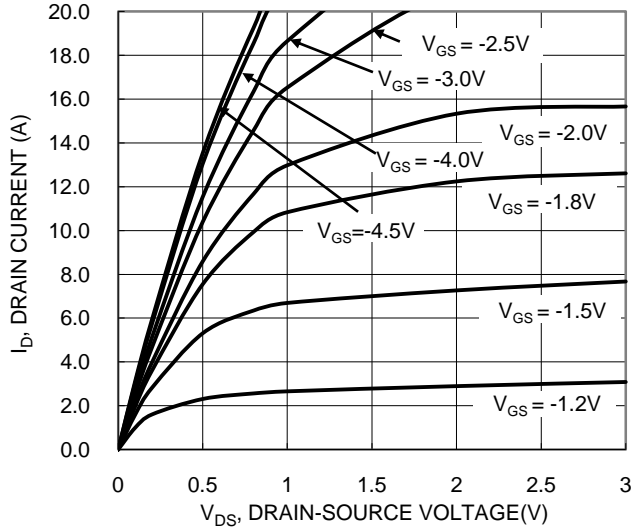

Figure 1. Typical Output Characteristic

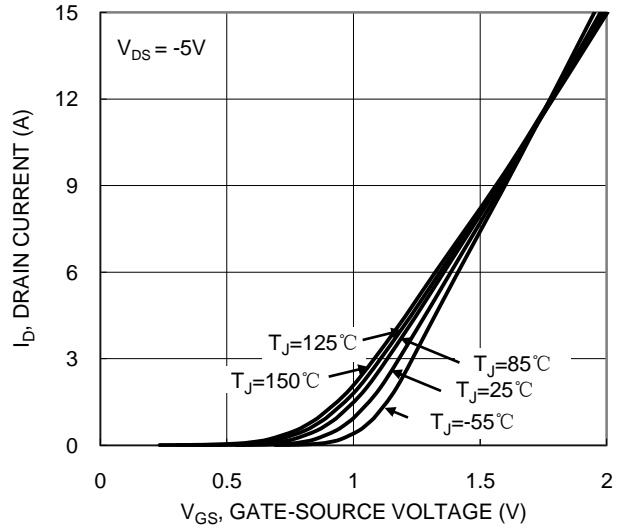

Figure 2. Typical Transfer Characteristic

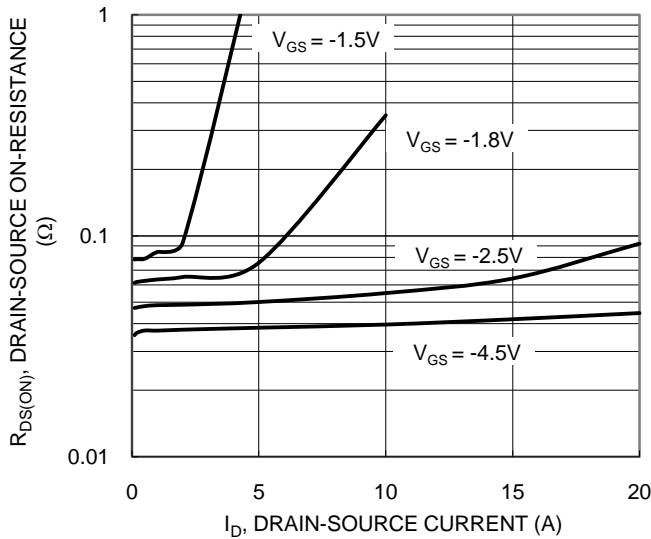

Figure 3. Typical On-Resistance vs. Drain Current and Gate Voltage

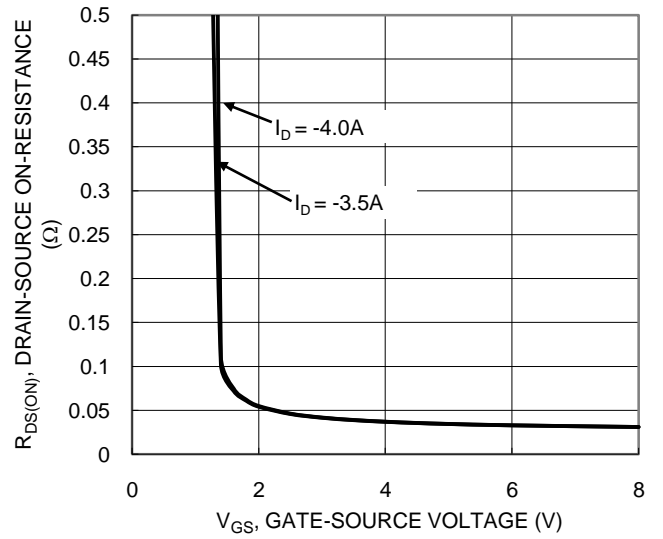

Figure 4. Typical Transfer Characteristic

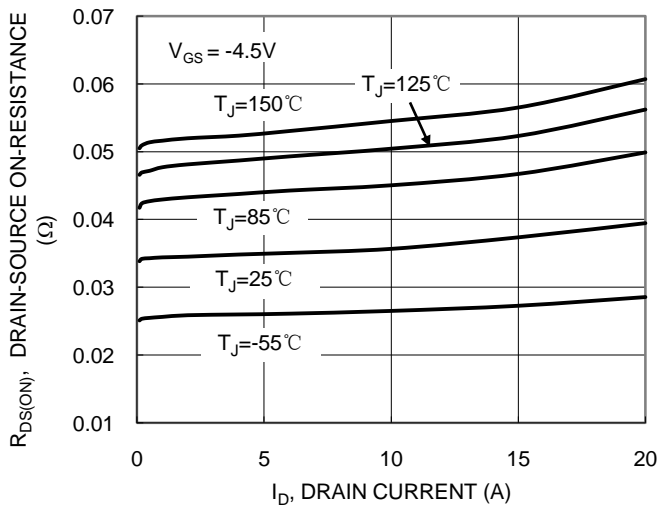

Figure 5. Typical On-Resistance vs. Drain Current and Junction Temperature

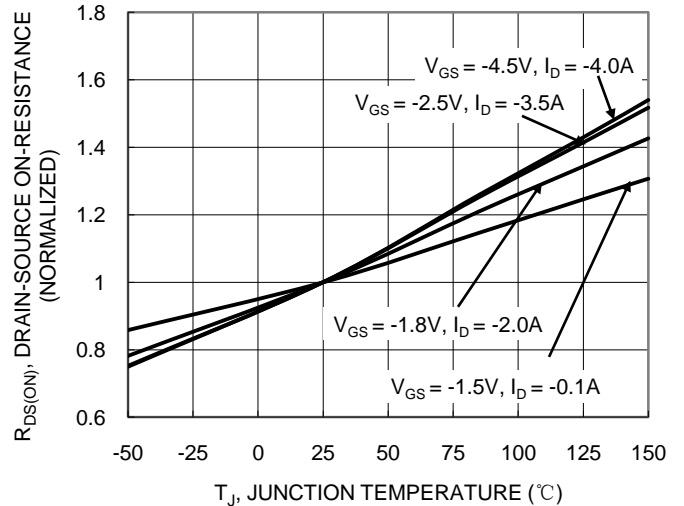
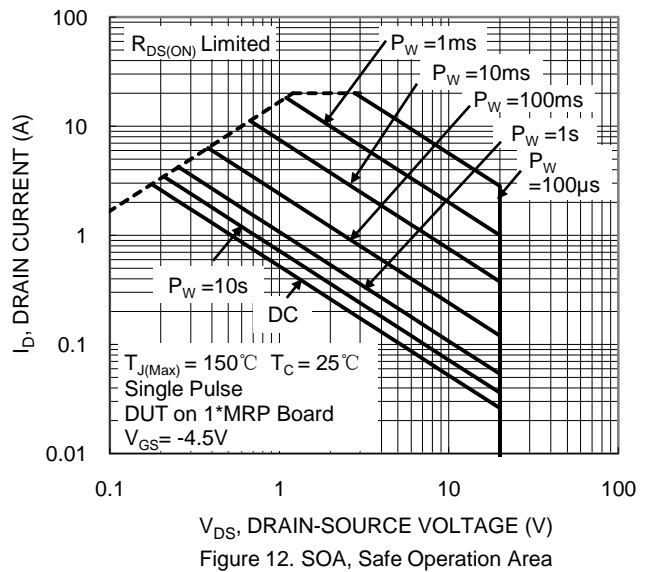
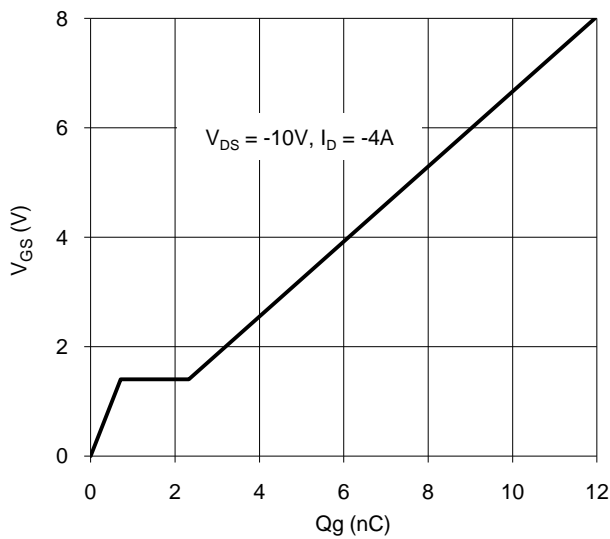
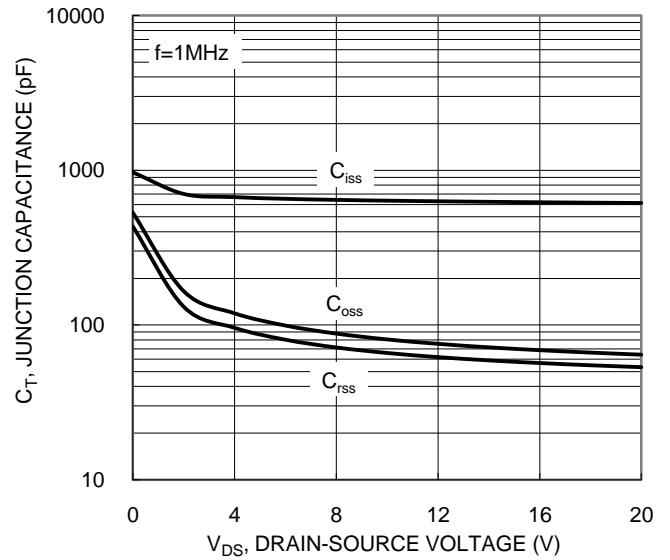
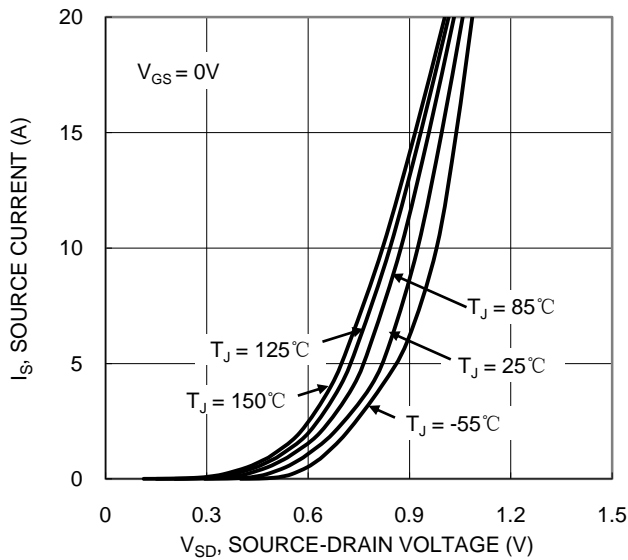
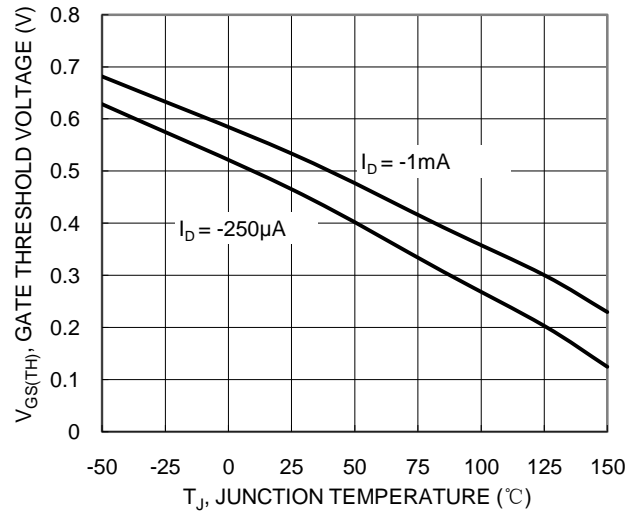
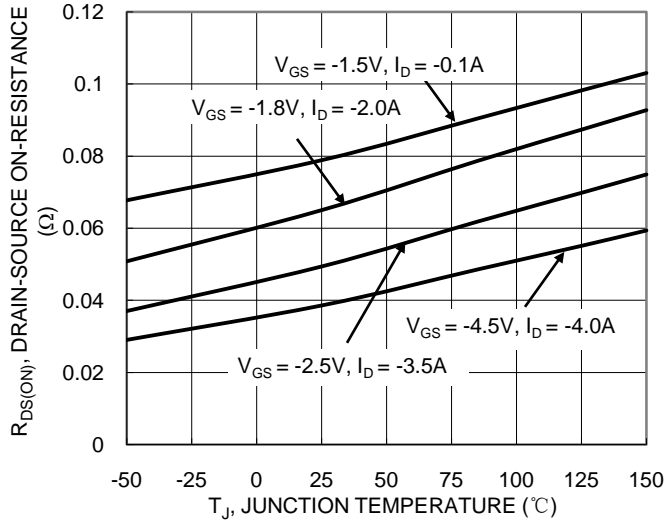

Fig.5 On-Resistance Variation with Junction Temperature



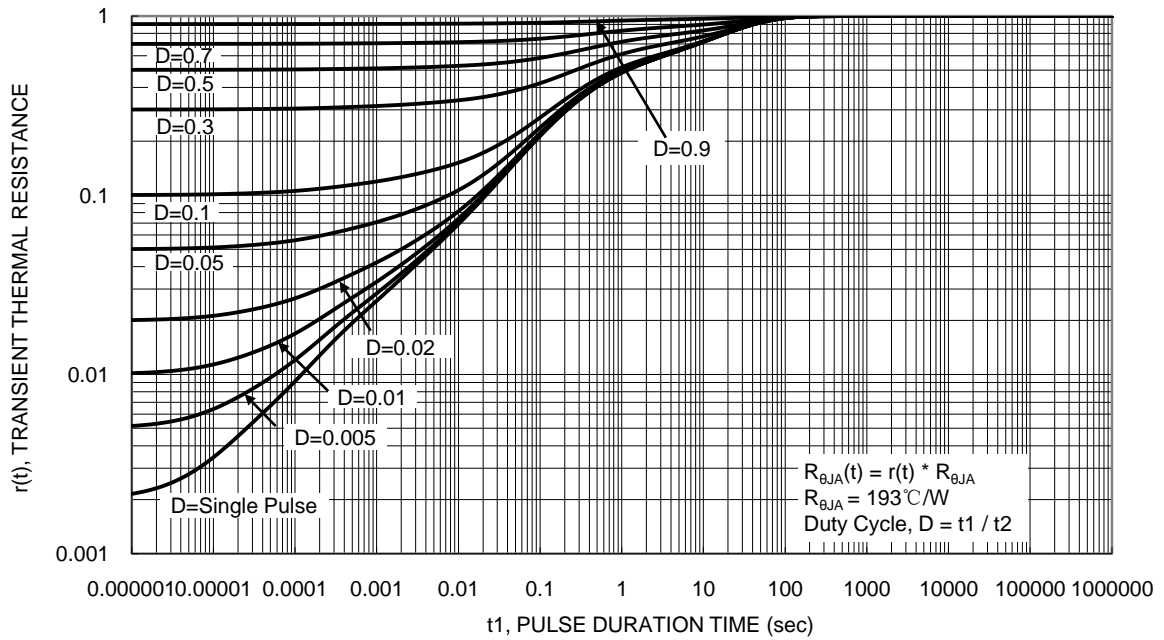
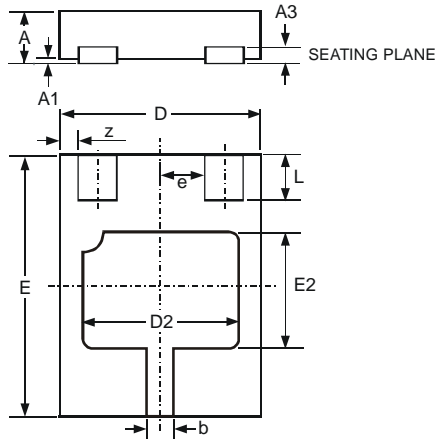

Figure 13. Transient Thermal Resistance

**Package Outline Dimensions**

Please see <http://www.diodes.com/package-outlines.html> for the latest version.

**X2-DFN2015-3**



X2-DFN2015-3			
Dim	Min	Max	Typ
A	-	0.40	-
A1	0	0.05	0.02
A3	-	-	0.13
b	0.20	0.30	0.25
D	1.45	1.575	1.5
D2	1.00	1.20	1.10
e	-	-	0.50
E	1.95	2.075	2.00
E2	0.70	0.90	0.80
L	0.25	0.35	0.30
z	-	-	0.125
All Dimensions in mm			

**Suggested Pad Layout**

Please see <http://www.diodes.com/package-outlines.html> for the latest version.

**X2-DFN2015-3**

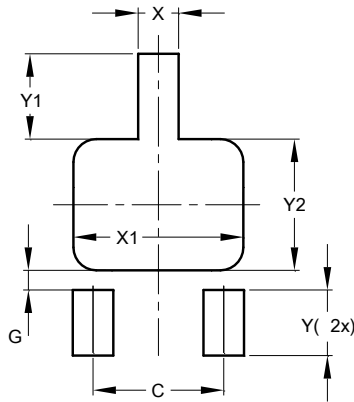

X2-DFN2015-3	
Dimensions	Value (in mm)
C	1.000
G	0.150
X	0.310
X1	1.300
Y	0.500
Y1	0.650
Y2	1.000

**IMPORTANT NOTICE**

DIODES INCORPORATED MAKES NO WARRANTY OF ANY KIND, EXPRESS OR IMPLIED, WITH REGARDING TO THIS DOCUMENT, INCLUDING, BUT NOT LIMITED TO, THE IMPLIED WARRANTIES OF MERCHANTABILITY AND FITNESS FOR A PARTICULAR PURPOSE (AND THEIR EQUIVALENTS UNDER THE LAWS OF ANY JURISDICTION).

Diodes Incorporated and its subsidiaries reserve the right to make modifications, enhancements, improvements, corrections or other changes without further notice to this document and any product described herein. Diodes Incorporated does not assume any liability arising out of the application or use of this document or any product described herein; neither does Diodes Incorporated convey any license under its patent or trademark rights, nor the rights of others. Any Customer or user of this document or products described herein in such applications shall assume all risks of such use and will agree to hold Diodes Incorporated and all the companies whose products are represented on Diodes Incorporated website, harmless against all damages.

Diodes Incorporated does not warrant or accept any liability whatsoever in respect of any products purchased through unauthorized sales channel. Should Customers purchase or use Diodes Incorporated products for any unintended or unauthorized application, Customers shall indemnify and hold Diodes Incorporated and its representatives harmless against all claims, damages, expenses, and attorney fees arising out of, directly or indirectly, any claim of personal injury or death associated with such unintended or unauthorized application.

Products described herein may be covered by one or more United States, international or foreign patents pending. Product names and markings noted herein may also be covered by one or more United States, international or foreign trademarks.

This document is written in English but may be translated into multiple languages for reference. Only the English version of this document is the final and determinative format released by Diodes Incorporated.

**LIFE SUPPORT**

Diodes Incorporated products are specifically not authorized for use as critical components in life support devices or systems without the express written approval of the Chief Executive Officer of Diodes Incorporated. As used herein:

A. Life support devices or systems are devices or systems which:

1. are intended to implant into the body, or
2. support or sustain life and whose failure to perform when properly used in accordance with instructions for use provided in the labeling can be reasonably expected to result in significant injury to the user.

B. A critical component is any component in a life support device or system whose failure to perform can be reasonably expected to cause the failure of the life support device or to affect its safety or effectiveness.

Customers represent that they have all necessary expertise in the safety and regulatory ramifications of their life support devices or systems, and acknowledge and agree that they are solely responsible for all legal, regulatory and safety-related requirements concerning their products and any use of Diodes Incorporated products in such safety-critical, life support devices or systems, notwithstanding any devices- or systems-related information or support that may be provided by Diodes Incorporated. Further, Customers must fully indemnify Diodes Incorporated and its representatives against any damages arising out of the use of Diodes Incorporated products in such safety-critical, life support devices or systems.

Copyright © 2018, Diodes Incorporated

[www.diodes.com](http://www.diodes.com)