

## Features

- 500mW Power Dissipation on Ceramic PCB
- Tight Tolerance on  $V_Z$
- Ideally Suited for Automated Assembly Processes
- **Lead, Halogen and Antimony Free, RoHS Compliant (Note 2)**
- **"Green" Device (Note 3)**

## Mechanical Data

- Case: SOD-123
- Case Material: Molded Plastic. UL Flammability Classification Rating 94V-0
- Moisture Sensitivity: Level 1 per J-STD-020
- Terminal Connections: Cathode Band
- Terminals: Finish - Matte Tin annealed over Alloy 42 leadframe. Solderable per MIL-STD-202, Method 208
- Marking Information: See Page 6
- Ordering Information: See Page 6
- Weight: 0.01 grams (approximate)



Top View

## Maximum Ratings @ $T_A = 25^\circ\text{C}$ unless otherwise specified

Characteristic	Symbol	Value	Unit
Forward Voltage @ $I_F = 10\text{mA}$	$V_F$	0.9	V

## Thermal Characteristics

Characteristic	Symbol	Value	Unit
Power Dissipation (Note 1)	$P_D$	500	mW
Thermal Resistance, Junction to Ambient Air (Note 1)	$R_{\theta JA}$	305	$^\circ\text{C/W}$
Operating and Storage Temperature Range	$T_J, T_{STG}$	-65 to +150	$^\circ\text{C}$

- Notes:
1. Device mounted on ceramic PCB = 7.6mm x 9.4mm x 0.87mm with pad areas 25mm<sup>2</sup> at  $T_A = 25^\circ\text{C}$  or mounted on FR-5 = 3.5x1.5 inches with recommended pad layout, which can be found on our website at <http://www.diodes.com/datasheets/ap02001.pdf>, at  $T_L = 75^\circ\text{C}$ .
  2. No purposefully added lead. Halogen and Antimony Free.
  3. Product manufactured with Data Code V9 (week 33, 2008) and newer are built with Green Molding Compound. Product manufactured prior to Date Code V9 are built with Non-Green Molding Compound and may contain Halogens or  $\text{Sb}_2\text{O}_3$  Fire Retardants.

**Electrical Characteristics** @ $T_A = 25^\circ\text{C}$  unless otherwise specified

Type Number	Type Code	Zener Voltage Range (Note 4)				Maximum Reverse Leakage Current (Note 5)		
		$V_Z @ I_{ZT}$			$I_{ZT}$	$I_R @ V_R$		
		Nom (V)	Min (V)	Max (V)		$\mu\text{A}$	V	
DDZ9678	D1	1.8	1.71	1.89	50	7.5	1	
DDZ9681	H9	2.4	2.28	2.52	50	2	1	
DDZ9682	HA	2.7	2.565	2.835	50	1	1	
DDZ9683	HB	3.0	2.85	3.15	50	0.8	1	
DDZ9684	HC	3.3	3.13	3.47	50	7.5	1.5	
DDZ9685	HD	3.6	3.42	3.78	50	7.5	2	
DDZ9686	HE	3.9	3.70	4.10	50	5	2	
DDZ9687	HF	4.3	4.09	4.52	50	4	2	
DDZ9688 (Note 6)	HG	4.7	4.47	4.94	50	5	3	
DDZ9689	HH	5.1	4.85	5.36	50	5	3	
DDZ9690	HJ	5.6	5.32	5.88	50	2	4	
DDZ9691	HK	6.2	5.89	6.51	50	1	5	
DDZ9692	HL	6.8	6.46	7.14	50	0.1	5.1	
DDZ9693	HM	7.5	7.13	7.88	50	0.1	5.7	
DDZ9694	HN	8.2	7.79	8.61	50	0.1	6.2	
DDZ9696	HP	9.1	8.65	9.56	50	0.1	6.9	
DDZ9697	HQ	10	9.50	10.50	50	0.1	7.6	
DDZ9698	HR	11	10.45	11.55	50	0.05	8.4	
DDZ9699	HS	12	11.40	12.60	50	0.05	9.1	
DDZ9700	HT	13	12.35	13.65	50	0.05	9.8	
DDZ9701 (Note 6)	HU	14	13.30	14.70	50	0.05	10.6	
DDZ9702	HV	15	14.25	15.75	50	0.05	11.4	
DDZ9703	HW	16	15.20	16.80	50	0.05	12.1	
DDZ9704 (Note 6)	H8	17	16.15	17.85	50	0.05	12.9	
DDZ9705	HY	18	17.10	18.90	50	0.05	13.6	
DDZ9707	MD	20	19.00	21.00	50	0.05	15.2	
DDZ9708	ME	22	20.90	23.10	50	0.05	16.7	
DDZ9709	MF	24	22.80	25.20	50	0.05	18.2	
DDZ9711	MH	27	25.65	28.35	50	0.05	20.4	
DDZ9712	MJ	28	26.60	29.40	50	0.05	21.2	
DDZ9713	MK	30	28.50	31.50	50	0.05	22.8	
DDZ9714	ML	33	31.35	34.65	50	0.05	25.0	
DDZ9715	MM	36	34.20	37.80	50	0.05	27.3	
DDZ9716	MN	39	37.05	40.95	50	0.05	29.6	
DDZ9717	MO	43	40.85	45.15	50	0.05	32.6	

- Notes:
- Nominal Zener voltage is measured with the device junction in thermal equilibrium at  $T_T = 30^\circ\text{C} \pm 1^\circ\text{C}$ .
  - Short duration pulse test used to minimize self-heating effect.
  - Qualified to AEC-Q101 Standards for High Reliability. Please contact the Diodes, Inc. sales department for assistance in ordering any products expected to meet automotive requirements.

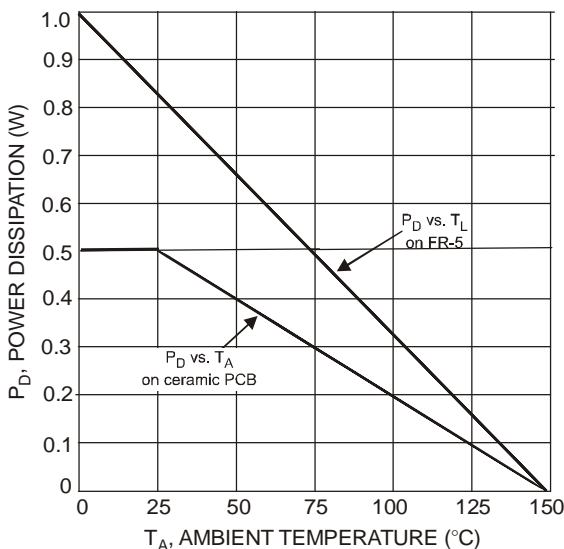

Fig. 1 Power Derating Curve

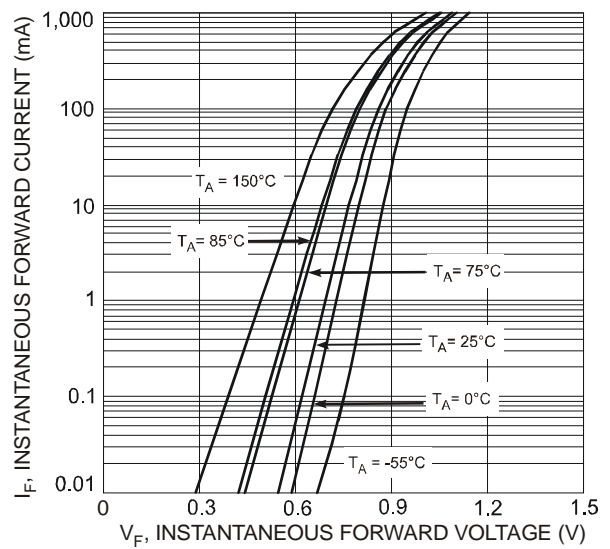

Fig. 2 Typical Forward Characteristics

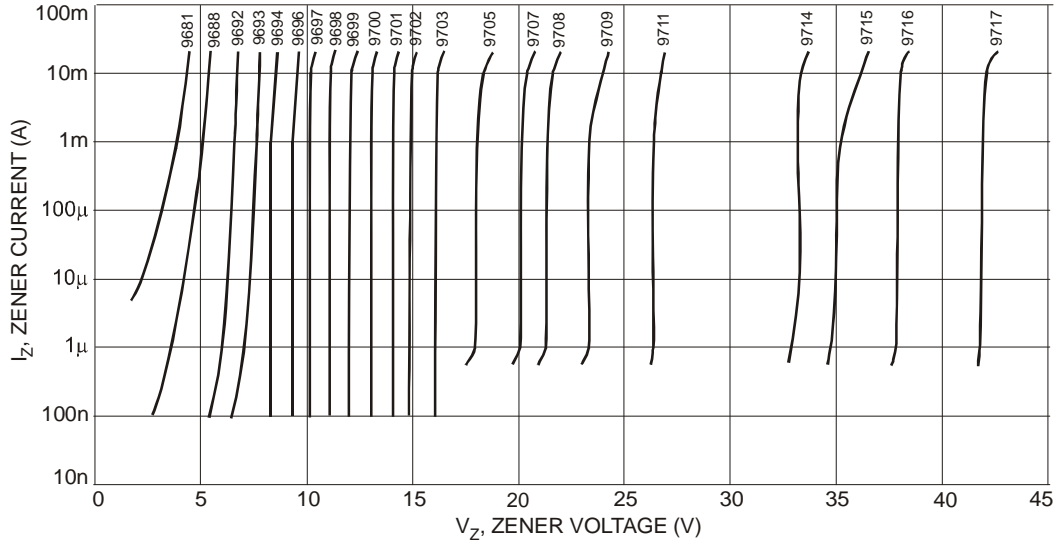

Fig. 3 Typical Zener Breakdown Characteristics

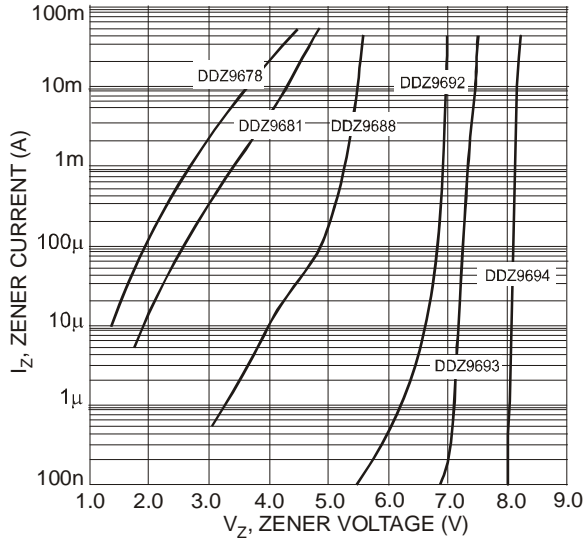

Fig. 4 Typical Zener Breakdown Characteristics, DDZ9678 - DDZ9694

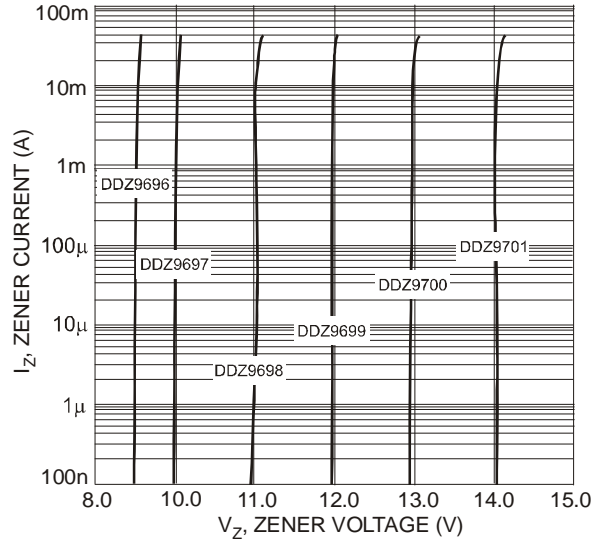

Fig. 5 Typical Zener Breakdown Characteristics, DDZ9696 - DDZ9701

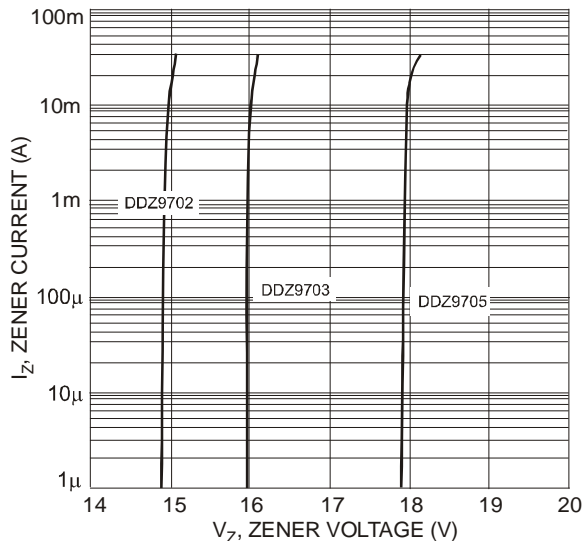

Fig. 6 Typical Zener Breakdown Characteristics, DDZ9702 - DDZ9705

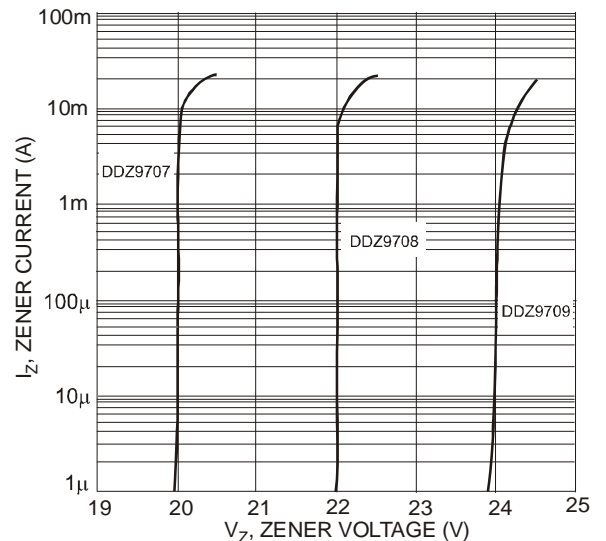

Fig. 7 Typical Zener Breakdown Characteristics, DDZ9707 - DDZ9709

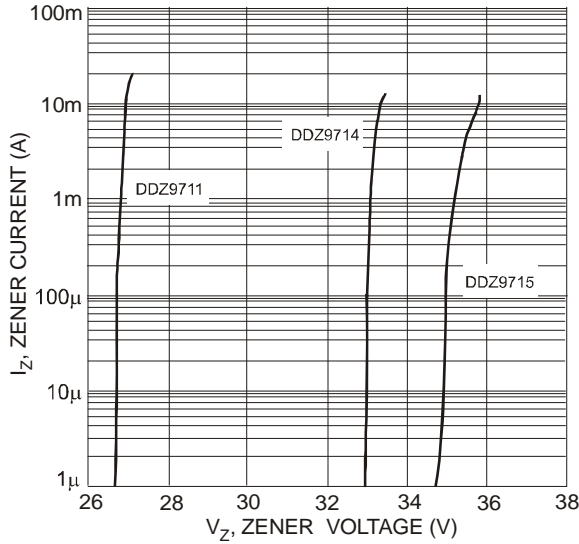

Fig. 8 Typical Zener Breakdown Characteristics, DDZ9711 - DDZ9715

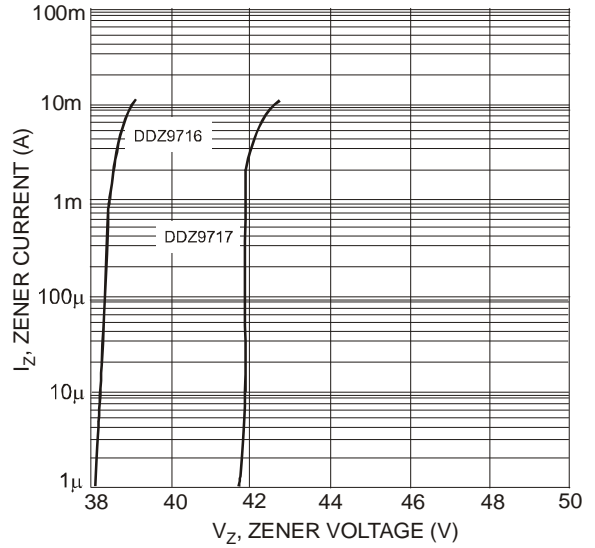

Fig. 9 Typical Zener Breakdown Characteristics, DDZ9716 - DDZ9717

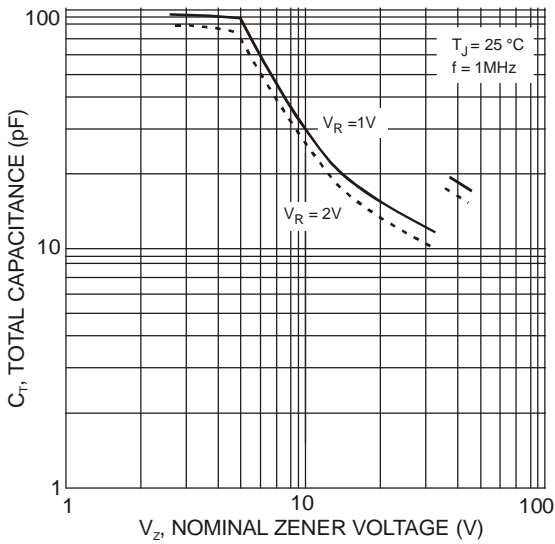

Fig. 10 Total Capacitance vs. Nominal Zener Voltage

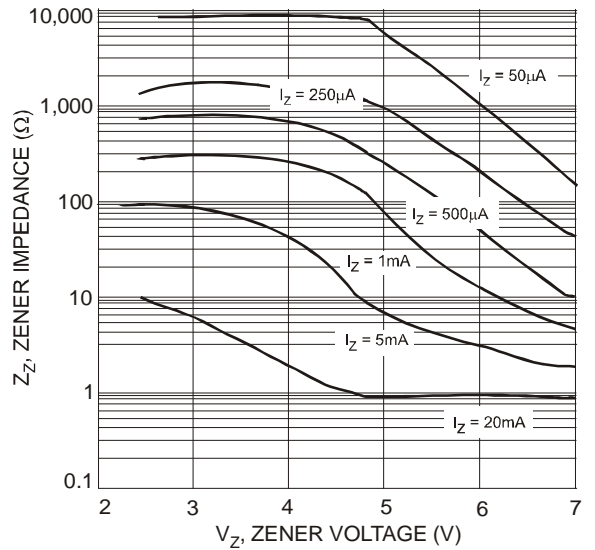

Fig. 11 Typical Zener Impedance Characteristics, DDZ9681 - DDZ9692

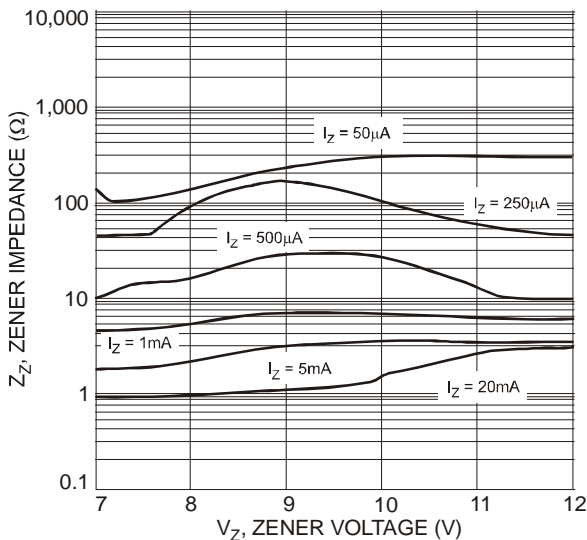

Fig. 12 Typical Zener Impedance Characteristics, DDZ9693 - DDZ9699

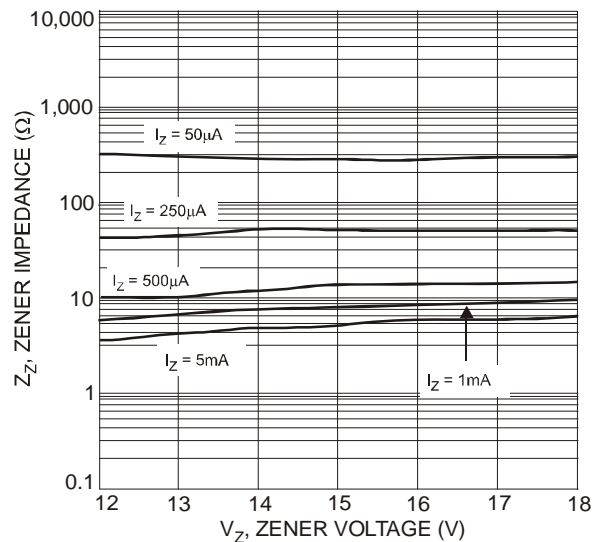

Fig. 13 Typical Zener Impedance Characteristics, DDZ9699 - DDZ9705

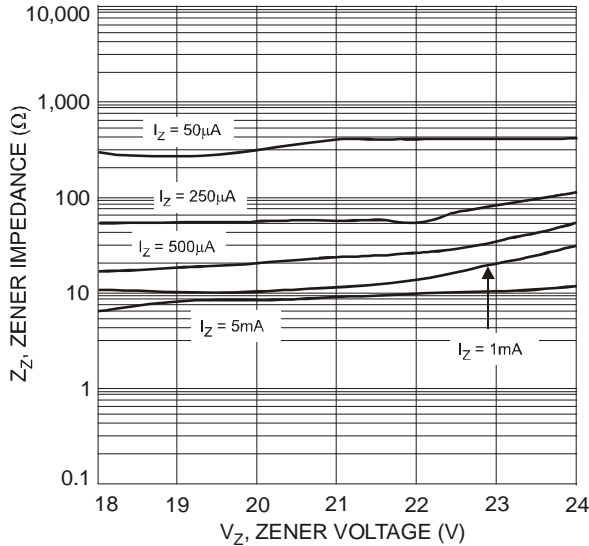

Fig. 14 Typical Zener Impedance Characteristics, DDZ9705 - DDZ9709

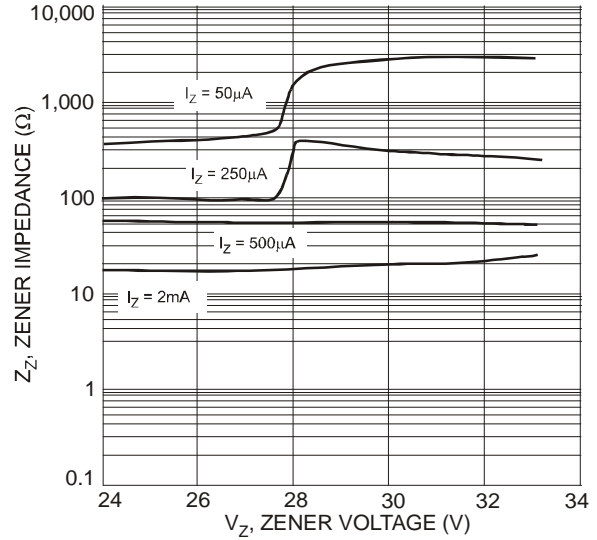

Fig. 15 Typical Zener Impedance Characteristics, DDZ9709 - DDZ9714

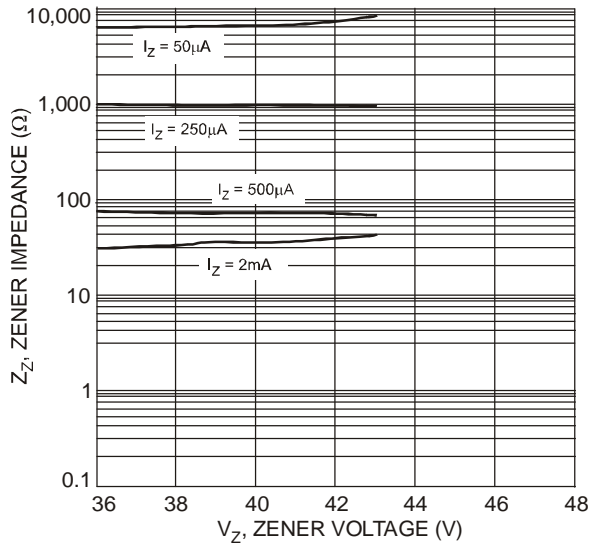

Fig. 16 Typical Zener Impedance Characteristics, DDZ9715 - DDZ9717

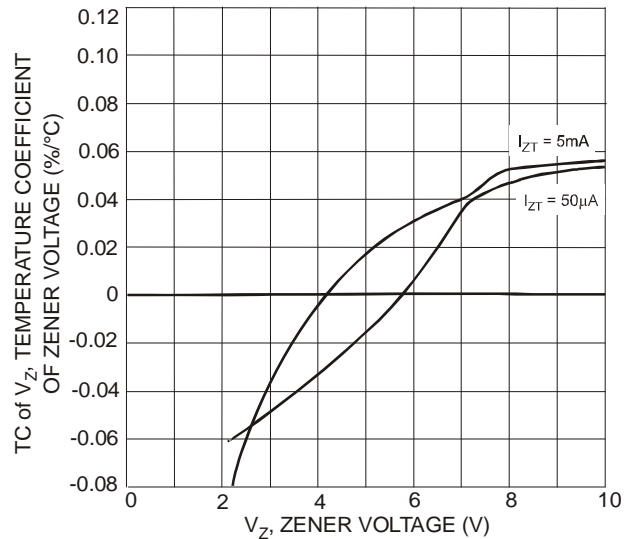

Fig. 17 Typical Temperature Coefficient of Zener Voltage vs. Zener Voltage, DDZ9681 - DDZ9697

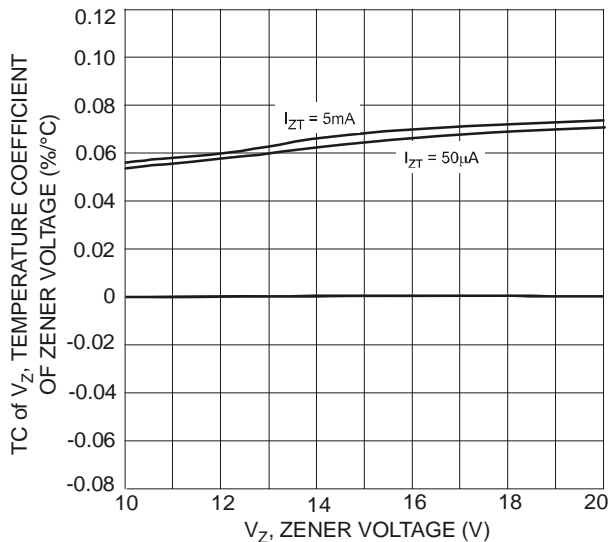

Fig. 18 Typical Temperature Coefficient of Zener Voltage vs. Zener Voltage, DDZ9697 - DDZ9707

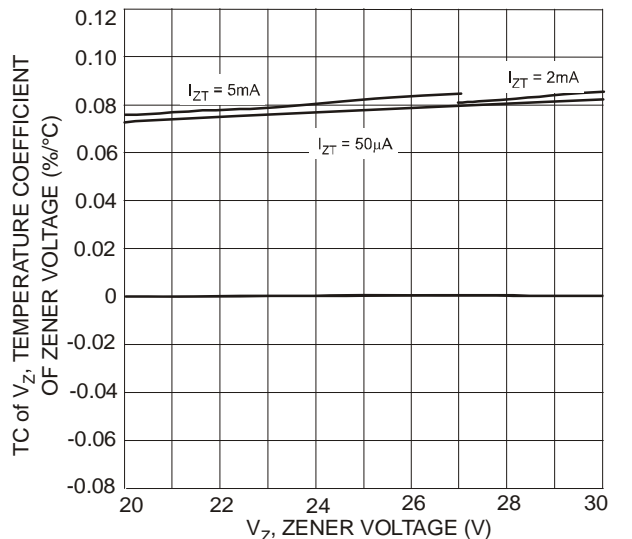

Fig. 19 Typical Temperature Coefficient of Zener Voltage vs. Zener Voltage, DDZ9707 - DDZ9713

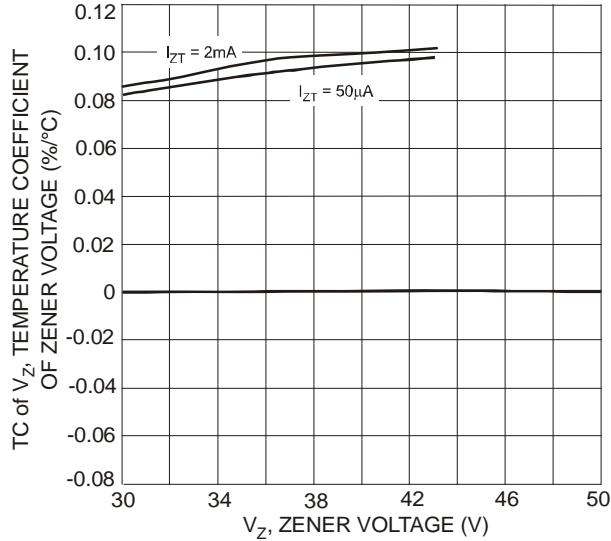

Fig. 20 Typical Temperature Coefficient of Zener Voltage vs. Zener Voltage, DDZ9713 - DDZ9717

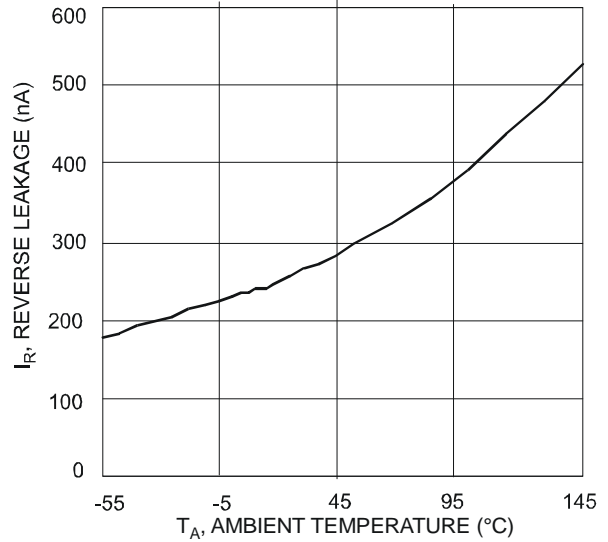

Fig. 21 Typical Leakage vs. Ambient Temperature, DDZ9681

**Ordering Information** (Note 7)

Part Number (Type Number)-7*	Case SOD-123	Packaging 3000/Tape & Reel
---------------------------------	-----------------	-------------------------------

\*Example: The part number for the 6.2 Volt device would be DDZ9691-7.

Notes: 7. For packaging details, go to our website at <http://www.diodes.com/datasheets/ap02007.pdf>.

**Marking Information**



xx = Product Type Marking Code,  
(See Electrical Characteristics Table)  
YM = Date Code Marking  
Y = Year (ex: T = 2006)  
M = Month (ex: 9 = September)

Date Code Key

Year	2006	2007	2008	2009	2010	2011	2012	2013	2014	2015
Code	T	U	V	W	X	Y	Z	A	B	C

Month	Jan	Feb	Mar	Apr	May	Jun	Jul	Aug	Sep	Oct	Nov	Dec
Code	1	2	3	4	5	6	7	8	9	O	N	D

**Package Outline Dimensions**

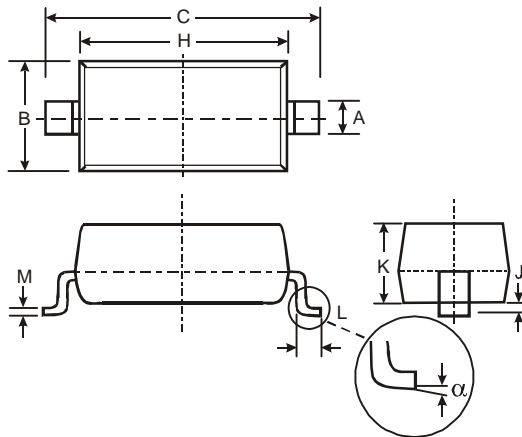

SOD-123		
Dim	Min	Max
A	0.55 Typ	
B	1.40	1.70
C	3.55	3.85
H	2.55	2.85
J	0.00	0.10
K	1.00	1.35
L	0.25	0.40
M	0.10	0.15
α	0	8°
All Dimensions in mm		

## Suggested Pad Layout

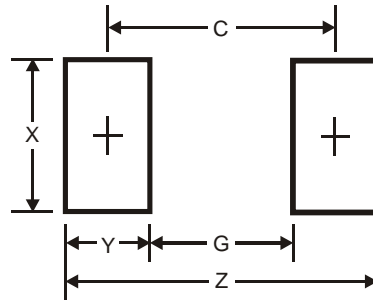

Dimensions	Value (in mm)
Z	4.9
G	2.5
X	0.7
Y	1.2
C	3.7

### IMPORTANT NOTICE

DIODES INCORPORATED MAKES NO WARRANTY OF ANY KIND, EXPRESS OR IMPLIED, WITH REGARDS TO THIS DOCUMENT, INCLUDING, BUT NOT LIMITED TO, THE IMPLIED WARRANTIES OF MERCHANTABILITY AND FITNESS FOR A PARTICULAR PURPOSE (AND THEIR EQUIVALENTS UNDER THE LAWS OF ANY JURISDICTION).

Diodes Incorporated and its subsidiaries reserve the right to make modifications, enhancements, improvements, corrections or other changes without further notice to this document and any product described herein. Diodes Incorporated does not assume any liability arising out of the application or use of this document or any product described herein; neither does Diodes Incorporated convey any license under its patent or trademark rights, nor the rights of others. Any Customer or user of this document or products described herein in such applications shall assume all risks of such use and will agree to hold Diodes Incorporated and all the companies whose products are represented on Diodes Incorporated website, harmless against all damages.

Diodes Incorporated does not warrant or accept any liability whatsoever in respect of any products purchased through unauthorized sales channel. Should Customers purchase or use Diodes Incorporated products for any unintended or unauthorized application, Customers shall indemnify and hold Diodes Incorporated and its representatives harmless against all claims, damages, expenses, and attorney fees arising out of, directly or indirectly, any claim of personal injury or death associated with such unintended or unauthorized application.

Products described herein may be covered by one or more United States, international or foreign patents pending. Product names and markings noted herein may also be covered by one or more United States, international or foreign trademarks.

### LIFE SUPPORT

Diodes Incorporated products are specifically not authorized for use as critical components in life support devices or systems without the express written approval of the Chief Executive Officer of Diodes Incorporated. As used herein:

A. Life support devices or systems are devices or systems which:

1. are intended to implant into the body, or
2. support or sustain life and whose failure to perform when properly used in accordance with instructions for use provided in the labeling can be reasonably expected to result in significant injury to the user.

B. A critical component is any component in a life support device or system whose failure to perform can be reasonably expected to cause the failure of the life support device or to affect its safety or effectiveness.

Customers represent that they have all necessary expertise in the safety and regulatory ramifications of their life support devices or systems, and acknowledge and agree that they are solely responsible for all legal, regulatory and safety-related requirements concerning their products and any use of Diodes Incorporated products in such safety-critical, life support devices or systems, notwithstanding any devices- or systems-related information or support that may be provided by Diodes Incorporated. Further, Customers must fully indemnify Diodes Incorporated and its representatives against any damages arising out of the use of Diodes Incorporated products in such safety-critical, life support devices or systems.

Copyright © 2010, Diodes Incorporated

[www.diodes.com](http://www.diodes.com)