

Product Summary (@T_A = +25°C)

V _{RRM} (V)	I _O (A)	V _F Max (V)	I _R Max (μA)
200	6	1.2	5

Features and Benefits

- Glass Passivated Die Construction
- Ultra-Fast Recovery Time for High Efficiency
- Low Leakage Current
- High Forward Surge Current Capability
- **Lead-Free Finish; RoHS Compliant (Notes 1 & 2)**
- **Halogen and Antimony Free. "Green" Device (Note 3)**

Description

PDU620CT, a 6.0A Glass Passivated Dual Ultra-Fast Recovery Rectifier in our thermally efficient PowerDI[®]5 package, offers ultra-fast recovery time for high efficiency, high forward surge current for use in high frequency inverters, freewheeling and polarity protection applications.

Mechanical Data

- Case: PowerDI5
- Case Material: Molded Plastic, "Green" Molding Compound. UL Flammability Classification Rating 94V-0
- Moisture Sensitivity: Level 1 per J-STD-020
- Terminals: Finish – Matte Tin Annealed over Copper Leadframe. Solderable per MIL-STD-202, Method 208 ③
- Weight: 0.096 grams (Approximate)

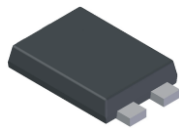

Top View

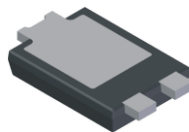

Bottom View

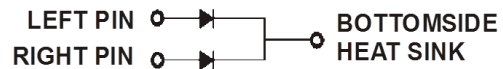
Ordering Information (Note 4)

Part Number	Compliance	Case	Packaging
PDU620CT-13	Commercial	PowerDI5	5,000/Tape & Reel

- Notes:
1. EU Directive 2002/95/EC (RoHS) & 2011/65/EU (RoHS 2) compliant. All applicable RoHS exemptions applied.
 2. See http://www.diodes.com/quality/lead_free.html for more information about Diodes Incorporated's definitions of Halogen- and Antimony-free, "Green" and Lead-free.
 3. Halogen- and Antimony-free "Green" products are defined as those which contain <900ppm bromine, <900ppm chlorine (<1500ppm total Br + Cl) and <1000ppm antimony compounds.
 4. For packaging details, go to our website at <http://www.diodes.com/products/packages.html>.

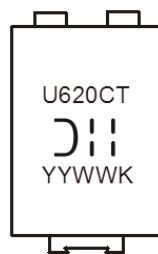
Marking Information

U620CT = Product type marking code
 DIII = Manufacturers' code marking
 YYWW = Date code marking
 YY = Last two digits of year ex: 16 for 2016
 WW = Week code 01 to 52
 K = Factory Designator

Maximum Ratings (@T_A = +25°C, unless otherwise specified.)

Single phase, half wave, 60Hz, resistive or inductive load.
For capacitive load, derate current by 20%.

Characteristic	Symbol	Value	Unit
Peak Repetitive Reverse Voltage Working Peak Reverse Voltage DC Blocking Voltage	V _{RRM} V _{RWM} V _R	200	V
RMS Reverse Voltage	V _{R(RMS)}	141	V
Average Rectified Output Current (See Figure 4)	(Per element) (Total device) I _O	3 6	A
Non-Repetitive Peak Forward Surge Current 8.3ms Single Half Sine-Wave Superimposed on Rated Load	I _{FSM}	90	A

Thermal Characteristics

Characteristic	Symbol	Typ	Max	Unit
Thermal Resistance Junction to Soldering Point	R _{θJS}	—	3.0	°C/W
Thermal Resistance Junction to Ambient Air (Note 5)	T _A = +25°C R _{θJA}	80	—	°C/W
Thermal Resistance Junction to Ambient Air (Note 6)	T _A = +25°C R _{θJA}	65	—	°C/W
Thermal Resistance Junction to Ambient Air (Note 7)	T _A = +25°C R _{θJA}	45	—	°C/W
Operating Temperature Range	T _J	-65 to +150		°C
Storage Temperature Range	T _{STG}	-65 to +150		°C

Electrical Characteristics (@T_A = +25°C, unless otherwise specified.)

Characteristic	Symbol	Value	Unit	Test Condition
Minimum Reverse Breakdown Voltage (Note 8)	V _{(BR)R}	200	V	I _R = 5μA
Maximum Forward Voltage (Per element)	V _{FM}	1.00 0.96 1.20 1.13	V	I _F = 3A, T _S = +25°C I _F = 3A, T _S = +125°C I _F = 6A, T _S = +25°C I _F = 6A, T _S = +125°C
Maximum Reverse Leakage Current (Per element) (Note 8)	I _{RM}	5 250	μA	T _S = +25°C, V _R = 200V T _S = +125°C, V _R = 200V
Maximum Reverse Recovery Time	t _{RR}	25	ns	I _F = 0.5A, I _R = 1.0A I _{RR} = 0.25A (See Figure 7)

- Notes:
5. FR-4 PCB, 2 oz. Copper, minimum recommended pad layout per <http://www.diodes.com/package-outlines.html>.
 6. Polyimide PCB, 2oz. Copper, minimum recommended pad layout per <http://www.diodes.com/package-outlines.html>.
 7. Polyimide PCB, 2oz. Copper. Cathode pad dimensions 9.4mm x 7.2mm. Anode pad dimensions 2.7mm x 1.6mm.
 8. Short duration pulse test used to minimize self-heating effect.

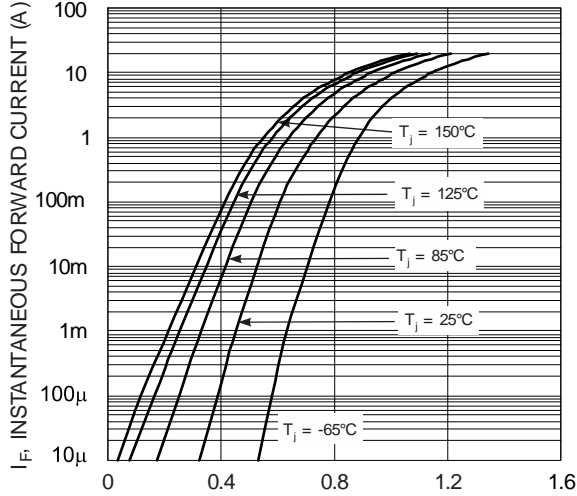

V_F , INSTANTANEOUS FORWARD VOLTAGE (V)
Fig. 1 Typical Forward Characteristics, per element

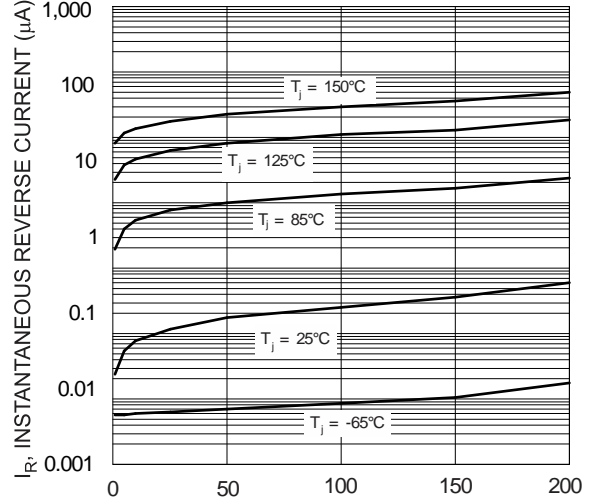

V_R , INSTANTANEOUS REVERSE VOLTAGE (V)
Fig. 2 Typical Reverse Characteristics

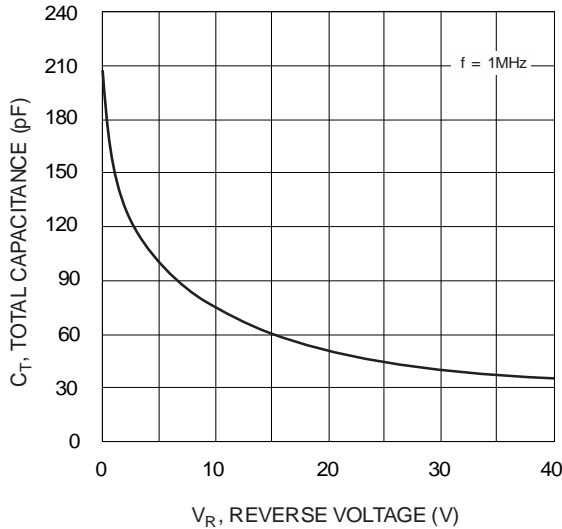

V_R , REVERSE VOLTAGE (V)
Fig. 3 Typical Total Capacitance vs. Reverse Voltage, per element

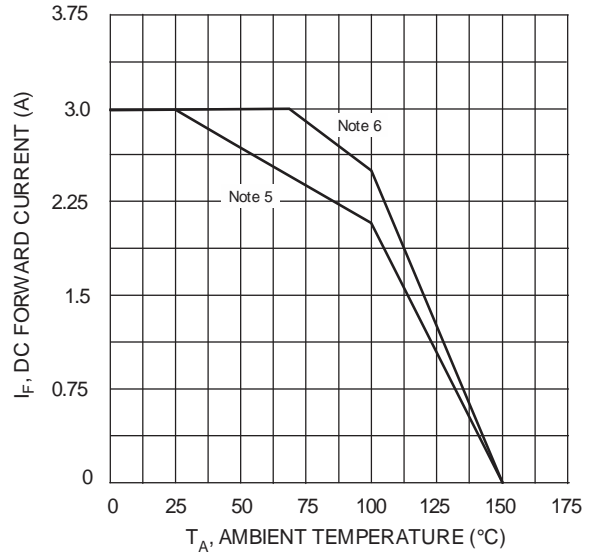

T_A , AMBIENT TEMPERATURE (°C)
Fig. 4 DC Forward Current Derating, per element

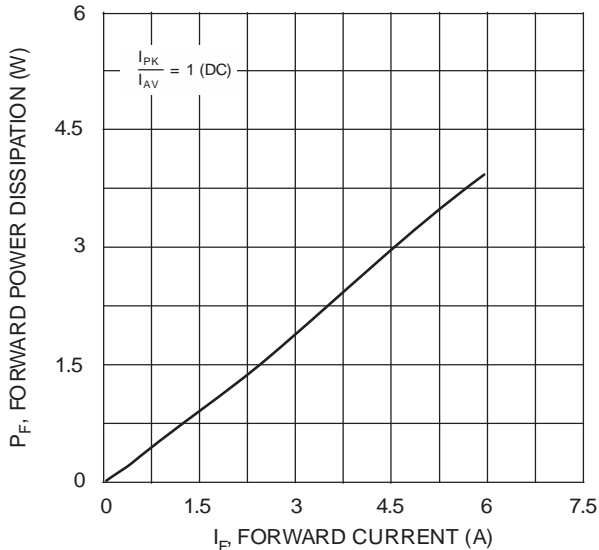

I_F , FORWARD CURRENT (A)
Fig. 5 Forward Power Dissipation, per element

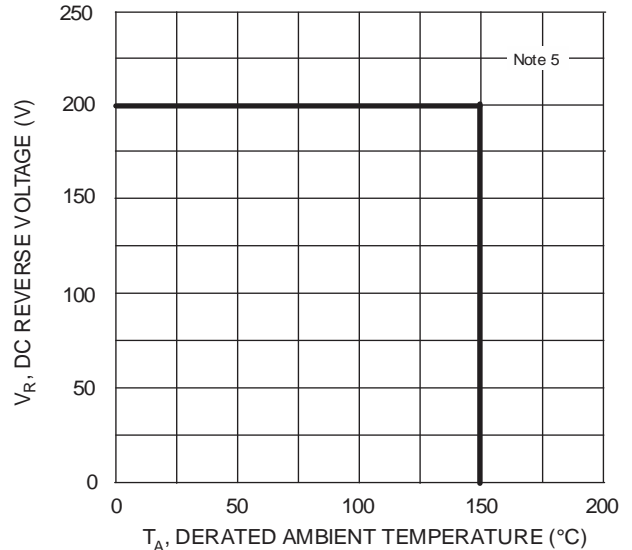

T_A , DERATED AMBIENT TEMPERATURE (°C)
Fig. 6 Operating Temperature Derating

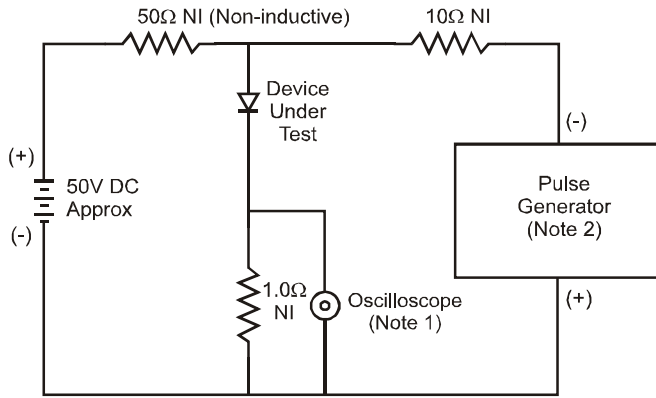

Notes:

1. Rise Time = 7.0ns max. Input Impedance = 1.0MΩ, 22pF.
2. Rise Time = 10ns max. Input Impedance = 50Ω.

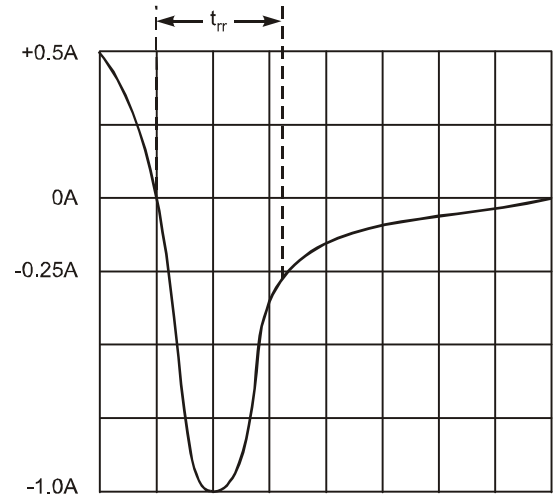

Set time base for 50/100 ns/cm

Fig. 7 Reverse Recovery Time Characteristic and Test Circuit

Package Outline Dimensions

Please see <http://www.diodes.com/package-outlines.html> for the latest version.

PowerDI5

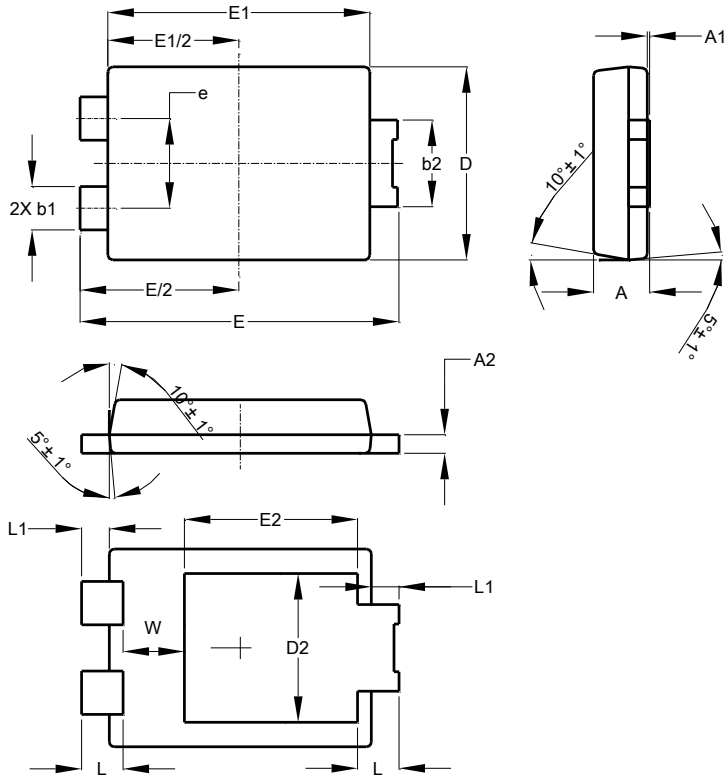

PowerDI5			
Dim	Min	Max	Typ
A	1.05	1.15	1.10
A1	0.00	0.05	--
A2	0.33	0.43	0.381
b1	0.80	0.99	0.89
b2	1.70	1.88	1.78
D	3.90	4.05	3.966
D2	--	--	3.054
E	6.40	6.60	6.504
e	--	--	1.84
E1	5.30	5.45	5.37
E2	--	--	3.549
L	0.75	0.95	0.85
L1	0.50	0.65	0.57
W	1.10	1.41	1.255

All Dimensions in mm

Suggested Pad Layout

Please see <http://www.diodes.com/package-outlines.html> for the latest version.

PowerDI5

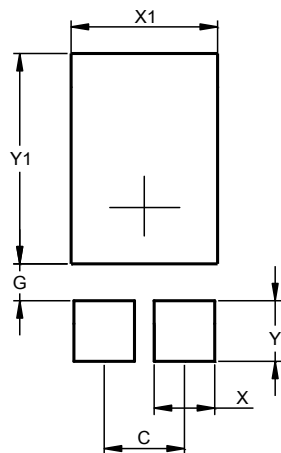

Dimensions	Value (in mm)
C	1.840
G	0.852
X	1.390
X1	3.360
Y	1.400
Y1	4.860

IMPORTANT NOTICE

DIODES INCORPORATED MAKES NO WARRANTY OF ANY KIND, EXPRESS OR IMPLIED, WITH REGARDS TO THIS DOCUMENT, INCLUDING, BUT NOT LIMITED TO, THE IMPLIED WARRANTIES OF MERCHANTABILITY AND FITNESS FOR A PARTICULAR PURPOSE (AND THEIR EQUIVALENTS UNDER THE LAWS OF ANY JURISDICTION).

Diodes Incorporated and its subsidiaries reserve the right to make modifications, enhancements, improvements, corrections or other changes without further notice to this document and any product described herein. Diodes Incorporated does not assume any liability arising out of the application or use of this document or any product described herein; neither does Diodes Incorporated convey any license under its patent or trademark rights, nor the rights of others. Any Customer or user of this document or products described herein in such applications shall assume all risks of such use and will agree to hold Diodes Incorporated and all the companies whose products are represented on Diodes Incorporated website, harmless against all damages.

Diodes Incorporated does not warrant or accept any liability whatsoever in respect of any products purchased through unauthorized sales channel. Should Customers purchase or use Diodes Incorporated products for any unintended or unauthorized application, Customers shall indemnify and hold Diodes Incorporated and its representatives harmless against all claims, damages, expenses, and attorney fees arising out of, directly or indirectly, any claim of personal injury or death associated with such unintended or unauthorized application.

Products described herein may be covered by one or more United States, international or foreign patents pending. Product names and markings noted herein may also be covered by one or more United States, international or foreign trademarks.

This document is written in English but may be translated into multiple languages for reference. Only the English version of this document is the final and determinative format released by Diodes Incorporated.

LIFE SUPPORT

Diodes Incorporated products are specifically not authorized for use as critical components in life support devices or systems without the express written approval of the Chief Executive Officer of Diodes Incorporated. As used herein:

A. Life support devices or systems are devices or systems which:

1. are intended to implant into the body, or
2. support or sustain life and whose failure to perform when properly used in accordance with instructions for use provided in the labeling can be reasonably expected to result in significant injury to the user.

B. A critical component is any component in a life support device or system whose failure to perform can be reasonably expected to cause the failure of the life support device or to affect its safety or effectiveness.

Customers represent that they have all necessary expertise in the safety and regulatory ramifications of their life support devices or systems, and acknowledge and agree that they are solely responsible for all legal, regulatory and safety-related requirements concerning their products and any use of Diodes Incorporated products in such safety-critical, life support devices or systems, notwithstanding any devices- or systems-related information or support that may be provided by Diodes Incorporated. Further, Customers must fully indemnify Diodes Incorporated and its representatives against any damages arising out of the use of Diodes Incorporated products in such safety-critical, life support devices or systems.

Copyright © 2016, Diodes Incorporated

www.diodes.com