

**QUAD SURFACE MOUNT SWITCHING DIODE ARRAY**

**Features**

- Fast Switching Speed
- Low Forward Voltage: Maximum of 0.715V at 1mA
- Fast Reverse Recovery: Maximum of 4ns
- Low Capacitance: Maximum of 2pF
- Small Surface Mount Package
- For General Purpose Switching Applications
- Two "BAV99" Circuits In One Package
- Easily Connected As Full-Wave Bridge
- **Totally Lead-Free & Fully RoHS Compliant (Notes 1 & 2)**
- **Halogen and Antimony Free. "Green" Device (Note 3)**

**Mechanical Data**

- Case: SOT-363
- Case Material: Molded Plastic, "Green" Molding Compound. UL Flammability Classification Rating 94V-0
- Moisture Sensitivity: Level 1 per J-STD-020D
- Terminals: Solderable per MIL-STD-202, Method 208
- Lead Free Plating (Matte Tin Finish annealed over Alloy 42 leadframe). **(e3)**
- Polarity: See Diagram
- Weight: 0.006 grams (approximate)

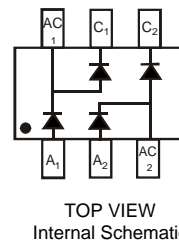

**Ordering Information** (Note 4)

Part Number	Case	Packaging
BAV99BRW-7-F	SOT-363	3000/Tape & Reel

- Notes:
1. No purposely added lead. Fully EU Directive 2002/95/EC (RoHS) & 2011/65/EU (RoHS 2) compliant.
  2. See <http://www.diodes.com> for more information about Diodes Incorporated's definitions of Halogen- and Antimony-free, "Green" and Lead-free.
  3. Halogen- and Antimony-free "Green" products are defined as those which contain <900ppm bromine, <900ppm chlorine (<1500ppm total Br + Cl) and <1000ppm antimony compounds.
  4. For packaging details, go to our website at <http://www.diodes.com/datasheets/ap02007.pdf>.

**Marking Information**

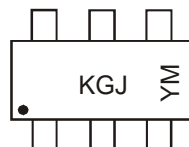

KGJ = Product Type Marking Code  
 YM = Date Code Marking  
 Y = Year ex: Z = 2012  
 M = Month ex: 9 = September

Date Code Key

Year	2001	2002	2003	.....	.....	2012	2013	2014	2015	2016	2017	2018
Code	M	N	P	.....	.....	Z	A	B	C	D	E	F

Month	Jan	Feb	Mar	Apr	May	Jun	Jul	Aug	Sep	Oct	Nov	Dec
Code	1	2	3	4	5	6	7	8	9	O	N	D

**Maximum Ratings** (@ $T_A = +25^\circ\text{C}$ , unless otherwise specified.)

Characteristic	Symbol	Value	Unit
Non-Repetitive Peak Reverse Voltage	$V_{RM}$	100	V
Peak Repetitive Reverse Voltage	$V_{RRM}$	75	V
Working Peak Reverse Voltage	$V_{RWM}$		
DC Blocking Voltage	$V_R$		
RMS Reverse Voltage	$V_{R(RMS)}$	53	V
Forward Continuous Current (Note 5)	$I_{FM}$	300	mA
Average Rectified Output Current (Note 5)	$I_O$	150	mA
Non-Repetitive Peak Forward Surge Current		@ $t = 1.0\mu\text{s}$	2.0
		@ $t = 1.0\text{s}$	1.0

**Thermal Characteristics**

Characteristic	Symbol	Value	Unit
Power Dissipation (Note 5)	$P_D$	200	mW
Thermal Resistance Junction to Ambient Air (Note 5)	$R_{\theta JA}$	625	$^\circ\text{C/W}$
Operating and Storage Temperature Range	$T_J, T_{STG}$	-65 to +150	$^\circ\text{C}$

**Electrical Characteristics** (@ $T_A = +25^\circ\text{C}$ , unless otherwise specified.)

Characteristic	Symbol	Min	Max	Unit	Test Condition
Reverse Breakdown Voltage (Note 6)	$V_{(BR)R}$	75	—	V	$I_R = 2.5\mu\text{A}$
Forward Voltage	$V_F$	—	0.715	V	$I_F = 1.0\text{mA}$
			0.855		$I_F = 10\text{mA}$
			1.0		$I_F = 50\text{mA}$
			1.25		$I_F = 150\text{mA}$
Reverse Current (Note 6)	$I_R$	—	2.5	$\mu\text{A}$	$V_R = 75\text{V}$
			50	$\mu\text{A}$	$V_R = 75\text{V}, T_J = +150^\circ\text{C}$
			30	$\mu\text{A}$	$V_R = 25\text{V}, T_J = +150^\circ\text{C}$
			25	nA	$V_R = 20\text{V}$
Total Capacitance	$C_T$	—	2.0	pF	$V_R = 0, f = 1.0\text{MHz}$
Reverse Recovery Time	$t_{rr}$	—	4.0	ns	$I_F = I_R = 10\text{mA}, I_{rr} = 0.1 \times I_R, R_L = 100\Omega$

- Notes:
- Device mounted on FR-4 PC board with recommended pad layout, which can be found on our website at <http://www.diodes.com/datasheets/ap02001.pdf>.
  - Short duration pulse test used to minimize self-heating effect.

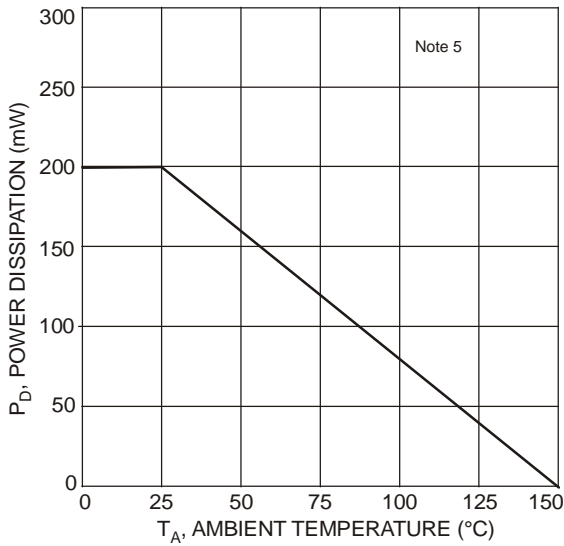

Figure 1 Power Derating Curve, Total Package

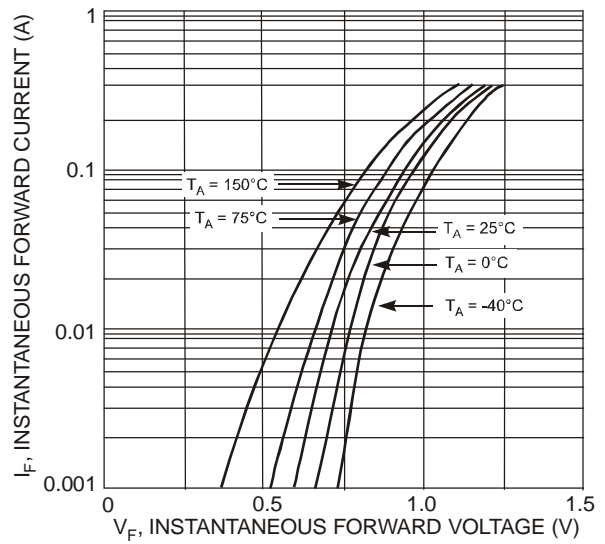

Figure 2 Typical Forward Characteristics, Per Element

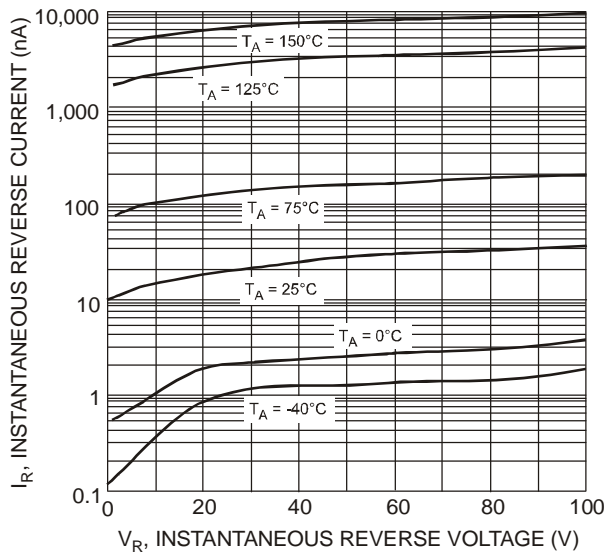

Figure 3 Typical Reverse Characteristics, Per Element

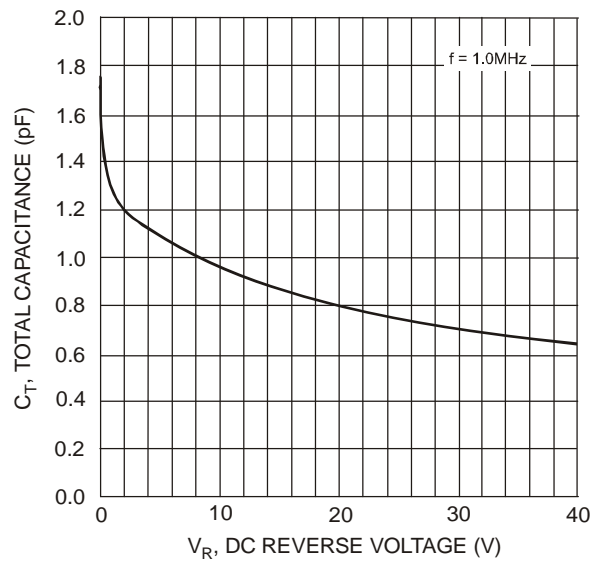
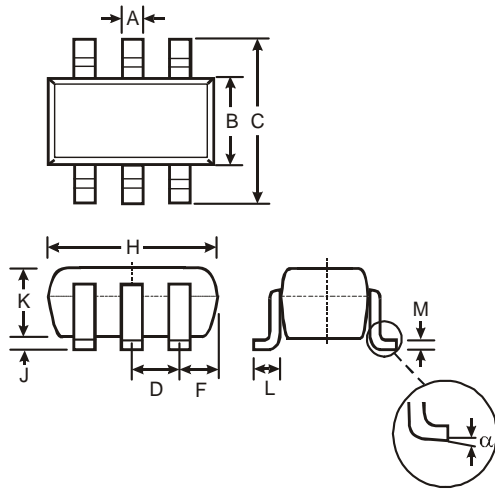

Figure 4 Total Capacitance vs. Reverse Voltage, Per Element

**Package Outline Dimensions**



SOT363			
Dim	Min	Max	Typ
A	0.10	0.30	0.25
B	1.15	1.35	1.30
C	2.00	2.20	2.10
D	0.65 Typ		
F	0.40	0.45	0.425
H	1.80	2.20	2.15
J	0	0.10	0.05
K	0.90	1.00	1.00
L	0.25	0.40	0.30
M	0.10	0.22	0.11
α	0°	8°	-
All Dimensions in mm			

**Suggested Pad Layout**

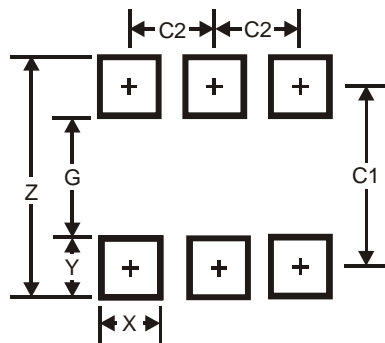

Dimensions	Value (in mm)
Z	2.5
G	1.3
X	0.42
Y	0.6
C1	1.9
C2	0.65

**IMPORTANT NOTICE**

DIODES INCORPORATED MAKES NO WARRANTY OF ANY KIND, EXPRESS OR IMPLIED, WITH REGARDS TO THIS DOCUMENT, INCLUDING, BUT NOT LIMITED TO, THE IMPLIED WARRANTIES OF MERCHANTABILITY AND FITNESS FOR A PARTICULAR PURPOSE (AND THEIR EQUIVALENTS UNDER THE LAWS OF ANY JURISDICTION).

Diodes Incorporated and its subsidiaries reserve the right to make modifications, enhancements, improvements, corrections or other changes without further notice to this document and any product described herein. Diodes Incorporated does not assume any liability arising out of the application or use of this document or any product described herein; neither does Diodes Incorporated convey any license under its patent or trademark rights, nor the rights of others. Any Customer or user of this document or products described herein in such applications shall assume all risks of such use and will agree to hold Diodes Incorporated and all the companies whose products are represented on Diodes Incorporated website, harmless against all damages.

Diodes Incorporated does not warrant or accept any liability whatsoever in respect of any products purchased through unauthorized sales channel. Should Customers purchase or use Diodes Incorporated products for any unintended or unauthorized application, Customers shall indemnify and hold Diodes Incorporated and its representatives harmless against all claims, damages, expenses, and attorney fees arising out of, directly or indirectly, any claim of personal injury or death associated with such unintended or unauthorized application.

Products described herein may be covered by one or more United States, international or foreign patents pending. Product names and markings noted herein may also be covered by one or more United States, international or foreign trademarks.

**LIFE SUPPORT**

Diodes Incorporated products are specifically not authorized for use as critical components in life support devices or systems without the express written approval of the Chief Executive Officer of Diodes Incorporated. As used herein:

A. Life support devices or systems are devices or systems which:

1. are intended to implant into the body, or
2. support or sustain life and whose failure to perform when properly used in accordance with instructions for use provided in the labeling can be reasonably expected to result in significant injury to the user.

B. A critical component is any component in a life support device or system whose failure to perform can be reasonably expected to cause the failure of the life support device or to affect its safety or effectiveness.

Customers represent that they have all necessary expertise in the safety and regulatory ramifications of their life support devices or systems, and acknowledge and agree that they are solely responsible for all legal, regulatory and safety-related requirements concerning their products and any use of Diodes Incorporated products in such safety-critical, life support devices or systems, notwithstanding any devices- or systems-related information or support that may be provided by Diodes Incorporated. Further, Customers must fully indemnify Diodes Incorporated and its representatives against any damages arising out of the use of Diodes Incorporated products in such safety-critical, life support devices or systems.

Copyright © 2012, Diodes Incorporated

[www.diodes.com](http://www.diodes.com)