

Features

- Ultra-Small Surface Mount Package
- Ideally suited for Automated Assembly Processes
- Very Sharp Breakdown Characteristics
- Very Tight Tolerance on Zener Breakdown Voltage
- **Lead, Halogen and Antimony Free, RoHS Compliant**
- **"Green" Device (Notes 4 and 5)**

Mechanical Data

- Case: SOD-323
- Case Material: UL Flammability Classification Rating 94V-0
- Moisture Sensitivity: Level 1 per J-STD-020D
- Terminal Connections: Cathode Band
- Terminals: Finish - Matte Tin annealed over Alloy 42 leadframe. Solderable per MIL-STD-202, Method 208
- Marking Information: See Page 3
- Ordering Information: See Page 3
- Weight: 0.004 grams (approximate)



Top View

Thermal Characteristics

| Characteristic | Symbol | Value | Unit |
|---|-----------------|-------------|---------------|
| Power Dissipation (Note 1) | P_D | 200 | mW |
| Thermal Resistance Junction to Ambient Air (Note 1) | $R_{\theta JA}$ | 625 | $^{\circ}C/W$ |
| Operating and Storage Temperature Range | T_J, T_{STG} | -65 to +150 | $^{\circ}C$ |

Electrical Characteristics @ $T_A = 25^{\circ}C$ unless otherwise specified

| Type Number | Marking Code | Zener Voltage Range (Note 2) | | | Maximum Zener Impedance (Note 3) | | | Maximum Reverse Current (Note 2) | |
|-------------|--------------|------------------------------|---------|----------|----------------------------------|-------------------|----------|----------------------------------|-------|
| | | $V_{ZT} @ I_{ZT}$ | | I_{ZT} | $Z_{ZT} @ I_{ZT}$ | $Z_{ZK} @ I_{ZK}$ | I_{ZK} | I_R | V_R |
| | | Min (V) | Max (V) | mA | Ω | Ω | mA | μA | V |
| UDZ5V1B | BB | 4.980 | 5.200 | 5 | 80 | 500 | 0.5 | 2 | 1.5 |
| UDZ5V6B | BC | 5.490 | 5.730 | 5 | 60 | 200 | 0.5 | 1 | 2.5 |
| UDZ6V2B | BD | 6.060 | 6.330 | 5 | 60 | 100 | 0.5 | 1 | 3.0 |
| UDZ6V8B | BE | 6.650 | 6.930 | 5 | 40 | 60 | 0.5 | 0.5 | 3.5 |
| UDZ7V5B | BF | 7.280 | 7.600 | 5 | 30 | 60 | 0.5 | 0.5 | 4.0 |
| UDZ8V2B | BG | 8.020 | 8.360 | 5 | 30 | 60 | 0.5 | 0.5 | 5.0 |
| UDZ9V1B | BH | 8.850 | 9.230 | 5 | 30 | 60 | 0.5 | 0.5 | 6.0 |
| UDZ10B | BI | 9.770 | 10.210 | 5 | 30 | 60 | 0.5 | 0.1 | 7.0 |
| UDZ11B | BJ | 10.760 | 11.220 | 5 | 30 | 60 | 0.5 | 0.1 | 8.0 |
| UDZ12B | BK | 11.740 | 12.240 | 5 | 30 | 80 | 0.5 | 0.1 | 9.0 |
| UDZ13B | BL | 12.910 | 13.490 | 5 | 37 | 80 | 0.5 | 0.1 | 10.0 |
| UDZ15B | BM | 14.340 | 14.980 | 5 | 42 | 80 | 0.5 | 0.1 | 11.0 |

- Notes:
1. Part mounted on FR-4 PC board with recommended pad layout, which can be found on our website at <http://www.diodes.com/datasheets/ap02001.pdf>.
 2. Short duration pulse test used to minimize self-heating effect.
 3. The Zener impedances (Z_{ZT}, Z_{ZK}) are measured by superimposing a minute alternating current on the regulated current (I_Z).
 4. No purposefully added lead. Halogen and Antimony Free.
 5. Product manufactured with Data Code V9 (week 33, 2008) and newer are built with Green Molding Compound. Product manufactured prior to Date Code V9 are built with Non-Green Molding Compound and may contain Halogens or Sb_2O_3 Fire Retardants.

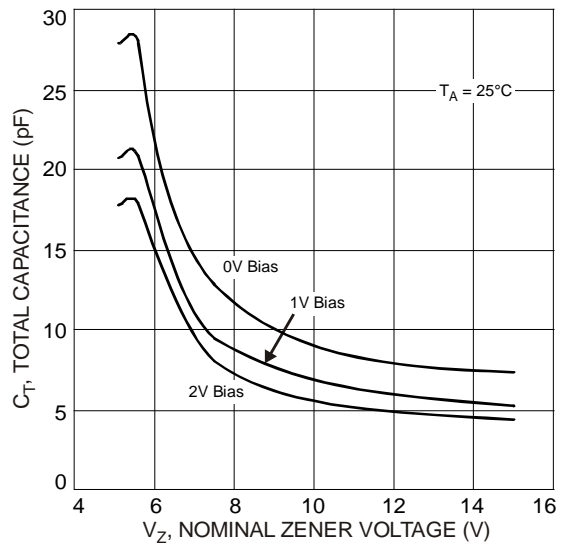
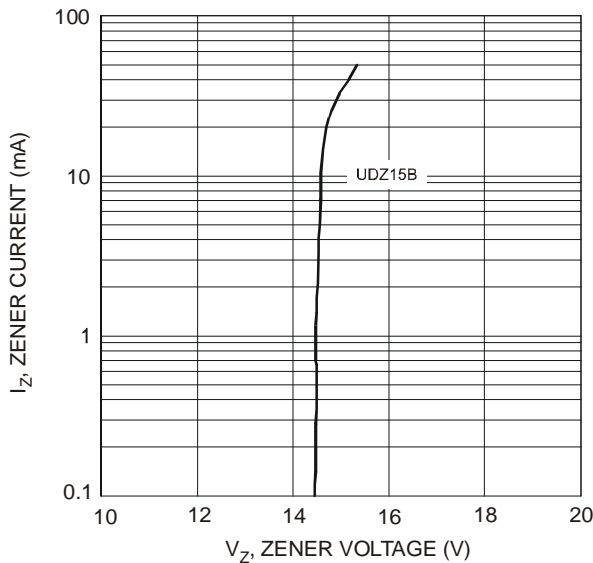
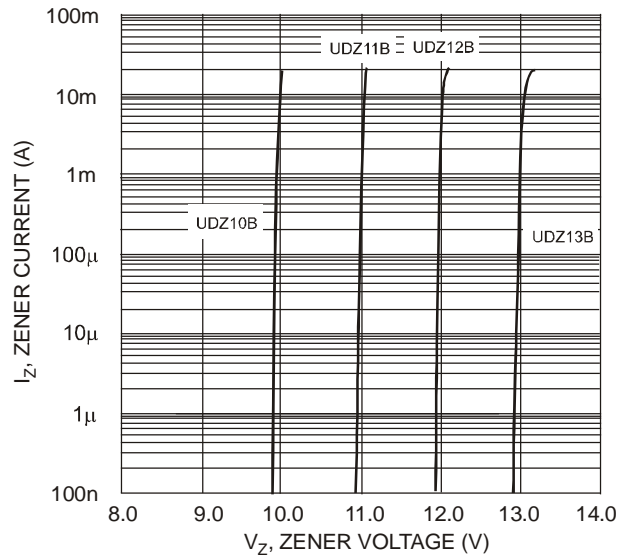
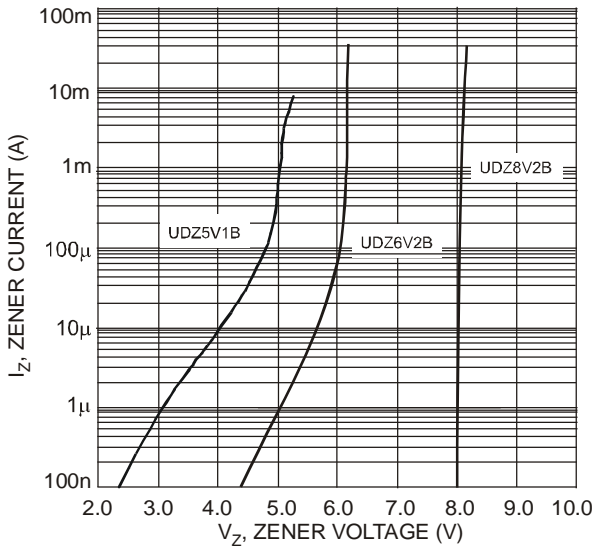
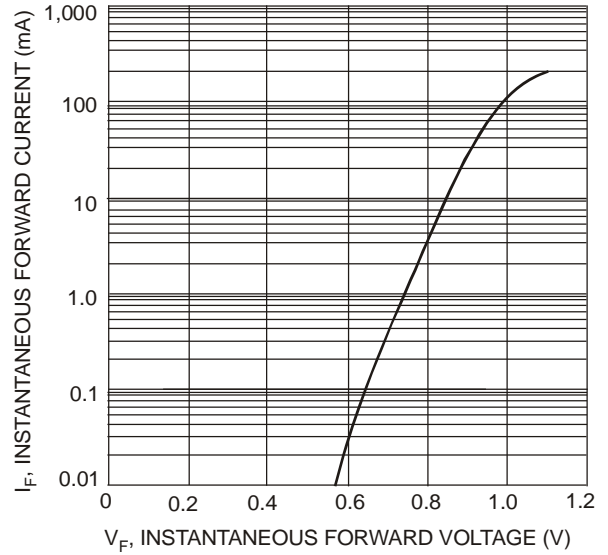
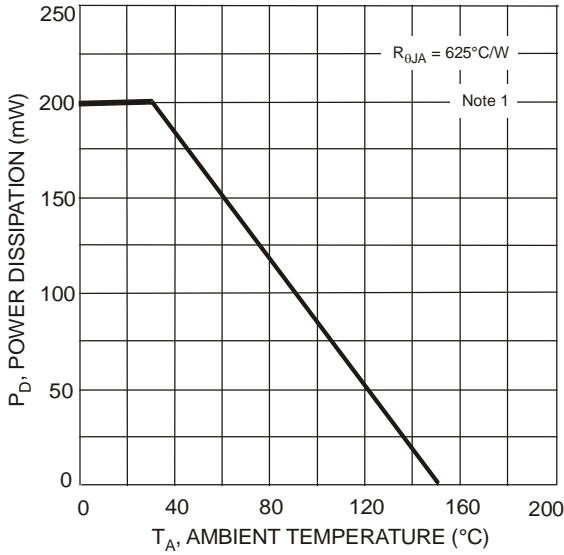

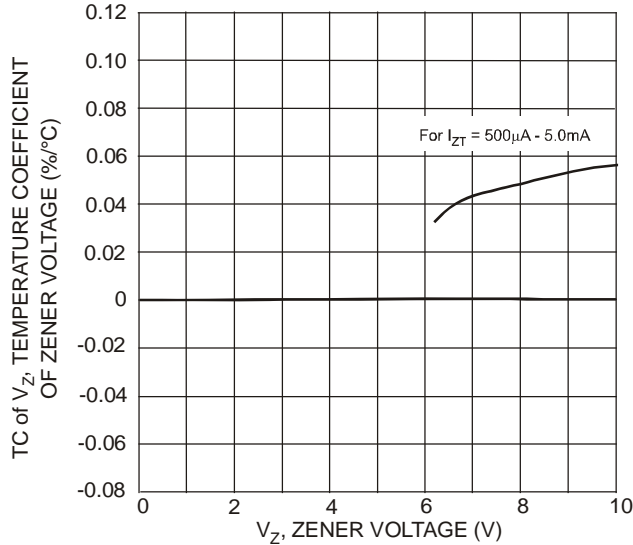

Fig. 7 Typical Temperature Coefficient of Zener Voltage vs. Zener Voltage, UDZ6V2B-UDZ10B

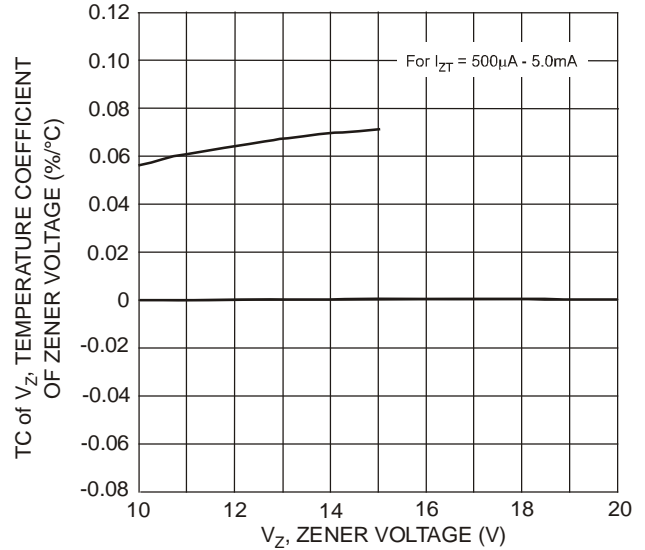

Fig. 8 Typical Temperature Coefficient of Zener Voltage vs. Zener Voltage, UDZ10B-UDZ15B

Ordering Information (Note 6)

| Device | Packaging | Shipping |
|------------------|-----------|------------------|
| (Type Number)-7* | SOD-323 | 3000/Tape & Reel |

* Add "-7" to the appropriate type number in Electrical Characteristics Table from Page 1 example: 6.2V Zener = UDZ6V2B-7.

Notes: 6. For packaging details, go to our website at <http://www.diodes.com/datasheets/ap02007.pdf>.

Marking Information



xx = Product Type Marking Code
(See Electrical Characteristics Table)

Package Outline Dimensions

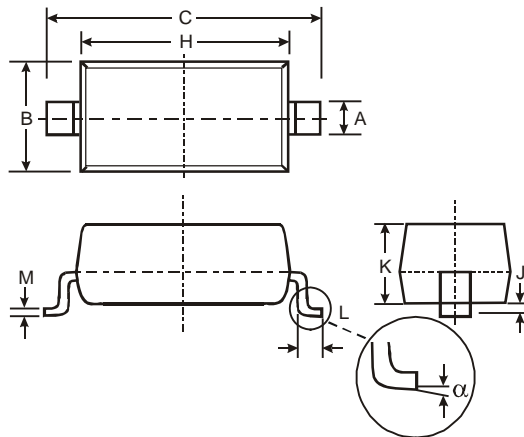

| SOD-323 | | |
|-----------------------------|------|------|
| Dim | Min | Max |
| A | 0.25 | 0.35 |
| B | 1.20 | 1.40 |
| C | 2.30 | 2.70 |
| H | 1.60 | 1.80 |
| J | 0.00 | 0.10 |
| K | 1.0 | 1.1 |
| L | 0.20 | 0.40 |
| M | 0.10 | 0.15 |
| α | 0° | 8° |
| All Dimensions in mm | | |

Suggested Pad Layout

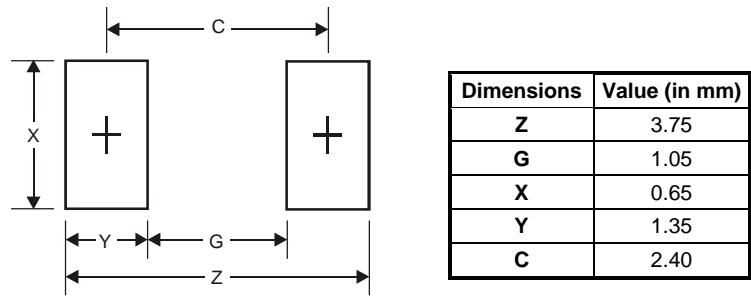

IMPORTANT NOTICE

Diodes Incorporated and its subsidiaries reserve the right to make modifications, enhancements, improvements, corrections or other changes without further notice to any product herein. Diodes Incorporated does not assume any liability arising out of the application or use of any product described herein; neither does it convey any license under its patent rights, nor the rights of others. The user of products in such applications shall assume all risks of such use and will agree to hold Diodes Incorporated and all the companies whose products are represented on our website, harmless against all damages.

LIFE SUPPORT

Diodes Incorporated products are not authorized for use as critical components in life support devices or systems without the expressed written approval of the President of Diodes Incorporated.