

## Description

The AZ2185 series is low dropout positive voltage regulators with a maximum dropout of 1.5V at 3A of load current.

The device features low quiescent current, low adjustable current and improved load transient performance. This device built in band-gap reference circuit, on-chip thermal shutdown and current limit function.

The AZ2185 is available in adjustable version. The adjustable version can set the output voltage with two external resistors.

The AZ2185 series is available in standard packages of TO252 (Standard).

## Features

- Low Dropout Voltage: Typical 1.3V at 3A
- Current Limiting and Thermal Protection
- Output Current: 3A
- Current Limit: 4.5A
- Operating Junction Temperature: -40 to +125°C
- Line Regulation: 0.015%/V (Typ)
- Load Regulation: 0.1%/A (Typ)
- Adjust Pin Current: 6µA (Typ)
- Minimum Load Current: 0.3mA (Typ)
- Compatible with Low ESR Ceramic Capacitor
- **Totally Lead-Free & Fully RoHS Compliant (Notes 1 & 2)**
- **Halogen and Antimony Free. "Green" Device (Note 3)**

## Applications

- High Efficiency Linear Regulators
- Battery Charger
- Digital Video/Camcorder
- Post Regulation for Switching Supplies
- Microprocessor Supply
- Mother Board Power Supplies
- DVD-video Player
- Telecom Equipment
- Set Top Boxes and Web Boxes Modules' Supply

## Features

(Top View)

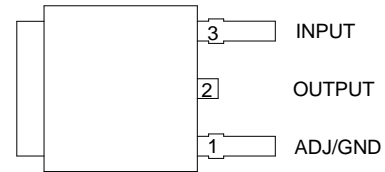

TO252 (Standard)

## Applications

- High Efficiency Linear Regulators
- Battery Charger
- Digital Video/Camcorder
- Post Regulation for Switching Supplies
- Microprocessor Supply
- Mother Board Power Supplies
- DVD-video Player
- Telecom Equipment
- Set Top Boxes and Web Boxes Modules' Supply

- Notes:
1. No purposely added lead. Fully EU Directive 2002/95/EC (RoHS) & 2011/65/EU (RoHS 2) compliant.
  2. See [http://www.diodes.com/quality/lead\\_free.html](http://www.diodes.com/quality/lead_free.html) for more information about Diodes Incorporated's definitions of Halogen- and Antimony-free, "Green" and Lead-free.
  3. Halogen- and Antimony-free "Green" products are defined as those which contain <900ppm bromine, <900ppm chlorine (<1500ppm total Br + Cl) and <1000ppm antimony compounds.

**Typical Applications Circuit** (Note 4)

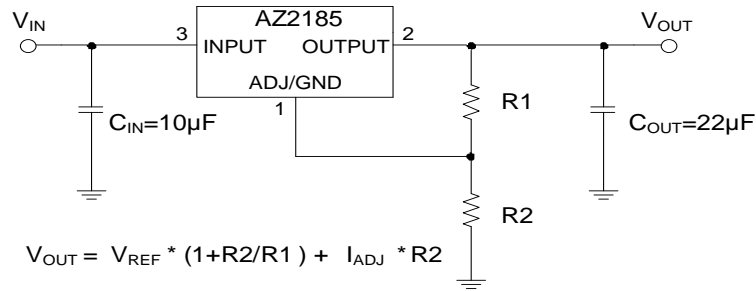

Note 4: The AZ2185 is compatible with low ESR ceramic capacitor.  
The ESR of the output capacitors must be less than 0.4Ω.  
A minimum of 10µF output capacitor is required.

**Pin Descriptions**

Pin Number	Pin Name	Function
1	ADJ/GND	Adjust pin/Ground
2	OUTPUT	Output voltage
3	INPUT	Input voltage

**Functional Block Diagram**

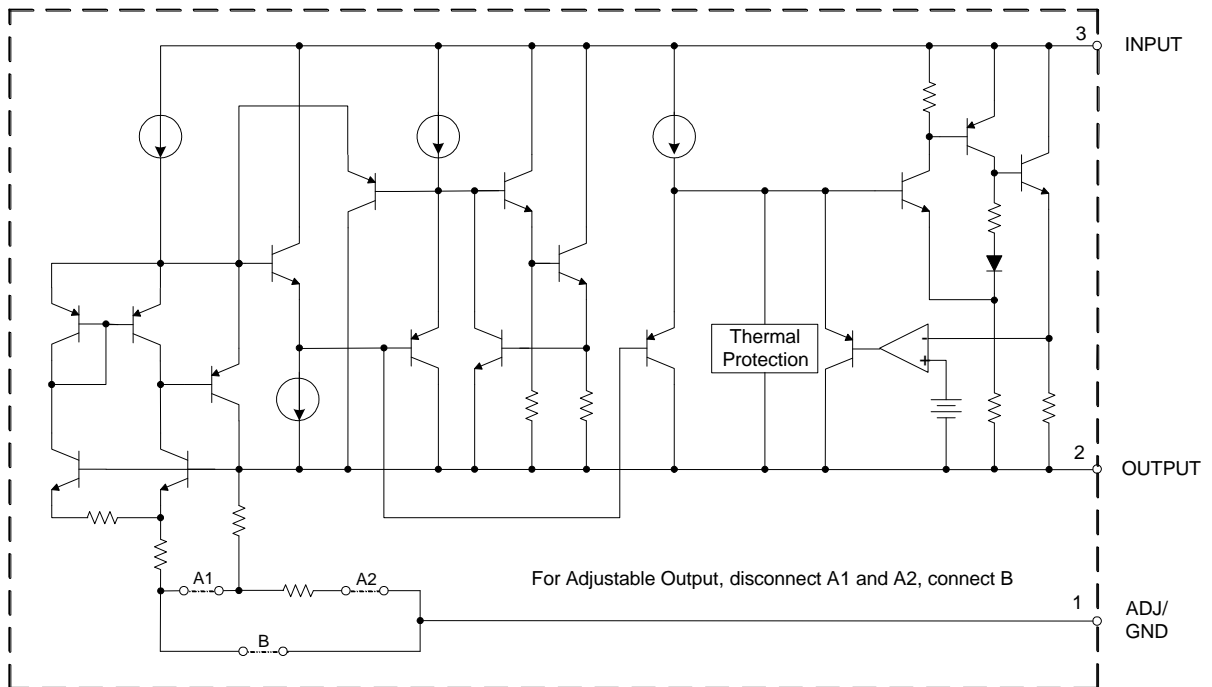

### Absolute Maximum Ratings (Note 5)

Symbol	Parameter	Rating	Unit
$V_{IN}$	Input Voltage	18	V
$T_J$	Operating Junction Temperature	+150	°C
$T_{STG}$	Storage Temperature Range	-65 to +150	°C
$T_{LEAD}$	Lead Temperature (Soldering, 10sec)	+260	°C
$\theta_{JA}$	Thermal Resistance (Junction to Ambient)	75	°C/W
—	ESD (Human Body Model)	5000	V
—	ESD (Charge Device Model)	2000	V

Note 5: Stresses greater than those listed under “Absolute Maximum Ratings” may cause permanent damage to the device. These are stress ratings only, and functional operation of the device at these or any other conditions beyond those indicated under “Recommended Operating Conditions” is not implied. Exposure to “Absolute Maximum Ratings” for extended periods may affect device reliability.

### Recommended Operating Conditions

Symbol	Parameter	Min	Max	Unit
$V_{IN}$	Input Voltage	—	12	V
$T_J$	Operating Junction Temperature	-40	+125	°C

**Electrical Characteristics** (Typicals and limits appearing in normal type apply for  $T_J = +25^\circ\text{C}$ . Limits appearing in **Boldface** type apply over the entire operating junction temperature range  $-40$  to  $+125^\circ\text{C}$ .)

Symbol	Parameter	Conditions	Min	Typ	Max	Unit
$V_{REF}$	Reference Voltage	$I_{OUT} = 10\text{mA}$ , $V_{IN}-V_{OUT} = 3\text{V}$ , $T_J = +25^\circ\text{C}$ , $10\text{mA} \leq I_{OUT} \leq 3\text{A}$ , $1.5\text{V} \leq V_{IN}-V_{OUT} \leq 5\text{V}$	1.238 <b>1.225</b>	1.250 <b>1.250</b>	1.262 <b>1.275</b>	V
$V_{RLOAD}$	Load Regulation	$10\text{mA} \leq I_{OUT} \leq 3\text{A}$ , $V_{IN}-V_{OUT} = 3\text{V}$	—	0.1 <b>0.2</b>	0.4 <b>0.5</b>	%/A
$V_{RLINE}$	Line Regulation	$I_{OUT} = 10\text{mA}$ , $2.85\text{V} \leq V_{IN} \leq 10\text{V}$	—	0.015 <b>0.035</b>	0.2 <b>0.2</b>	%/V
$V_{DROP}$	Dropout Voltage	$I_{OUT} = 3\text{A}$ , $\Delta V_{REF}$ , $\Delta V_{OUT} = 1\%$	—	<b>1.3</b>	<b>1.5</b>	V
$I_{LIMIT}$ (Note 6)	Current Limit	$V_{IN}-V_{OUT} = 3\text{V}$	3.2	4.5	4.95	A
$I_{LOAD}$	Minimum Load Current	$V_{IN} = 10\text{V}$	—	0.3	1	mA
$I_{ADJ}$	Adjust Pin Current	$V_{IN} = 4.25\text{V}$ , $I_{OUT} = 10\text{mA}$	—	6	10	$\mu\text{A}$
$\Delta I_{ADJ}$	Adjust Pin Current Change	$10\text{mA} \leq I_{OUT} \leq 3\text{A}$ , $1.5\text{V} \leq V_{IN}-V_{OUT} \leq 6\text{V}$	—	0.3	2	$\mu\text{A}$
PSRR	Ripple Rejection	$f_{RIPPLE} = 120\text{Hz}$ , $C_{OUT} = 22\mu\text{F}$ , $I_{OUT} = 3\text{A}$ , $V_{IN}-V_{OUT} = 3\text{V}$	—	50	—	dB
—	Long Term Stability	$T_A = +125^\circ\text{C}$ , 1000Hrs	—	0.5	—	%
—	Temperature Stability	$I_{OUT} = 10\text{mA}$ , $V_{IN}-V_{OUT} = 1.5\text{V}$	—	50	—	PPM%
—	RMS Noise (% of $V_{OUT}$ )	$T_A = +125^\circ\text{C}$ , $10\text{Hz} \leq f \leq 10\text{kHz}$	—	0.003	—	%
—	OTSD	—	—	+150	—	$^\circ\text{C}$
—	OTSD Hysteresis	—	—	+20	—	$^\circ\text{C}$
$\theta_{JC}$	Thermal Resistance (Junction to Case)	—	—	10	—	$^\circ\text{C/W}$

Note 6: Make the  $V_{OUT}$  down to about 98% of the test values,  $I_{OUT}$  value is set to  $I_{LIMIT}$  at this time.

**Performance Characteristics**

NEW PRODUCT

**Line Regulation vs. Temperature**

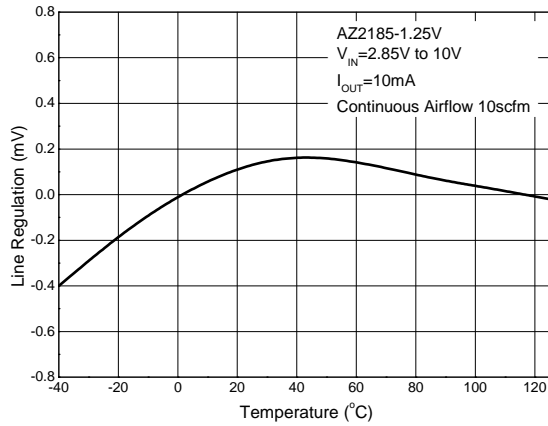

**Load Regulation vs. Temperature**

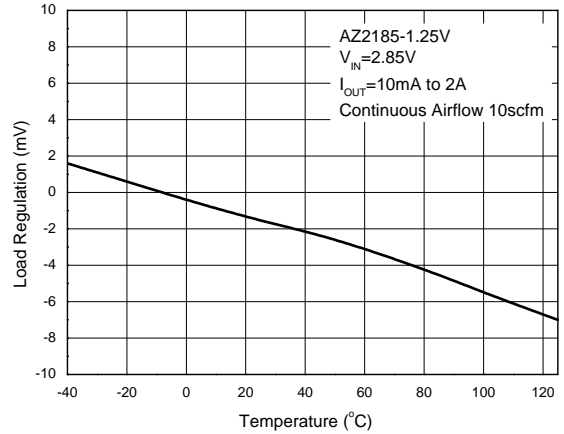

**Reference Voltage vs. Temperature**

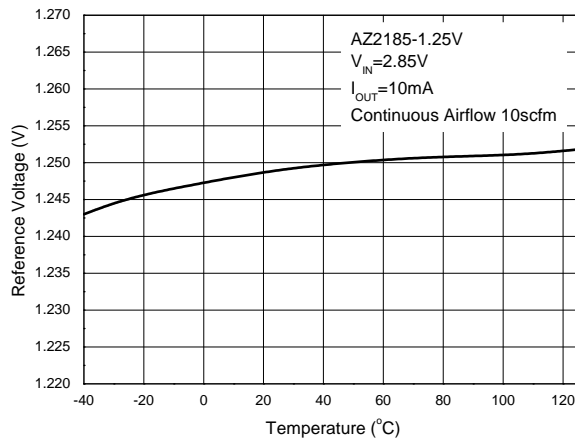

**Current Limit vs. Temperature**

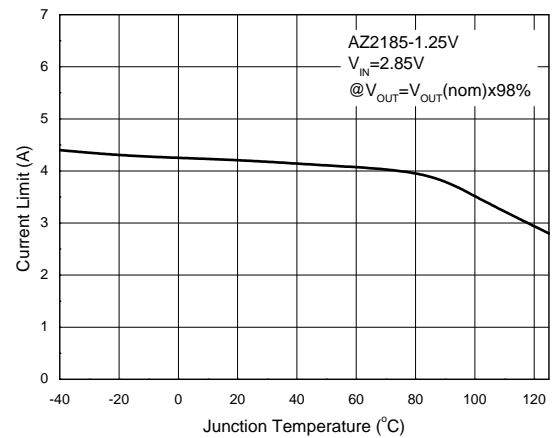

**Minimum Load Current vs. Temperature**

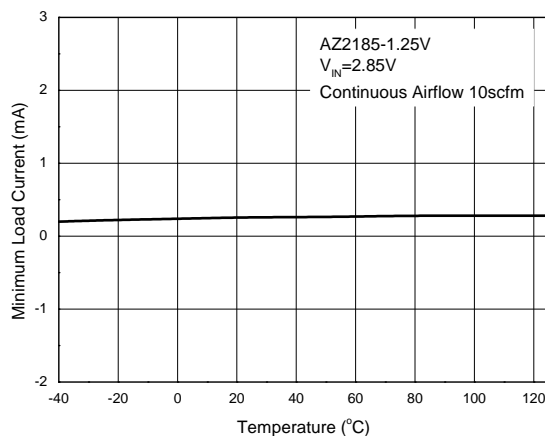

**Adjust Pin Current vs. Temperature**

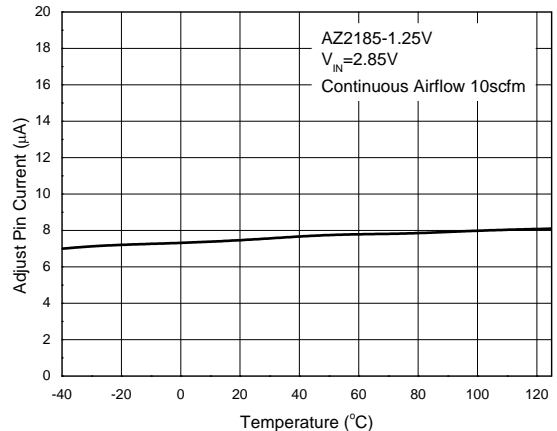

**Performance Characteristics (Cont.)**

**Dropout Voltage vs. Output Current**

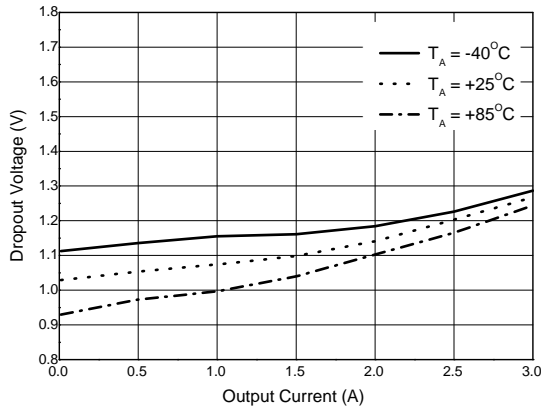

**Dropout Voltage vs. Temperature**

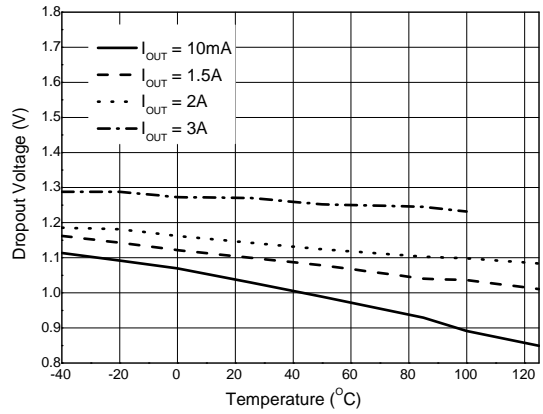

**PSRR vs. Frequency**

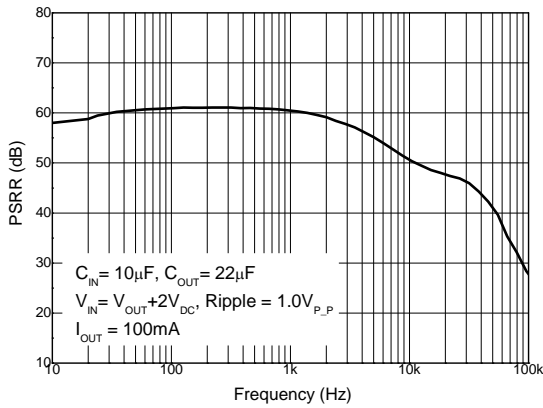

**Load Transient Response**

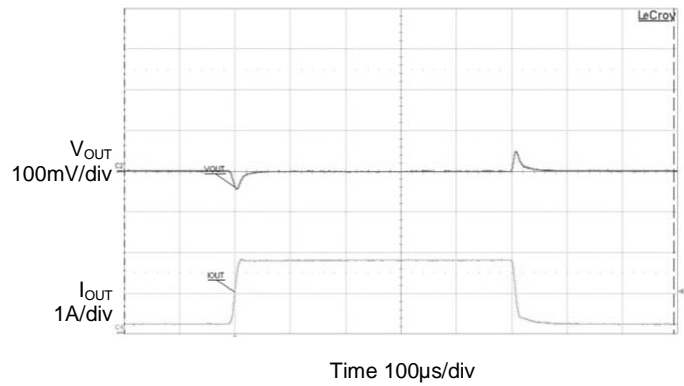

**Power Dissipation vs. Temperature**

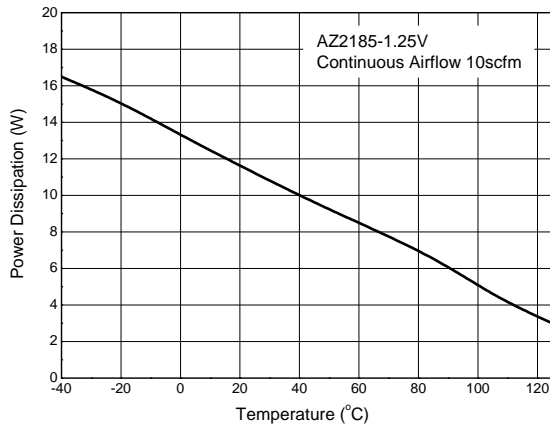

NEW PRODUCT

**Ordering Information**

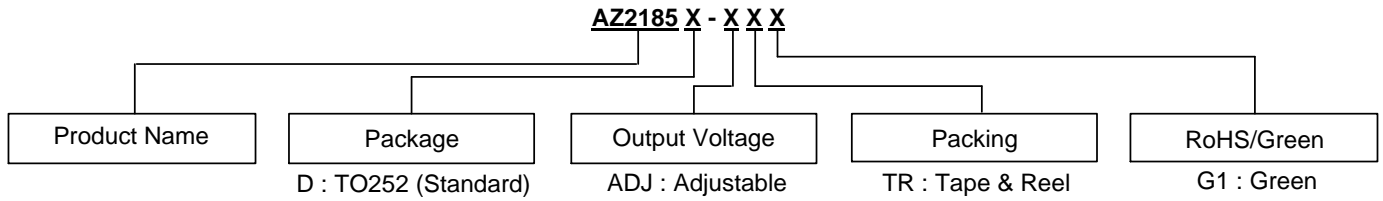

Package	Temperature Range	Part Number	Marking ID	Packing
TO252 (Standard)	-40 to +125°C	AZ2185D-ADJTRG1	AZ2185D-ADJG1	2500/Tape & Reel

NEW PRODUCT

**Marking Information**

(1) TO252 (Standard)

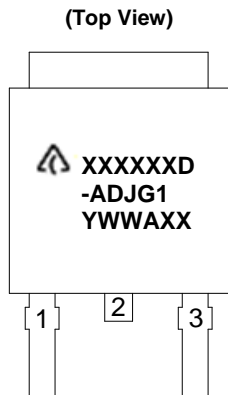

First and Second Lines: Logo and Marking ID (See Ordering Information)  
 Third Line: Date Code  
 Y: Year  
 WW: Work Week of Molding  
 A: Assembly House Code  
 XX: 7<sup>th</sup> and 8<sup>th</sup> Digits of Batch Number

## Package Outline Dimensions

Please see <http://www.diodes.com/package-outlines.html> for the latest version.

### (1) Package Type: TO252 (Standard)

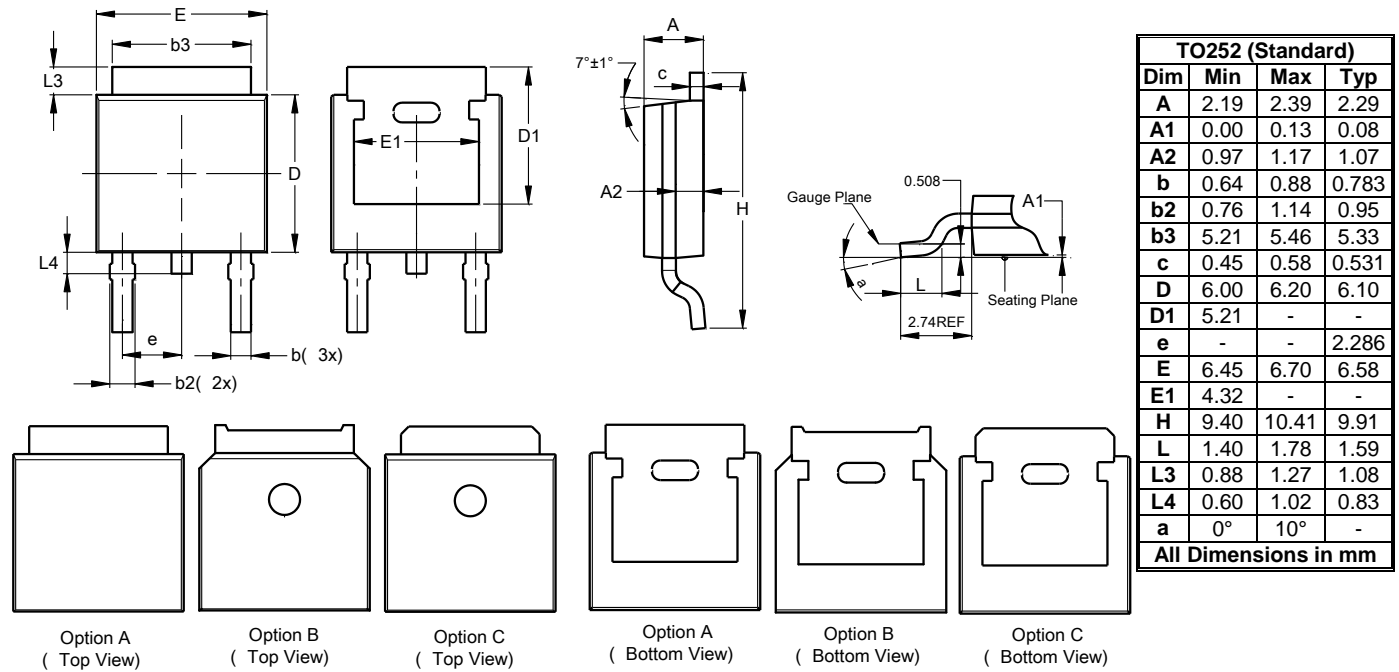

## Suggested Pad Layout

Please see <http://www.diodes.com/package-outlines.html> for the latest version.

### (1) Package Type: TO252 (Standard)

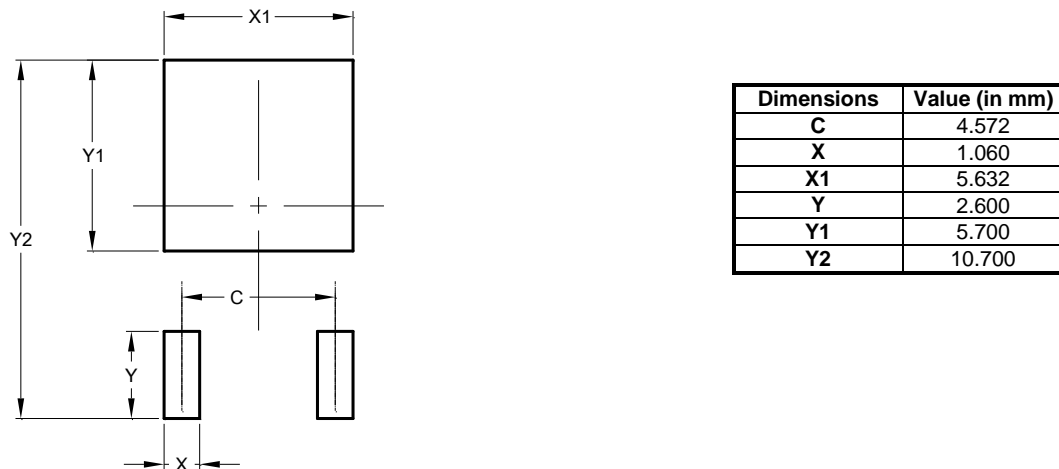



**IMPORTANT NOTICE**

DIODES INCORPORATED MAKES NO WARRANTY OF ANY KIND, EXPRESS OR IMPLIED, WITH REGARDS TO THIS DOCUMENT, INCLUDING, BUT NOT LIMITED TO, THE IMPLIED WARRANTIES OF MERCHANTABILITY AND FITNESS FOR A PARTICULAR PURPOSE (AND THEIR EQUIVALENTS UNDER THE LAWS OF ANY JURISDICTION).

Diodes Incorporated and its subsidiaries reserve the right to make modifications, enhancements, improvements, corrections or other changes without further notice to this document and any product described herein. Diodes Incorporated does not assume any liability arising out of the application or use of this document or any product described herein; neither does Diodes Incorporated convey any license under its patent or trademark rights, nor the rights of others. Any Customer or user of this document or products described herein in such applications shall assume all risks of such use and will agree to hold Diodes Incorporated and all the companies whose products are represented on Diodes Incorporated website, harmless against all damages.

Diodes Incorporated does not warrant or accept any liability whatsoever in respect of any products purchased through unauthorized sales channel. Should Customers purchase or use Diodes Incorporated products for any unintended or unauthorized application, Customers shall indemnify and hold Diodes Incorporated and its representatives harmless against all claims, damages, expenses, and attorney fees arising out of, directly or indirectly, any claim of personal injury or death associated with such unintended or unauthorized application.

Products described herein may be covered by one or more United States, international or foreign patents pending. Product names and markings noted herein may also be covered by one or more United States, international or foreign trademarks.

This document is written in English but may be translated into multiple languages for reference. Only the English version of this document is the final and determinative format released by Diodes Incorporated.

**LIFE SUPPORT**

Diodes Incorporated products are specifically not authorized for use as critical components in life support devices or systems without the express written approval of the Chief Executive Officer of Diodes Incorporated. As used herein:

A. Life support devices or systems are devices or systems which:

1. are intended to implant into the body, or
2. support or sustain life and whose failure to perform when properly used in accordance with instructions for use provided in the labeling can be reasonably expected to result in significant injury to the user.

B. A critical component is any component in a life support device or system whose failure to perform can be reasonably expected to cause the failure of the life support device or to affect its safety or effectiveness.

Customers represent that they have all necessary expertise in the safety and regulatory ramifications of their life support devices or systems, and acknowledge and agree that they are solely responsible for all legal, regulatory and safety-related requirements concerning their products and any use of Diodes Incorporated products in such safety-critical, life support devices or systems, notwithstanding any devices- or systems-related information or support that may be provided by Diodes Incorporated. Further, Customers must fully indemnify Diodes Incorporated and its representatives against any damages arising out of the use of Diodes Incorporated products in such safety-critical, life support devices or systems.

Copyright © 2017, Diodes Incorporated

[www.diodes.com](http://www.diodes.com)