

Features

- Input voltage range: 2.2V~5V (V_{OUT} type)
- Oscillator frequency: 700KHz (Typ.)
- Internal reference: 1.0V (Typ.)
- High efficiency: 93% (Typ.)
- Current limit and thermal shutdown protection
- Lead Free Package: SOP-8L
- SOP-8L: Available in "Green" Molding Compound (No Br, Sb)
- **Lead Free Finish/ RoHS Compliant (Note 1)**
- **For automotive applications requiring specific change control (i.e. parts qualified to AEC-Q100/101/200, PPAP capable, and manufactured in IATF 16949 certified facilities), please [contact us](#) or your local Diodes representative.**
<https://www.diodes.com/quality/product-definition/s/>

General Description

The AP1635 series are multi-functional step-down DC/DC converters with built-in speed, low ON resistance drivers. It is capable to deliver more than 1.2A output current with external coil, diode and capacitor.

Output voltage is set-up by the external resistors. ($\pm 2.5\%$ accuracy). The 700KHz AP1635 that can work out with small value external components comes out more compact board.

The device switches to and works under PFM mode with light loads. It keeps at high efficiency for both light loads and large output current.

AP1635 can be soft-start with a proper capacitor connected between CE/SS pin and ground. The stand-by current is less than 6uA when CE/SS pin is at "LOW" status. The device is forced to switch off as the voltage at that pin is lower than the stipulated voltage.

Applications

- Electronic Information Organizers
- Palmtops
- Cellular and portable phones
- Portable Audio Systems
- Various Multi-function Power Supplies

Ordering Information

AP 1635 S X - 13

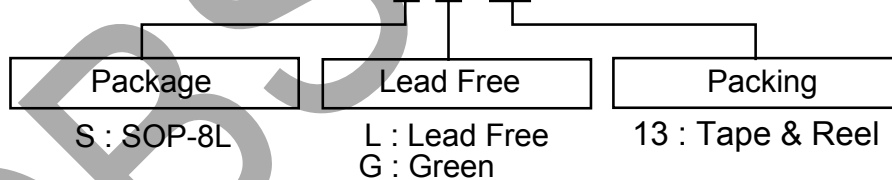

Device	Package Code	Packaging (Note 2)	13" Tape and Reel	
			Quantity	Part Number Suffix
AP1635SL-13	S	SOP-8L	2500/Tape & Reel	-13
AP1635SG-13	S	SOP-8L	2500/Tape & Reel	-13

- Notes:
1. EU Directive 2002/95/EC (RoHS). All applicable RoHS exemptions applied. Please visit our website at http://www.diodes.com/products/lead_free.html.
 2. Pad layout as shown on Diodes Inc. suggested pad layout document AP02001, which can be found on our website at <http://www.diodes.com/datasheets/ap02001.pdf>.

Pin Assignments

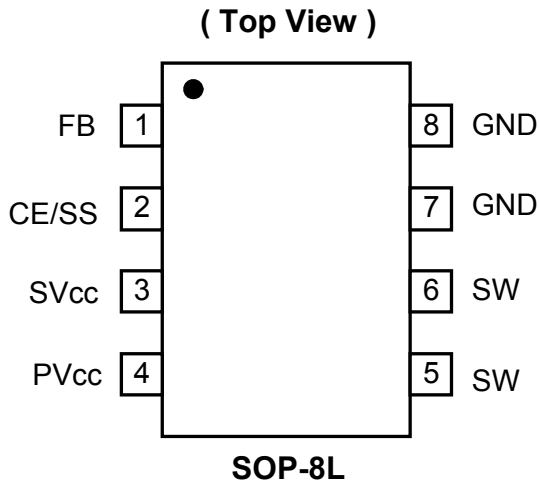

Pin Descriptions

Pin Name	Pin No.	Description
FB	1	Feedback pin
CE/SS	2	Chip Enable/ Soft Start: H: Enable L: Disable
SVcc	3	IC signal power supply pin, add a 20Ω resistor to PVcc and a 0.1μF capacitor to GND.
PVcc	4	IC power supply pin
SW	5/6	Switch Pin. Connect external inductor/diode here. Minimize trace area at this pin to reduce EMI.
GND	7/8	GND Pin

OBSOLETE - PART DISCONTINUED

Block Diagram

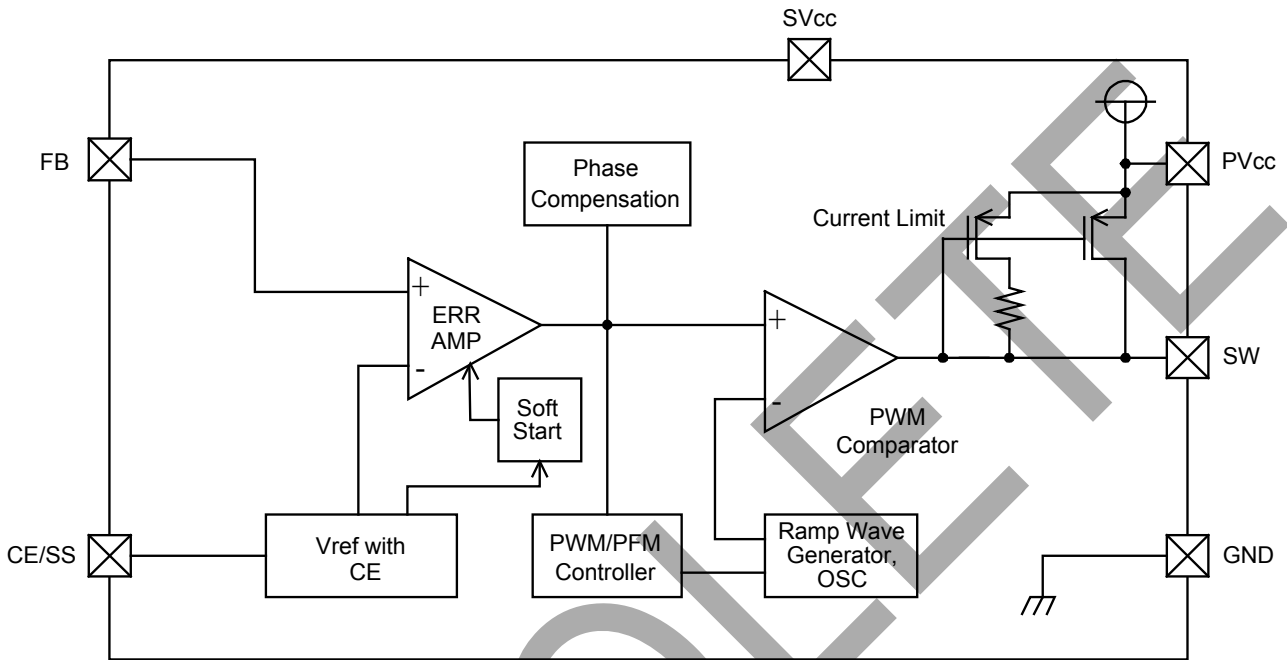

Absolute Maximum Ratings ($T_A=25^\circ\text{C}$)

Symbol	Parameter	Ratings	Units
V_{CC}/SV_{CC}	V_{IN} Pin Voltage	-0.3 ~ 5.0	V
V_{SW}	SW Pin Voltage	-0.3 ~ $V_{IN}+0.3$	V
V_{FB}	FB Pin Voltage	-0.3 ~ $V_{IN}+0.3$	V
$V_{CE/SS}$	CE/SS Pin Voltage	-0.3 ~ $V_{IN}+0.3$	V
PD	Continuous Total Power Dissipation	Internal limited	
T_{OPR}	Operating Ambient Temperature	-25 ~ +80	$^\circ\text{C}$
T_{STG}	Storage Temperature	-40 ~ +125	$^\circ\text{C}$

Electrical Characteristics
 $V_{IN}=5V, V_{OUT}=2V, Load=300mA, T_A=25^{\circ}C$

Symbol	Parameter	Conditions	Min	Typ.	Max	Units
V_{FB}	FB		0.975	1.0	1.025	V
V_{IN}	Input Voltage		2.2	-	5	V
	Line Regulation	$V_{IN}=2.2\sim 5V, Load=10mA$	-	-	0.12	%
	Load Regulation	$I_{OUT}=10\sim 1200mA$	-	-	1.2	%
V_{UVLO}	UVLO Voltage (min. operating voltage)	V_{CC} , voltage required to maintain H at V_{OUT}	-	-	2	V
I_{CC}	Operating Current	CE/SS= V_{IN} , No Load	-	100	150	μA
I_{CCQ}	Supply Current	No external components, CE/SS= V_{IN} , $V_{FB}=1.2V$	-	90	120	μA
I_{STB}	Stand-by Current	No external components, CE/SS=0V, $V_{FB}=0V$	-	6	-	μA
I_{CL}	Current Limit	Peak current $V_{IN}=5V, V_{OUT}=2V$	1200	1400	1600	mA
F_{osc}	Oscillator Frequency	Load=300mA, $V_{IN}=5V, V_{OUT}=2V$	500	700	-	kHz
MAXDTY	Maximum Duty Ratio		85	90	-	%
PFMDTY	PFM Duty Ratio	No load	15	25	35	%
V_{CEH}	CE/SS "High" Voltage	Apply 1.4V (min.) to CE/SS, determine V_{OUT} "High"	1.4	-	-	V
V_{CEL}	CE/SS "Low" Voltage	Same as V_{CEH} , determine V_{OUT} "Low"	-	-	0.6	V
EFFI	Efficiency	$V_{CC}=5V, V_{OUT}=3.3V, Load=300mA$	-	93	-	%
Rdson	Rdson Condition	$I_{OUT}=300mA, V_{IN}=5V, V_{OUT}=2V$	-	350	450	m Ω

OBSOLETE

Typical Performance Characteristics

Vcc vs. Operating Current

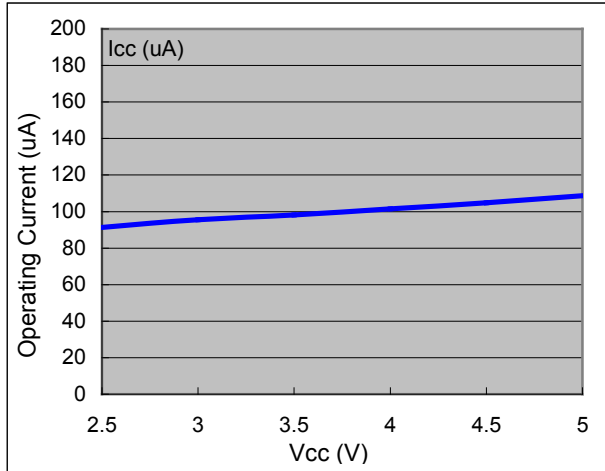

Vcc vs. Quiescent Current

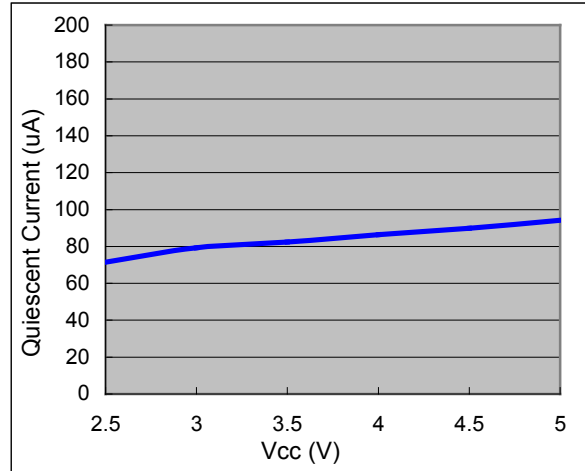

Vcc vs. Stand-by Current

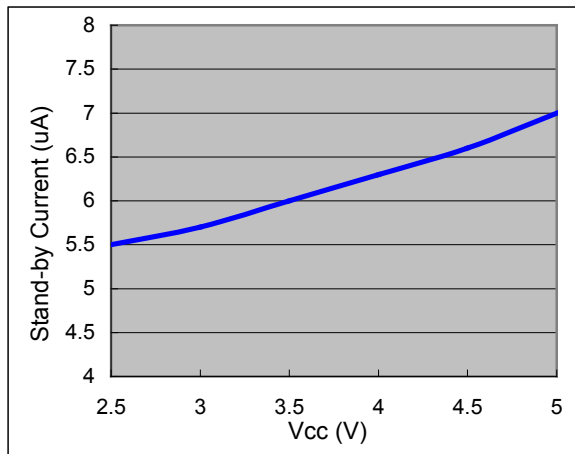

Vcc vs. Frequency

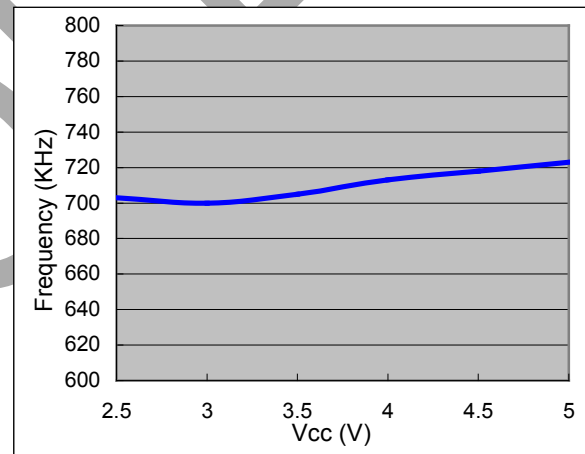

Vcc vs. Current Limit

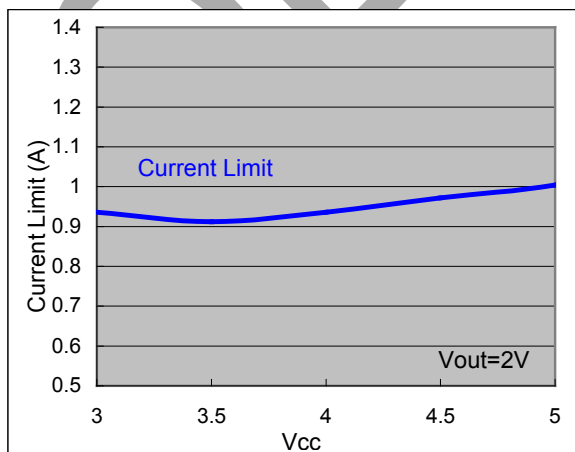

Vcc vs. R_{DS(ON)}

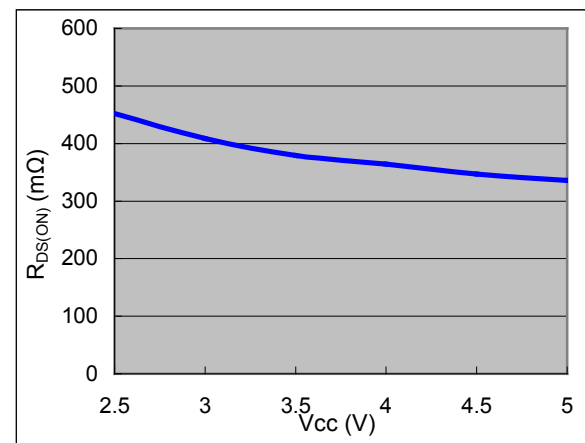

Typical Performance Characteristics (Continued)

Line Regulation

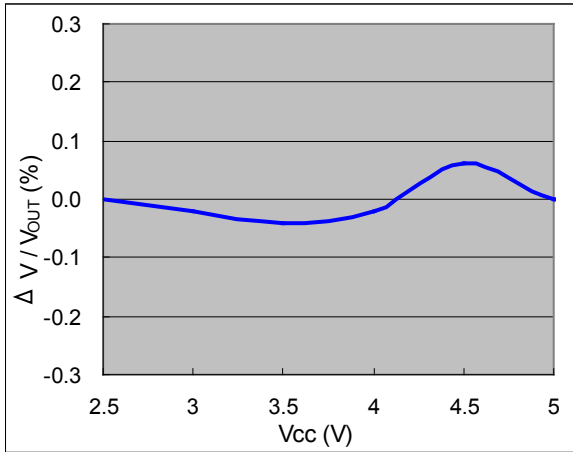

Load Regulation

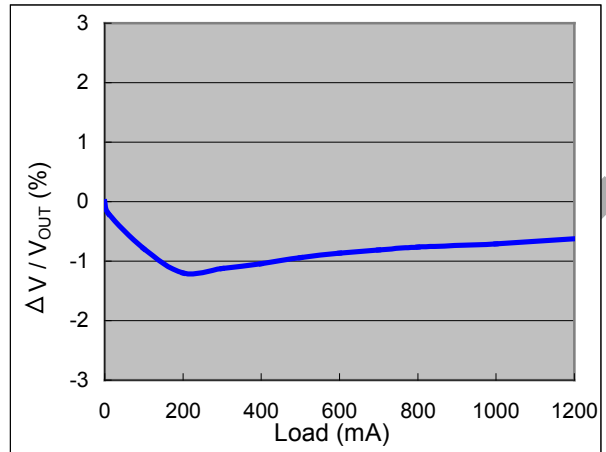

Typical Application Circuit

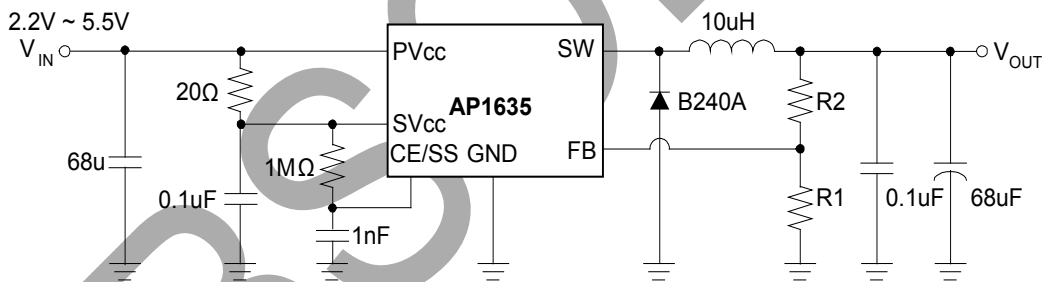

$$V_{out} = 1 \times \left(1 + \frac{R2}{R1}\right)$$

R1=100K ~ 200K

Marking Information

(1) SOP-8L

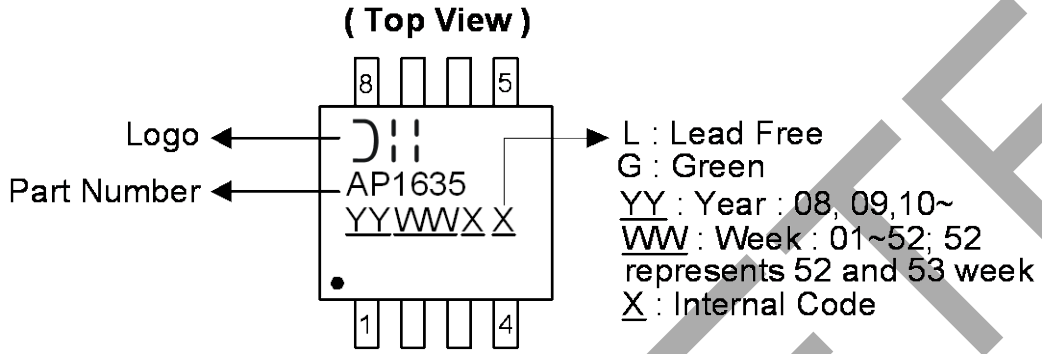

Package Information (All Dimensions in mm)

(1) Package Type: SOP-8L

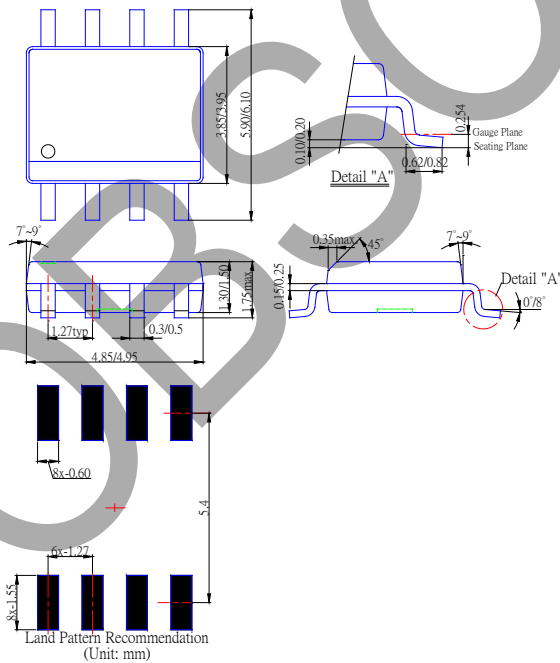

IMPORTANT NOTICE

DIODES INCORPORATED MAKES NO WARRANTY OF ANY KIND, EXPRESS OR IMPLIED, WITH REGARDS TO THIS DOCUMENT, INCLUDING, BUT NOT LIMITED TO, THE IMPLIED WARRANTIES OF MERCHANTABILITY AND FITNESS FOR A PARTICULAR PURPOSE (AND THEIR EQUIVALENTS UNDER THE LAWS OF ANY JURISDICTION).

Diodes Incorporated and its subsidiaries reserve the right to make modifications, enhancements, improvements, corrections or other changes without further notice to this document and any product described herein. Diodes Incorporated does not assume any liability arising out of the application or use of this document or any product described herein; neither does Diodes Incorporated convey any license under its patent or trademark rights, nor the rights of others. Any Customer or user of this document or products described herein in such applications shall assume all risks of such use and will agree to hold Diodes Incorporated and all the companies whose products are represented on Diodes Incorporated website, harmless against all damages.

Diodes Incorporated does not warrant or accept any liability whatsoever in respect of any products purchased through unauthorized sales channel.

Should Customers purchase or use Diodes Incorporated products for any unintended or unauthorized application, Customers shall indemnify and hold Diodes Incorporated and its representatives harmless against all claims, damages, expenses, and attorney fees arising out of, directly or indirectly, any claim of personal injury or death associated with such unintended or unauthorized application.

Products described herein may be covered by one or more United States, international or foreign patents pending. Product names and markings noted herein may also be covered by one or more United States, international or foreign trademarks.

This document is written in English but may be translated into multiple languages for reference. Only the English version of this document is the final and determinative format released by Diodes Incorporated.

LIFE SUPPORT

Diodes Incorporated products are specifically not authorized for use as critical components in life support devices or systems without the express written approval of the Chief Executive Officer of Diodes Incorporated. As used herein:

- A. Life support devices or systems are devices or systems which:
1. are intended to implant into the body, or
 2. support or sustain life and whose failure to perform when properly used in accordance with instructions for use provided in the labeling can be reasonably expected to result in significant injury to the user.
- B. A critical component is any component in a life support device or system whose failure to perform can be reasonably expected to cause the failure of the life support device or to affect its safety or effectiveness.

Customers represent that they have all necessary expertise in the safety and regulatory ramifications of their life support devices or systems, and acknowledge and agree that they are solely responsible for all legal, regulatory and safety-related requirements concerning their products and any use of Diodes Incorporated products in such safety-critical, life support devices or systems, notwithstanding any devices- or systems-related information or support that may be provided by Diodes Incorporated. Further, Customers must fully indemnify Diodes Incorporated and its representatives against any damages arising out of the use of Diodes Incorporated products in such safety-critical, life support devices or systems.

Copyright © 2020, Diodes Incorporated

www.diodes.com