

Description

The AP1507 is a monolithic IC designed for a step-down DC/DC converter and is capable of driving a 3A load without an external transistor. Due to reducing the number of external components, the board space can be saved easily.

The external shutdown function can be controlled by logic level and then go into standby mode. The internal compensation makes the feedback control have good line and load regulation without an external design. Regarding the protected function, the thermal shutdown prevents overtemperature operation from damaging the device, and current limit protects against overcurrent operation of the output switch. If the current limit function occurs, and V_{FB} is down to 0.5V below, the switching frequency reduces.

The AP1507 series operates at a switching frequency of 150kHz, which allows smaller-sized filter components than the requirements with lower frequency switching regulators.

Other features include a guaranteed $\pm 4\%$ tolerance on output voltage under specified input voltage and output load conditions and $\pm 15\%$ on the oscillator frequency. The output version included a fixed 3.3V, 5V, 12V, and an adjustable type.

AP1507 is available in a 5-lead TO252-5 green package.

Features

- Output Voltage: 3.3V, 5V, 12V and Adjustable Output Version
- Adjustable Version Output Voltage Range, 1.23V to 18V $\pm 4\%$
- 150kHz $\pm 15\%$ Fixed Switching Frequency
- Voltage Mode Non-Synchronous PWM Control
- Thermal-Shutdown and Current-Limit Protection
- ON/OFF Shutdown Control Input
- Operating Voltage up to 22V
- Output Load Current: 3A
- Low Power Standby Mode
- Built-in Switching Transistor On Chip
- **Totally Lead-Free & Fully RoHS Compliant (Notes 1 & 2)**
- **Halogen and Antimony Free. "Green" Device (Note 3)**
- **For automotive applications requiring specific change control (i.e. parts qualified to AEC-Q100/101/200, PPAP capable, and manufactured in IATF 16949 certified facilities), please [contact us](#) or your local Diodes representative.**

<https://www.diodes.com/quality/product-definitions>

- Notes:
1. No purposely added lead. Fully EU Directive 2002/95/EC (RoHS), 2011/65/EU (RoHS 2) & 2015/863/EU (RoHS 3) compliant.
 2. See <https://www.diodes.com/quality/lead-free/> for more information about Diodes Incorporated's definitions of Halogen- and Antimony-free, "Green" and Lead-free.
 3. Halogen- and Antimony-free "Green" products are defined as those which contain <900ppm bromine, <900ppm chlorine (<1500ppm total Br + Cl) and <1000ppm antimony compounds.

Pin Assignments

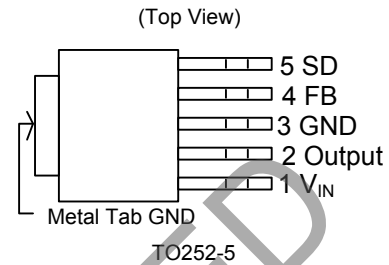

Applications

- Simple High-Efficiency Step-Down Regulator
- On-Card Switching Regulators
- Positive to Negative Converter

Typical Application Circuit

(1) Fixed Type Circuit

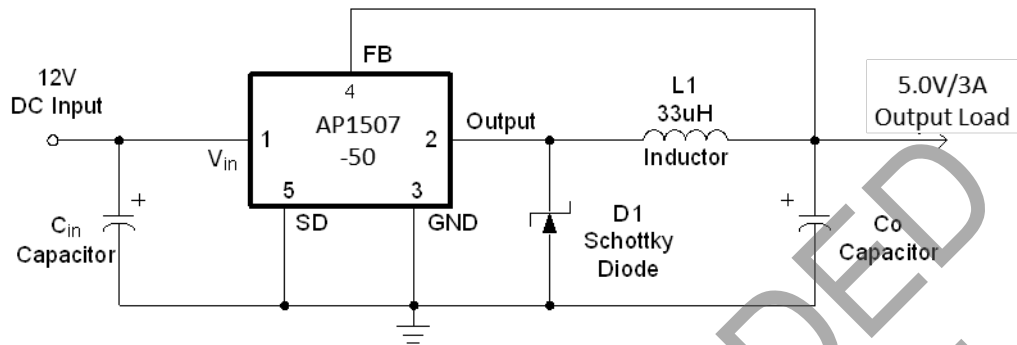

(2) Adjustable Type Circuit

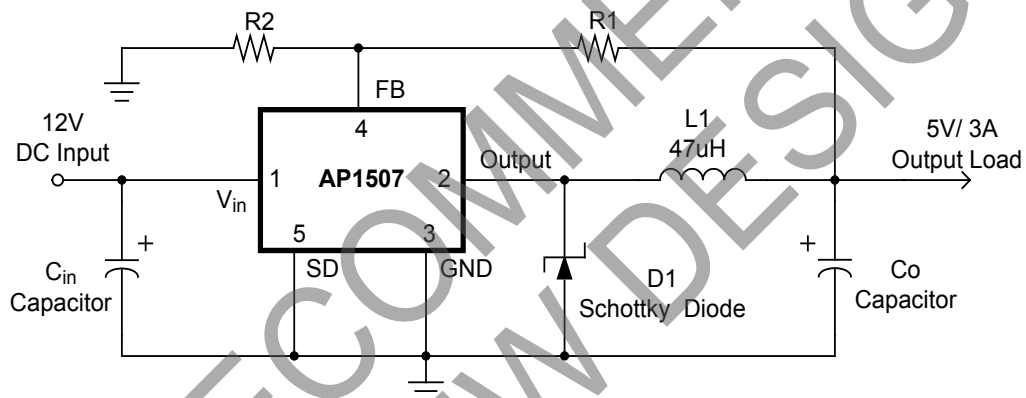

$$V_{OUT} = V_{FB} \times \left(1 + \frac{R1}{R2}\right)$$

$$V_{FB} = 1.23V, R2 = 1K \sim 3K$$

(3) Delay Start Circuit

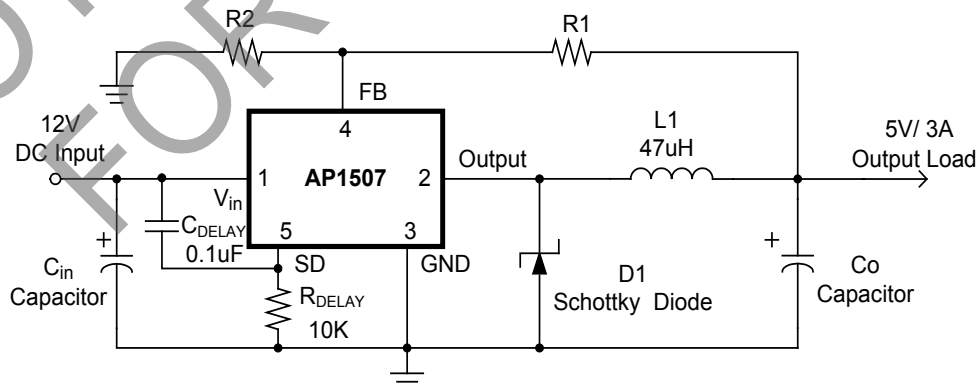

Pin Descriptions

Pin Number	Pin Name	Description
1	V _{IN}	Operating Voltage Input
2	Output	Switching Output
3	GND	Ground
4	FB	Output Voltage Feedback Control
5	SD	ON / OFF Shutdown

Functional Block Diagram

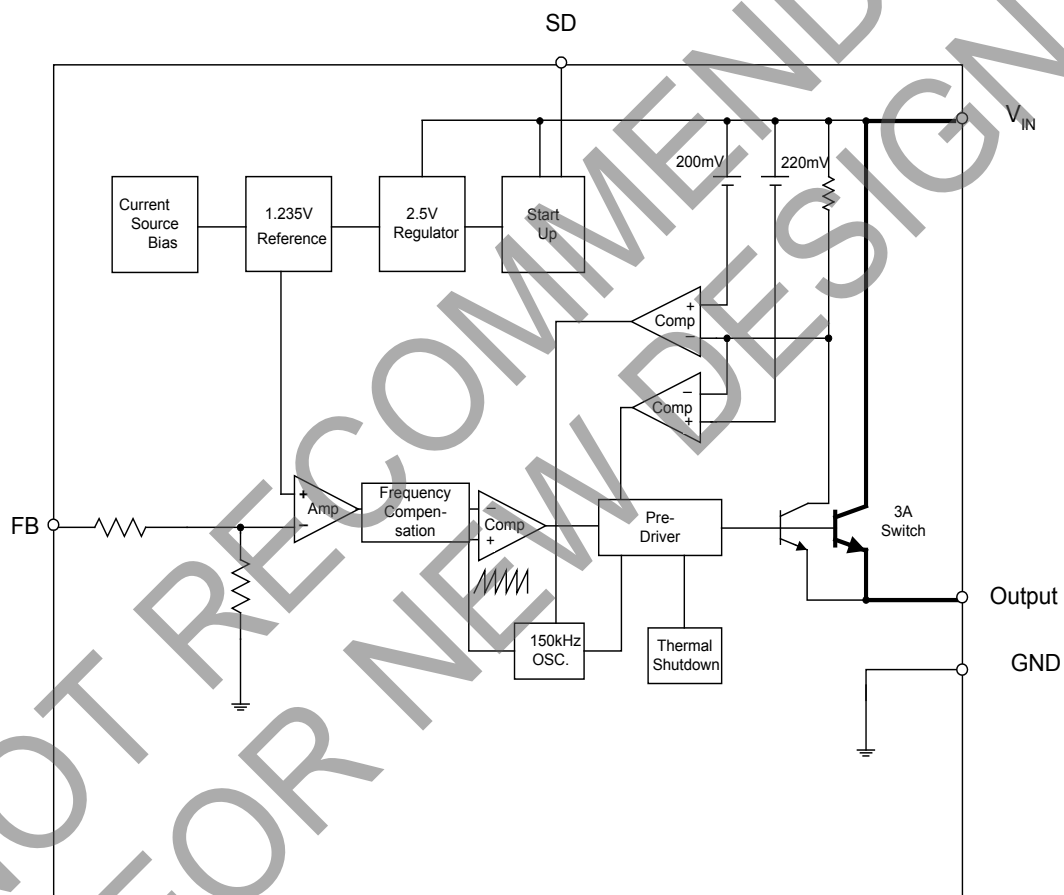

Absolute Maximum Ratings (T_A = +25°C) (Note 4)

Symbol	Parameter	Rating	Unit
ESD HBM	Human Body Model ESD Protection	2	KV
ESD MM	Machine Model ESD Protection	200	V
V _{CC}	Supply Voltage	+24	V
V _{SD}	ON/OFF Pin Input Voltage	-0.3 to +18	V
V _{FB}	Feedback Pin Voltage	-0.3 to +18	V
V _{OUT}	Output Voltage to Ground	-1	V
P _D	Power Dissipation	Internally Limited	W
T _{ST}	Storage Temperature	-65 to +150	°C
T _J	Operating Junction Temperature	-40 to +125	°C

Note: 4. Stresses greater than the *Absolute Maximum Ratings* specified above, can cause permanent damage to the device. These are stress ratings only; functional operation of the device at these or any other conditions exceeding those indicated in this specification is not implied. Device reliability can be affected by exposure to absolute maximum rating conditions for extended periods of time.

Recommended Operating Conditions (T_A = +25°C)

Symbol	Parameter	Min	Max	Unit
I _{OUT}	Output Current	0	3	A
V _{OP}	Operating Voltage	4.5	22	V
T _A	Operating Ambient Temperature	-20	+85	°C

NOT RECOMMENDED FOR NEW DESIGN

Electrical Characteristics (All Output Voltage Versions)

Unless otherwise specified, $V_{IN} = 12V$ for 3.3V, 5V, adjustable version and $V_{IN} = 18V$ for the 12V version. $I_{LOAD} = 0.5A$
 Specifications with **boldface type** are for full operating temperature range, the other type are for $T_J = 25^\circ C$.

Symbol	Parameter		Conditions	Min	Typ	Max	Unit
I_{FB}	Feedback Bias Current		$V_{FB} = 1.3V$ (Adjustable Version Only)	—	-10	-50 -100	nA
F_{OSC}	Oscillator Frequency		—	127 110	150	173 173	kHz
F_{SCP}	Oscillator Frequency of Short-Circuit Protect		When Current Limit Occurred and $V_{FB} < 0.5V$, $T_A = 25^\circ C$	10	30	50	kHz
V_{SAT}	Saturation Voltage		$I_{OUT} = 3A$ No Outside Circuit $V_{FB} = 0V$ Force Driver On	—	1.4	1.6 1.7	V
DC	Max. Duty Cycle (ON)		$V_{FB} = 0V$ Force Driver On	—	100	—	%
	Min. Duty Cycle (OFF)		$V_{FB} = 12V$ Force Driver Off	—	0	—	
I_{CL}	Current Limit		Peak Current	3.6	4.5	5.5	A
			No Outside Circuit $V_{FB} = 0V$ Force Driver On			6.5	
I_{LEAK}	Output = 0V	Output Leakage Current	No Outside Circuit $V_{FB} = 12V$ Force Driver Off	—	—	-200	μA
	Output = -1V		$V_{IN} = 22V$	—	-5	—	mA
I_Q	Quiescent Current		$V_{FB} = 12V$ Force Driver Off	—	5	10	mA
I_{STBY}	Standby Quiescent Current		ON/OFF Pin = 5V $V_{IN} = 22V$	—	70	150 200	μA
			Low (Regulator ON)	—	1.3	0.6	V
V_{IH}	ON/OFF Pin Logic Input Threshold Voltage		High (Regulator OFF)	2.0	—	—	
I_H	ON/OFF Pin Logic Input Current		$V_{LOGIC} = 2.5V$ (OFF)	—	—	-0.01	μA
I_L	ON/OFF Pin Input Current		$V_{LOGIC} = 0.5V$ (ON)	—	-0.1	-1	
θ_{JA}	Thermal Resistance		TO252-5	Junction to Case		—	$^\circ C/W$
θ_{JC}	Thermal Resistance (Copper Area of Approximately 2cm × 2cm)		TO252-5	Junction to Ambient		—	$^\circ C/W$

Electrical Characteristics (continued) (All Output Voltage Versions)

Specifications with **boldface type** are for full operating temperature range, the other type are for $T_J = +25^\circ\text{C}$.

—	Symbol	Parameter	Conditions	V _{MIN}	Typ.	V _{MAX}	Unit
AP1507-ADJ	V _{FB}	Output Feedback	5V ≤ V _{IN} ≤ 22V 0.2A ≤ I _{LOAD} ≤ 3A V _{OUT} Programmed for 3V	1.193 1.18	1.23	1.267 1.28	V
	η	Efficiency	V _{IN} = 12V, I _{LOAD} = 3A	—	74	—	%
AP1507-3.3V	V _{OUT}	Output Voltage	5.5V ≤ V _{IN} ≤ 22V 0.2A ≤ I _{LOAD} ≤ 3A	3.168 3.135	3.3	3.432 3.465	V
	η	Efficiency	V _{IN} = 12V, I _{LOAD} = 3A	—	75	—	%
AP1507-5V	V _{OUT}	Output Voltage	8V ≤ V _{IN} ≤ 22V 0.2A ≤ I _{LOAD} ≤ 3A	4.8 4.75	5	5.2 5.25	V
	η	Efficiency	V _{IN} = 12V, I _{LOAD} = 3A	—	80	—	%
AP1507-12V	V _{OUT}	Output Voltage	15V ≤ V _{IN} ≤ 22V 0.2A ≤ I _{LOAD} ≤ 3A	11.52 11.4	12	12.48 12.6	V
	η	Efficiency	V _{IN} = 16V, I _{LOAD} = 3A	—	89	—	%

NOT RECOMMENDED FOR NEW DESIGN

Typical Characteristics

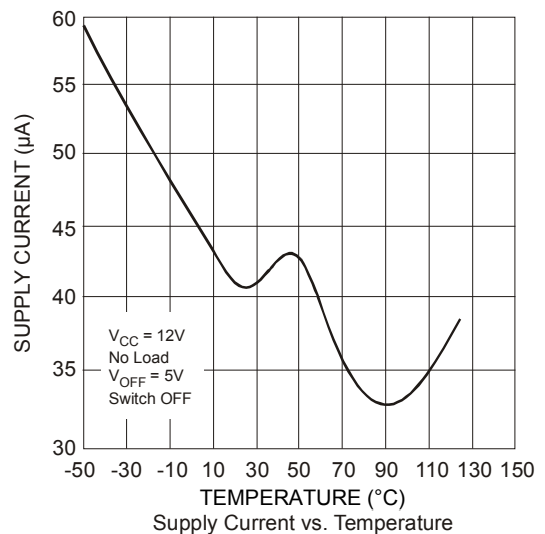
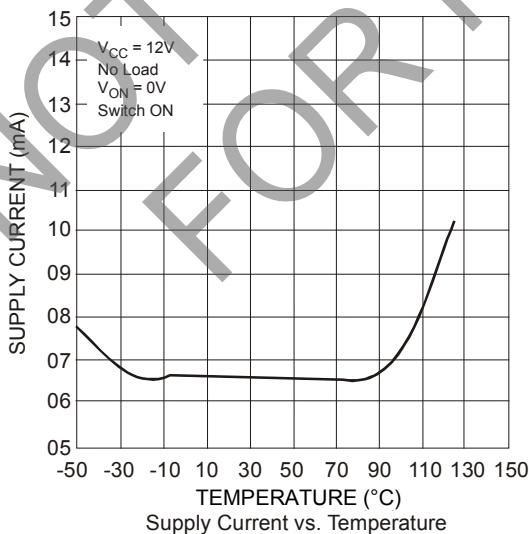
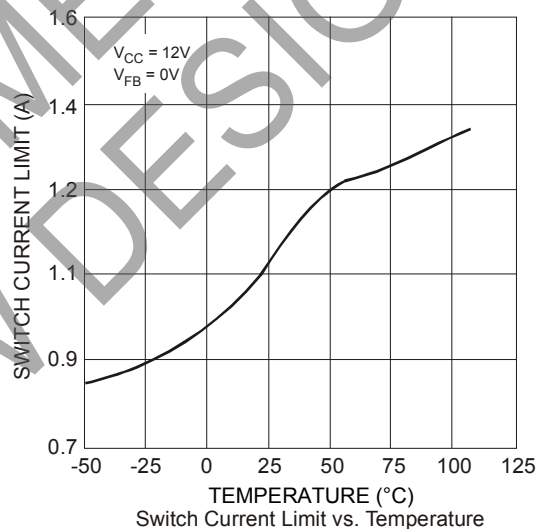
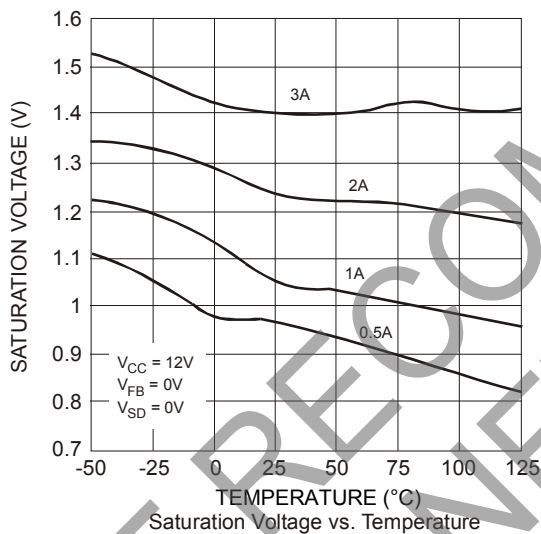
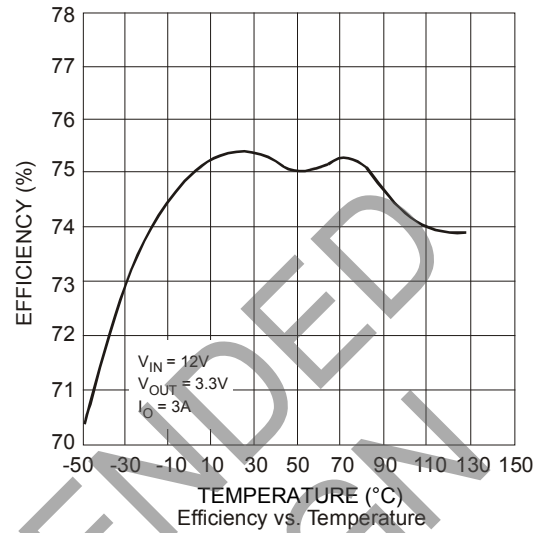
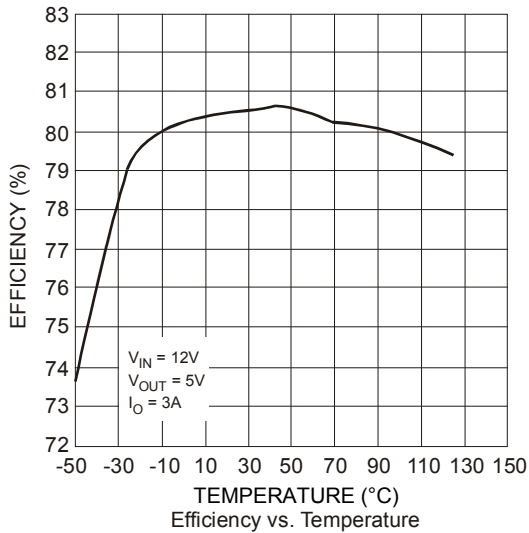

Typical Characteristics (continued)

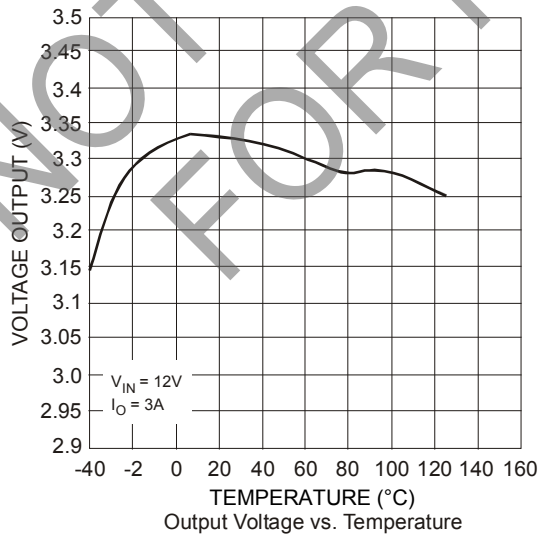
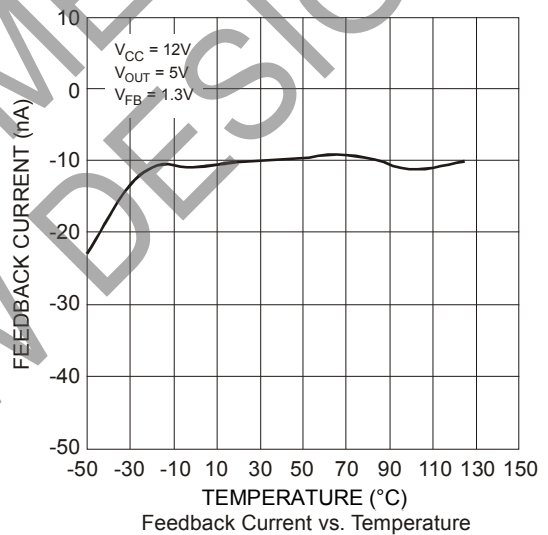
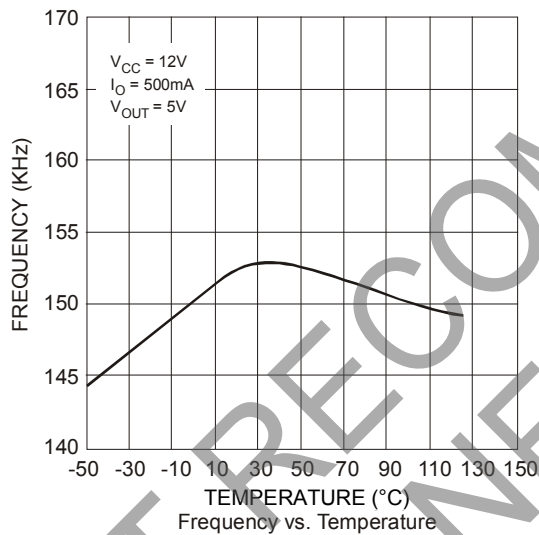
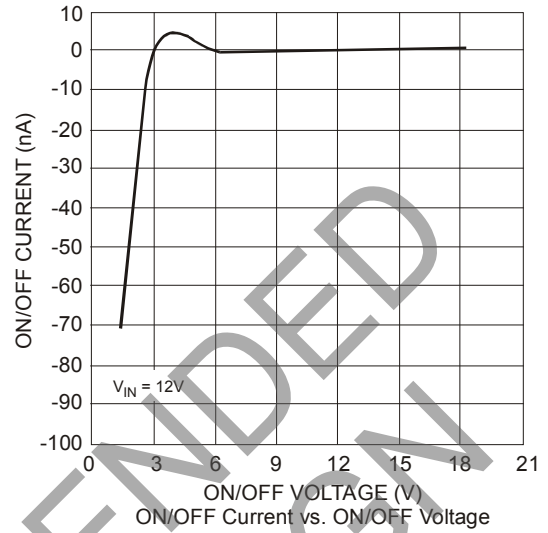
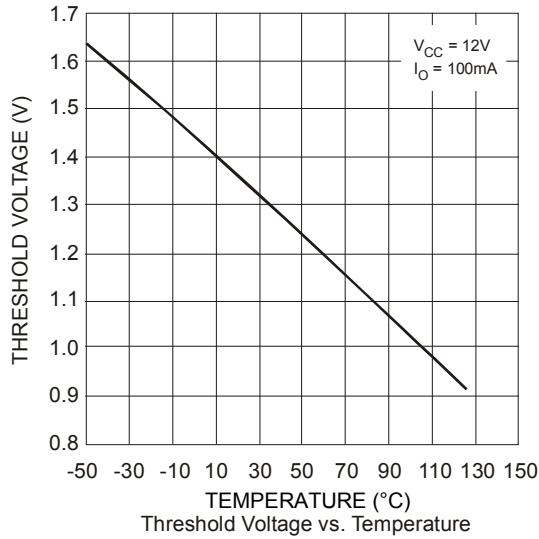

Application Information

Pin Functions

+V_{IN}

This is the positive input supply for the IC switching regulator. A suitable input bypass capacitor must be present at this pin to minimize voltage transients and to supply the switching currents needed by the regulator.

Ground

Circuit ground.

Output

Internal switch. The voltage at this pin switches between (+V_{IN} – V_{SAT}) and approximately -0.5V with a duty cycle of approximately V_{OUT}/V_{IN}. To minimize coupling to sensitive circuitry, the PCB copper area connected to this pin must be kept at a minimum.

Feedback (FB)

Senses the regulated output voltage to complete the feedback loop.

ON/OFF (SD)

Allows the switching regulator circuit to be shutdown using logic level signals thus dropping the total input supply current to approximately 150μA. Pulling this pin below a threshold voltage of approximately 1.3V turns the regulator on, and pulling this pin above 1.3V (up to a maximum of 18V) shuts the regulator down. If this shutdown feature is not required, the ON/OFF pin can be wired to the ground pin.

Thermal Considerations

The TO252-5 surface mount package tab is designed to be soldered to the copper on a PCB. The copper and the board are the heat sink for this package and the other heat producing components, such as the catch diode and inductor. The PCB copper area that the package is soldered to should be at least 0.8 in² and ideally should have two or more square inches of 2oz additional copper area, which improves the thermal characteristics. With copper areas greater than approximately 6in², only small improvements in heat dissipation are realized. If further thermal improvements are required, double sided, multi-layer PCBs with large copper areas and/or airflow are recommended.

The AP1507 (TO252-5 package) junction temperature rises above ambient temperature with a 3A load for various input and output voltages. This data was taken with the circuit operating as a buck-switching regulator with all components mounted on a PCB to simulate the junction temperature under actual operating conditions. This curve can be used for a quick check for the approximate junction temperature for various conditions, but there are many factors that can affect the junction temperature. When load currents higher than 3A are used, double-sided or multi-layer PCBs with large copper areas and/or airflow might be required, especially for high ambient temperatures and high output voltages.

For the best thermal performance, wide copper traces and generous amounts of PCB copper should be used in the board layout. One exception to this is the output (switch) pin, which should not have large areas of copper. Large areas of copper provide the best transfer of heat (lower thermal resistance) to the surrounding air, and moving air lowers the thermal resistance even further.

Package thermal resistance and junction temperature rise numbers are all approximate, and there are many factors that will affect these numbers. Some of these factors include board size, shape, thickness, position, location, and even board temperature. Other factors are trace width, total PC copper area, copper thickness, single- or double-sided, multi-layer board, and the amount of solder on the board. The effectiveness of the PCB to dissipate heat also depends on the size, quantity, and spacing of other components on the board, as well as whether the surrounding air is still or moving. Furthermore, some of these components, such as the catch diode, add heat to the PCB, and the heat can vary as the input voltage changes. Depending on the physical size, type of core material, and the DC resistance, the inductor can either act as a heat sink taking heat away from the board, or it could add heat to the board.

Ordering Information

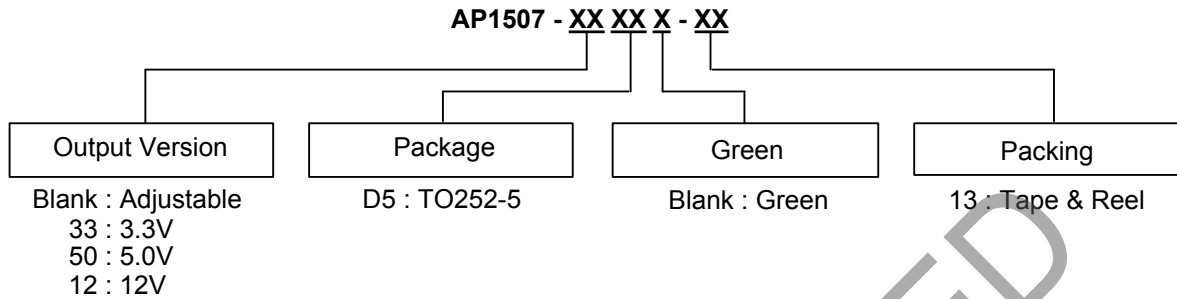

Device	Voltage (V)	Package Code	Package (Note 5)	Lead Free/Green	Quantity	Part Number Suffix		Status
						Tube	13" Tape and Reel	
AP1507-12D5-13	12	K5	TO252-5	Green	800	NA	-13	End of Life
AP1507-33D5-13	3.3	K5	TO252-5	Green	800	NA	-13	End of Life
AP1507-50D5-13	5.0	K5	TO252-5	Green	800	NA	-13	End of Life
AP1507-D5-13	ADJ	K5	TO252-5	Green	800	NA	-13	NRND

Notes: 5. For packaging details, go to our website at <https://www.diodes.com/design/support/packaging/diodes-packaging/>.

Marking Information

(1) TO252-5

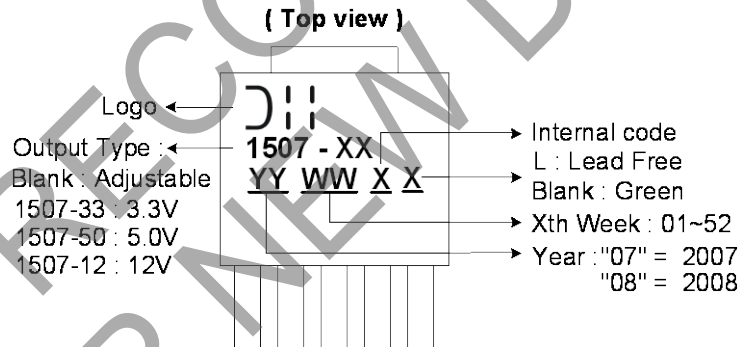

Package Outline Dimensions

Please see <http://www.diodes.com/package-outlines.html> for the latest version.

TO252-5

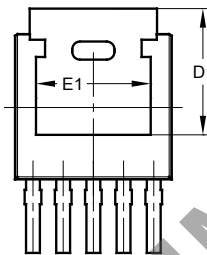
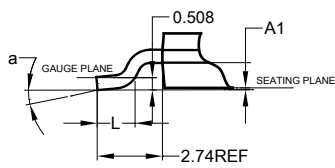
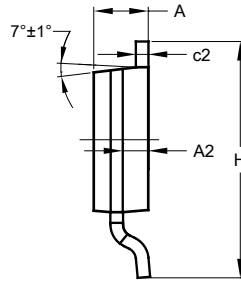
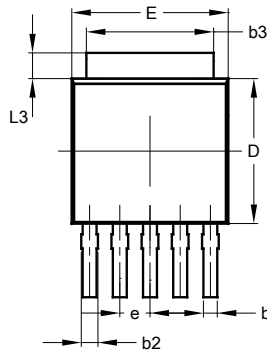

TO252-5			
Dim	Min	Max	Typ
A	2.19	2.39	2.29
A1	0.00	0.13	0.08
A2	0.97	1.17	1.07
b	0.51	0.71	0.583
b2	0.61	0.79	0.70
b3	5.21	5.46	5.33
c2	0.45	0.58	0.531
D	6.00	6.20	6.10
D1	5.21	—	—
e	—	—	1.27
E	6.45	6.70	6.58
E1	4.32	—	—
H	9.40	10.41	9.91
L	1.40	1.78	1.59
L3	0.88	1.27	1.08
a	0°	10°	—
All Dimensions in mm			

Suggested Pad Layout

Please see <http://www.diodes.com/package-outlines.html> for the latest version.

TO252-5

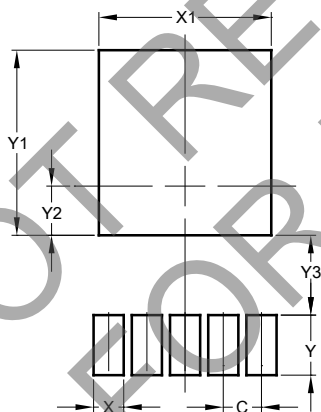

Dimensions	Value (in mm)
C	1.27
X	1.00
X1	5.73
Y	2.00
Y1	6.17
Y2	1.64
Y3	2.66

IMPORTANT NOTICE

DIODES INCORPORATED MAKES NO WARRANTY OF ANY KIND, EXPRESS OR IMPLIED, WITH REGARDS TO THIS DOCUMENT, INCLUDING, BUT NOT LIMITED TO, THE IMPLIED WARRANTIES OF MERCHANTABILITY AND FITNESS FOR A PARTICULAR PURPOSE (AND THEIR EQUIVALENTS UNDER THE LAWS OF ANY JURISDICTION).

Diodes Incorporated and its subsidiaries reserve the right to make modifications, enhancements, improvements, corrections or other changes without further notice to this document and any product described herein. Diodes Incorporated does not assume any liability arising out of the application or use of this document or any product described herein; neither does Diodes Incorporated convey any license under its patent or trademark rights, nor the rights of others. Any Customer or user of this document or products described herein in such applications shall assume all risks of such use and will agree to hold Diodes Incorporated and all the companies whose products are represented on Diodes Incorporated website, harmless against all damages.

Diodes Incorporated does not warrant or accept any liability whatsoever in respect of any products purchased through unauthorized sales channel. Should Customers purchase or use Diodes Incorporated products for any unintended or unauthorized application, Customers shall indemnify and hold Diodes Incorporated and its representatives harmless against all claims, damages, expenses, and attorney fees arising out of, directly or indirectly, any claim of personal injury or death associated with such unintended or unauthorized application.

Products described herein may be covered by one or more United States, international or foreign patents pending. Product names and markings noted herein may also be covered by one or more United States, international or foreign trademarks.

This document is written in English but may be translated into multiple languages for reference. Only the English version of this document is the final and determinative format released by Diodes Incorporated.

LIFE SUPPORT

Diodes Incorporated products are specifically not authorized for use as critical components in life support devices or systems without the express written approval of the Chief Executive Officer of Diodes Incorporated. As used herein:

A. Life support devices or systems are devices or systems which:

1. are intended to implant into the body, or
2. support or sustain life and whose failure to perform when properly used in accordance with instructions for use provided in the labeling can be reasonably expected to result in significant injury to the user.

B. A critical component is any component in a life support device or system whose failure to perform can be reasonably expected to cause the failure of the life support device or to affect its safety or effectiveness.

Customers represent that they have all necessary expertise in the safety and regulatory ramifications of their life support devices or systems, and acknowledge and agree that they are solely responsible for all legal, regulatory and safety-related requirements concerning their products and any use of Diodes Incorporated products in such safety-critical, life support devices or systems, notwithstanding any devices- or systems-related information or support that may be provided by Diodes Incorporated. Further, Customers must fully indemnify Diodes Incorporated and its representatives against any damages arising out of the use of Diodes Incorporated products in such safety-critical, life support devices or systems.

Copyright © 2020, Diodes Incorporated

www.diodes.com