

Description

The DGD21042 is a high-voltage / high-speed gate driver capable of driving N-channel MOSFETs and IGBTs in a half bridge configuration. High-voltage processing techniques enable the DGD21042's high side to switch to 600V in a bootstrap operation.

The DGD21042 logic inputs are compatible with standard TTL and CMOS levels (down to 3.3V) to interface easily with controlling devices. The driver outputs feature high-pulse current buffers designed for minimum driver cross conduction. The DGD21042 has a fixed internal deadtime of 430ns (typical).

The DGD21042 is offered in the SO-8 (Type TH) package and operates over an extended -40°C to +125°C temperature range.

Applications

- DC-DC Converters
- DC-AC Inverters
- AC-DC Power Supplies
- Motor Controls
- Class D Power Amplifiers

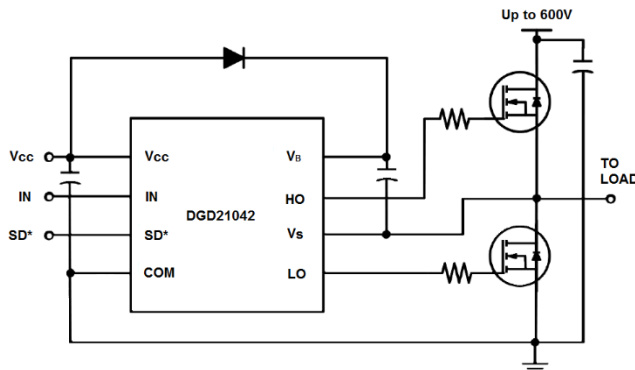

Typical Configuration

Features

- Floating High-Side Driver in Bootstrap Operation to 600V
- Drives Two N-Channel MOSFETs or IGBTs in a Half Bridge Configuration
- 290mA Source / 600mA Sink Output Current Capability
- Outputs Tolerant to Negative Transients
- Internal Dead Time of 430ns to Protect MOSFETs
- Wide Low-Side Gate Driver Supply Voltage: 10V to 20V
- Logic Input (IN and SD*) 3.3V Capability
- Schmitt Triggered Logic Inputs
- Undervoltage Lockout for V_{CC} (Logic and Low Side Supply)
- Extended Temperature Range: -40°C To +125°C
- **Totally Lead-Free & Fully RoHS Compliant (Notes 1 & 2)**
- **Halogen and Antimony Free. "Green" Device (Note 3)**

Mechanical Data

- Case: SO-8
- Case Material: Molded Plastic. "Green" Molding Compound. UL Flammability Classification Rating 94V-0
- Moisture Sensitivity: Level 3 per J-STD-020
- Terminals: Finish – Matte Tin Plated Leads Solderable per MIL-STD-202, Method 208 
- Weight: 0.074 grams (Approximate)



SO-8 (Type TH)
Top View

Ordering Information (Note 4)

Product	Marking	Reel Size (inch)	Tape Width (mm)	Quantity per Reel
DGD21042S8-13	DGD21042	13	12	2,500

- Notes:
1. No purposely added lead. Fully EU Directive 2002/95/EC (RoHS), 2011/65/EU (RoHS 2) & 2015/863/EU (RoHS 3) compliant.
 2. See <https://www.diodes.com/quality/lead-free/> for more information about Diodes Incorporated's definitions of Halogen- and Antimony-free, "Green" and Lead-free.
 3. Halogen- and Antimony-free "Green" products are defined as those which contain <900ppm bromine, <900ppm chlorine (<1500ppm total Br + Cl) and <1000ppm antimony compounds.
 4. For packaging details, go to our website at <https://www.diodes.com/design/support/packaging/diodes-packaging/>.

Marking Information

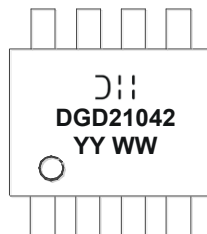

-  = Manufacturer's Marking
- DGD21042 = Product Type Marking Code
- YY = Year (ex: 19 = 2019)
- WW = Week (01 to 53)

OBSOLETE - PART DISCONTINUED

Pin Diagrams

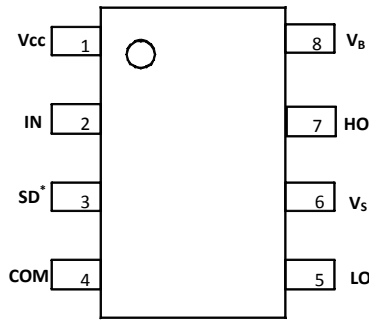

Top View: SO-8 (Type TH)

Pin Descriptions

Pin Number	Pin Name	Function
1	V _{CC}	Logic and Low Side Supply
2	IN	Logic Input for High-Side and Low-Side Gate Driver Outputs (HO and LO), in Phase with HO
3	SD*	Logic input for Shutdown, Enabled Low
4	COM	Low-Side and Logic Return
5	LO	Low-Side Gate Drive Output
6	V _S	High-Side Floating Supply Return
7	HO	High-Side Gate Drive Output
8	V _B	High-Side Floating Supply

Functional Block Diagram

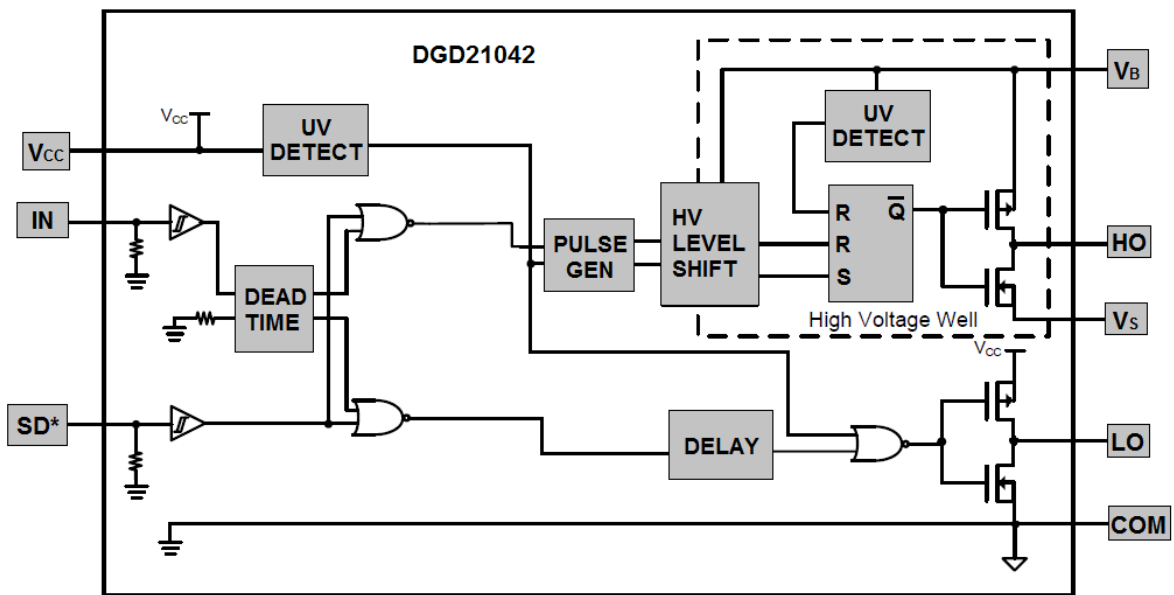

OBSOLETE - PART DISCONTINUED

Absolute Maximum Ratings (@ $T_A = +25^\circ\text{C}$, unless otherwise specified.)

Characteristic	Symbol	Value	Unit
High-Side Floating Supply Voltage	V_B	-0.3 to +624	V
High-Side Floating Supply Offset Voltage	V_S	$V_B - 24$ to $V_B + 0.3$	V
High-Side Floating Output Voltage	V_{HO}	$V_S - 0.3$ to $V_B + 0.3$	V
Offset Supply Voltage Transient	dV_S / dt	50	V/ns
Low-Side Fixed Supply Voltage	V_{CC}	-0.3 to +24	V
Low-Side Output Voltage	V_{LO}	-0.3 to $V_{CC} + 0.3$	V
Logic Input Voltage (IN and SD*)	V_{IN}	-0.3 to $V_{CC} + 0.3$	V

Thermal Characteristics (@ $T_A = +25^\circ\text{C}$, unless otherwise specified.)

Characteristic	Symbol	Value	Unit
Power Dissipation Linear Derating Factor (Note 5)	P_D	0.625	W
Thermal Resistance, Junction to Ambient (Note 5)	$R_{\theta JA}$	200	$^\circ\text{C}/\text{W}$
Operating Temperature	T_J	+150	$^\circ\text{C}$
Lead Temperature (Soldering, 10s)	T_L	+300	
Storage Temperature Range	T_{STG}	-55 to +150	

Note: 5. When mounted on a standard JEDEC 2-layer FR-4 board.

Recommended Operating Conditions

Parameter	Symbol	Min	Max	Unit
High Side Floating Supply Absolute Voltage	V_B	$V_S + 10$	$V_S + 20$	V
High Side Floating Supply Offset Voltage	V_S	(Note 6)	600	V
High Side Floating Output Voltage	V_{HO}	V_S	V_B	V
Low Side Fixed Supply Voltage	V_{CC}	10	20	V
Low Side Output Voltage	V_{LO}	0	V_{CC}	V
Logic Input Voltage (IN and SD*)	V_{IN}	0	5	V
Ambient Temperature	T_A	-40	+125	$^\circ\text{C}$

Note: 6. Logic operation for V_S of -5V to +600V. Logic state held for V_S of -5V to $-V_{BS}$.

OBSOLETE - PART DISCONTINUED

DC Electrical Characteristics (V_{BIAS} (V_{CC} , V_{BS}) = 15V, @ T_A = +25°C, unless otherwise specified.) (Note 7)

Parameter	Symbol	Min	Typ	Max	Unit	Condition
Logic "1" (IN) & Logic "0" (SD*) Input Voltage (Note 8)	V_{IH}	2.5	–	–	V	V_{CC} = 10V to 20V
Logic "0" (IN) & Logic "1" (SD*) Input Voltage (Note 8)	V_{IL}	–	–	0.8	V	V_{CC} = 10V to 20V
High Level Output Voltage, $V_{BIAS} - V_O$	V_{OH}	–	0.05	0.2	V	I_O = 2mA
Low Level Output Voltage, V_O	V_{OL}	–	0.02	0.1	V	I_O = 2mA
Offset Supply Leakage Current	I_{LK}	–	–	50	μ A	$V_B = V_S = 600V$
Quiescent V_{BS} Supply Current	I_{BSQ}	–	60	100	μ A	$V_{IN} = 0V$ or 5V
Quiescent V_{CC} Supply Current	I_{CCQ}	–	350	500	μ A	$V_{IN} = 0V$ or 5V
Logic "1" Input Bias Current	I_{IN+}	–	3.0	10	μ A	$V_{IN} = 5V$, $SD^* = 0V$
Logic "0" Input Bias Current	I_{IN-}	–	–	5.0	μ A	$V_{IN} = 0V$, $SD^* = 5V$
V_{CC} Supply Undervoltage Positive Going Threshold	V_{CCUV+}	7.4	8.5	9.6	V	–
V_{CC} Supply Undervoltage Negative Going Threshold	V_{CCUV-}	7.1	7.8	8.8	V	–
V_{BS} Supply Undervoltage Positive Going Threshold	V_{BSUV+}	5.5	6.5	7.5	V	–
V_{BS} Supply Undervoltage Negative Going Threshold	V_{BSUV-}	5.3	6.3	7.3	V	–
Output High Short Circuit Pulsed Current	I_{O+}	130	290	–	mA	$V_O = 0V$, $PW \leq 10\mu s$
Output Low Short Circuit Pulsed Current	I_{O-}	270	600	–	mA	$V_O = 15V$, $PW \leq 10\mu s$

Note: 7. The V_{IN} and I_{IN} parameters are applicable to the two logic pins: IN and SD*. The V_O and I_O parameters are applicable to the respective output pins: HO and LO.
 8. For optimal operation, it is recommended that the input pulses (IN and SD*) should have a minimum amplitude of 2.5V with a minimum pulse width of 860ns.

AC Electrical Characteristics (V_{BIAS} (V_{CC} , V_{BS}) = 15V, C_L = 1000pF, @ T_A = +25°C, unless otherwise specified.)

Parameter	Symbol	Min	Typ	Max	Unit	Condition
Turn-On Propagation Delay	t_{ON}	–	680	820	ns	$V_S = 0V$
Turn-Off Propagation Delay	t_{OFF}	–	150	220	ns	$V_S = 600V$
Shutdown Propagation Delay	t_{SD}	–	160	220	ns	–
Delay Matching, HO and LO Turn-On / Turn-Off	t_{DM}	–	–	60	ns	–
Turn-On Rise Time	t_R	–	70	170	ns	$V_S = 0V$
Turn-Off Fall Time	t_F	–	35	90	ns	$V_S = 0V$
Deadtime: $t_{DT LO-HO}$ & $t_{DT HO-LO}$	t_{DT}	300	430	550	ns	–

OBSOLETE

Timing Waveforms

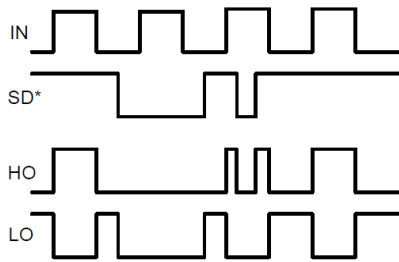

Figure 1. Input / Output Timing Diagram

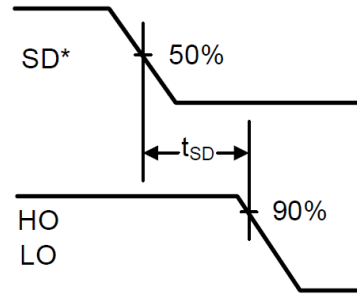

Figure 2. Shutdown Waveform Definition

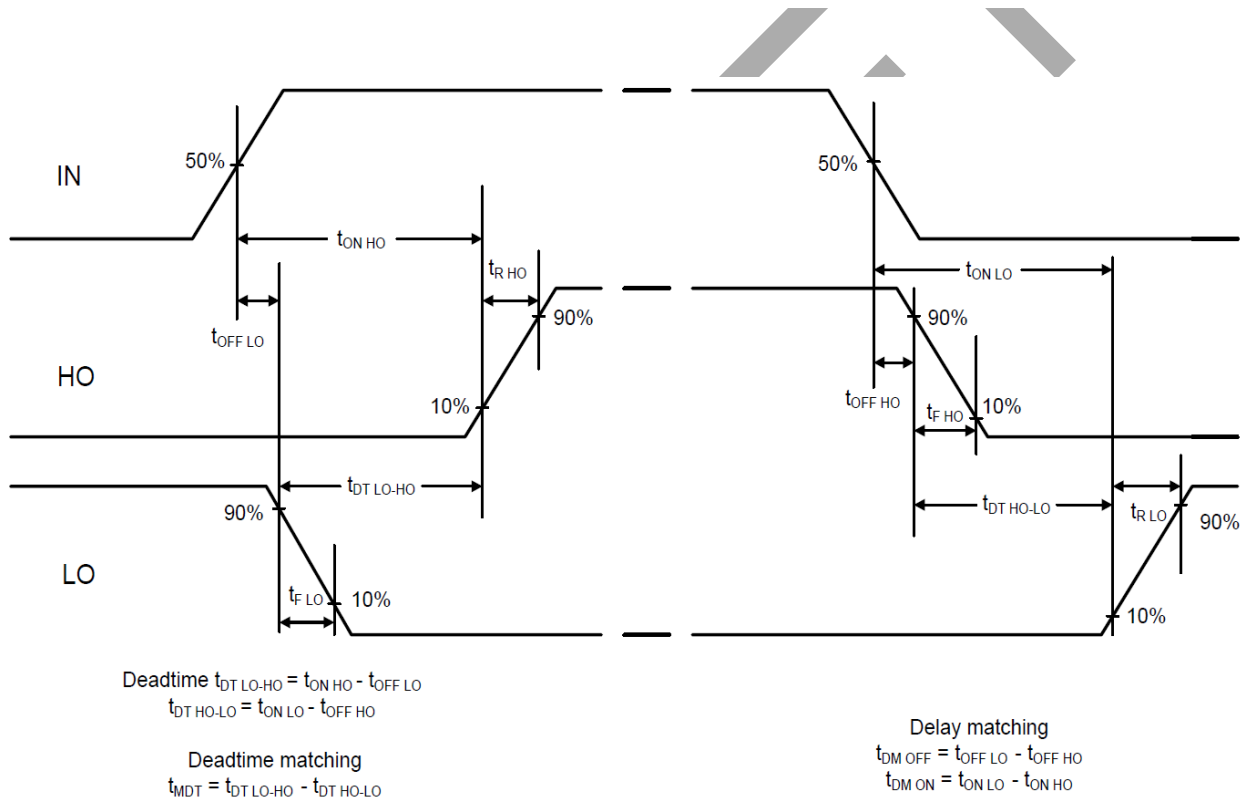

Figure 3. Switching Time Waveform Definitions

OBSOLETE - PART DISCONTINUED

Typical Performance Characteristics (@ $T_A = +25^\circ\text{C}$, unless otherwise specified.)

OBSOLETE – PART DISCONTINUED

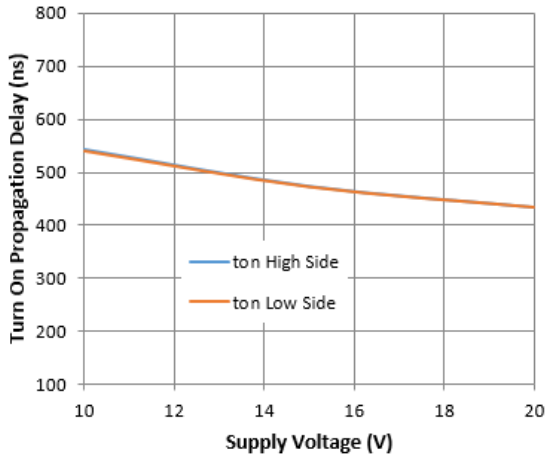

Figure 4. Turn-on Propagation Delay vs. Supply Voltage

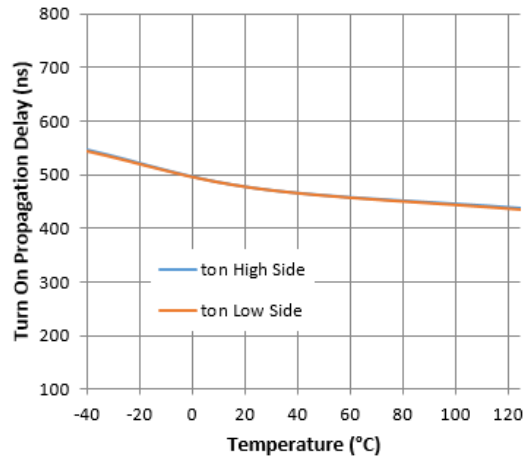

Figure 5. Turn-on Propagation Delay vs. Temperature

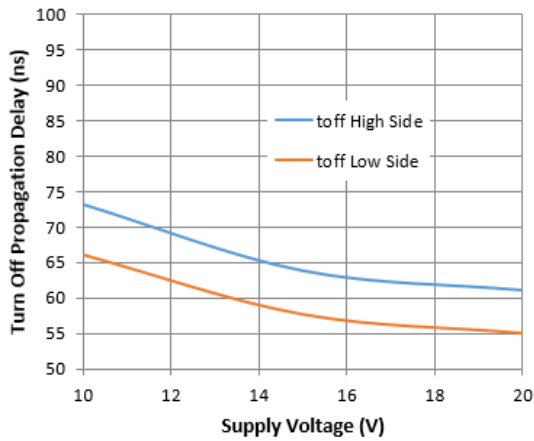

Figure 6. Turn-off Propagation Delay vs. Supply Voltage

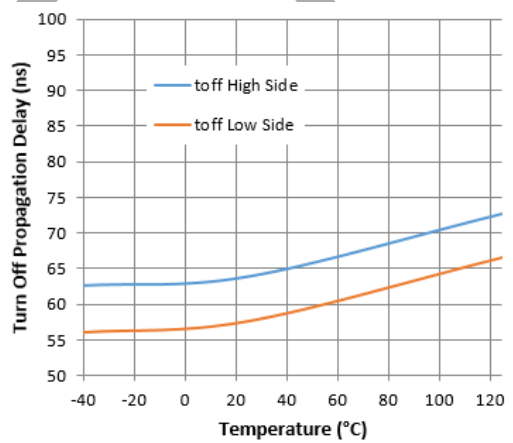

Figure 7. Turn-off Propagation Delay vs. Temperature

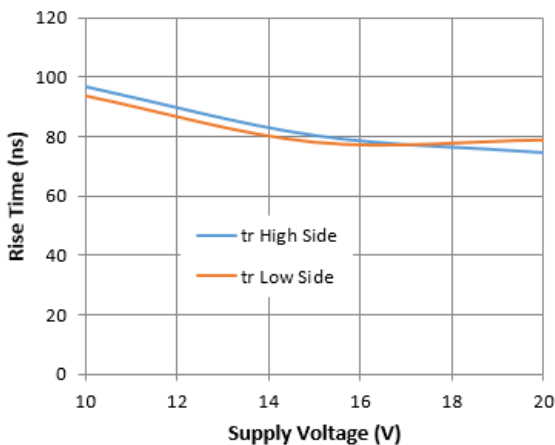

Figure 8. Rise Time vs. Supply Voltage

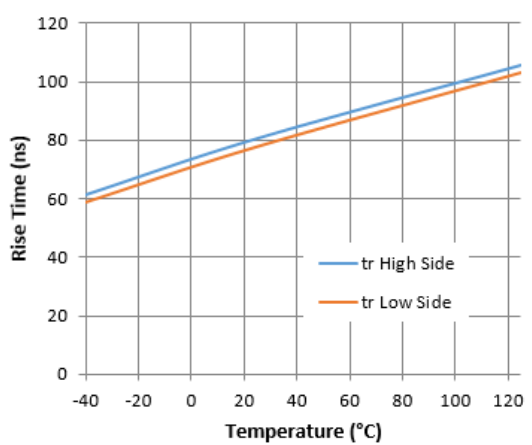

Figure 9. Rise Time vs. Temperature

Typical Performance Characteristics (continued)

OBSOLETE – PART DISCONTINUED

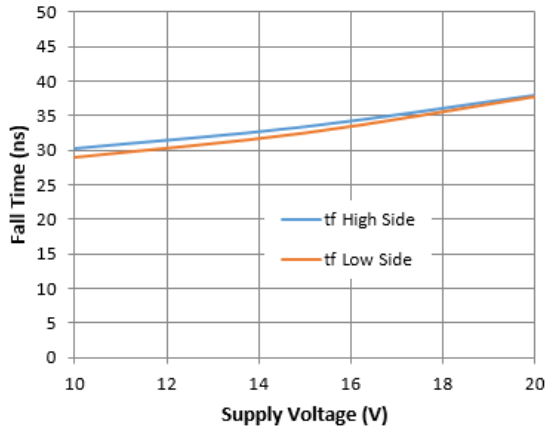

Figure 10. Fall Time vs. Supply Voltage

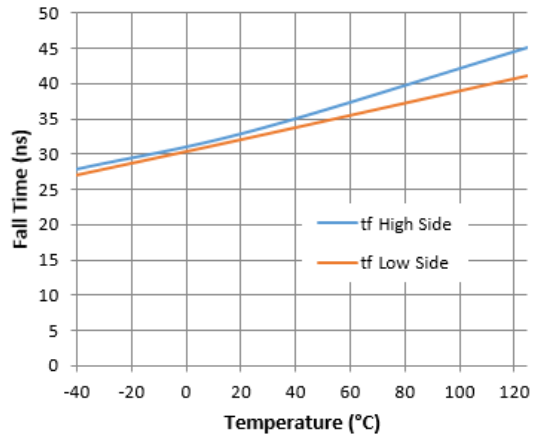

Figure 11. Fall Time vs. Temperature

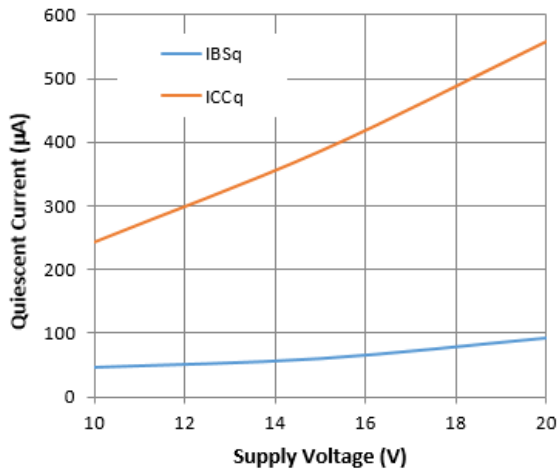

Figure 12. Quiescent Current vs. Supply Voltage

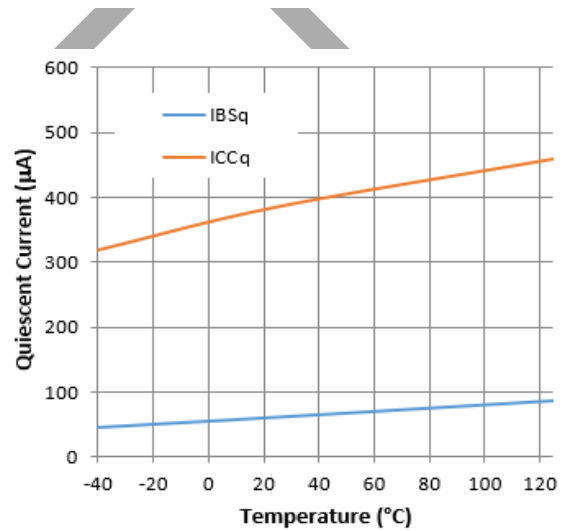

Figure 13. Quiescent Current vs. Temperature

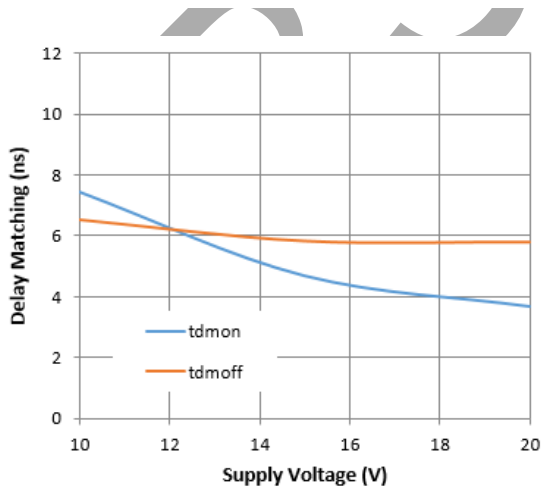

Figure 14. Delay Matching vs. Supply Voltage

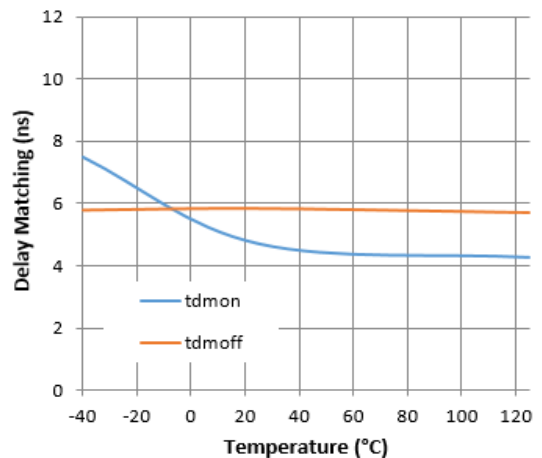

Figure 15. Delay Matching vs. Temperature

Typical Performance Characteristics (continued)

OBSOLETE – PART DISCONTINUED

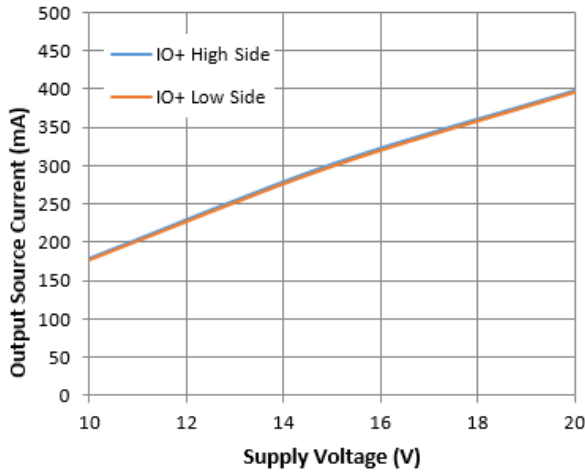

Figure 16. Output Source Current vs. Supply Voltage

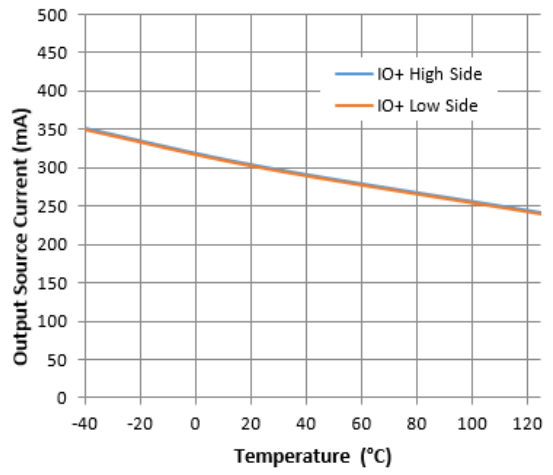

Figure 17. Output Source Current vs. Temperature

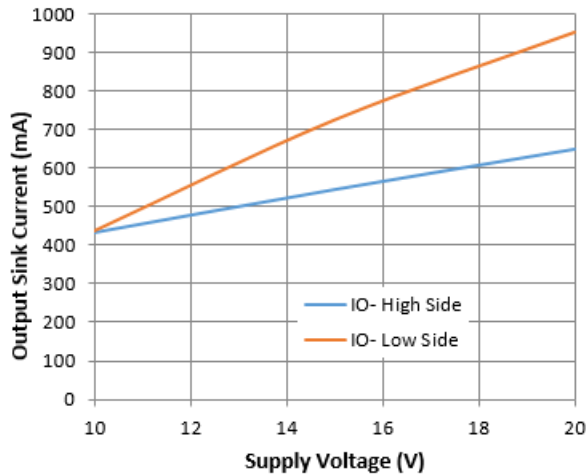

Figure 18. Output Sink Current vs. Supply Voltage

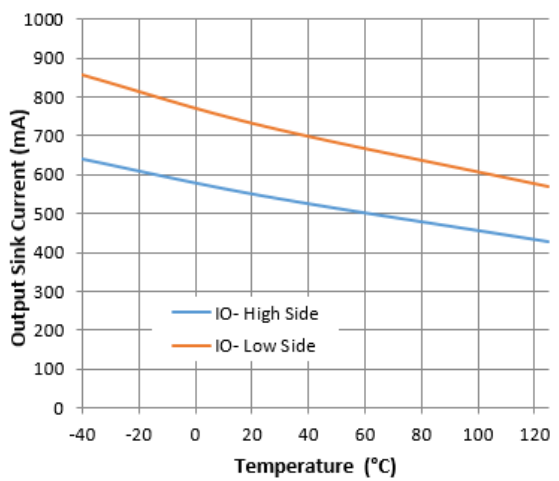

Figure 19. Output Sink Current vs. Temperature

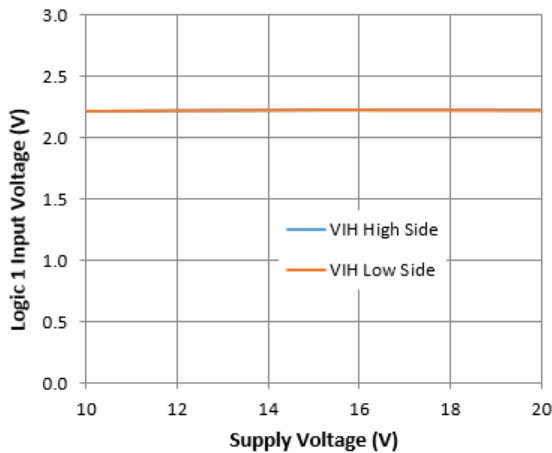

Figure 20. Logic 1 Input Voltage vs. Supply Voltage

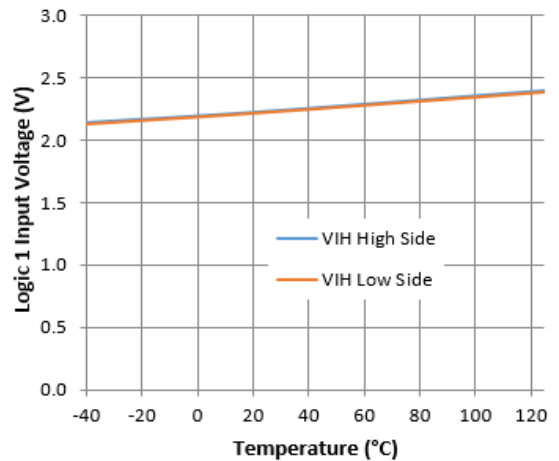

Figure 21. Logic 1 Input Voltage vs. Temperature

Typical Performance Characteristics (continued)

OBSOLETE – PART DISCONTINUED

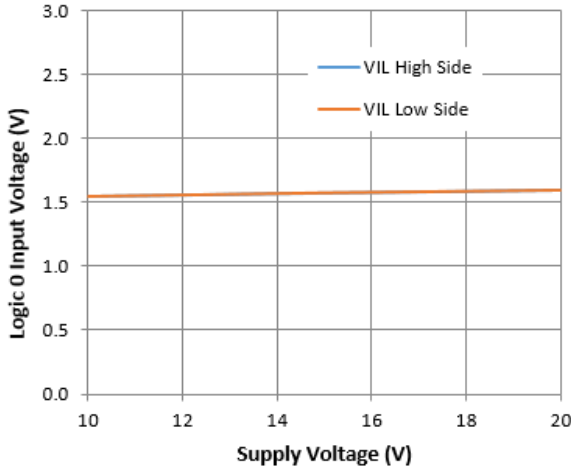

Figure 22. Logic 0 Input Voltage vs. Supply Voltage

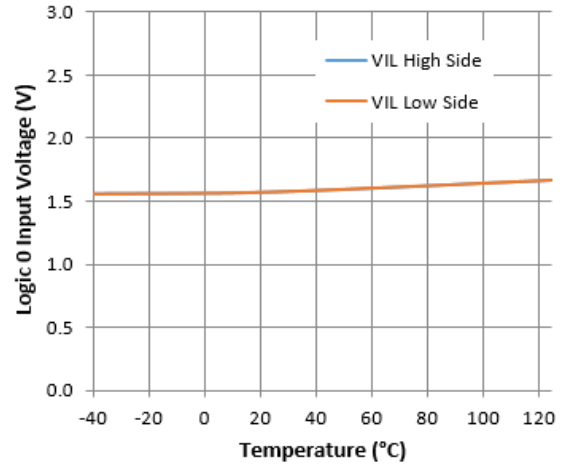

Figure 23. Logic 0 Input Voltage vs. Temperature

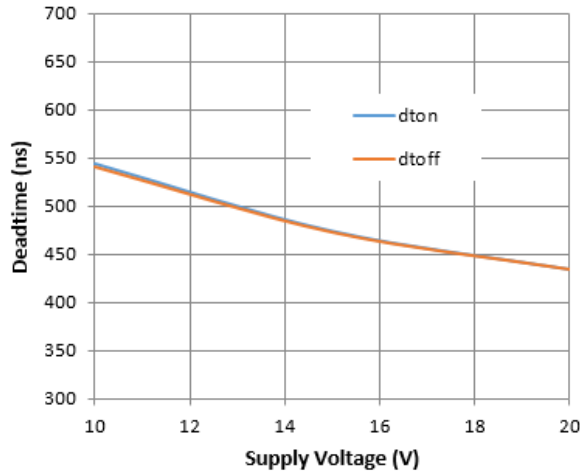

Figure 24. Deadtime vs. Supply Voltage

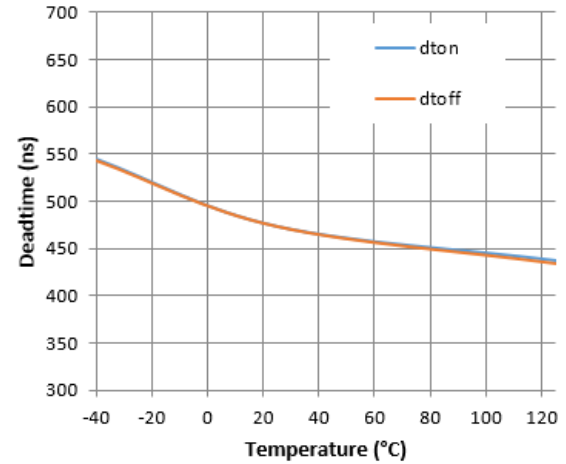

Figure 25. Deadtime vs. Temperature

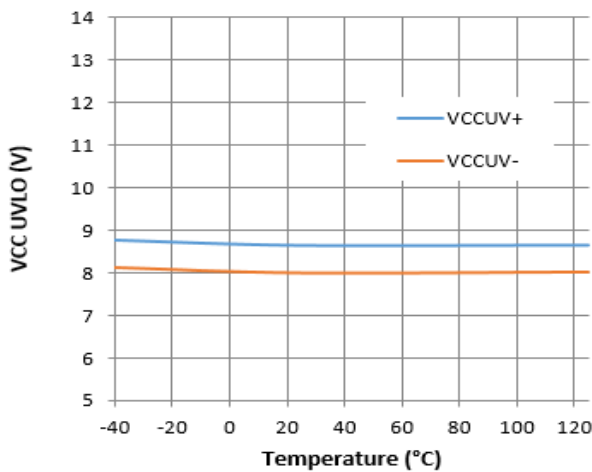

Figure 26. VCC UVLO vs. Temperature

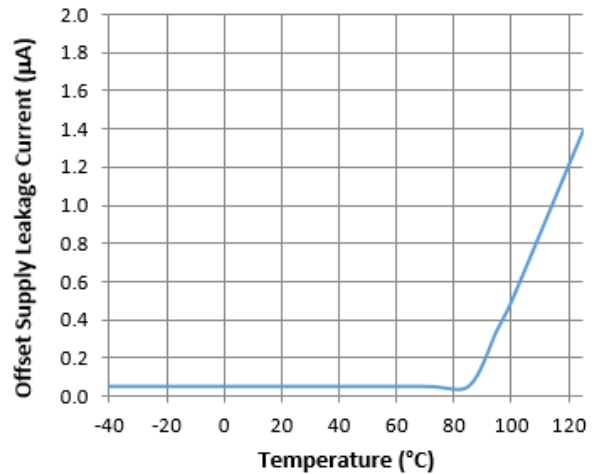
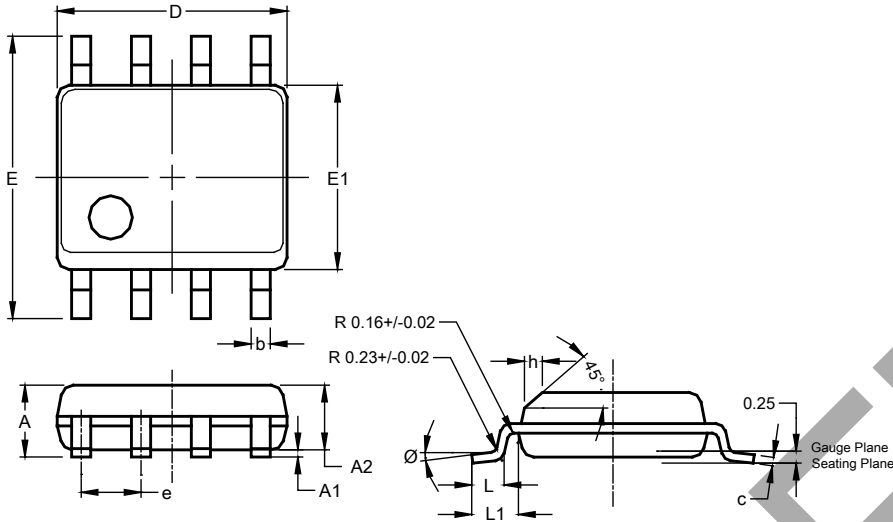

Figure 27. Offset Supply Leakage Current vs. Temperature

Package Outline Dimensions

Please see <http://www.diodes.com/package-outlines.html> for the latest version.

SO-8 (Type TH)



SO-8 (Type TH)			
Dim	Min	Max	Typ
A	1.35	1.75	--
A1	0.10	0.25	--
A2	--	--	1.45
b	0.35	0.51	--
c	0.190	0.248	--
D	4.80	5.00	4.90
E	5.80	6.20	6.00
E1	3.80	4.00	3.90
e	--	--	1.27
h	0.25	0.50	--
L	0.41	1.27	--
L1	--	--	1.04
Ø	0°	8°	--
All Dimensions in mm			

OBSOLETE - PART DISCONTINUED

Suggested Pad Layout

Please see <http://www.diodes.com/package-outlines.html> for the latest version.

SO-8 (Type TH)

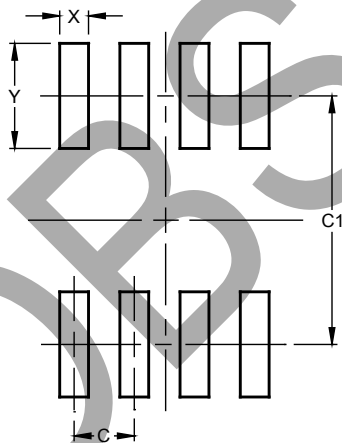

Dimensions	Value (in mm)
C	1.27
C1	5.20
X	0.60
Y	2.20

Note : For high voltage applications, the appropriate industry sector guidelines should be considered with regards to creepage and clearance distances between device Terminals and PCB tracking.

IMPORTANT NOTICE

1. DIODES INCORPORATED AND ITS SUBSIDIARIES ("DIODES") MAKE NO WARRANTY OF ANY KIND, EXPRESS OR IMPLIED, WITH REGARDS TO ANY INFORMATION CONTAINED IN THIS DOCUMENT, INCLUDING, BUT NOT LIMITED TO, THE IMPLIED WARRANTIES OF MERCHANTABILITY, FITNESS FOR A PARTICULAR PURPOSE OR NON-INFRINGEMENT OF THIRD PARTY INTELLECTUAL PROPERTY RIGHTS (AND THEIR EQUIVALENTS UNDER THE LAWS OF ANY JURISDICTION).
2. The Information contained herein is for informational purpose only and is provided only to illustrate the operation of Diodes products described herein and application examples. Diodes does not assume any liability arising out of the application or use of this document or any product described herein. This document is intended for skilled and technically trained engineering customers and users who design with Diodes products. Diodes products may be used to facilitate safety-related applications; however, in all instances customers and users are responsible for (a) selecting the appropriate Diodes products for their applications, (b) evaluating the suitability of the Diodes products for their intended applications, (c) ensuring their applications, which incorporate Diodes products, comply the applicable legal and regulatory requirements as well as safety and functional-safety related standards, and (d) ensuring they design with appropriate safeguards (including testing, validation, quality control techniques, redundancy, malfunction prevention, and appropriate treatment for aging degradation) to minimize the risks associated with their applications.
3. Diodes assumes no liability for any application-related information, support, assistance or feedback that may be provided by Diodes from time to time. Any customer or user of this document or products described herein will assume all risks and liabilities associated with such use, and will hold Diodes and all companies whose products are represented herein or on Diodes' websites, harmless against all damages and liabilities.
4. Products described herein may be covered by one or more United States, international or foreign patents and pending patent applications. Product names and markings noted herein may also be covered by one or more United States, international or foreign trademarks and trademark applications. Diodes does not convey any license under any of its intellectual property rights or the rights of any third parties (including third parties whose products and services may be described in this document or on Diodes' website) under this document.
5. Diodes products are provided subject to Diodes' Standard Terms and Conditions of Sale (<https://www.diodes.com/about/company/terms-and-conditions/terms-and-conditions-of-sales/>) or other applicable terms. This document does not alter or expand the applicable warranties provided by Diodes. Diodes does not warrant or accept any liability whatsoever in respect of any products purchased through unauthorized sales channel.
6. Diodes products and technology may not be used for or incorporated into any products or systems whose manufacture, use or sale is prohibited under any applicable laws and regulations. Should customers or users use Diodes products in contravention of any applicable laws or regulations, or for any unintended or unauthorized application, customers and users will (a) be solely responsible for any damages, losses or penalties arising in connection therewith or as a result thereof, and (b) indemnify and hold Diodes and its representatives and agents harmless against any and all claims, damages, expenses, and attorney fees arising out of, directly or indirectly, any claim relating to any noncompliance with the applicable laws and regulations, as well as any unintended or unauthorized application.
7. While efforts have been made to ensure the information contained in this document is accurate, complete and current, it may contain technical inaccuracies, omissions and typographical errors. Diodes does not warrant that information contained in this document is error-free and Diodes is under no obligation to update or otherwise correct this information. Notwithstanding the foregoing, Diodes reserves the right to make modifications, enhancements, improvements, corrections or other changes without further notice to this document and any product described herein. This document is written in English but may be translated into multiple languages for reference. Only the English version of this document is the final and determinative format released by Diodes.
8. Any unauthorized copying, modification, distribution, transmission, display or other use of this document (or any portion hereof) is prohibited. Diodes assumes no responsibility for any losses incurred by the customers or users or any third parties arising from any such unauthorized use.

Copyright © 2021 Diodes Incorporated

www.diodes.com

OBSOLETE - PART DISCONTINUED