

**SURFACE MOUNT
UNIDIRECTIONAL AND BIDIRECTIONAL
TRANSIENT VOLTAGE SUPPRESSORS**

STAND-OFF VOLTAGE - **5.0 to 220** Volts
POWER DISSIPATION - **3000** WATTS

FEATURES

- For surface mounted applications
- Reliable low cost construction utilizing molded plastic technique
- Typical IR less than 1uA above 10V
- Fast response time: typically less than 1.0ns for Uni-direction, less than 5.0ns for Bi-direction, from 0 Volts to BV min
- RoHS compliant
- Qualified to AEC-Q101 Rev_C
- IEC6100-4-2, >±30KV(air); >±30KV(Contact)

MECHANICAL DATA

- Case : Molded plastic
- Case Material: Molding compound, UL Flammability classification 94V-0, (No Br. Sb. Cl.) "Halogen-free".
- Polarity : by cathode band denotes uni-directional device none cathode band denotes bi-directional device
- Weight : 0.007 ounces, 0.21 gram

SMC

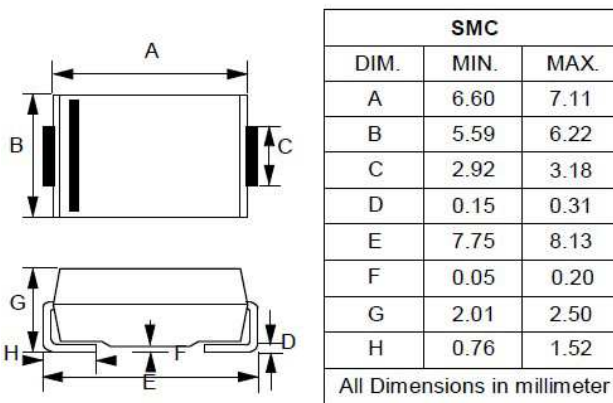

MAXIMUM RATINGS AND ELECTRICAL CHARACTERISTICS

Ratings at 25°C ambient temperature unless otherwise specified.

CHARACTERISTICS	SYMBOLS	VALUE	UNIT
PEAK POWER DISSIPATION AT T _J = 25°C , T _P = 1ms (Note 1)	P _{PK}	3000	W
Peak Forward Surge Current 8.3ms single half sine-wave @T _J =25 °C (Note 2)	I _{FSM}	300	A
Steady State Power Dissipation at T _L =120°C lead lengths 0.375" (9.5mm) , see fig. 6	P _{M(AV)}	2.0	W
Operating Temperature Range	T _J	-55 to +175	C
Storage Temperature Range	T _{STG}	-55 to +175	C

NOTES : 1. Non-repetitive current pulse, per Fig. 3 and derated above T_J= 25°C per Fig.1.
2. Only for unidirectional units.

REV. 19, Jan-2017, KSIC03

FIG. 1 - PULSE DERATING CURVE

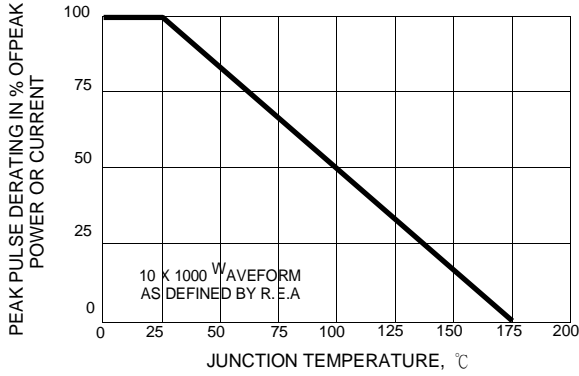

FIG.2 - MAXIMUM NON-REPETITIVE SURGE CURRENT

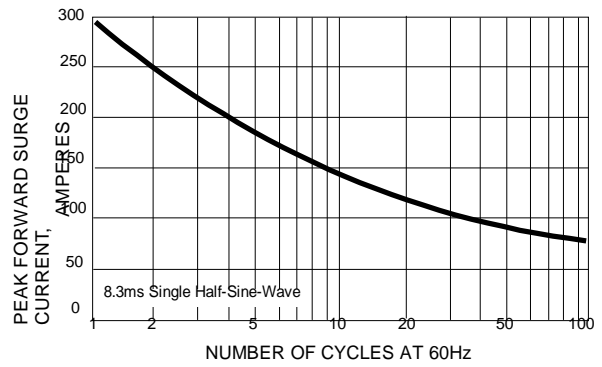

FIG.3 - PULSE WAVEFORM

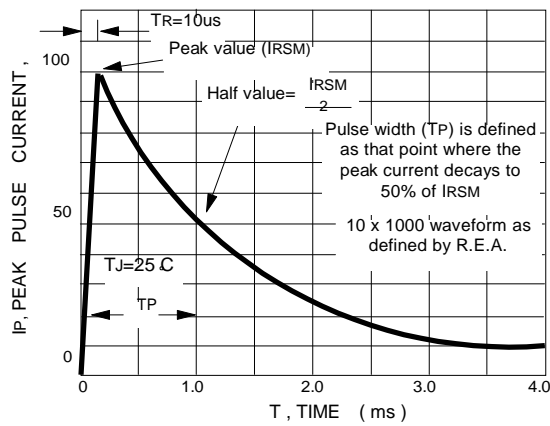

FIG.4 - TYPICAL JUNCTION CAPACITANCE

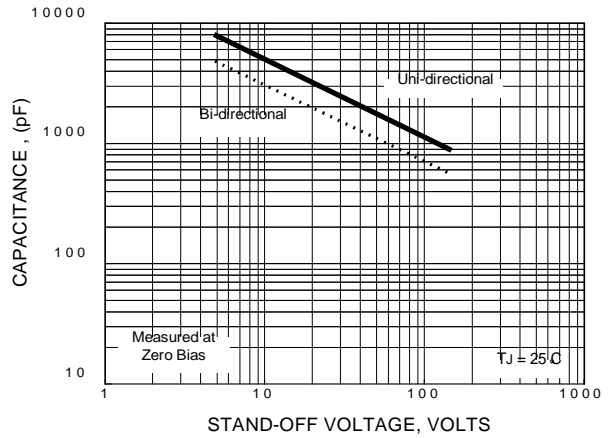

FIG.5 - PULSE RATING CURVE

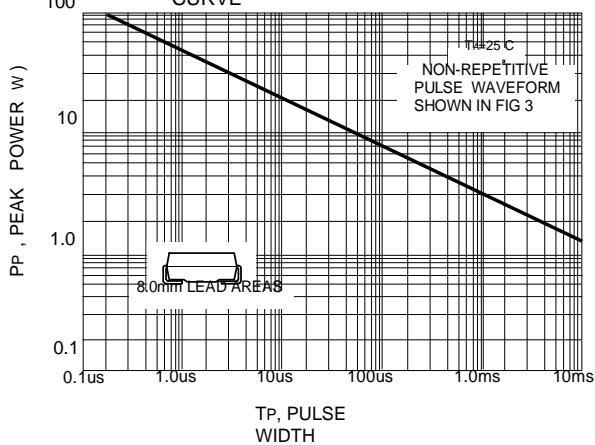
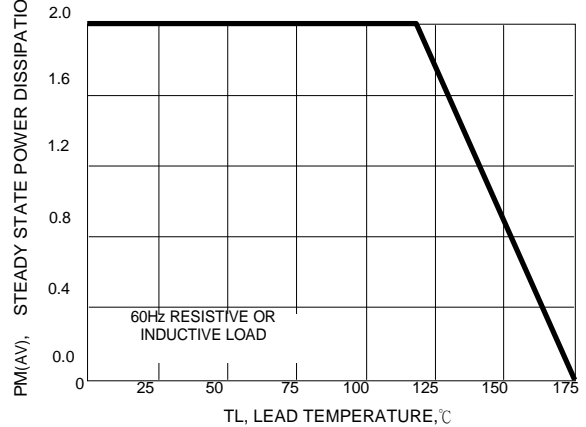

FIG.6 - STEADY STATE POWER DERATING CURVE



Type Number	Type Number	Device Marking code		Reverse Standoff Voltage	Breakdown Voltage BV Volts @It			Max. Reverse Leakage @VR	Max. Clamping Voltage @Ipp	Max. Peak Pulse Current
		(UNI)	(BI)		VR (V)	Min (V)	Max (V)			
3.0SMCJ5.0A	3.0SMCJ5.0CA	HDE	IDE	5.0	6.40	7.07	10	1000.0	9.2	326.1
*3.0SMCJ5.0A6	N/A	HDE6	---	5.0	6.40	7.07	10	1000.0	9.2	326.1
3.0SMCJ6.0A	3.0SMCJ6.0CA	HDG	IDG	6.0	6.67	7.37	10	1000.0	10.3	291.3
3.0SMCJ6.5A	3.0SMCJ6.5CA	HDK	IDK	6.5	7.22	7.98	10	500.0	11.2	267.9
3.0SMCJ7.0A	3.0SMCJ7.0CA	HDM	IDM	7.0	7.78	8.60	10	200.0	12.0	250.0
3.0SMCJ7.5A	3.0SMCJ7.5CA	HDP	IDP	7.5	8.33	9.21	1	100.0	12.9	232.6
3.0SMCJ8.0A	3.0SMCJ8.0CA	HDR	IDR	8.0	8.89	9.83	1	50.0	13.6	220.6
3.0SMCJ8.5A	3.0SMCJ8.5CA	HDT	IDT	8.5	9.44	10.43	1	25.0	14.4	208.3
3.0SMCJ9.0A	3.0SMCJ9.0CA	HDV	IDV	9.0	10.0	11.05	1	10.0	15.4	194.8
3.0SMCJ10A	3.0SMCJ10CA	HDX	IDX	10.0	11.1	12.27	1	2.0	17.0	176.5
3.0SMCJ11A	3.0SMCJ11CA	HDZ	IDZ	11.0	12.2	13.5	1	2.0	18.2	164.8
3.0SMCJ12A	3.0SMCJ12CA	HEE	IEE	12.0	13.3	14.7	1	2.0	19.9	150.8
3.0SMCJ13A	3.0SMCJ13CA	HEG	IEG	13.0	14.4	15.9	1	2.0	21.5	139.5
3.0SMCJ14A	3.0SMCJ14CA	HEK	IEK	14.0	15.6	17.2	1	2.0	23.2	129.3
3.0SMCJ15A	3.0SMCJ15CA	HEM	IEM	15.0	16.7	18.5	1	2.0	24.2	124.0
3.0SMCJ16A	3.0SMCJ16CA	HEP	IEP	16.0	17.8	19.7	1	2.0	26.0	115.4
3.0SMCJ17A	3.0SMCJ17CA	HER	IER	17.0	18.9	20.9	1	2.0	27.6	108.7
3.0SMCJ18A	3.0SMCJ18CA	HET	IET	18.0	20.0	22.1	1	2.0	29.2	102.7
3.0SMCJ20A	3.0SMCJ20CA	HEV	IEV	20.0	22.2	24.5	1	2.0	32.4	92.6
*3.0SMCJ20A6	N/A	HEV6	---	20.0	22.2	24.5	1	5.0	32.4	92.6
3.0SMCJ22A	3.0SMCJ22CA	HEX	IEX	22.0	24.4	27.0	1	2.0	35.5	84.5
3.0SMCJ24A	3.0SMCJ24CA	HEZ	IEZ	24.0	26.7	29.5	1	2.0	38.9	77.1
*3.0SMCJ24A6	N/A	HEZ6	---	24.5	---	29.5	1	2.0	38.9	84.8
3.0SMCJ26A	3.0SMCJ26CA	HFE	IFE	26.0	28.9	31.9	1	2.0	42.1	71.3
*3.0SMCJ26A6	N/A	HFE6	---	26.0	28.9	31.9	1	2.0	42.1	71.3
3.0SMCJ28A	3.0SMCJ28CA	HFG	IFG	28.0	31.1	34.4	1	2.0	45.4	66.1
*3.0SMCJ28A6	N/A	HFG6	---	28.0	31.1	34.4	1	2.0	45.4	66.1
3.0SMCJ30A	3.0SMCJ30CA	HFK	IFK	30.0	33.3	36.8	1	2.0	48.4	62.0
3.0SMCJ33A	3.0SMCJ33CA	HFM	IFM	33.0	36.7	40.6	1	2.0	53.3	56.3
3.0SMCJ36A	3.0SMCJ36CA	HFP	IFP	36.0	40.0	44.2	1	2.0	58.1	51.6
3.0SMCJ40A	3.0SMCJ40CA	HFR	IFR	40.0	44.4	49.1	1	2.0	64.5	46.5
3.0SMCJ43A	3.0SMCJ43CA	HFT	IFT	43.0	47.8	52.8	1	2.0	69.4	43.2
3.0SMCJ45A	3.0SMCJ45CA	HFV	IFV	45.0	50.0	55.3	1	2.0	72.7	41.3
3.0SMCJ48A	3.0SMCJ48CA	HFX	IFX	48.0	53.3	58.9	1	2.0	77.4	38.8
3.0SMCJ51A	3.0SMCJ51CA	HFZ	IFZ	51.0	56.7	62.7	1	2.0	82.4	36.4
3.0SMCJ54A	3.0SMCJ54CA	HGE	IGE	54.0	60.0	66.3	1	2.0	87.1	34.4
3.0SMCJ58A	3.0SMCJ58CA	HGG	IGG	58.0	64.4	71.2	1	2.0	93.6	32.1
3.0SMCJ60A	3.0SMCJ60CA	HGK	IGK	60.0	66.7	73.7	1	2.0	96.8	31.0
3.0SMCJ64A	3.0SMCJ64CA	HGM	IGM	64.0	71.1	78.6	1	2.0	103.0	29.1
3.0SMCJ70A	3.0SMCJ70CA	HGP	IGP	70.0	77.8	86.0	1	2.0	113.0	26.5
3.0SMCJ75	3.0SMCJ75C	HGQ	IGQ	75.0	83.3	101.8	1	2.0	134.0	22.4
3.0SMCJ75A	3.0SMCJ75CA	HGR	IGR	75.0	83.3	92.1	1	2.0	121.0	24.8
3.0SMCJ78A	3.0SMCJ78CA	HGT	IGT	78.0	86.7	95.8	1	2.0	126.0	23.8
3.0SMCJ85A	3.0SMCJ85CA	HGV	IGV	85.0	94.4	104.3	1	2.0	137.0	21.9
3.0SMCJ90A	3.0SMCJ90CA	HGX	IGX	90.0	100.0	110.5	1	2.0	146.0	20.5
3.0SMCJ100A	3.0SMCJ100CA	HGZ	IGZ	100.0	111.0	122.7	1	2.0	162.0	18.5
3.0SMCJ110A	3.0SMCJ110CA	HHE	IHE	110.0	122.0	134.8	1	2.0	177.0	16.9
3.0SMCJ120A	3.0SMCJ120CA	HHG	IHG	120.0	133.0	147.0	1	2.0	193.0	15.5
3.0SMCJ130A	3.0SMCJ130CA	HHK	IHK	130.0	144.0	159.2	1	2.0	209.0	14.4

Type Number	Type Number	Device Marking code		Reverse Standoff Voltage	Breakdown Voltage BV Volts @It			Max. Reverse Leakage @VR	Max. Clamping Voltage @Ipp	Max. Peak Pulse Current
		(UNI)	(BI)		VR (V)	Min (V)	Max (V)			
3.0SMCJ150A	3.0SMCJ150CA	HHM	IHM	150.0	167.0	184.6	1	2.0	243.0	12.3
3.0SMCJ160A	3.0SMCJ160CA	HHP	IHP	160.0	178.0	196.7	1	2.0	259.0	11.6
3.0SMCJ170A	3.0SMCJ170CA	HHR	IHR	170.0	189.0	208.9	1	2.0	275.0	10.9
3.0SMCJ180A	3.0SMCJ180CA	HHT	IHT	180.0	198.0	218.8	1	2.0	292.0	10.3
3.0SMCJ190A	3.0SMCJ190CA	HHV	IHV	190.0	209.0	231.0	1	2.0	308.0	9.7
3.0SMCJ200A	3.0SMCJ200CA	HHX	IHX	200.0	220.0	243.2	1	2.0	324.0	9.3
3.0SMCJ210A	3.0SMCJ210CA	HHZ	IHZ	210.0	231.0	255.3	1	2.0	340.0	8.8
3.0SMCJ220A	3.0SMCJ220CA	HIE	IIE	220.0	242.0	267.5	1	2.0	356.0	8.4

NOTES:

- 1) For bidirectional devices having VR of 10 volts and under, the IR limit is doubled .
- 2) Mark "***" denote that comply IEC 61000-4-5 Severity levels, 6KV. For data lines requiring a 42Ω source impedance, the short-circuit current waveform is defined as 8/20us.

Important Notice and Disclaimer

LSC reserves the right to make changes to this document and its products and specifications at any time without notice. Customers should obtain and confirm the latest product information and specifications before final design, purchase or use.

LSC makes no warranty, representation or guarantee regarding the suitability of its products for any particular purpose, nor does LSC assume any liability for application assistance or customer product design. LSC does not warrant or accept any liability with products which are purchased or used for any unintended or unauthorized application.

No license is granted by implication or otherwise under any intellectual property rights of LSC.

LSC products are not authorized for use as critical components in life support devices or systems without express written approval of LSC.